

IEC Appliance Inlet C14 with Filter, Fuseholder 1- or 2-pole (5x20 mm or 6.3x32 mm), Line Switch 1- or 2-pole, Voltage Selector (Step)

Standard- or Medical-Filter



Fuse drawer must be ordered separately (see accessories).



Description

- Panel Mount:
Screw-on mounting from front side
- 5 Functions:
Appliance Inlet, Line Switch, Fuseholder with interchangeable fuse drawer for Fuse-links 5x20 mm or 6.3x32 mm, with or without voltage selector (step switch), Line filter in standard and medical version
- Quick connect terminals 4.8 x 0.8 mm

Approvals

- VDE Certificate Number: 40004665 (FKSO, FKSP, FKSU, FKSU)
- UL File Number: E72928 (FKSO, FKSP, FKSU, FKSU)

Characteristics

- All single elements are already wired
- The fuse drawer "Fingerrip" can be removed by hand
For added safety "Extra-Safe" fuse drawers are available
Fuse drawer meets requirements of medical standard IEC/EN 60601-1
The fuse drawer can only be opened with the aid of a tool
The fuseholder is accessible from the equipment front
- Suitable for use in equipment according to IEC/UL 60950
Suitable for use in medical equipment according to IEC/UL 60601-1

References

- Alternative: version without line filter [KD](#)
- Alternative: Standard version

Weblinks

[pdf-datasheet](#), [html-datasheet](#), [General Product Information](#), [RoHS](#), [CHINA-RoHS](#), [REACH](#), [Mating Connectors](#), [e-Shop](#), [SCHURTER-Stock-Check](#), [Distributor-Stock-Check](#), [Accessories](#), [Wire Harnessing](#)

Newly available variants corresponding to V-Lock mating cordset. The connector is equipped with a notch intended for use with the latching cordset. The cord latching system prevents against accidental removal of the cordset.

Technical Data

Ratings IEC	1 - 10A @ Ta 40 °C / 250VAC; 50Hz	Appliance-Inlet/-Outlet	C14 acc. to IEC 60320, UL 498, CSA C22.2 no. 42 (for cold conditions) pin-temperature 70 °C, 10A, Protection Class I
Ratings UL/CSA	1 - 10A @ Ta 40 °C / 125VAC; 60Hz	Fuseholder	1 or 2 pole, Shocksafe category PC2 acc. to IEC 60127-6, for fuse-links 5 x 20 or 6.3 x 32mm
Leakage Current	standard < 0.5mA (250V / 60Hz) medical < 5 µA (250 V / 60 Hz)	Rated Power Acceptance @ Ta 23 °C	5 x 20: 2.5W (1 pole)/ 2W (2-pole) per pole 6.3 x 32: 3.15W (1 pole)/ 2.5W (2-pole) per pole
Dielectric Strength	> 1.7kVDC between L-N > 2.7kVDC between L/N-PE Test voltage (2 sec)	Power Acceptance @ Ta > 23°C	Admissible power acceptance at higher ambient temperature see derating curves
Allowable Operation Temp.	-25°C to 85°C	Line Switch	2-pole, non-illuminated, acc. to IEC 61058-1 Technical Details
Climatic Category	25/085/21 acc. to IEC 60068-1	Voltage Selector	optional, step, 2-4 digits
Degree of Protection	from front side IP 40 acc. to IEC 60529	Line Filter	Standard and Medical Version, IEC 60939, UL 1283, CSA C22.2 no. 8 Technical Details
Protection Class	Suitable for appliances with protection class I acc. to IEC 61140	MTBF	> 1'200'000h acc. to MIL-HB-217 F
Terminal	Quick connect terminals 4.8 x 0.8 mm		
Panel Thickness s	Screw: max 8 mm Mounting screw torque max 0.5Nm		
Material: Housing	Thermoplastic, black, UL 94V-0		

Dimension
CD

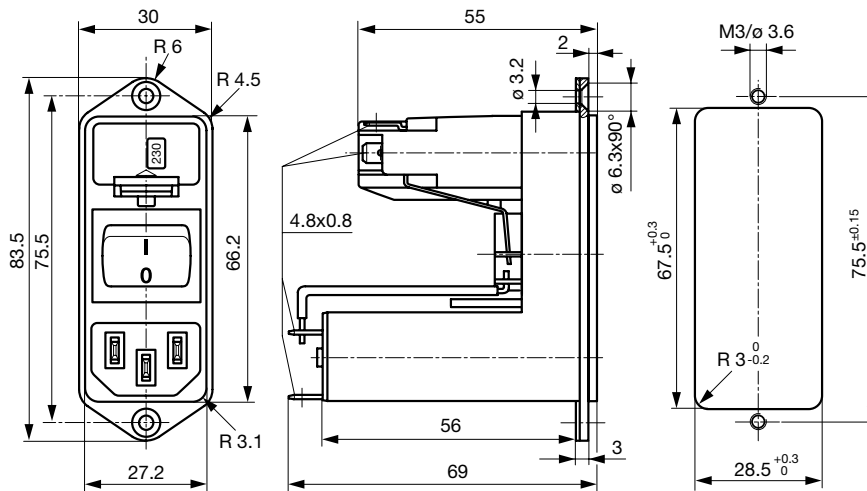

Technical Data of Filter-Components

Rated Current [A]	Filter-Type	Inductances L [mH]	Capacitance CX [nF]	Capacitance CY [nF]	R [M Ω]
1	Standard Version	2 x 10	68	2.2	-
2	Standard Version	2 x 4	68	2.2	-
4	Standard Version	2 x 1.5	68	2.2	-
6	Standard Version	2 x 0.8	68	2.2	-
10	Standard Version	2 x 0.3	68	2.2	-
1	Medical Version (M5)	2 x 10	68	-	1
2	Medical Version (M5)	2 x 4	68	-	1
4	Medical Version (M5)	2 x 1.5	68	-	1
6	Medical Version (M5)	2 x 0.8	68	-	1
10	Medical Version (M5)	2 x 0.3	68	-	1
2	Medical (M80)	2 x 4	68	0.47	1
4	Medical (M80)	2 x 1.5	68	0.47	1
10	Medical (M80)	2 x 0.3	68	0.47	1

Diagrams

Standard version
with voltage selector

Medical version
with voltage selector

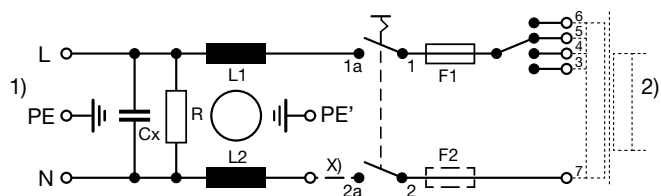
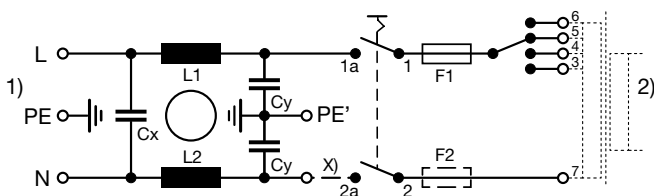

1) Line
2) Load
x) External connection to be made by the customer

1) Line
2) Load
x) External connection to be made by the customer

Derating Curves

Fuses

5 x 20 mm (1-pole)

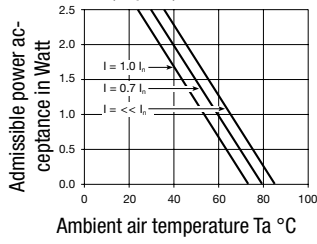

Fuses

5 x 20 mm (2-pole, per pole)

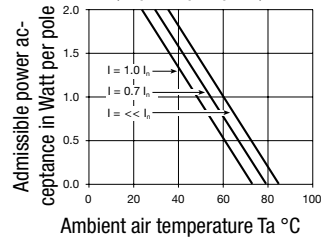

Fuses

6.3 x 32 mm (1-pole)

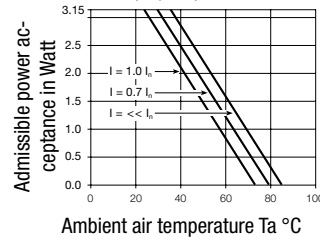

Fuses

6.3 x 32 mm (2-pole, per pole)

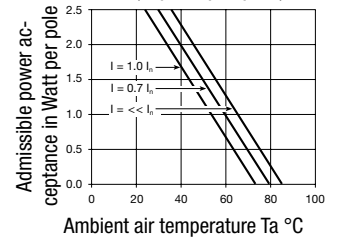

Attenuation Loss

--- differential mode _____ common mode

Standard version

1 A

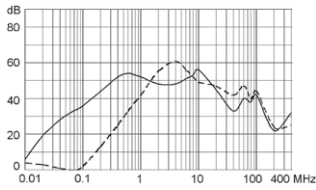

2 A

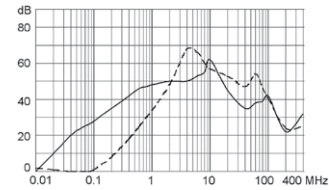

4 A

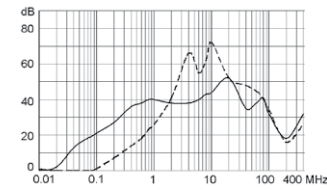

6 A

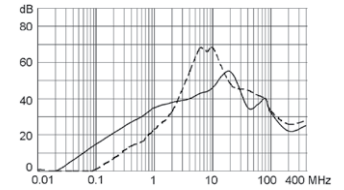

10 A

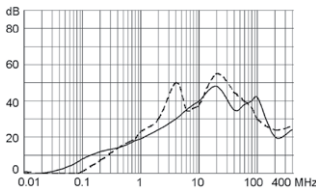

Medical version (M5)

1 A

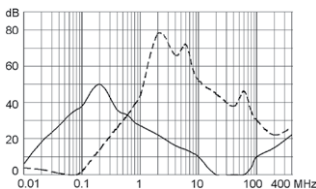

2 A

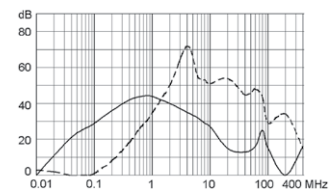

4 A

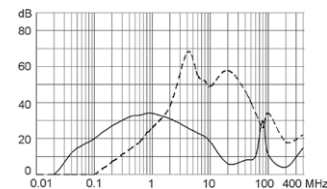

6 A

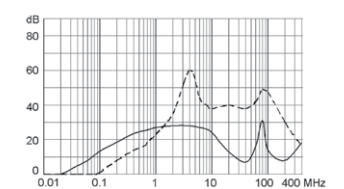

10 A

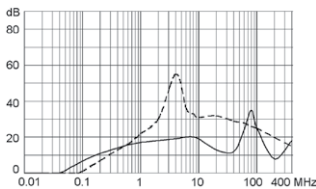

All Variants

Type	Rated Current [A]	Filter-Type	Fuseholder	Line Switch	Voltage Selector	Order Number	
CD	1	Standard Version	1-pole	2-pole	-	CD11.1501.151	■
CD	2	Standard Version	1-pole	2-pole	-	CD21.1501.151	■
CD	4	Standard Version	1-pole	2-pole	-	CD31.1501.151	
CD	6	Standard Version	1-pole	2-pole	-	CD41.1501.151	
CD	10	Standard Version	1-pole	2-pole	-	CD61.1501.151	
CD	1	Standard Version	1-pole	2-pole	2-4 digits	CD11.4501.151	
CD	2	Standard Version	1-pole	2-pole	2-4 digits	CD21.4501.151	
CD	4	Standard Version	1-pole	2-pole	2-4 digits	CD31.4501.151	■
CD	6	Standard Version	1-pole	2-pole	2-4 digits	CD41.4501.151	
CD	10	Standard Version	1-pole	2-pole	2-4 digits	CD61.4501.151	
CD	1	Standard Version	2-pole	2-pole	-	CD14.1101.151	■
CD	2	Standard Version	2-pole	2-pole	-	CD24.1101.151	■
CD	4	Standard Version	2-pole	2-pole	-	CD34.1101.151	■
CD	6	Standard Version	2-pole	2-pole	-	CD44.1101.151	■
CD	10	Standard Version	2-pole	2-pole	-	CD64.1101.151	■
CD	1	Standard Version	2-pole	2-pole	2-4 digits	CD14.4101.151	■
CD	2	Standard Version	2-pole	2-pole	2-4 digits	CD24.4101.151	■
CD	4	Standard Version	2-pole	2-pole	2-4 digits	CD34.4101.151	■
CD	6	Standard Version	2-pole	2-pole	2-4 digits	CD44.4101.151	■
CD	10	Standard Version	2-pole	2-pole	2-4 digits	CD64.4101.151	
CD	6	Medical Version (M5)	2-pole	2-pole	-	CDE4.1101.151	■
CD	1	Medical Version (M5)	2-pole	2-pole	2-4 digits	CDG4.4101.151	
CD	2	Medical Version (M5)	2-pole	2-pole	2-4 digits	CDA4.4101.151	■
CD	4	Medical Version (M5)	2-pole	2-pole	2-4 digits	CDC4.4101.151	■
CD	6	Medical Version (M5)	2-pole	2-pole	2-4 digits	CDE4.4101.151	■
CD	6	Medical Version (M5)	2-pole	2-pole	2-4 digits	CDE4.4101.151.21	
CD	10	Medical Version (M5)	2-pole	2-pole	2-4 digits	CDL4.4101.151	■
CD	2	Medical (M80)	2-pole	2-pole	2-4 digits	CDB4.4101.151	
CD	4	Medical (M80)	2-pole	2-pole	2-4 digits	CDD4.4101.151	
CD	10	Medical (M80)	2-pole	2-pole	2-4 digits	CDM4.4101.151	
CD	10	Medical (M80)	2-pole	2-pole	2-4 digits	CDM4.4101.151.21	

■ Most Popular.

Availability for all products can be searched real-time: <http://www.schurter.com/en/Stock-Check/Stock-Check-SCHURTER>

Suffix ".21" corresponds to the version with V-Lock mating cordset. The connector is equipped with a notch intended for use with the latching cordset. The cord latching system prevents against accidental removal of the cordset.

Packaging unit 10 Pcs

Required Accessory

Description



Fusedrawer 3
Fusedrawer for Fuse Links 5x20 mm resp. 6.3x32 mm

Accessories

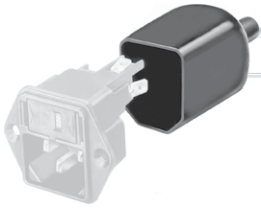

Assorted Covers
Rear Cover



Wire Harness
Wire harness for SCHURTER products



Cord retaining kits
Cord retaining strain relief

Mating Outlets/Connectors

Category / Description

Appliance Outlet Overview complete



IEC Appliance Outlet F, Screw-on Mounting, Front Side, Solder Terminal	4787
IEC Appliance Outlet F, Snap-in Mounting, Front Side, Solder or Quick-connect Terminal	4788
IEC Appliance Outlet F or H, Screw-on Mounting, Front Side, Solder, PCB or Quick-connect Terminal	5091

Appliance Outlet further types to CD

Connector Overview complete



IEC Connector C15A, Rewireable, Straight	0102
IEC Connector C15A, Rewireable, Straight	0102-G
IEC Connector C15A, Rewireable, Angled	0112
IEC Connector C13, Rewireable, Angled	4012
IEC Connector C13, Rewireable, Straight	4022

Connector further types to CD

Mating Outlets/Connectors shuttered

Power Cord Overview complete



Overview Power Supply Cord with IEC Connector C13, V-Lock, straight	VAC13KS
---	---------

Power Cord further types to CD