



FDV303N

Digital FET, N-Channel

General Description

These N-Channel enhancement mode field effect transistors are produced using Fairchild's proprietary, high cell density, DMOS technology. This very high density process is tailored to minimize on-state resistance at low gate drive conditions. This device is designed especially for application in battery circuits using either one lithium or three cadmium or NMH cells. It can be used as an inverter or for high-efficiency miniature discrete DC/DC conversion in compact portable electronic devices like cellular phones and pagers. This device has excellent on-state resistance even at gate drive voltages as low as 2.5 volts.

Features

- 25 V, 0.68 A continuous, 2 A Peak.
 $R_{DS(ON)} = 0.45 \Omega @ V_{GS} = 4.5 V$
 $R_{DS(ON)} = 0.6 \Omega @ V_{GS} = 2.7 V.$
- Very low level gate drive requirements allowing direct operation in 3V circuits. $V_{GS(th)} < 1V.$
- Gate-Source Zener for ESD ruggedness.>6kV Human Body Model
- Compact industry standard SOT-23 surface mount package.
- Alternative to TN0200T and TN0201T.



Mark:303

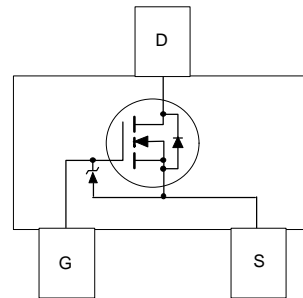
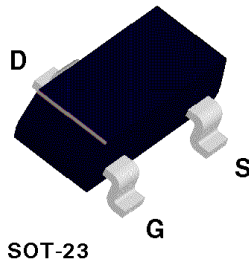

Absolute Maximum Ratings $T_A = 25^\circ C$ unless otherwise noted

Symbol	Parameter	FDV303N	Units
V_{DSS}	Drain-Source Voltage, Power Supply Voltage	25	V
V_{GSS}	Gate-Source Voltage, V_{IN}	8	V
I_D	Drain/Output Current - Continuous	0.68	A
	- Pulsed	2	
P_D	Maximum Power Dissipation	0.35	W
T_J, T_{STG}	Operating and Storage Temperature Range	-55 to 150	$^\circ C$
ESD	Electrostatic Discharge Rating MIL-STD-883D Human Body Model (100pf / 1500 Ohm)	6.0	kV

THERMAL CHARACTERISTICS

$R_{\theta JA}$	Thermal Resistance, Junction-to-Ambient	357	$^\circ C/W$
-----------------	---	-----	--------------

Electrical Characteristics ($T_A = 25\text{ }^\circ\text{C}$ unless otherwise noted)

Symbol	Parameter	Conditions	Min	Typ	Max	Units
OFF CHARACTERISTICS						
BV_{DSS}	Drain-Source Breakdown Voltage	$V_{GS} = 0\text{ V}$, $I_D = 250\text{ }\mu\text{A}$	25			V
$\Delta BV_{DSS}/\Delta T_J$	Breakdown Voltage Temp. Coefficient	$I_D = 250\text{ }\mu\text{A}$, Referenced to $25\text{ }^\circ\text{C}$		26		mV / $^\circ\text{C}$
I_{DSS}	Zero Gate Voltage Drain Current	$V_{DS} = 20\text{ V}$, $V_{GS} = 0\text{ V}$ $T_J = 55\text{ }^\circ\text{C}$			1	μA
					10	μA
I_{GSS}	Gate - Body Leakage Current	$V_{GS} = 8\text{ V}$, $V_{DS} = 0\text{ V}$			100	nA
ON CHARACTERISTICS (Note)						
$\Delta V_{GS(th)}/\Delta T_J$	Gate Threshold Voltage Temp. Coefficient	$I_D = 250\text{ }\mu\text{A}$, Referenced to $25\text{ }^\circ\text{C}$		-2.6		mV / $^\circ\text{C}$
$V_{GS(th)}$	Gate Threshold Voltage	$V_{DS} = V_{GS}$, $I_D = 250\text{ }\mu\text{A}$	0.65	0.8	1	V
$R_{DS(on)}$	Static Drain-Source On-Resistance	$V_{GS} = 4.5\text{ V}$, $I_D = 0.5\text{ A}$ $T_J = 125\text{ }^\circ\text{C}$		0.33	0.45	Ω
					0.52	
		$V_{GS} = 2.7\text{ V}$, $I_D = 0.2\text{ A}$		0.44	0.6	
$I_{D(on)}$	On-State Drain Current	$V_{GS} = 2.7\text{ V}$, $V_{DS} = 5\text{ V}$	0.5			A
g_{FS}	Forward Transconductance	$V_{DS} = 5\text{ V}$, $I_D = 0.5\text{ A}$		1.45		S
DYNAMIC CHARACTERISTICS						
C_{iss}	Input Capacitance	$V_{DS} = 10\text{ V}$, $V_{GS} = 0\text{ V}$, $f = 1.0\text{ MHz}$		50		pF
C_{oss}	Output Capacitance			28		pF
C_{rss}	Reverse Transfer Capacitance			9		pF
SWITCHING CHARACTERISTICS (Note)						
$t_{D(on)}$	Turn - On Delay Time	$V_{DD} = 6\text{ V}$, $I_D = 0.5\text{ A}$, $V_{GS} = 4.5\text{ V}$, $R_{GEN} = 50\text{ }\Omega$		3	6	ns
t_r	Turn - On Rise Time			8.5	18	ns
$t_{D(off)}$	Turn - Off Delay Time			17	30	ns
t_f	Turn - Off Fall Time			13	25	ns
Q_g	Total Gate Charge	$V_{DS} = 5\text{ V}$, $I_D = 0.5\text{ A}$, $V_{GS} = 4.5\text{ V}$		1.64	2.3	nC
Q_{gs}	Gate-Source Charge			0.38		nC
Q_{gd}	Gate-Drain Charge			0.45		nC
DRAIN-SOURCE DIODE CHARACTERISTICS AND MAXIMUM RATINGS						
I_S	Maximum Continuous Drain-Source Diode Forward Current				0.3	A
V_{SD}	Drain-Source Diode Forward Voltage	$V_{GS} = 0\text{ V}$, $I_S = 0.5\text{ A}$ (Note)		0.83	1.2	V

Note:

Pulse Test: Pulse Width $\leq 300\mu\text{s}$, Duty Cycle $\leq 2.0\%$.

Typical Electrical Characteristics

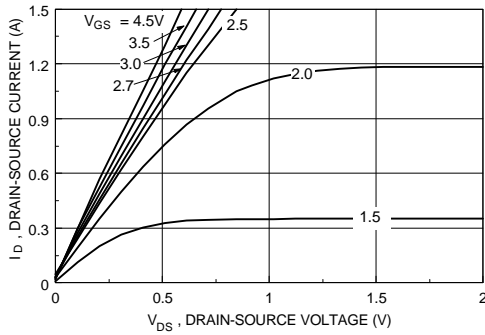

Figure 1. On-Region Characteristics.

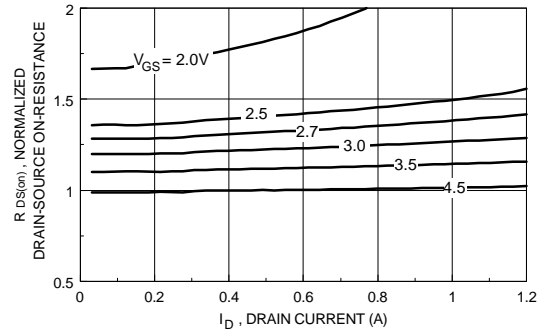

Figure 2. On-Resistance Variation with Drain Current and Gate Voltage.

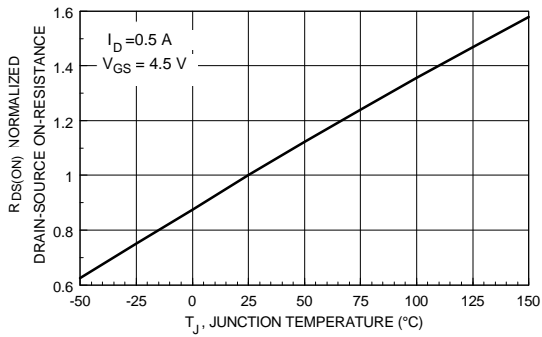

Figure 3. On-Resistance Variation with Temperature.

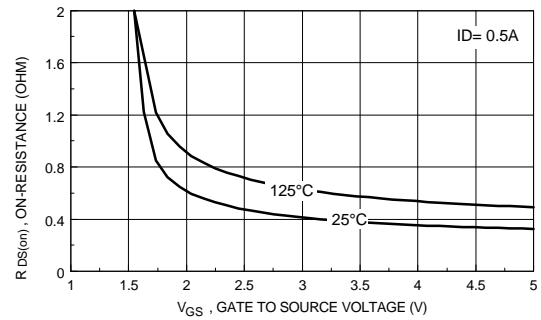

Figure 4. On Resistance Variation with Gate-To- Source Voltage.

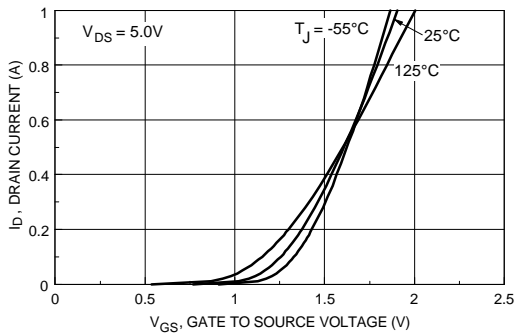

Figure 5. Transfer Characteristics.

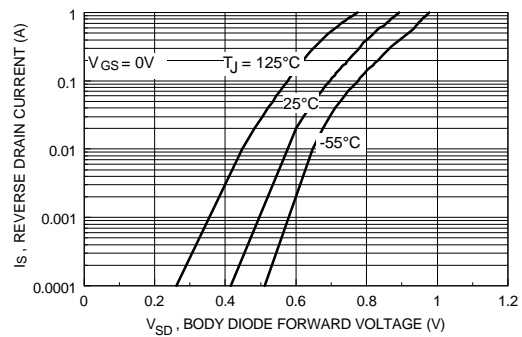

Figure 6. Body Diode Forward Voltage Variation with Source Current and Temperature.

Typical Electrical And Thermal Characteristics

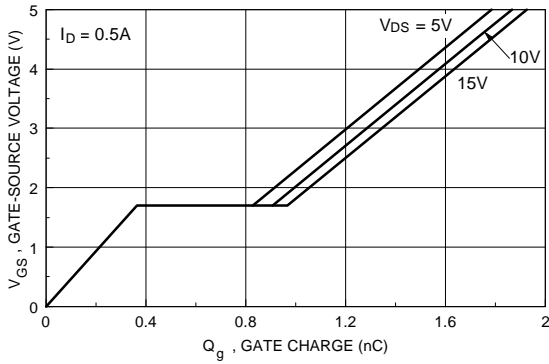

Figure 7. Gate Charge Characteristics.

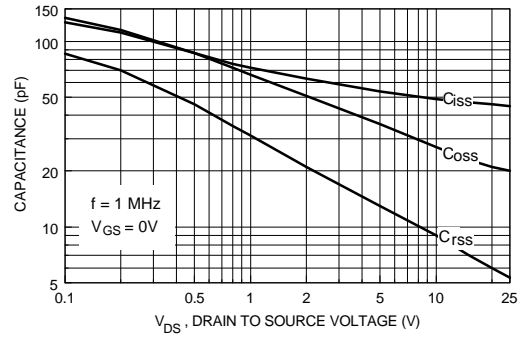

Figure 8. Capacitance Characteristics.

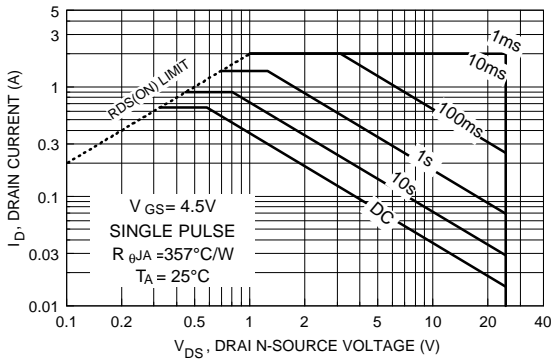

Figure 9. Maximum Safe Operating Area.

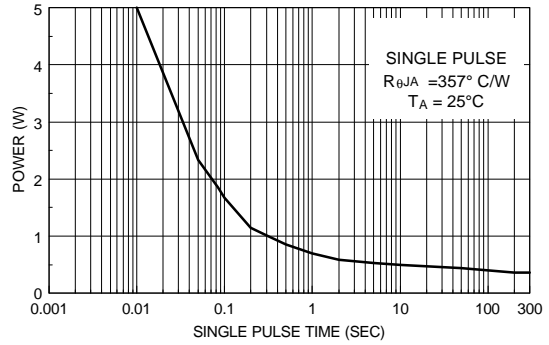

Figure 10. Single Pulse Maximum Power Dissipation.

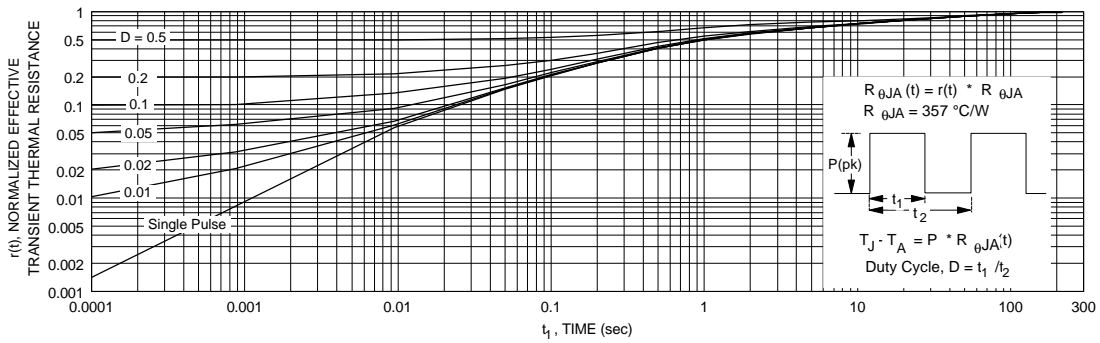
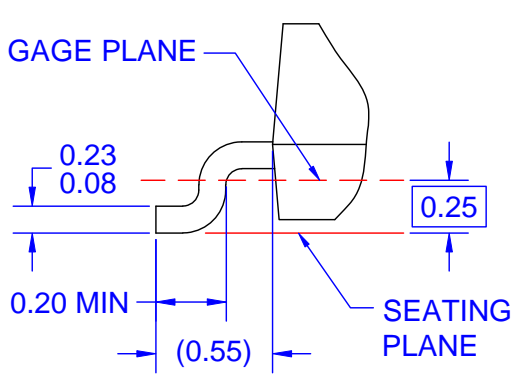
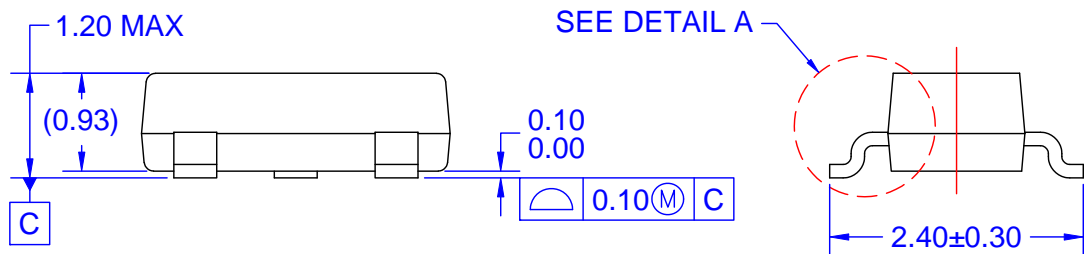

Figure 11. Transient Thermal Response Curve.







DETAIL A
 SCALE: 2X

- NOTES: UNLESS OTHERWISE SPECIFIED
- A) REFERENCE JEDEC REGISTRATION TO-236, VARIATION AB, ISSUE H.
 - B) ALL DIMENSIONS ARE IN MILLIMETERS.
 - C) DIMENSIONS ARE INCLUSIVE OF BURRS, MOLD FLASH AND TIE BAR EXTRUSIONS.
 - D) DIMENSIONING AND TOLERANCING PER ASME Y14.5M - 1994.
 - E) DRAWING FILE NAME: MA03DREV10



TRADEMARKS

The following includes registered and unregistered trademarks and service marks, owned by Fairchild Semiconductor and/or its global subsidiaries, and is not intended to be an exhaustive list of all such trademarks.

AccuPower™	F-PFS™		
Awinda®	FRFET®	PowerTrench®	TinyBoost®
AX-CAP®*	Global Power Resource SM	PowerXS™	TinyBuck®
BitSiC™	GreenBridge™	Programmable Active Droop™	TinyCalc™
Build it Now™	Green FPS™	QFET®	TinyLogic®
CorePLUS™	Green FPS™ e-Series™	QS™	TINYOPTO™
CorePOWER™	Gmax™	Quiet Series™	TinyPower™
CROSSVOLT™	GTO™	RapidConfigure™	TinyPWM™
CTL™	IntelliMAX™		TinyWire™
Current Transfer Logic™	ISOPLANAR™	Saving our world, 1mW/W/kW at a time™	TranSiC™
DEUXPEED®	Making Small Speakers Sound Louder and Better™	SignalWise™	TriFault Detect™
Dual Cool™	MegaBuck™	SmartMax™	TRUECURRENT®*
EcoSPARK®	MICROCOUPLER™	SMART START™	μSerDes™
EfficientMax™	MicroFET™	Solutions for Your Success™	
ESBC™	MicroPak™	SPM®	UHC®
	MicroPak2™	STEALTH™	Ultra FRFET™
Fairchild®	MillerDrive™	SuperFET®	UniFET™
Fairchild Semiconductor®	MotionMax™	SuperSOT™-3	VCX™
FACT Quiet Series™	MotionGrid®	SuperSOT™-6	VisualMax™
FACT®	MTi®	SuperSOT™-8	VoltagePlus™
FAST®	MTx®	SupreMOS®	XST™
FastvCore™	MTV®	SyncFET™	Xsens™
FETBench™	mWSaver®	Sync-Lock™	仙童™
FPS™	OptoHiT™		

* Trademarks of System General Corporation, used under license by Fairchild Semiconductor.

DISCLAIMER

FAIRCHILD SEMICONDUCTOR RESERVES THE RIGHT TO MAKE CHANGES WITHOUT FURTHER NOTICE TO ANY PRODUCTS HEREIN TO IMPROVE RELIABILITY, FUNCTION, OR DESIGN. FAIRCHILD DOES NOT ASSUME ANY LIABILITY ARISING OUT OF THE APPLICATION OR USE OF ANY PRODUCT OR CIRCUIT DESCRIBED HEREIN; NEITHER DOES IT CONVEY ANY LICENSE UNDER ITS PATENT RIGHTS, NOR THE RIGHTS OF OTHERS. THESE SPECIFICATIONS DO NOT EXPAND THE TERMS OF FAIRCHILD'S WORLDWIDE TERMS AND CONDITIONS, SPECIFICALLY THE WARRANTY THEREIN, WHICH COVERS THESE PRODUCTS.

LIFE SUPPORT POLICY

FAIRCHILD'S PRODUCTS ARE NOT AUTHORIZED FOR USE AS CRITICAL COMPONENTS IN LIFE SUPPORT DEVICES OR SYSTEMS WITHOUT THE EXPRESS WRITTEN APPROVAL OF FAIRCHILD SEMICONDUCTOR CORPORATION.

As used herein:

1. Life support devices or systems are devices or systems which, (a) are intended for surgical implant into the body or (b) support or sustain life, and (c) whose failure to perform when properly used in accordance with instructions for use provided in the labeling, can be reasonably expected to result in a significant injury of the user.
2. A critical component in any component of a life support, device, or system whose failure to perform can be reasonably expected to cause the failure of the life support device or system, or to affect its safety or effectiveness.

ANTI-COUNTERFEITING POLICY

Fairchild Semiconductor Corporation's Anti-Counterfeiting Policy. Fairchild's Anti-Counterfeiting Policy is also stated on our external website, www.fairchildsemi.com, under Sales Support.

Counterfeiting of semiconductor parts is a growing problem in the industry. All manufacturers of semiconductor products are experiencing counterfeiting of their parts. Customers who inadvertently purchase counterfeit parts experience many problems such as loss of brand reputation, substandard performance, failed applications, and increased cost of production and manufacturing delays. Fairchild is taking strong measures to protect ourselves and our customers from the proliferation of counterfeit parts. Fairchild strongly encourages customers to purchase Fairchild parts either directly from Fairchild or from Authorized Fairchild Distributors who are listed by country on our web page cited above. Products customers buy either from Fairchild directly or from Authorized Fairchild Distributors are genuine parts, have full traceability, meet Fairchild's quality standards for handling and storage and provide access to Fairchild's full range of up-to-date technical and product information. Fairchild and our Authorized Distributors will stand behind all warranties and will appropriately address any warranty issues that may arise. Fairchild will not provide any warranty coverage or other assistance for parts bought from Unauthorized Sources. Fairchild is committed to combat this global problem and encourage our customers to do their part in stopping this practice by buying direct or from authorized distributors.

PRODUCT STATUS DEFINITIONS

Definition of Terms

Datasheet Identification	Product Status	Definition
Advance Information	Formative / In Design	Datasheet contains the design specifications for product development. Specifications may change in any manner without notice.
Preliminary	First Production	Datasheet contains preliminary data; supplementary data will be published at a later date. Fairchild Semiconductor reserves the right to make changes at any time without notice to improve design.
No Identification Needed	Full Production	Datasheet contains final specifications. Fairchild Semiconductor reserves the right to make changes at any time without notice to improve the design.
Obsolete	Not In Production	Datasheet contains specifications on a product that is discontinued by Fairchild Semiconductor. The datasheet is for reference information only.

Rev. I70