

General purpose sensors in compact plastic housing

E3Z

- Compact housing size and high power LED for excellent performance-size ratio
- IP67 and IP69k for highest protection in wet environments

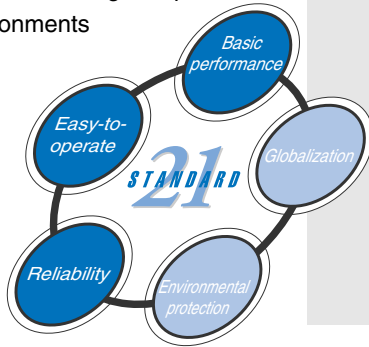

Features

Basic performance

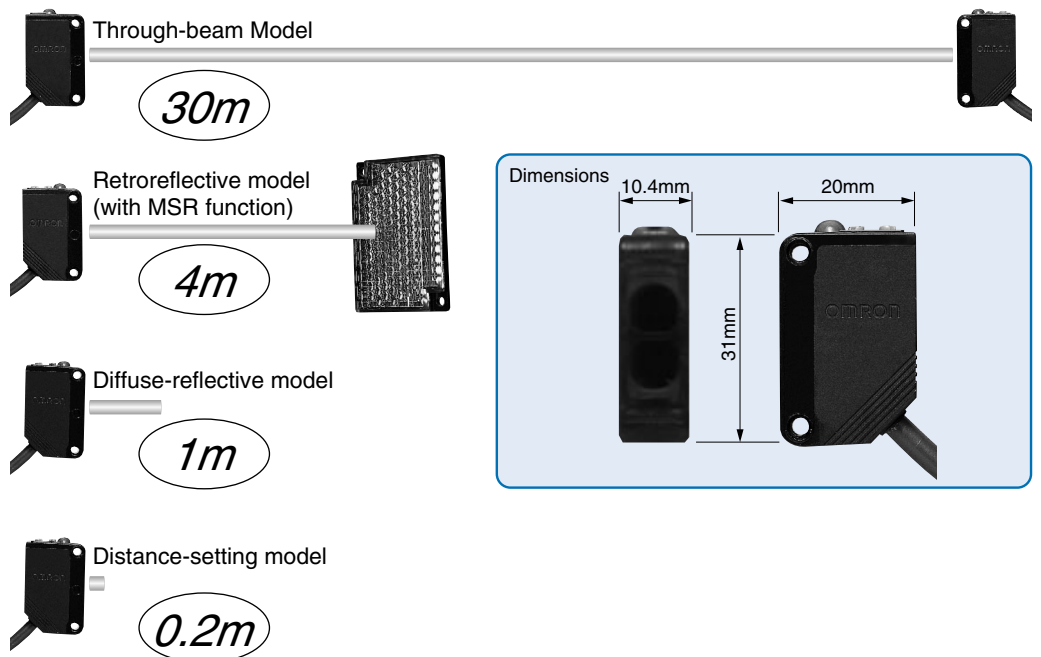

Reliability

Eliminates the influence of installation and on-site conditions, thus increasing the reliability of the line.

High protection against water and dust contaminants



High immunity to electrical interference, such as inverter drives.

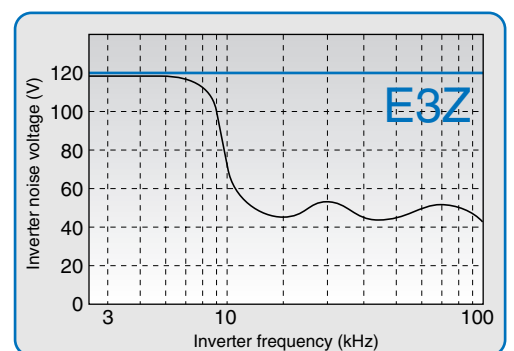

Stability

E3Z-series reliability covers a wide range of object/background combinations, so ensuring stable detection regardless of workpiece color or reflectivity.

Foreground Suppression & Background Suppression

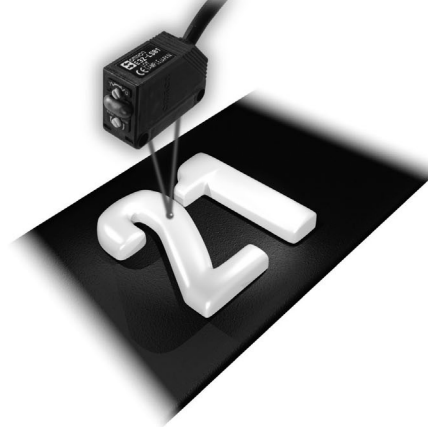

Environmental protection

Photoelectric Sensor with Built-in Amplifier



E3Z is environmental-friendly, energy-saving.

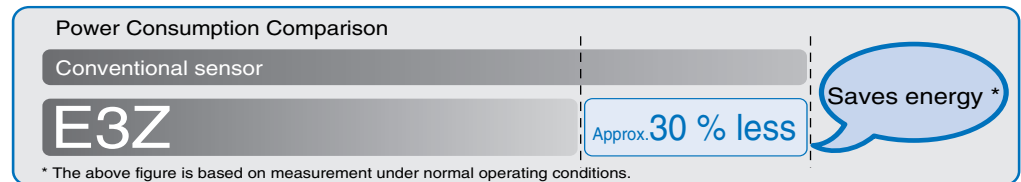

10-quantity packing reduces waste cartons.

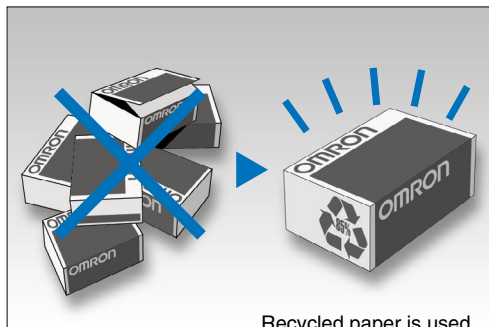

Recycled paper is used.

Standard models provided with a 0.5-m cable are available for the elimination of unnecessary cable length.

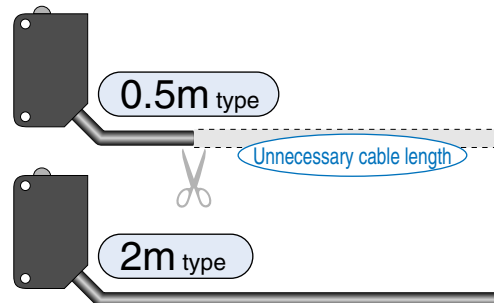

Packed in "combustible" polyethylene bags free of Styrofoam. *



* If this bag is burned, dioxins hazardous to humans are minimal.

On-going elimination of materials containing lead.

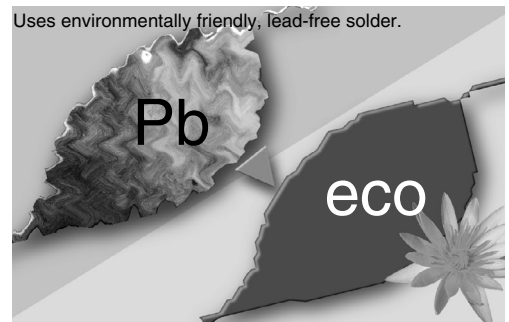

Uses environmentally friendly, lead-free solder.

Narrow Beam model

Ideal for detecting small objects with a small spot:

- Tiny objects as little as 0.1 mm in diameter can be detected with its 2.5-mm dia. spot.
- The thin beam enables detection through gaps or small holes.
- The high-intensity spot of light enables visual alignment of sensing spot position.



Transparent PET bottles

Stable detection of recyclable thin-wall PET bottles.

Standard-size transparent object sensor

- Uses OMRON's unique optical system ("Inner View") that can detect various shapes of PET bottles and transparent objects.
- Detects a wide range of bottles regardless of size and facets



Fork Sensor, single and dual beam versions

Fork design eliminates the need for optical axis adjustment.

- Two-axis models also available.
- Ideal for limit of travel monitoring.
- Condition monitoring.
- „Flag“ identification.

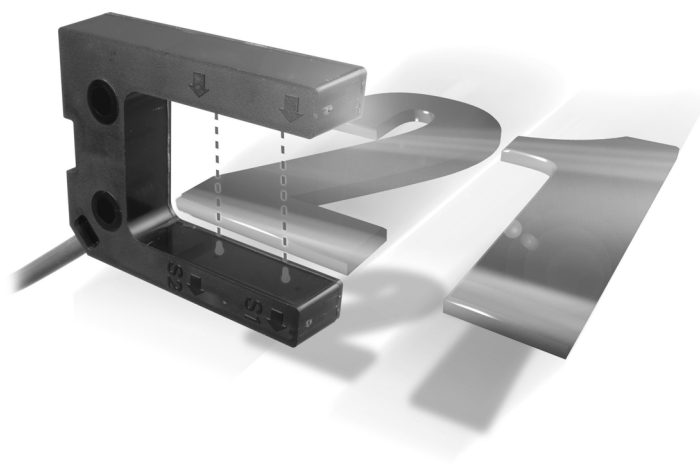

Applications

E3Z-LS background and foreground suppression models

Detecting covers on cosmetic products



Detecting pastries on conveyor belts

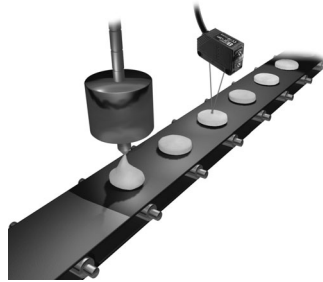

Detecting packaged chewing gum or candy

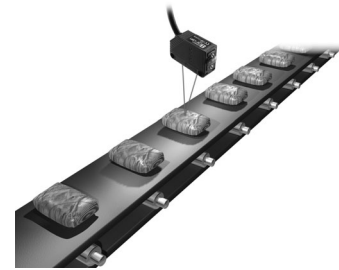

E3Z-L narrow beam models

Checking for straws

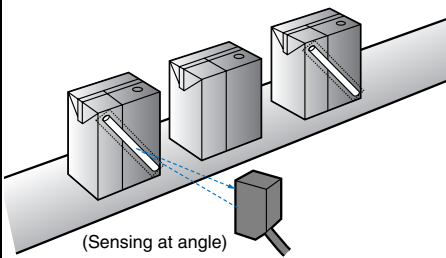

Determining front/back or orientation of floppy disks

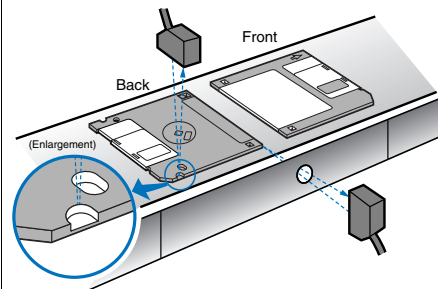

Detecting uneven joints

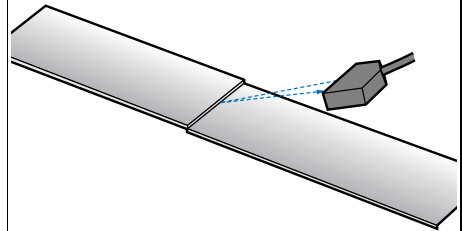

E3Z-B transparent object model

Transparent PET Bottle-related Detection - One bottle

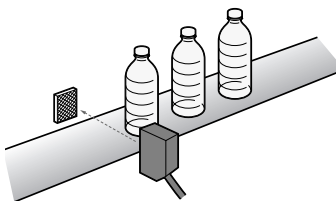

Transparent PET Bottle related Detection - Multiple bottles (Stocker)

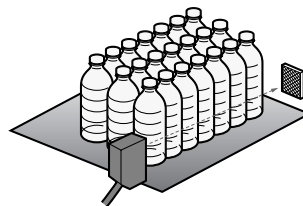

Detection of films and glass plates

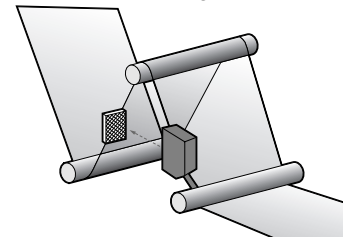

E3Z-G grooved type model

Crane and automated warehouse conveyor table passage inspection and positioning.

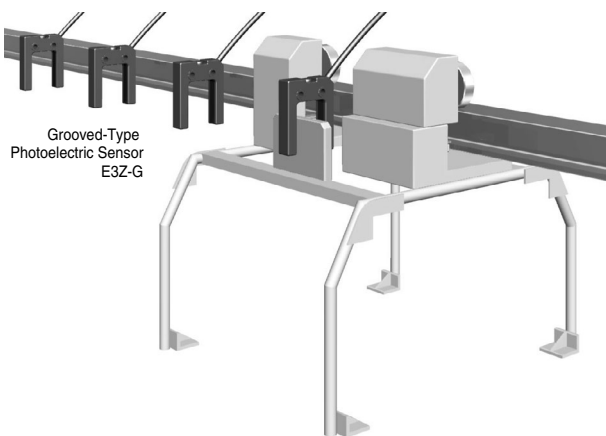

Ordering Information

Sensors

Red light Infrared light

Sensor type	Shape	Connection method	Sensing distance	Model						
				NPN output	PNP output					
Through-beam		Pre-wired models (2 m)*1		30m	E3Z-T62	E3Z-T82				
		Connector type			E3Z-T62-G0*2	E3Z-T82-G0				
		Pre-wired models (2 m)*1		15m	E3Z-T67	E3Z-T87				
		Connector type			E3Z-T67-G0	E3Z-T87-G0				
		Pre-wired models (2 m)*1		10m	E3Z-T61	E3Z-T81				
		Connector type			E3Z-T66	E3Z-T86				
		Pre-wired models (2 m)*1		10m	E3Z-T61A	E3Z-T81A				
		Connector type			E3Z-T66A	E3Z-T86A				
Retroreflective model (with M.S.R. function)		Pre-wired (2 m)*1		4m [100mm]	*4	E3Z-R61	E3Z-R81			
		Connector type				E3Z-R66	E3Z-R86			
Diffuse-reflective		Pre-wired models (2 m)*1		5 to 100 mm (wide view)		E3Z-D61	E3Z-D81			
		Connector type				E3Z-D66	E3Z-D86			
		Pre-wired models (2 m)*1, *5		1m		E3Z-D62	E3Z-D82			
		Connector type				E3Z-D67	E3Z-D87			
Thin beam type reflective model		Pre-wired models (2 m)*1		90±30mm		E3Z-L61	E3Z-L81			
		Connector type				E3Z-L66	E3Z-L86			
Distance-settable		Pre-wired models (2 m)*1				E3Z-LS61	E3Z-LS81			
		Connector type				E3Z-LS66	E3Z-LS86			
Transparent PET bottle type Retro-reflective model (without M.S.R. function)		Pre-wired (2 m)*1					500mm [80mm]	*4	E3Z-B61	E3Z-B81
		Connector type							E3Z-B66	E3Z-B86
		Pre-wired models (2 m)*1		2m [100mm]	*4	E3Z-B62	E3Z-B82			
		Connector type				E3Z-B67	E3Z-B87			
Grooved type through-beam model		1		25mm		E3Z-G61	E3Z-G81			
		2				E3Z-G62	E3Z-G82			
		1				E3Z-G61-M3J	E3Z-G81-M3J			
		2				E3Z-G62-M3J	E3Z-G82-M3J			

- *1. Models provided with a 0.5-m cable are available. When ordering, specify the cable length by adding the code "0.5M" to the model number (e.g., E3Z-T61 0.5M).
- *2. With „Emission Stop“ feature. Can be used to force a state change at the receiver (Sensor function test).
- *3. Not attached. Please purchase the optional reflector (9 types) according to your application.
- *4. The sensing distance specified is possible when the E39-R1S used. Figure in parentheses indicate the minimum required distance between the Sensor and Reflector.
- *5. The connector joint type is available M12. Its model ends with -M1. (Example: E3Z-T61-M1J)

Accessories (Order Separately)

Slits

Slit width	Sensing distance (typical)		Minimum sensing object (typical)	Model	Quantity
	E3Z-T□□	E3Z-T□□A			
0.5 mm dia.	50 mm	35 mm	0.2 mm dia.	E39-S65A	One set (contains slits for both the emitter and receiver)
1-mm dia.	200 mm	150 mm	0.4 mm dia.	E39-S65B	
2-mm dia.	800 mm	550 mm	0.7 mm dia.	E39-S65C	
0.5 x 10 mm	1 m	700 mm	0.2 mm dia.	E39-S65D	
1 x 10 mm	2.2 m	1.5 m	0.5 mm dia.	E39-S65E	
2 x 10 mm	5 m	3.5 m	0.8 mm dia.	E39-S65F	

Reflectors

Not provided with retroreflective models

Name	Sensing distance (typical) *	Model	Quantity	Remarks
Reflectors	3 m [100 mm] (Rated value)	E39-R1	1	for E3Z-B□1/6 for E3Z-B□2/7
	4 m [100 mm] (Rated value)	E39-R1S	1	
	500 mm [80 mm]	E39-R1S	1	
	2 m [100 mm]			
	5 m [100 mm]	E39-R2	1	
	2.5 m [100 mm]	E39-R9	1	
3.5 m [100 mm]	E39-R10	1		
Fog preventing	500 mm [80 mm]	E39-R1K	1	for E3Z-B□1/6 for E3Z-B□2/7
	2 m [100 mm]			
Small reflector	1.5 m [50 mm]	E39-R3	1	
Tape Reflector	700 mm [150 mm]	E39-RS1	1	
	1.1 m [150 mm]	E39-RS2	1	
	1.4 m [150 mm]	E39-RS3	1	

* Values in parentheses indicate the minimum required distance between the sensor and reflector.

Note: 1. When using the reflector of other than the rated value, set the sensing distance to about 0.7 times of the typical example as a guideline.

2. For details, refer to the "Reflector list".

Mutual interference prevention filter

Sensing distance	Shape/dimensions	Model	Quantity	Remarks
3 m		E39-E11	2 sets each for emitters and receivers (total of 4 pcs.)	Can be used with the through-beam E3Z-T□□A. The arrow represents the polarizing direction. Changing the polarizing direction of the two adjacent emitters and receivers prevents mutual interference.





Mounting Brackets

Shape	Model	Quantity	Remarks	Shape	Model	Quantity	Remarks
	E39-L153	1	Mounting Brackets		E39-L150	One set	Sensor adjuster Easy mounting to aluminum frame/rail of conveyor or like, easy adjustment. For left-to-right adjustment
	E39-L104	1					
	9-L43	1	Horizontal type mounting bracket		E39-L151	One set	
	E39-L142	1	Horizontal type protective cover bracket		E39-L93□	One set	Sensor adjuster Easy mounting to aluminum frame/rail of conveyor or like, easy adjustment. For vertical angle adjustment
	E39-L44	1	Rear mounting bracket				
	E39-L98	1	Protective cover bracket		E39-L144	1	Vertical protective cover bracket

Note: 1. If a through-beam model is used, order two Mounting Brackets for the emitter and receiver respectively.

2. For details, refer to the "Mounting bracket list".

Sensor I/O Connectors

Size	Cable type	Shape	Cable length		Model	
M8	Standard cable	Straight 	2 m	4-wire type	XS3F-M421-402-A	
			5 m		XS3F-M421-405-A	
		L-shaped 	2 m		XS3F-M422-402-A	
			5 m		XS3F-M422-405-A	
M12 (for -M1J)		Standard cable	Straight 	2 m	3-wire type	XS2F-D421-DC0-A
				5 m		XS2F-D421-GC0-A
			L-shaped 	2 m		XS2F-D422-DC0-A
				5 m		XS2F-D422-GC0-A

Rating/performance

Sensor type		Through-beam			Retroreflective model (with M.S.R. function)	Diffuse-reflective		
						wide-beam	standard-beam	
Item	Model	NPN output	E3Z-T62/T67	E3Z-T61/T66	E3Z-T61A/T66A	E3Z-R61/R66	E3Z-D61/D66	E3Z-D62/D67
		PNP output	E3Z-T82/T87	E3Z-T81/T86	E3Z-T81A/T86A	E3Z-R81/R86	E3Z-D81/D86	E3Z-D82/D87
Sensing distance		30 m	15 m	10 m	4 m (100 mm) * (When using the E39-R1S) 3 m (100 mm) * (When using the E39-R1)	100 mm (White paper 100 x 100 mm)	1 m (White paper 300 x 300 mm)	
Setting range		---						
Reflectivity characteristic		---						
Spot Diameter		---						
Standard sensing object		Opaque: 12-mm dia. min.			Opaque: 75-mm dia. min.		---	
Min. sensing object		---						
Differential distance		---				20% max. of sensing distance		
Directional angle		Both emitter and receiver: 3° to 15°		Both emitter and receiver: 3° to 5°	2° to 10°	---		
Light source (wave length)		Infrared LED (870 nm)	Infrared LED (860 nm)	Red LED (700 nm)	Red LED (680 nm)	Infrared LED (860 nm)		
Power supply voltage		12 to 24 VDC ±10%, ripple (p-p) : 10% max.						
Current consumption		emitter: 15 mA receiver: 20 mA			30 mA max.			
Control output		Load power supply voltage 26.4 VDC max., load current 100 mA max. (residual voltage 2 V max.) Open collector output type (depends on the NPN/PNP output format) Light-ON/Dark-ON switch selectable						
BGS / FGS selection		---						
Protective circuits		Reverse polarity protection, output short-circuit protection, mutual interference prevention, output reverse protection	Protection from load short-circuit and reversed power supply connection		Reverse polarity protection, output short-circuit protection, mutual interference prevention, output reverse protection			
Response time		Operation or reset: 2 ms max.	Operation or reset: 1 ms max.					
Sensitivity adjustment		Single-turn adjustment						
Ambient illuminance		Incandescent lamp: 3,000 lux max. Sunlight 10,000 lux max.						
Ambient temperature		Operating: -25°C to 55°C, Storage: -40°C to 70°C (with no icing or condensation)						
Ambient humidity		Operating: 35% to 85% RH, Storage: 35% to 95% RH (with no icing or condensation)						
Insulation resistance		20 MΩ min. at 500 VDC						
Dielectric strength		1,000 VAC at 50/60 Hz for 1 minute						

* Values in parentheses indicate the minimum required distance between the sensor and reflector.

Rating/performance

Diffuse-reflective narrow-beam	Distance-settable	Retro-reflective for PET bottles (without MSR function)		Grooved-type	
		standard-beam	wide-beam		
E3Z-L61/66	E3Z-LS61/66	E3Z-B61/66	E3Z-B62/67	E3Z-G61	E3Z-G62
E3Z-L81/86	E3Z-LS81/86	E3Z-B81/86	E3Z-B82/87	E3Z-G81	E3Z-G82
90 ± 30 mm (White paper 100 x 100 mm)	BGS: White or black paper (100 x 100 mm): 20 mm to set distance FGS: White paper (100 x 100 mm): Set distance to 200 mm min. Black paper (100 x 100 mm): Set distance to 160 mm min.	500 mm (80 mm) * (When using the E39-R1S)	2 m (100 mm) * (When using the E39-R1S)	25 mm 1 optical axis 2 optical axis	
---	White paper (100 x 100 mm): 40 to 200 mm Black paper (100 x 100 mm): 40 to 160 mm	---			
Refer to the diagram „Hysteresis Difference vs. Sensing Distance“	Black/white-error: 10% of set distance max.	---			
2.5 mm dia. (when sensing distance is 90 mm)	---				
---	Transparent round PET bottle 500 ml (65 mm dia.)		---		
0.1 mm dia. (copper wire)					

Red LED (650 nm)	Red LED (680 nm)	Red LED (660 nm)		Infrared LED (860 nm)	
12 to 24 VDC ±10%, ripple (p-p) : 10% max.					
30 mA max				25 mA max.	40 mA max.
Load power supply voltage 26.4 VDC max., load current 100 mA max. (residual voltage 2 V max.) Open collector output type (depends on the NPN/PNP output format) Light-ON/Dark-ON switch selectable					
---	BGS: Open or connected to GND FGS: Connected to Vcc	---			
Reverse polarity protection, output short-circuit protection, mutual interference prevention					
Operation or reset: 1 ms max.					
Single-turn adjustment	five-turn endless adjuster	Single-turn adjustment		---	
Incandescent lamp: 3,000 lux max. Sunlight 10,000 lux max.					
Operating: -25°C to 55°C, Storage: -40°C to 70°C (with no icing or condensation)					
Operating: 35% to 85% RH, Storage: 35% to 95% RH (with no icing or condensation)					
20 M min. at 500 VDC					
1,000 VAC at 50/60 Hz for 1 minute					

Rating/performance

Sensor type		Through-beam			Retroreflective model (with M.S.R. function)	Diffuse-reflective		
						wide-beam	standard-beam	
Item	Model	NPN output	E3Z-T62/T67	E3Z-T61/T66	E3Z-T61A/T66A	E3Z-R61/R66	E3Z-D61/D66	E3Z-D62/D67
		PNP output	E3Z-T82/T87	E3Z-T81/T86	E3Z-T81A/T86A	E3Z-R81/R86	E3Z-D81/D86	E3Z-D82/D87
Vibration resistance		10 to 55 Hz, 1.5-mm or 300m/s ² double amplitude for 2 hours each in X, Y, and Z directions						
Shock resistance		Destruction: 500 m/s ² for 3 times each in X, Y, and Z directions						
Protective structure		IEC 60529 IP67, IP69k after DIN 40050 part 9						
Connection method		Pre-wired (standard length: 2 m/500 mm)/M8 connector						
Indicator lamp		Operation indicator (orange), stability indicator (green) [Note that the emitter has the power indicator (orange) only]						
Weight (Packed state)	Pre-wired models (with 2-m cable)	Approx. 120 g			65 g			
	Connector type	30 g			Approx. 20 g			
Material	Case	PBT (polybutylene terephthalate)						
	Lens	Denatured polyacrylate resin	Methacrylate resin					
Accessories		Instruction manual (The Reflector or Mounting Bracket is not provided with any of the above models.)						

Rating/performance

Diffuse-reflective narrow-beam	Distance-settable	Retro-reflective for PET bottles (without MSR function)		Grooved-type	
		standard-beam	wide-beam		
E3Z-L61/66	E3Z-LS61/66	E3Z-B61/66	E3Z-B62/67	E3Z-G61	E3Z-G62
E3Z-L81/86	E3Z-LS81/86	E3Z-B81/86	E3Z-B82/87	E3Z-G81	E3Z-G82
10 to 55 Hz, 1.5-mm double amplitude for 2 hours each in X, Y, and Z directions					
Destruction: 500 m/s ² for 3 times each in X, Y, and Z directions					
IEC 60529 IP67				IEC 60529 IP64	
Pre-wired (standard length: 2 m/500 mm)/M8 connector				Pull-out cable type (standard cable length: 2 m/500 mm) / connector relay type (standard cable length: 300 mm)	
Operation indicator (orange), stability indicator (green)				Operation indicator (orange)	
Approx. 65 g		65 g			
Approx. 20 g				30 g	
PBT (polybutylene terephthalate)				ABS	
Methacrylate resin	Denaturated polyallylate		Methacrylate resin		
Instruction manual (The Reflector or Mounting Bracket is not provided with any of the above models.)					

Characteristic data (typical)

Operating Range

Narrow-beam

E3Z-L

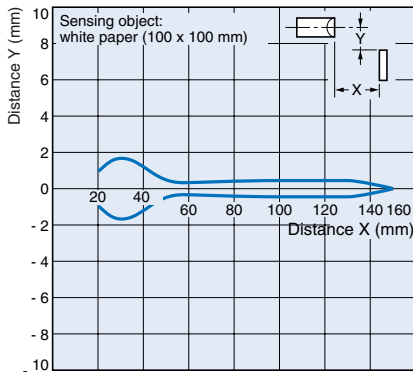

Distance-setting

E3Z-LS [BGS]

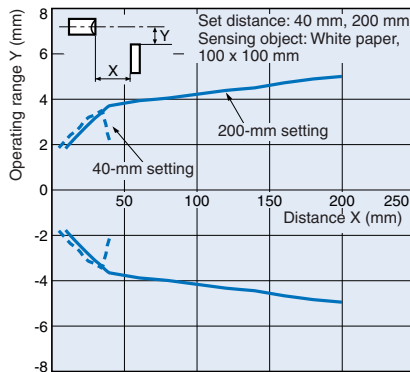

Retroreflective Models for transparent objects

E3Z-B□1/B□6 + E39-R1S (optional reflector)

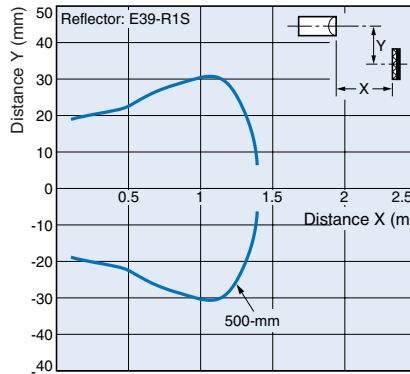

E3Z-B□2/B□7 + E39-R1S (optional reflector)

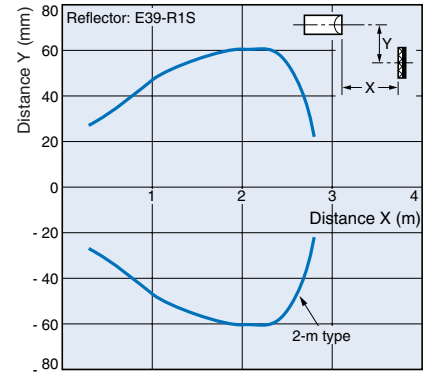

E3Z-LS [FGS]

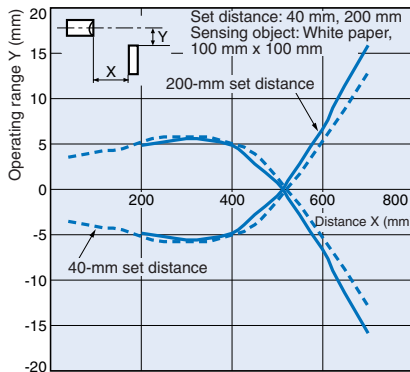

Excess Gain vs. Distance

Through-beam

E3Z-T□1(T□6)

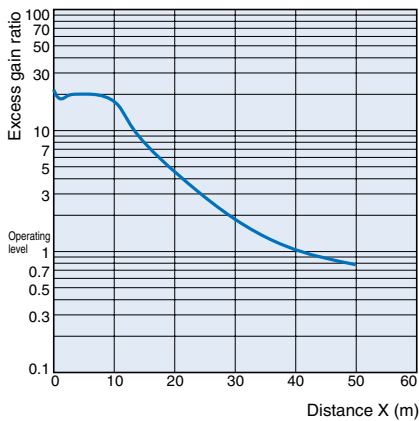

Through-beam

E3Z-T□A

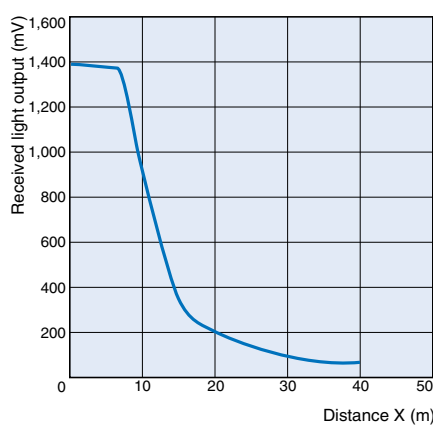

Retroreflective Models

E3Z-R□1(R□6) + Reflectors

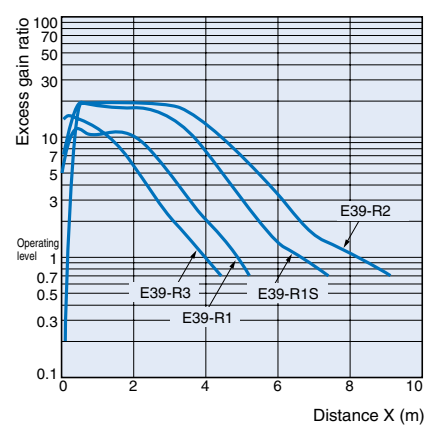

Diffuse-reflective
E3Z-D□1(D□6)

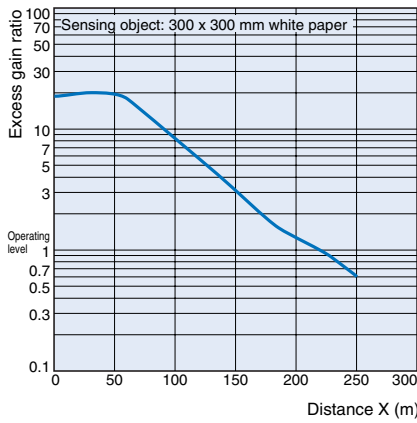

Diffuse-reflective
E3Z-D□2(D□7)

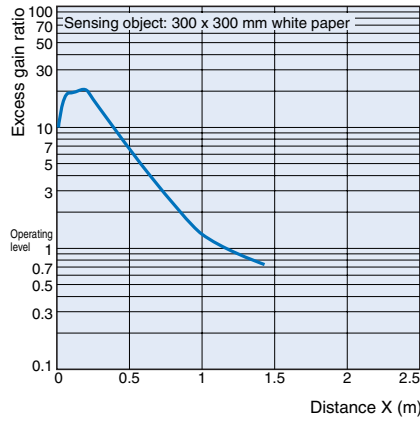

Narrow-beam
E3Z-L

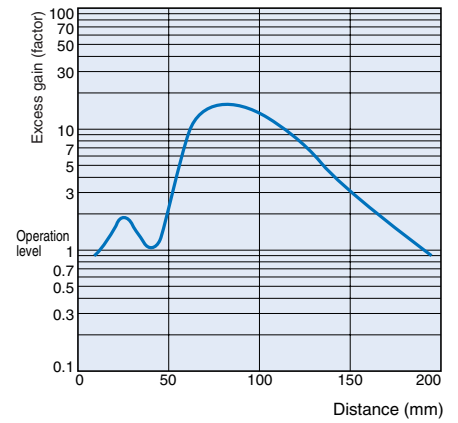

Retro-reflective for transparent objects
E3Z-B□1/B□6 + E39-R1S
(optional reflector)

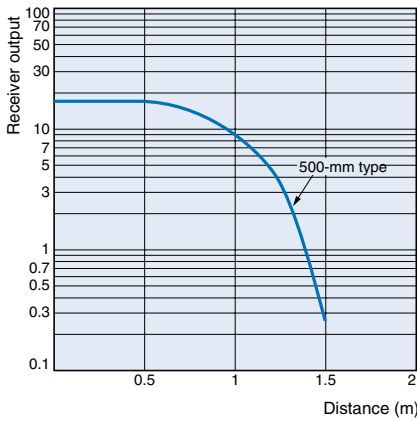

Retro-reflective for transparent objects
E3Z-B□2/B□7 + E39-R1S
(optional reflector)

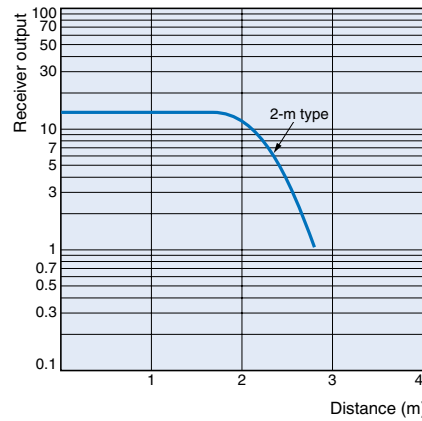

Distance vs. Size

Diffuse-reflective
E3Z-D□1(D□6)

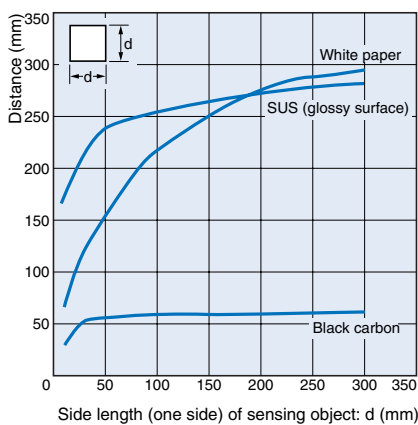

Diffuse-reflective
E3Z-D□2(D□7)

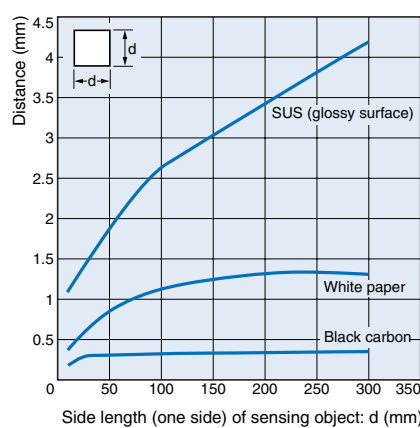

Narrow-beam
E3Z-L

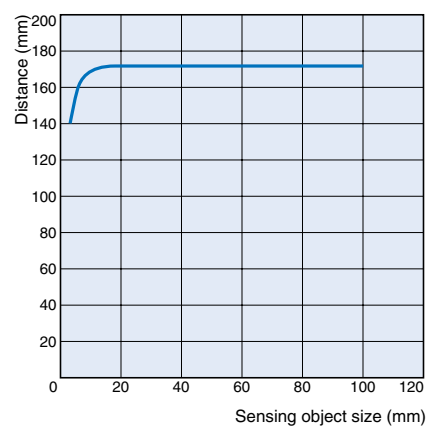

Spot diameter vs. Distance

Narrow-beam

E3Z-L

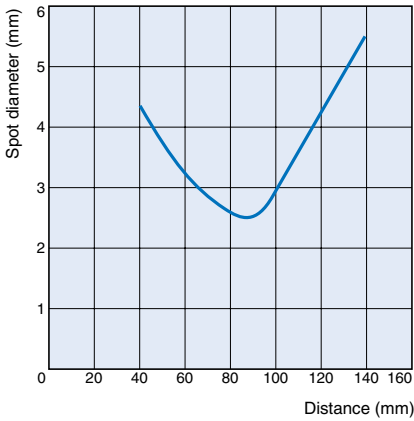

Distance setting

E3Z-LS

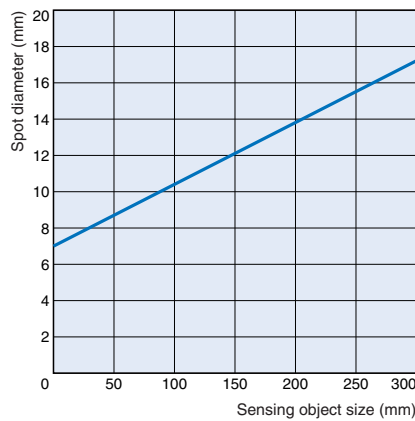

Differential travel / Hysteresis vs. Distance

Narrow-beam

E3Z-L

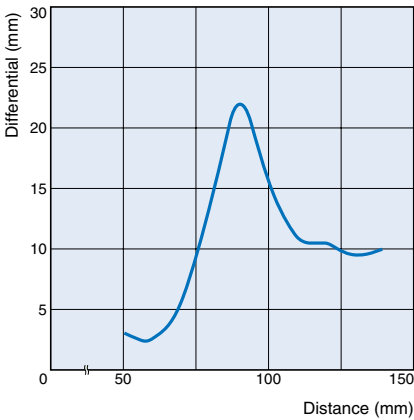

Distance setting

E3Z-LS

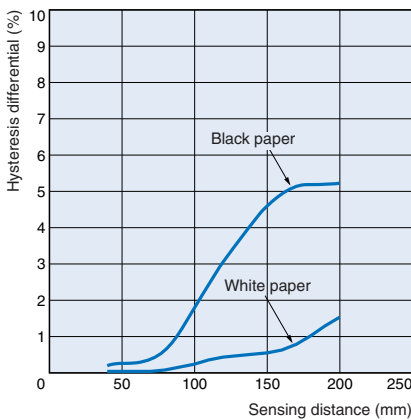

Inclination Characteristics

Distance setting

E3Z-LS

Vertical

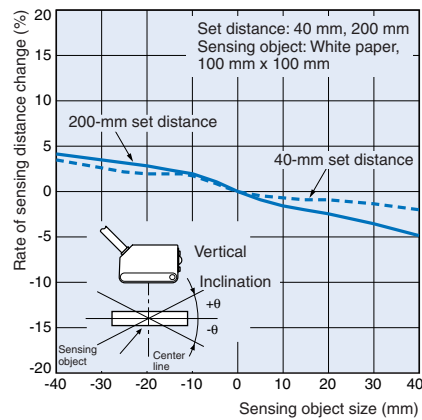

Horizontal

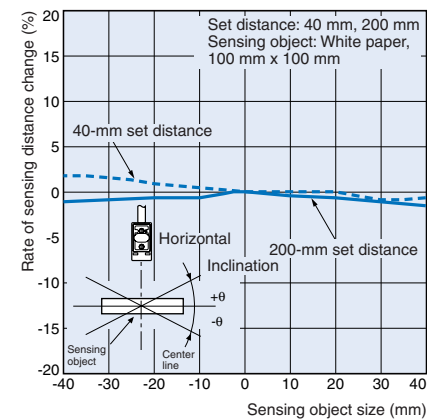

Short-distance Characteristics

Distance setting

E3Z-LS

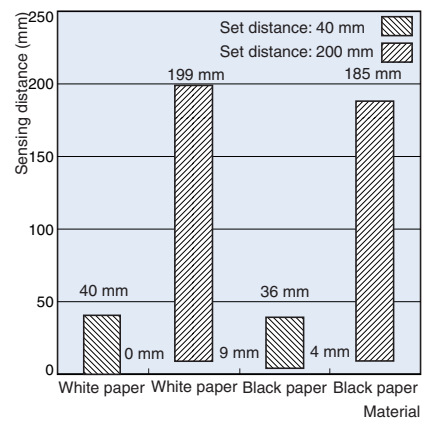

FGS Mode Set Distance vs. Sensing Range

Distance setting

E3Z-LS

White Paper

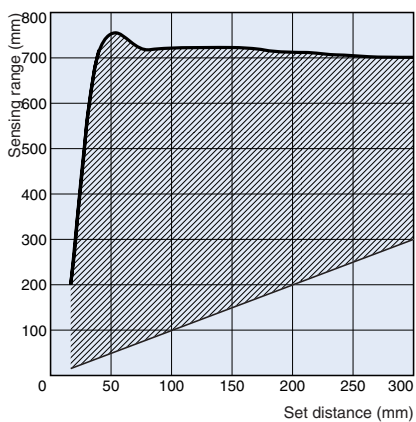

Black Paper

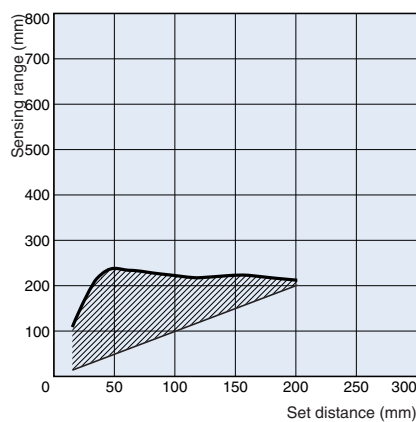

Sensing Distance vs. Material

Distance setting

E3Z-LS

At Set Distance of 40 mm

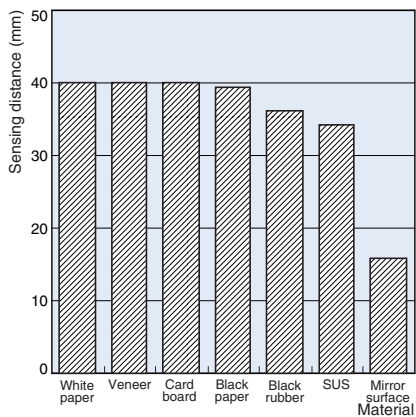

At Set Distance of 200 mm

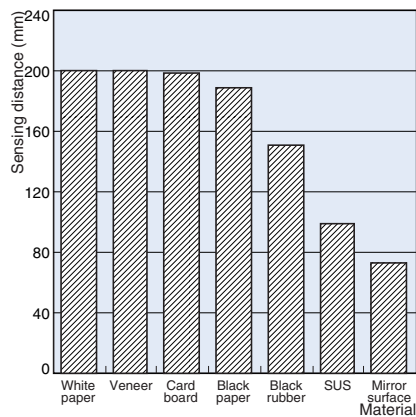

Output Circuit Diagram

NPN output

Model	Output transistor Status	Timing chart	Mode selection switch	Output circuit
E3Z-T61 E3Z-T66 E3Z-T61A E3Z-T66A E3Z-R61 E3Z-R66 E3Z-D61 E3Z-D66 E3Z-D62 E3Z-D67 E3Z-L61 E3Z-L66 E3Z-B61 E3Z-B62 E3Z-B66 E3Z-B67 E3Z-G61	Light ON		L ON (LIGHT ON)	<p>Through-beam receiver Retroreflective model Diffuse-reflective model</p>
	Dark ON		D ON (DARK ON)	<p>Connector Pin Arrangement</p> <p>Note: Terminal 2 is not used.</p>
E3Z-LS61 E3Z-LS66	Light ON		L ON (LIGHT ON)	<p>Through-beam emitter</p>
	Dark ON		D ON (DARK ON)	
Light ON		L ON (LIGHT ON)	<p>Connector Pin Arrangement</p> <p>BGS: Either leave the pink wire (2) open or connect it to the blue wire (3). FGS: Connect the pink wire (2) to the brown wire (1).</p>	
Dark ON		D ON (DARK ON)		
E3Z-G62	Light ON		L ON (LIGHT ON)	<p>Connector Pin arrangement</p>
	Dark ON		D ON (DARK ON)	

PNP output

Model	Output transistor Status	Timing chart	Mode selection switch	Output circuit
E3Z-T81 E3Z-T86 E3Z-T81A E3Z-T86A E3Z-R81 E3Z-R86 E3Z-D81 E3Z-D86 E3Z-D82 E3Z-D87 E3Z-L81 E3Z-L86 E3Z-B81 E3Z-B82 E3Z-B86 E3Z-B87 E3Z-G81	Light ON		L ON (LIGHT ON)	<p>Through-beam receiver Retroreflective model Diffuse-reflective model</p>
	Dark ON		D ON (DARK ON)	<p>Connector Pin Arrangement</p> <p>Note: Terminal 2 is not used.</p>
	Through-beam emitter			<p>Connector Pin Arrangement</p> <p>Note: Terminal 2 and 4 are not used.</p>
E3Z-LS81 E3Z-LS86	Light ON		L ON (LIGHT ON)	<p>Connector Pin Arrangement</p> <p>BGS: Either leave the pink wire (2) open or connect it to the blue wire (3). FGS: Connect the pink wire (2) to the brown wire (1).</p>
	Dark ON		D ON (DARK ON)	
	Light ON		L ON (LIGHT ON)	
	Dark ON		D ON (DARK ON)	
E3Z-G82	Light ON		L ON (LIGHT ON)	<p>Connector Pin arrangement</p>
	Dark ON		D ON (DARK ON)	

Connectors (Sensor I/O connectors)

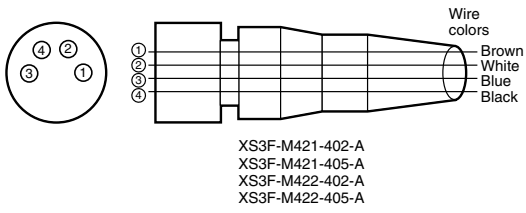

Class	Wire, outer jacket color	Connector pin No.	Application		
			Standard	E3Z-LS	E3Z-G62/82
For DC	Brown	①	Power supply (+V)		
	White	②	---	BGS / FGS selection	Output 2 (S2)
	Blue	③	Power supply (0 V)		
	Black	④	Output	Output 1 (S1)	

Nomenclature:

Through-beam

E3Z-T□□ Receiver
E3Z-T□□A Receiver

Retroreflective Models

E3Z-R□□
E3Z-B□□

Diffuse-reflective

E3Z-D□□
E3Z-L□□

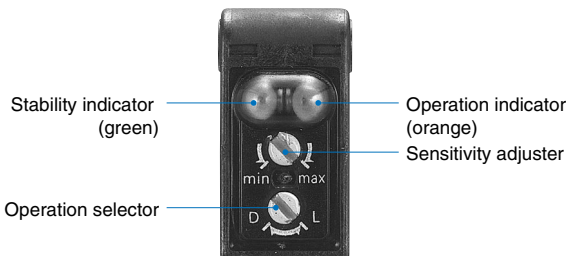

Distance-setting

E3Z-LS□□

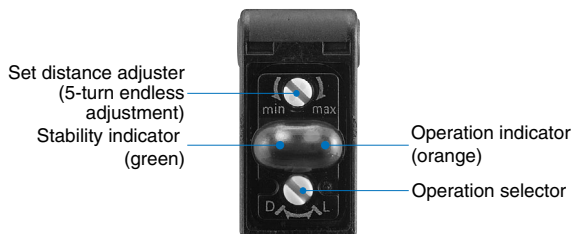

Operation

Slit for through-beam model (Optional accessory: E39-S65A/B/C/D/E/F)

Mounting method

- Hook the upper protruding portions of the Slit to the upper indented mounting portion of the Sensor and adjust the position of the Slit so that the Slit will be parallel to the lens surface.
- Press the lower protruding portion of the Slit onto the indented mounting portion of the Sensor until the Slit snaps in.

Mounting condition

Side view Front view

Demounting method

- Press the upper portion of the Slit.
- Disconnect the lower protruding portion of the Slit from the Sensor and remove the Slit.

BGS / FGS Application for distance setting E3Z-LS

Simple Detection of Glossy, Uneven Objects

BGS (Background Suppression)

(for Light-ON setting)

Objects beyond the set distance, such as the conveyor, will not be detected. The hysteresis is 10% or less, so at a set distance of 40 mm, steps with a thickness of 4 mm can be detected on objects.

ON (incident)
Distance threshold
OFF (interrupted)
Conveyor (background)

Selectable by Changing Cable Connection

FGS (Foreground Suppression)

(for Dark-ON setting)

Glossy, uneven objects are reliably detected because the OFF (incident) status occurs only when the conveyor is detected, and ON (interrupted) status occurs only when an object exists or when reflected light is not returned to the Sensor. (Depending on the shape of the object, an OFF-delay timer may be required.)

ON (interrupted)
Distance threshold
OFF (incident)
Conveyor (background)
Light level threshold (fixed)

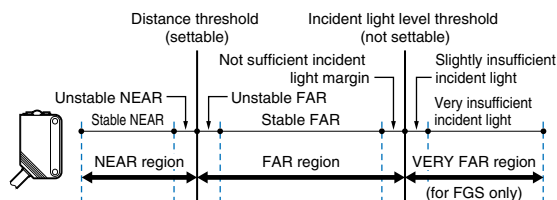

		BGS		FGS	
L/ON	Stability (green)	ON	OFF	ON	OFF
	Operation (orange)	ON	OFF	ON	OFF
D/ON	Stability (green)	ON	OFF	ON	OFF
	Operation (orange)	ON	OFF	ON	OFF
L/ON	Stability (green)	ON	OFF	ON	OFF
	Operation (orange)	ON	OFF	ON	OFF
D/ON	Stability (green)	ON	OFF	ON	OFF
	Operation (orange)	ON	OFF	ON	OFF

Precautions

Caution

Do not connect an AC power supply to the Sensor. If AC power (100 VAC or more) is supplied to the Sensor, it may explode or burn.

Be sure to abide by the following precautions for the safe operation of the Sensor.

Wiring

Power Supply Voltage and Output Load Power Supply Voltage

Make sure that the power supply to the Sensor is within the rated voltage range. If a voltage exceeding the rated voltage range is supplied to the Sensor, it may explode or burn.

Load Short-circuiting

Do not short-circuit the load, otherwise the Sensor may be damaged.

Connection without Load

Do not connect the power supply to the Sensor with no load connected, otherwise the internal elements may explode or burn.

Operating Environment

Do not use the Sensor in locations with explosive or flammable gas.

Correct Use

Design

Power Reset Time

The Sensor is ready to operate 100 ms after the Sensor is turned ON. If the load and Sensor are connected to independent power supplies respectively, be sure to turn ON the Sensor before supplying power to the load.

Wiring

Avoiding Malfunctions

If using the Photoelectric Sensor with an inverter or servomotor, always ground the FG (frame ground) and G (ground) terminals, otherwise the Sensor may malfunction.

Mounting

Mounting the Sensor

- If Sensors are mounted face-to-face, make sure that the optical axes are not in opposition to each other. Otherwise, mutual interference may result.
- Always install the Sensor carefully so that the aperture angle range of the Sensor will not cause it to be directly exposed to intensive light, such as sunlight, fluorescent light, or incandescent light.
- Do not strike the Photoelectric Sensor with a hammer or any other tool during the installation of the Sensor, or the Sensor will lose its water-resistive properties.

- Use M3 screws to mount the Sensor.
- When mounting the case, make sure that the tightening torque applied to each screw does not exceed 0.54 Nm.

M8 Connector

- Always turn OFF the power supply to the Sensor before connecting or disconnecting the metal connector.
- Hold the connector cover to connect or disconnect it.
- Secure the connector cover by hand. Do not use pliers, otherwise the connector may be damaged.
- If the connector is not connected securely, it may be disconnected by vibration or the proper degree of protection of the Sensor may not be maintained.

Distance setting models E3Z-LS

- Make sure that the sensing side of the Sensor is parallel with the surface of the sensing objects. Normally, do not incline the Sensor towards the sensing object.

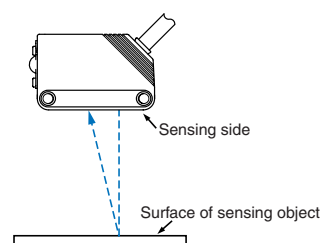

If the sensing object has a glossy surface, however, incline the Sensor by 5° to 10° as shown in the illustration, provided that the Sensor is not influenced by background objects.

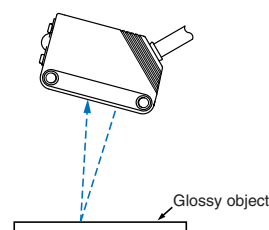

- If there is a mirror-like object below the Sensor, the Sensor may not operate stably. Therefore, incline the Sensor or separate the Sensor from the mirror-like object as shown below.

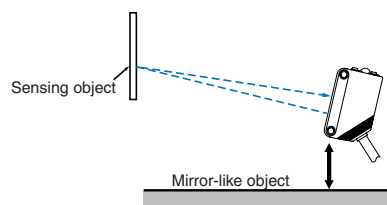

- Do not install the Sensor in the wrong direction. Refer to the following illustration.

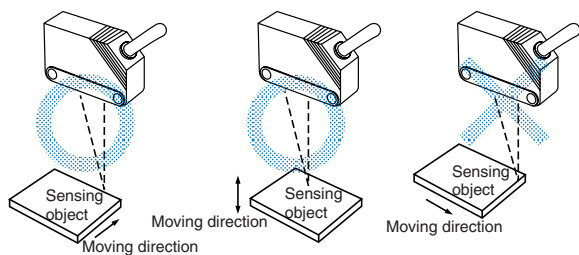

Install the Sensor as shown in the following illustration if each sensing object greatly differs in color or material.

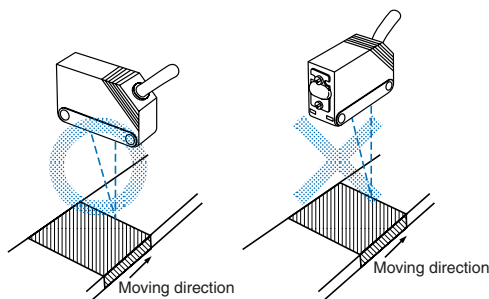

Adjustments-indicator operation

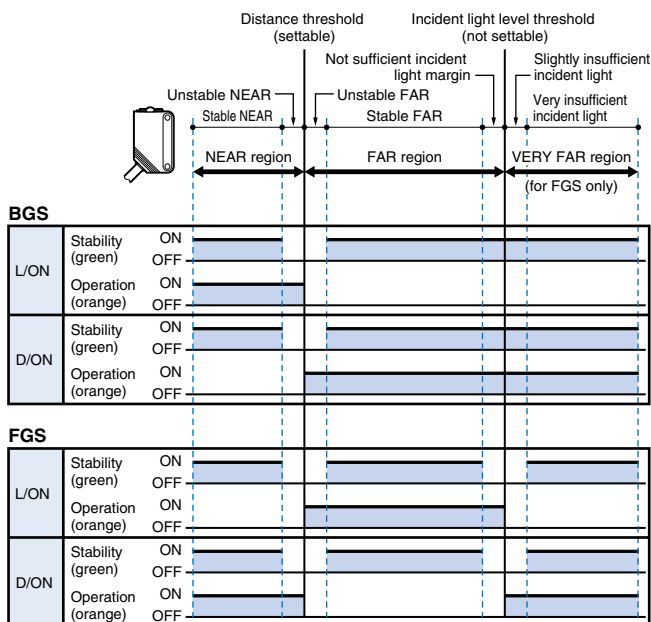

- Note: 1. If the stability indicator is lit, the detection/no detection status is stable within the rated ambient operating temperature (-25 to 55°C).
 2. The VERY FAR region is supported only for FGS. The incident light threshold is fixed and cannot be set. The distance to the incident light threshold depends on the color and gloss of the sensing object's surface.

Retro-reflective for transparent objects E3Z-B

Design

Bottles

The Sensor may be unable to achieve stable detection depending on the shape of bottles. Be sure to verify stable detection before using the Sensor.

Mounting

Sensor Mounting

If the Sensor fails to provide stable detection due to the shape of bottles, adjust the location and inclination of the Sensor.

Inspection and Maintenance

Cleaning

Never use paint thinners or other organic solvents to clean the surface of the product.

Dimensions (Unit: mm)

Sensors

Through-beam

Pre-wired

- E3Z-T61
- E3Z-T81
- E3Z-T61A

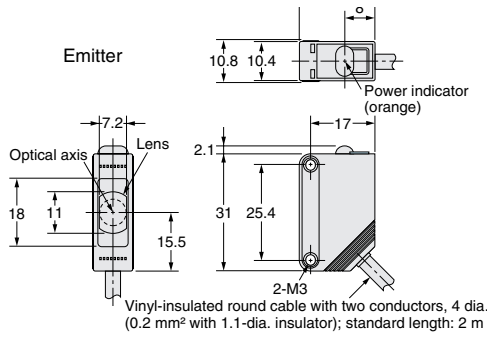

Connector relay models
E3Z-T61-M1J

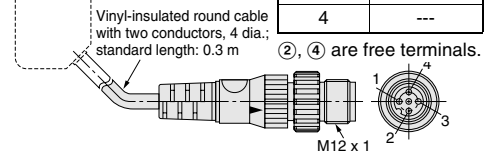

Terminal No.	Specifications
1	+V
2	---
3	0V
4	---

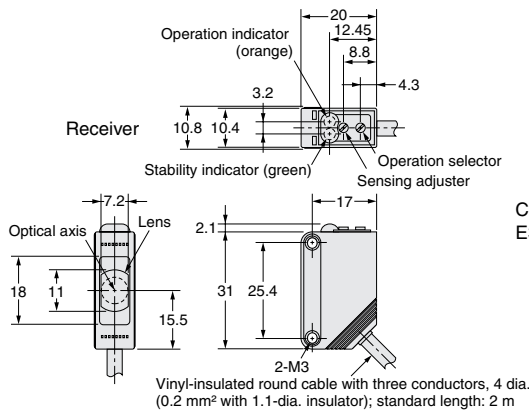

Connector relay models
E3Z-T61-M1J

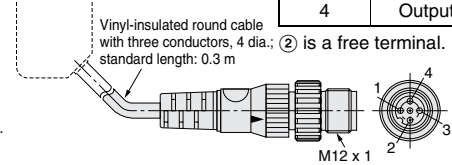

Terminal No.	Specifications
1	+V
2	---
3	0V
4	Output

Through-beam

Connector type

- E3Z-T66
- E3Z-T86
- E3Z-T66A

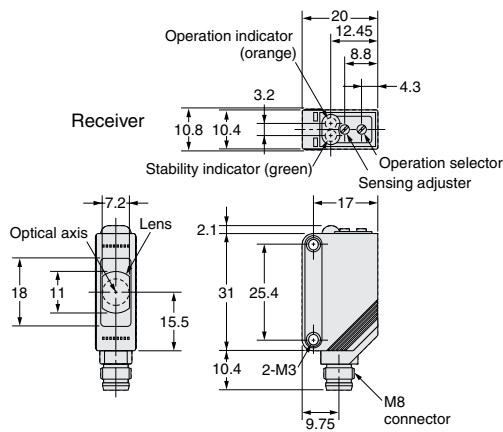
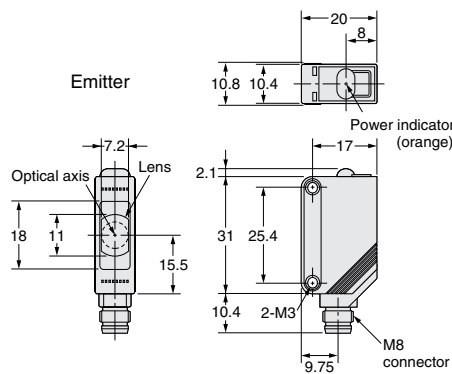

Retroreflective Models

Pre-wired

- E3Z-B61
- E3Z-B62
- E3Z-B81
- E3Z-B82
- E3Z-R61
- E3Z-R81

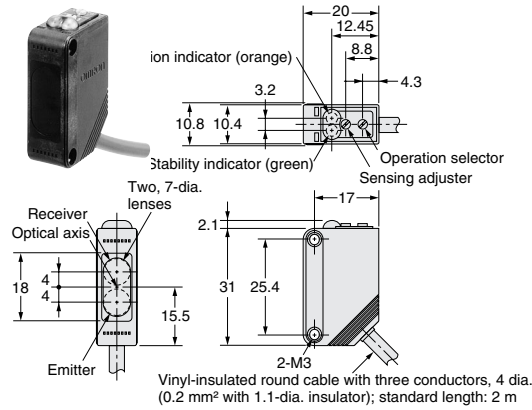

Connector relay models (E3Z-□□-M1J)

Terminal No.	Specifications
1	+V
2	---
3	0V
4	Output

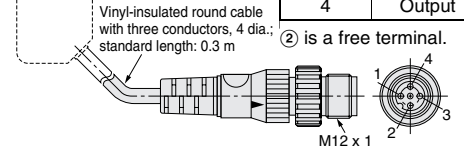

Diffuse-reflective

Pre-wired

- E3Z-D61
- E3Z-D81
- E3Z-D62
- E3Z-D82
- E3Z-L61
- E3Z-L81

Retroreflective Models

Connector type

- E3Z-B66
- E3Z-B67
- E3Z-B86
- E3Z-B87
- E3Z-R66
- E3Z-R86

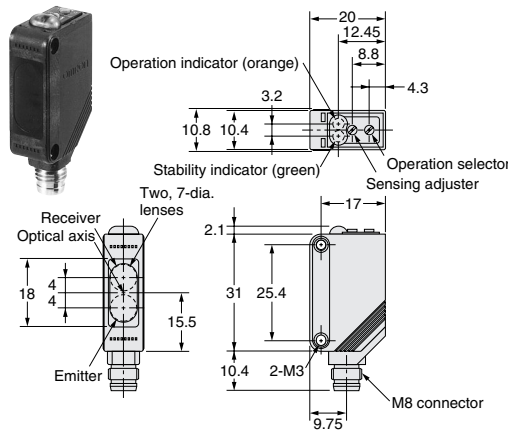

Diffuse-reflective

Connector type

- E3Z-D66
- E3Z-D86
- E3Z-D67
- E3Z-D87
- E3Z-L66
- E3Z-L86

Distance-settable Models

Pre-wired models

- E3Z-LS61
- E3Z-LS81

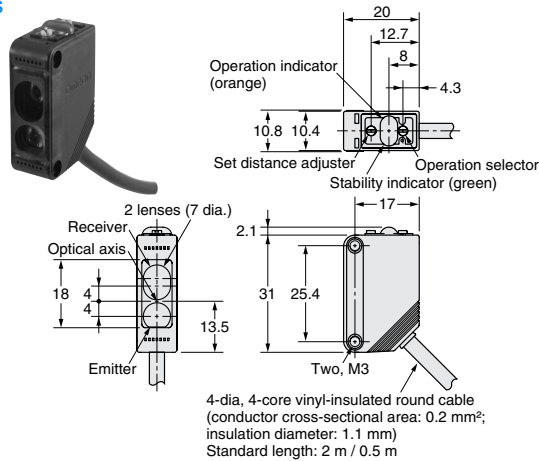

Distance-settable Models

Connector type
E3Z-LS66
E3Z-LS86

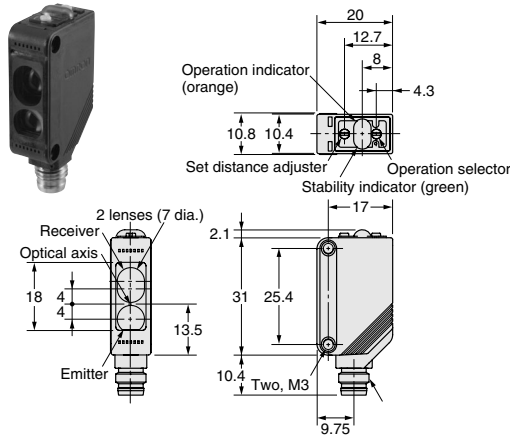

Grooved-type Models

E3Z-G

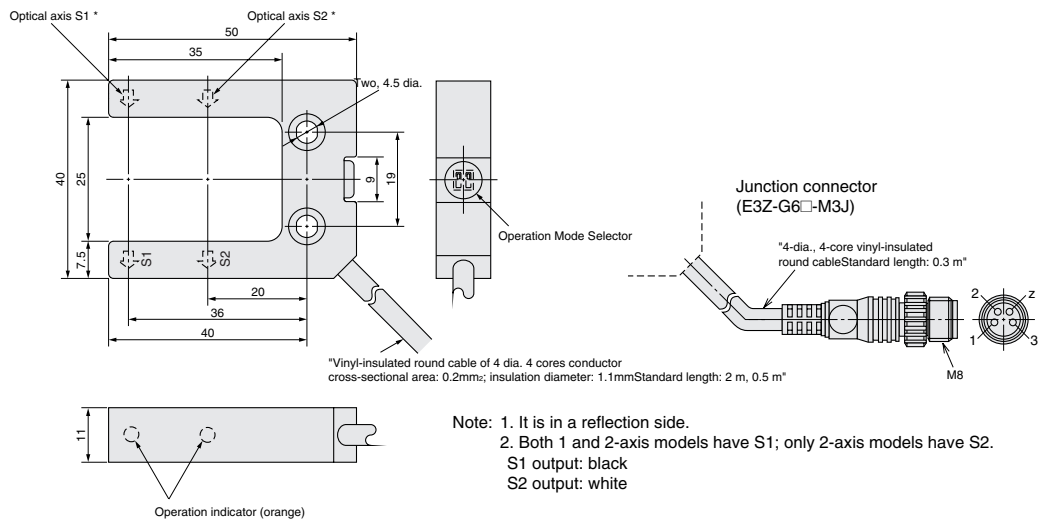

Accessories (Order Separately)

Slits

E39-S65A
E39-S65B
E39-S65C

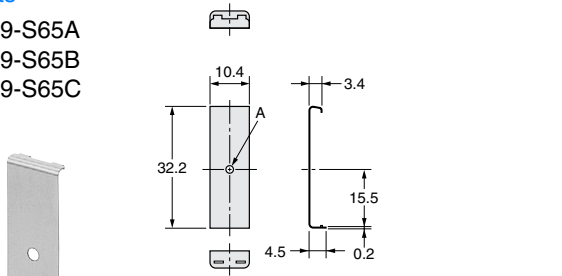

Model	Dimension A	Material
E39-S65A	0.5-mm dia.	Stainless steel (SUS301)
E39-S65B	1.0-mm dia.	
E39-S65C	2.0-mm dia.	

Slits

E39-S65D
E39-S65E
E39-S65F

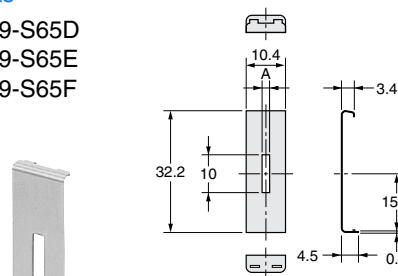

Model	Dimension A	Material
E39-S65D	0.5	Stainless steel (SUS301)
E39-S65E	1.0	
E39-S65F	2.0	

ALL DIMENSIONS SHOWN ARE IN MILLIMETERS.
To convert millimeters into inches, multiply by 0.03937. To convert grams into ounces, multiply by 0.03527.