

AC Filter for PCB Mounting Cost Optimized

Standard- or Medical-Filter



Description

- Chassis: PCB Mounting, from top
- Line filter in standard and medical version, 1-stage, standard attenuation
- For PCB-mounting or quick connect terminals
- Excellent price/performance ratio

Approvals

- VDE Certificate Number: 40004673
- UL File Number: E72928

Characteristics

- Cost-saving plastic housing
- Designed for standard applications
- Protection against interference voltage from the mains
- Possible interferences generated in the equipment are strongly attenuated
- For standard applications
- Suitable for use in equipment according to IEC/UL 60950

Other versions on request

- Version with wire connection
- Medical version M80

References

Alternative: Standard version

Weblinks

[pdf-datasheet](#), [html-datasheet](#), [General Product Information](#), [Approvals](#), [CE declaration of conformity](#), [RoHS](#), [CHINA-RoHS](#), [REACH](#), [e-Shop](#), [SCHURTER-Stock-Check](#), [Distributor-Stock-Check](#), [Detailed request for product](#)

Technical Data

Ratings IEC	0.6 - 6A @ Ta 40 °C / 250VAC; 50Hz	Line Filter	Standard and Medical Version, IEC 60939, UL 1283, CSA C22.2 no. 8
Ratings UL/CSA	0.6 - 6A @ Ta 40 °C / 125VAC; 60Hz		Technical Details
Leakage Current	standard < 0.25 mA (250V / 60Hz) medical < 5 µA (250 V / 60 Hz)	MTBF	> 200'000h acc. to MIL-HB-217 F
Dielectric Strength	> 1.7 kVDC between L-N > 2.7 kVDC between L/N-PE Test voltage (2 sec)		
Allowable Operation Temp.	-25 °C to 85 °C		
Climatic Category	25/085/21 acc. to IEC 60068-1		
Protection Class	Suitable for appliances with protection class I acc. to IEC 61140		
Terminal	For PCB mounting , tin-plated		
Material: Housing	Thermoplastic, black, UL 94V-0		

Dimension

Case 13P

Case 18P

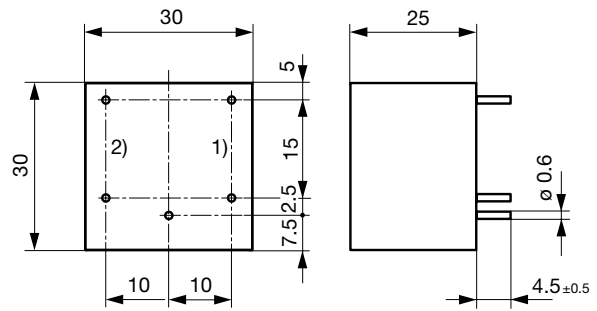
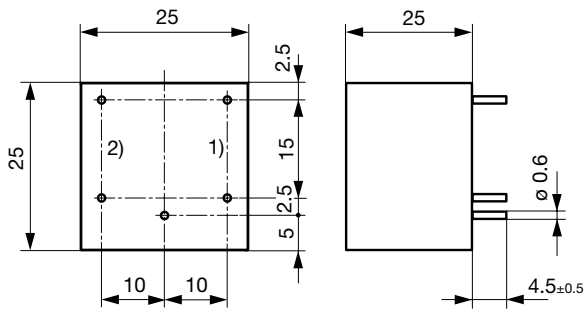

Case 24P

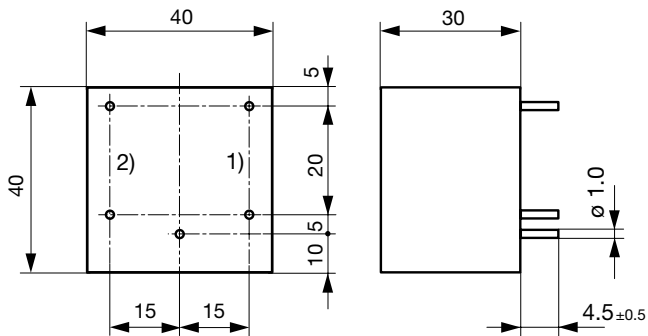

1) Line
2) Load

Diagrams

S1 standard version

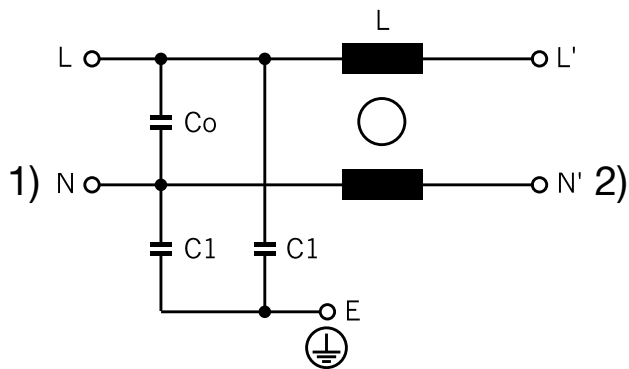

1) Line
2) Load

S2 medical version

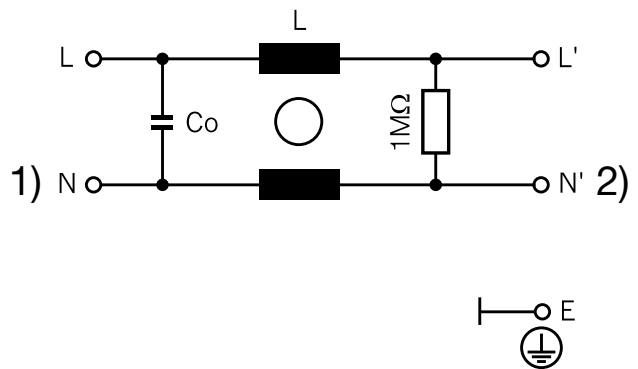

1) Line
2) Load

Attenuation Loss

---- differential mode ____ common mode

Standard version
0.6 A

1 A

2 A

4 A

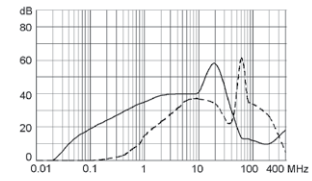
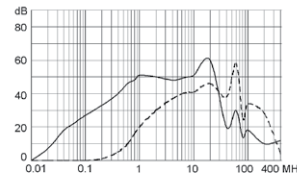
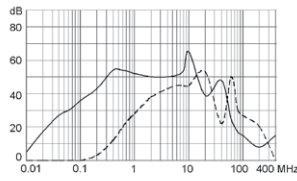
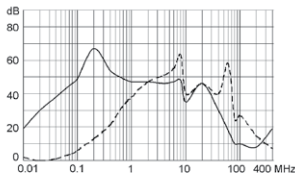

6 A

0.7 A

1 A

2 A

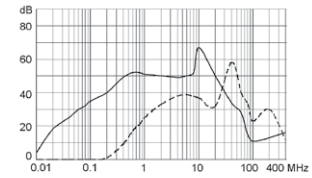
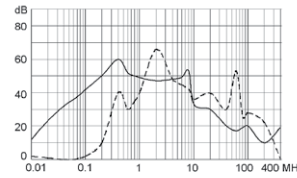
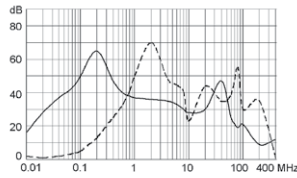
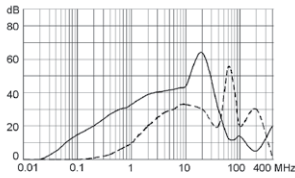

3 A

1 A

3 A

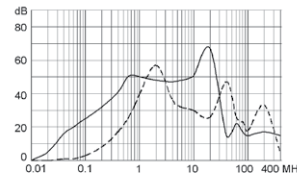
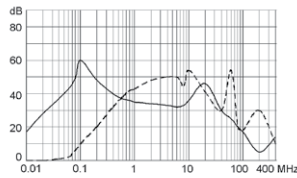
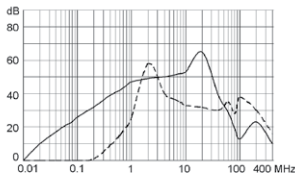

Medical version (M5)
0.6 A

1 A

2 A

4 A

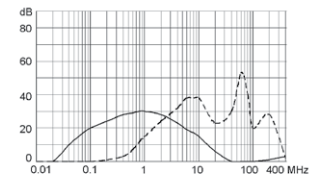
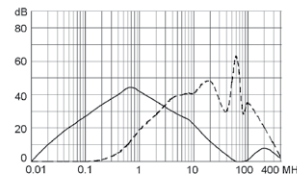
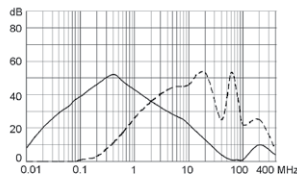
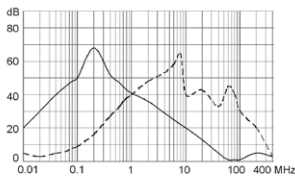

6 A

0.7 A

1 A

2 A

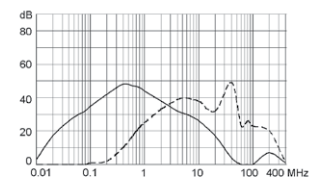
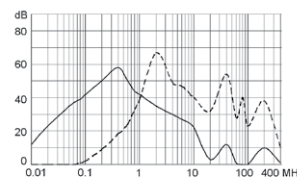
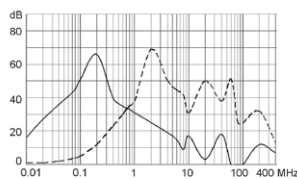
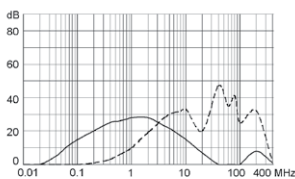

3 A

1 A

3 A

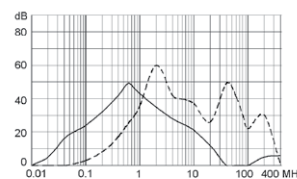
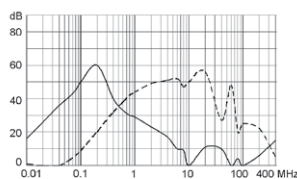
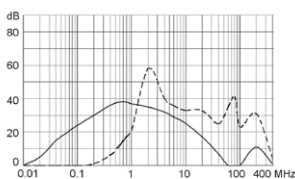

All Variants

Rated Current [A]	Filter-Type	L [mH]	Co / C2 (X2) [µF]	C1 (Y2) [nF]	Diagram	Weight [g]	Housing	Order Number
0.6	Standard Version	2 x 40	0.015	2.2	S1	27 g	13P	5500.2000
1	Standard Version	2 x 10	0.015	2.2	S1	27 g	13P	5500.2001
2	Standard Version	2 x 4	0.015	2.2	S1	27 g	13P	5500.2002
4	Standard Version	2 x 1.5	0.015	2.2	S1	27 g	13P	5500.2003
6	Standard Version	2 x 0.8	0.015	2.2	S1	35 g	13P	5500.2004
0.7	Standard Version	2 x 40	0.015	2.2	S1	32 g	18P	5500.2005
1	Standard Version	2 x 20	0.022	2.2	S1	32 g	18P	5500.2006
2	Standard Version	2 x 6	0.022	2.2	S1	32 g	18P	5500.2007
3	Standard Version	2 x 3	0.022	2.2	S1	32 g	18P	5500.2008
1	Standard Version	2 x 30	0.047	2.2	S1	78 g	24P	5500.2009
3	Standard Version	2 x 4	0.047	2.2	S1	78 g	24P	5500.2010
0.6	Medical Version (M5)	2 x 40	0.015	-	S2	35 g	13P	5500.2116
1	Medical Version (M5)	2 x 10	0.015	-	S2	35 g	13P	5500.2117
2	Medical Version (M5)	2 x 4	0.015	-	S2	25.5 g	13P	5500.2118
4	Medical Version (M5)	2 x 1.5	0.015	-	S2	35 g	13P	5500.2119
6	Medical Version (M5)	2 x 0.8	0.015	-	S2	35 g	13P	5500.2120
0.7	Medical Version (M5)	2 x 40	0.015	-	S2	45 g	18P	5500.2121
1	Medical Version (M5)	2 x 20	0.022	-	S2	45 g	18P	5500.2122
2	Medical Version (M5)	2 x 6	0.022	-	S2	45 g	18P	5500.2123
3	Medical Version (M5)	2 x 3	0.022	-	S2	45 g	18P	5500.2124
1	Medical Version (M5)	2 x 30	0.047	-	S2	78 g	24P	5500.2125
3	Medical Version (M5)	2 x 4	0.047	-	S2	78 g	24P	5500.2126

Most Popular:

Availability for all products can be searched real-time: <http://www.schurter.com/en/Stock-Check/Stock-Check-SCHURTER>

Packaging unit 50 Pcs