



Features

- -60dBc ACPR at 15.5dBm WCDMA
- 0.5W Output Power (P1dB)
- NF = 3.8dB at 2140MHz
- Gain = 15.7dB at 2140MHz
- Power-Down Capability

Applications

- GaAs Pre-Driver for Base Station Amplifiers
- PA Stage for Commercial Wireless Infrastructure
- 2nd or 3rd Stage LNAs
- Class AB Operation for GSM, DCS, PCS, UMTS, WiMAX, TD-SCDMA, LTE Transceiver Applications

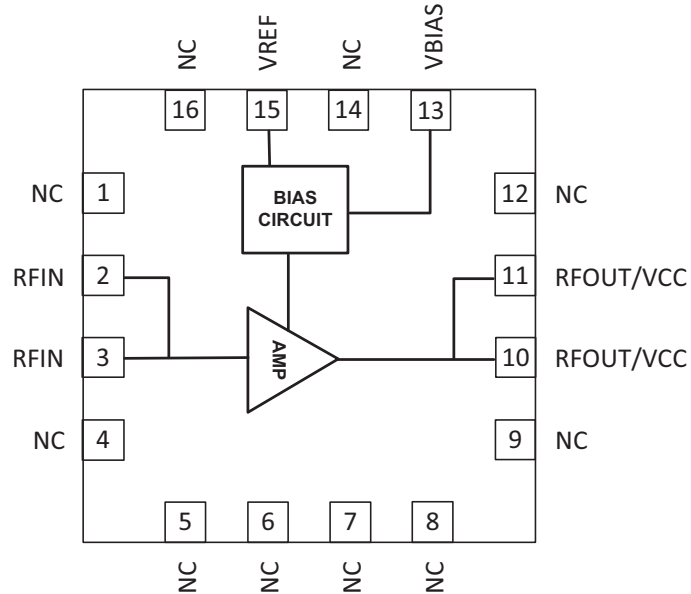

Functional Block Diagram

Product Description

The RFPA2013 is a single-stage GaAs HBT power amplifier specifically designed for Wireless Infrastructure applications. It offers ultra-linear operation at a comparably low DC power, making it ideal for next generation radios requiring high efficiency. Its external matching allows for use across various radio platforms within 400MHz to 2700MHz. The RFPA2013 offers a low noise figure, making it an excellent solution for 2nd and 3rd stage LNAs.

Ordering Information

RFPA2013SR	7" Sample reel with 100 pieces
RFPA2013SQ	Sample bag with 25 pieces
RFPA2013TR7	7" Reel with 2500 pieces
RFPA2013PCK-410	2110MHz to 2170MHz PCBA with 5-piece sample bag
RFPA2013PCK-411	2600MHz to 2700MHz PCBA with 5-piece sample bag
RFPA2013PCK-412	2550MHz to 2650MHz PCBA with 5-piece sample bag
869MHz to 894MHz	PCBA Not Available Online, Contact Product Line Apps

Absolute Maximum Ratings

Parameter	Rating	Unit
Supply Voltage (V_{CC} , V_{BIAS})	6.0	V
DC Supply Current (I_{CC})	380	mA
CW Input Power, 2:1 Output VSWR	20	dBm
Output Load VSWR at P3dB	5:1	
Operating Junction Temperature	160	°C
Operating Temperature Range (T_L)	-40 to +85	°C
Storage Temperature	-40 to +150	°C
ESD Rating - Human Body Model (HBM)	Class 1C	
Moisture Sensitivity Level	MSL-1	

Notes:

1. The maximum ratings must all be met simultaneously.
2. $P_{DISS} = P_{DC} + P_{RFIN} - P_{RFOUT}$
3. $T_J = T_L + P_{DISS} * R_{TH}$



Caution! ESD sensitive device.

Exceeding any one or a combination of the Absolute Maximum Rating conditions may cause permanent damage to the device. Extended application of Absolute Maximum Rating conditions to the device may reduce device reliability. Specified typical performance or functional operation of the device under Absolute Maximum Rating conditions is not implied.

The information in this publication is believed to be accurate and reliable. However, no responsibility is assumed by RF Micro Devices, Inc. ("RFMD") for its use, nor for any infringement of patents, or other rights of third parties, resulting from its use. No license is granted by implication or otherwise under any patent or patent rights of RFMD. RFMD reserves the right to change component circuitry, recommended application circuitry and specifications at any time without prior notice.

Parameter	Specification			Unit	Condition
	Min.	Typ.	Max.		
869MHz to 894MHz					$V_{CC} = 5.0V$, $I_{CC} = 165mA$, linear tune
Frequency		880		MHz	EVB tuned for WCDMA 60dBc linear operation
Input Power (P_{IN})			10	dBm	Max recommended continuous input power, $V_{CC} < 6.0V$, load VSWR < 2:1
Gain (S21)		21.8		dB	
OIP3		41		dBm	15dBm/tone, tone spacing = 1MHz
P1dB		27.5		dBm	EVB tuned for linear operation
Input Return Loss (S11)		14		dB	
Output Return Loss (S22)		8		dB	
Noise Figure		3.8		dB	
WCDMA Channel Power at -55dBc ACPR		16.5		dBm	3GPP 3.5, test model 1, 64 DPCH
2110MHz to 2170MHz					$V_{CC} = 5.0V$, $I_{CC} = 165mA$, linear tune
Frequency		2140		MHz	EVB tuned for WCDMA 60dBc linear operation
Input Power (P_{IN})			16	dBm	Max recommended continuous input power, $V_{CC} < 6.0V$, load VSWR < 2:1
Gain (S21)		15.7		dB	
OIP3		41.5		dBm	15dBm/tone, tone spacing = 1MHz
P1dB		27		dBm	EVB tuned for linear operation
Input Return Loss (S11)		14		dB	
Output Return Loss (S22)		10.5		dB	
Noise Figure		3.8		dB	
WCDMA Channel Power at -55dBc ACPR		16.5		dBm	3GPP 3.5, test model 1, 64 DPCH

Parameter	Specification			Unit	Condition
	Min.	Typ.	Max.		
2550MHz to 2650MHz					$V_{CC} = 5.0V, I_{CQ} = 165mA$, linear tune
Frequency		2600		MHz	EVB tuned for WCDMA 60dBc linear operation
Input Power (P_{IN})			17	dBm	Max recommended continuous input power, $V_{CC} < 6.0V$, load VSWR < 2:1
Gain (S21)		14.1		dB	
OIP3		41		dBm	15dBm/tone, tone spacing = 1MHz
P1dB		26.8		dBm	EVB tuned for linear operation
Input Return Loss (S11)		12.5		dB	
Output Return Loss (S22)		12		dB	
Noise Figure		3.4		dB	
WCDMA Channel Power at -55dBc ACPR		16.0		dBm	3GPP 3.5, test model 1, 64 DPCH
2600MHz to 2700MHz					$V_{CC} = 5.0V, I_{CQ} = 165mA$, linear tune
Frequency		2650		MHz	EVB tuned for WCDMA 60dBc linear operation
Input Power (P_{IN})			17	dBm	Max recommended continuous input power, $V_{CC} < 6.0V$, load VSWR < 2:1
Gain (S21)		14.4		dB	
OIP3		40		dBm	15dBm/tone, tone spacing = 1MHz
P1dB		27		dBm	EVB tuned for linear operation
Input Return Loss (S11)		13.5		dB	
Output Return Loss (S22)		13.5		dB	
Noise Figure		3.4		dB	
WCDMA Channel Power at -55dBc ACPR		16.0		dBm	3GPP 3.5, test model 1, 64 DPCH
Power Supply					
Operating Current (Quiescent)		165		mA	At $V_{BIAS} = V_{CC} = 5.0V$
Operating Voltage (V_{CC})		5.0	6.0	V	Max recommended collector voltage
Operating Voltage (V_{BIAS})		5.0	6.0	V	$V_{BIAS} = V_{CC}$ under normal operating conditions
Power Down Current		10		μA	$V_{REF} = 0V, V_{BIAS} = V_{CC} = 5.0V$
Thermal Resistance (R_{TH}) (Junction to EPAD)		60		C/W	Quiescent conditions

Typical Performance: 869MHz to 894MHz Application Circuit

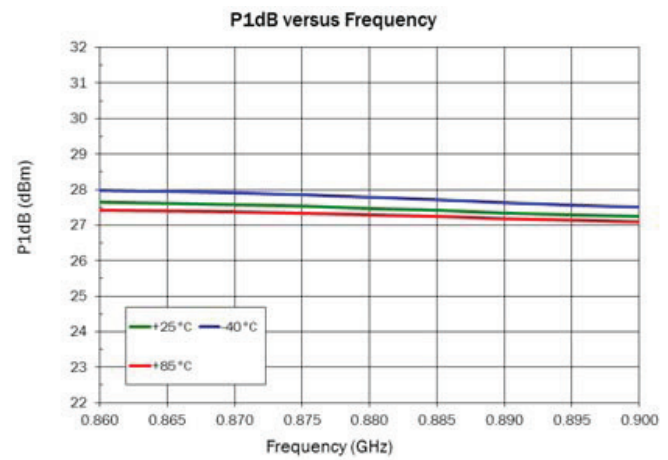
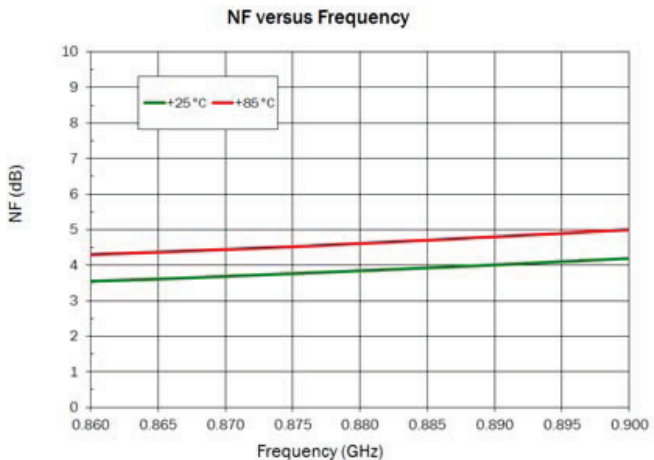
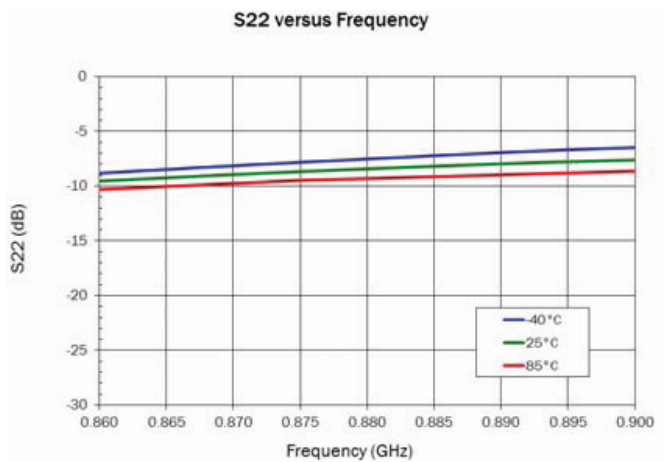
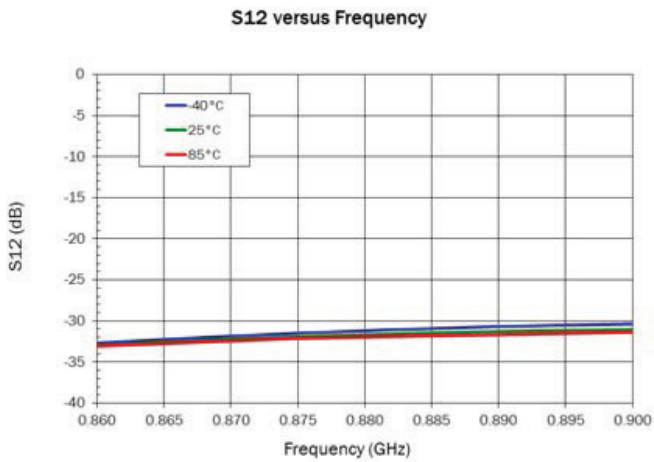
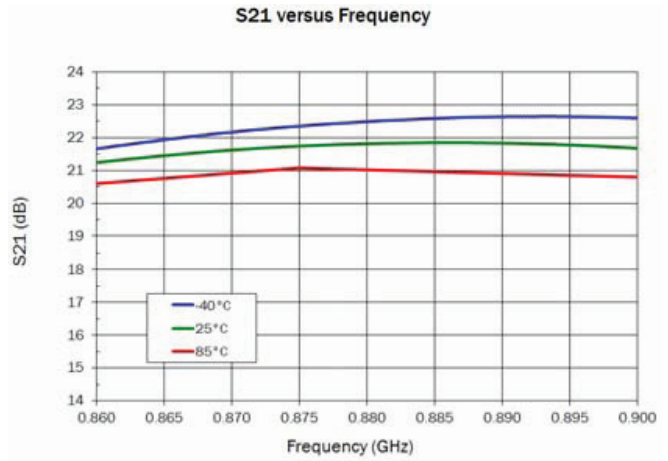
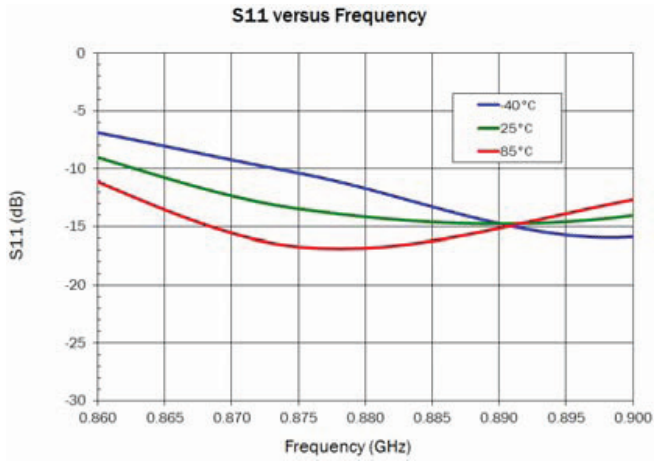

Typical Performance: 869MHz to 894MHz Application Circuit

OIP3 versus Frequency (15dBm tones)

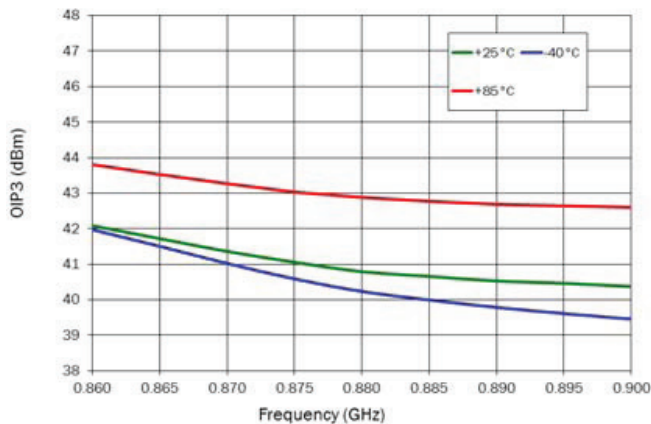

Output Power and Icc versus Input Power at 880MHz

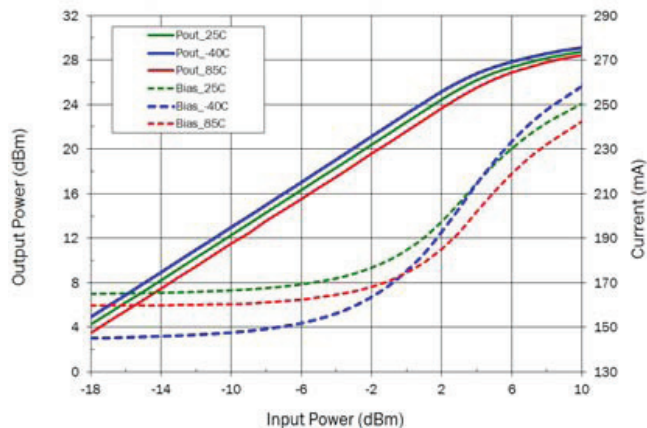

OIP3 versus Output Power (880MHz)

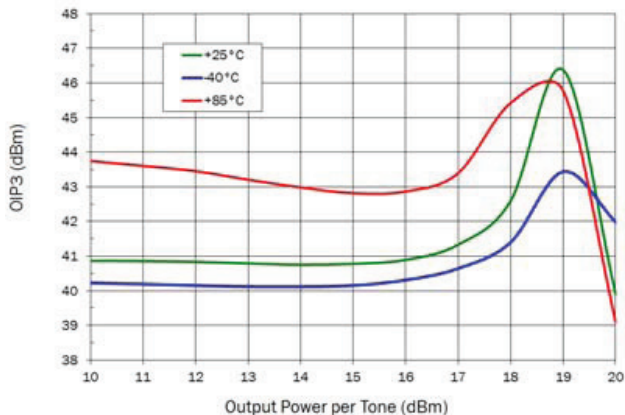

ACPR versus WCDMA Output Power (25C)

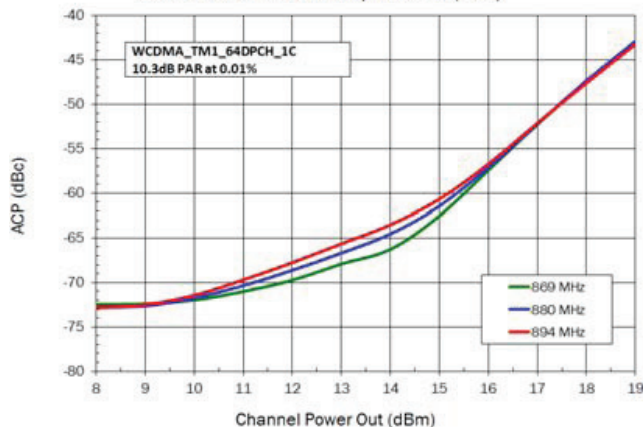

ACPR versus WCDMA Output Power (880MHz)

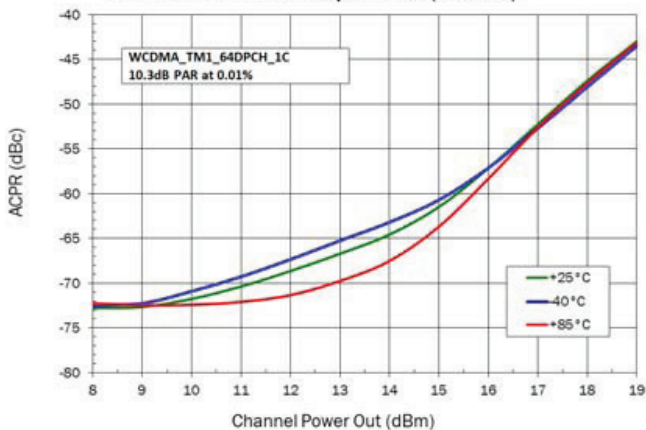

Evaluation Board Schematic 869MHz to 894MHz Application Circuit

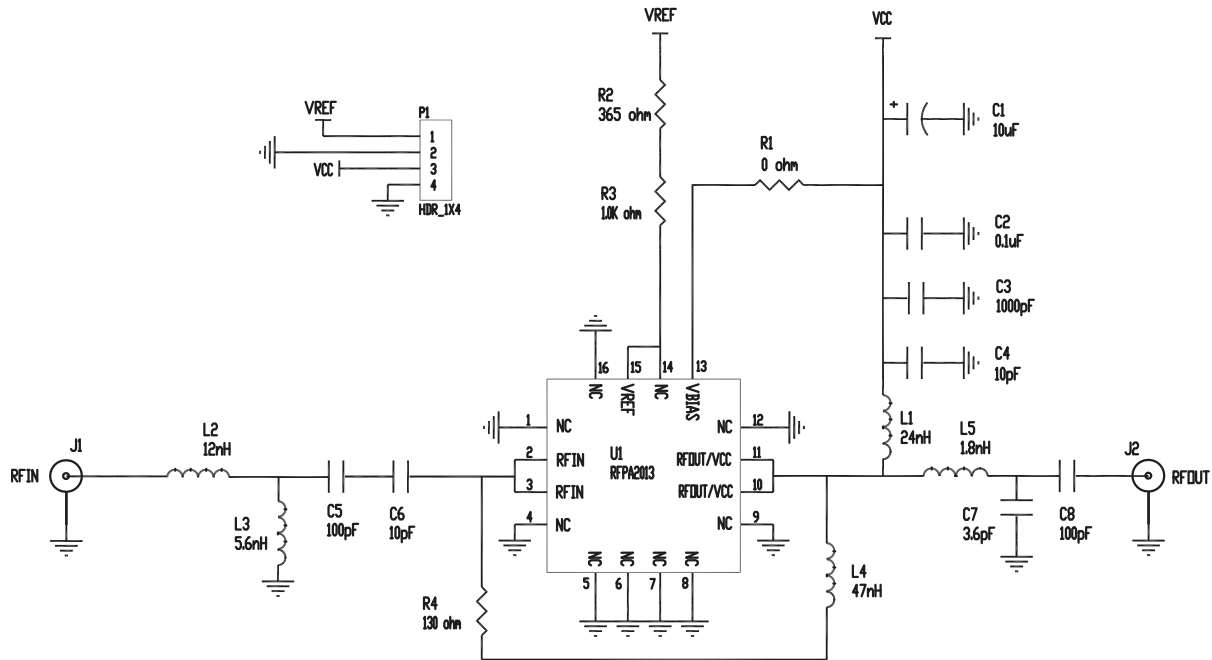

Evaluation Board Bill of Materials (BOM) 869MHz to 894MHz Application Circuit

Description	Reference Designator	Manufacturer	Manufacturer's P/N
Evaluation Board			PA2013411(A)
GaAs HBT Power Amplifier	U1	RFMD	RFPA2013
CAP, 10 μ F, 20%, 10V, TANT-A	C1	Kemet	T491A106M010AT
CAP, 0.1 μ F, 10%, 16V, X7R, 0402	C2	Murata Electronics	GRM155R71C104KA88D
CAP, 1000pF, 10%, 50V, X7R, 0402	C3	Murata Electronics	GRM155R71H102KA01D
CAP, 10pF, 5%, 50V, COG, 0402	C4, C6	Murata Electronics	GRM1555C1H100JZ01E
CAP, 100pF, 5%, 50V, COG, 0402	C5, C8	Murata Electronics	GRM1555C1H101JA01D
CAP, 3.6pF, \pm 0.25pF, 50V, COG, 0402	C7	Murata Electronics	GRM1555C1H3R6CZ01E
CONN, SMA, END LNCH, MINI, FLT, 0.068"	J1, J2	Emerson Networks	142-0741-851
IND, 24nH, 5%, W/W, 0603	L1	Coilcraft, Inc.	0603HC-24NXJLW
IND, 12nH, 10%, M/L, 0402	L2	TOKO Inc.	LL1005-FHL12NJ
IND, 5.6nH, \pm 0.3nH, M/L, 0402	L3	TOKO Inc.	LL1005-FH5N6S
IND, 47nH, 5%, M/L, 0402	L4	TOKO Inc.	LL1005-FH47NJ
IND, 1.8nH, \pm 0.3nH, M/L, 0402	L5	TOKO Inc.	LL1005-FH1N8S
CONN, HDR, ST, PLRZD, 4-PIN, 0.100"	P1	ITW Pancon	MPSS100-4-C
RES, 0 Ω , 0402	R1	KAMAYA, INC	RMC1/16SJPTH
RES, 365 Ω , 1%, 1/16W, 0402	R2	PANASONIC INDUSTRIAL CO	ERJ-2RKF3650
RES, 1.0K, 1%, 1/16W, 0402	R3	PANASONIC INDUSTRIAL CO	ERJ-2RKF1001
RES, 130 Ω , 5%, 1/16W, 0402	R4	PANASONIC INDUSTRIAL CO	ERJ-2GEJ131

Evaluation Board Assembly Drawing
869MHz to 894MHz Application Circuit

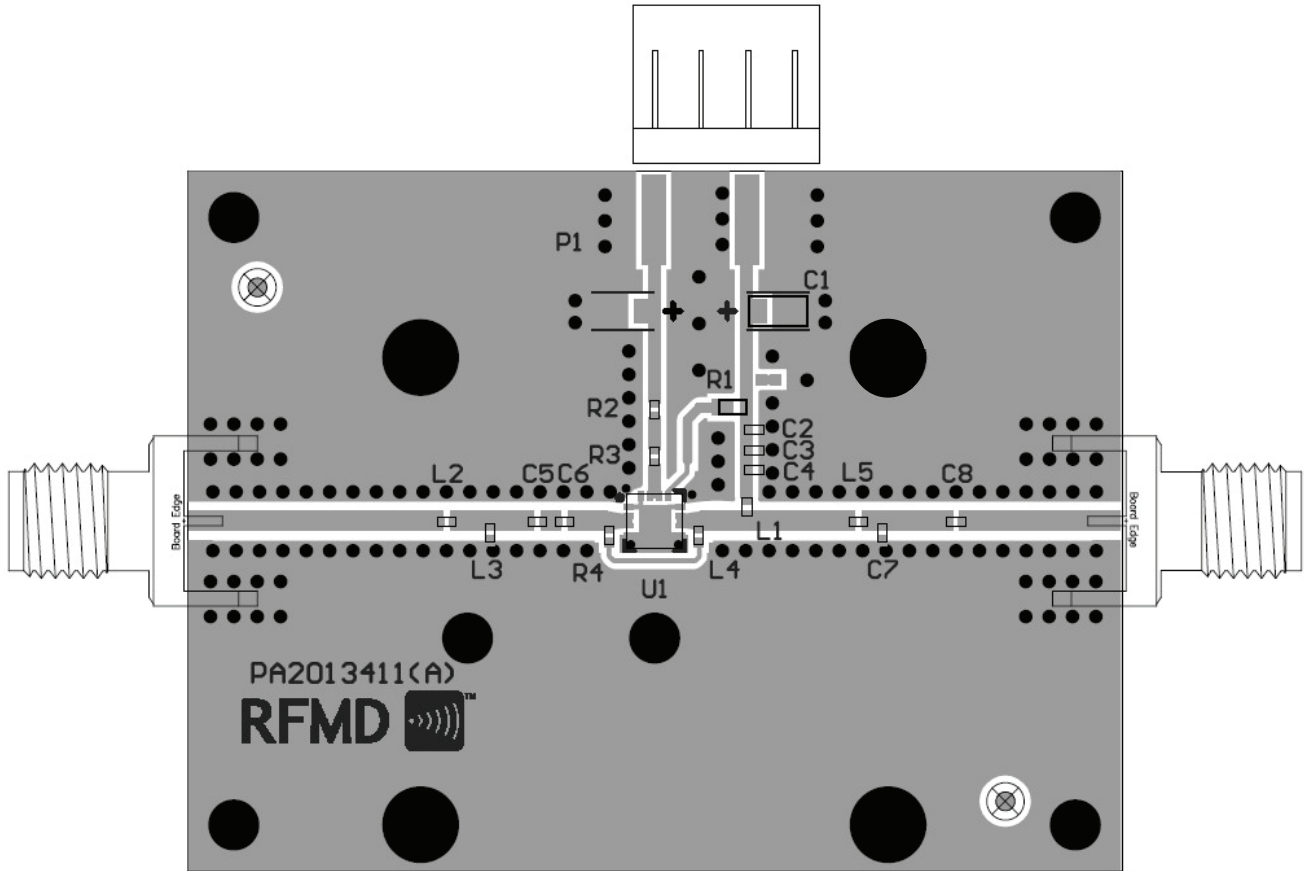

Typical Performance: 2110MHz to 2170MHz Application Circuit

S11 versus Frequency

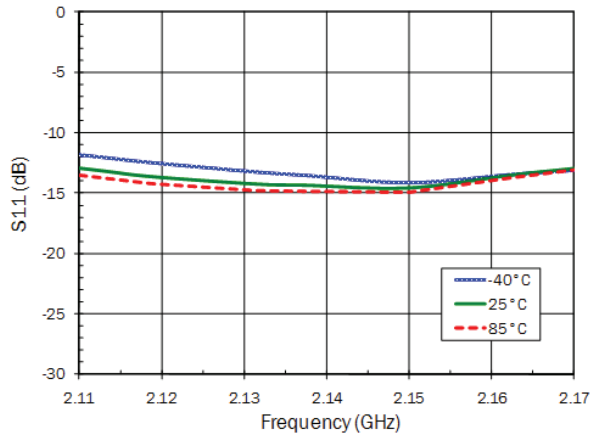

S21 versus Frequency

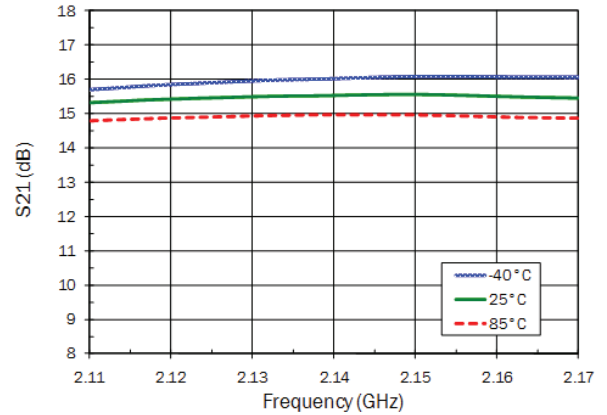

S12 versus Frequency

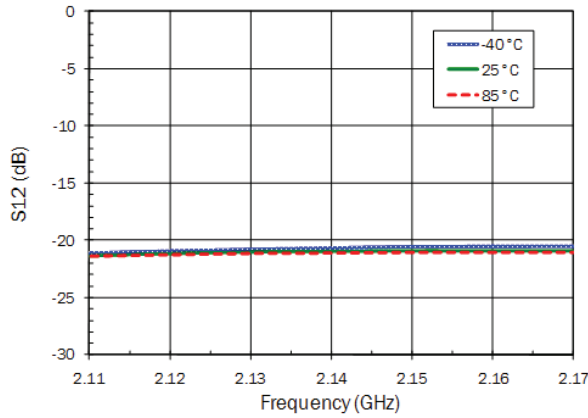

S22 versus Frequency

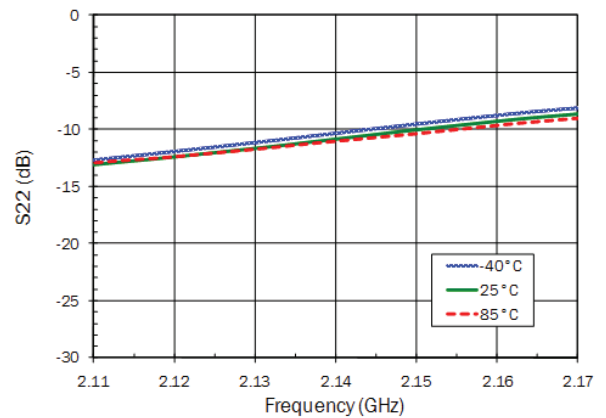

Noise Figure versus Frequency

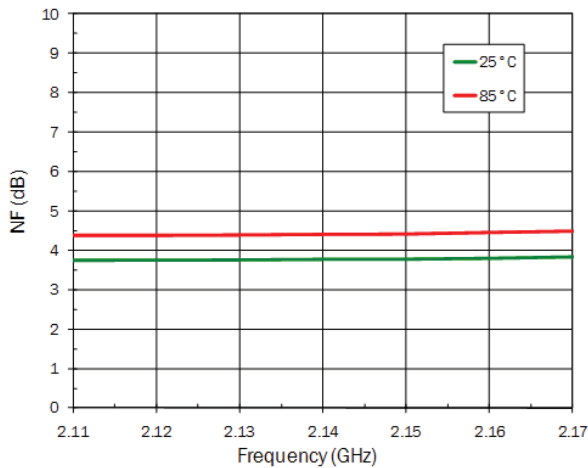

P1dB versus Frequency

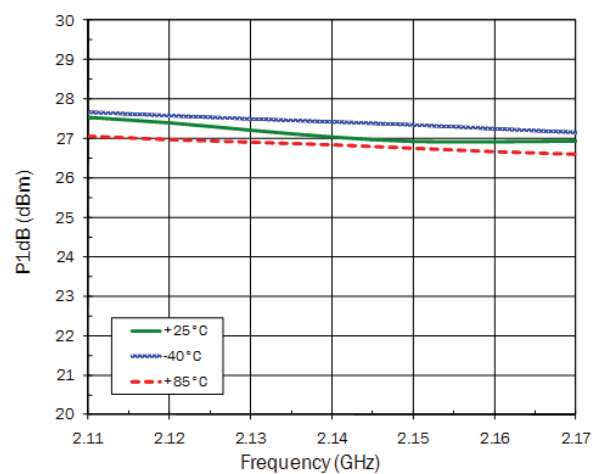

Typical Performance: 2110MHz to 2170MHz Application Circuit

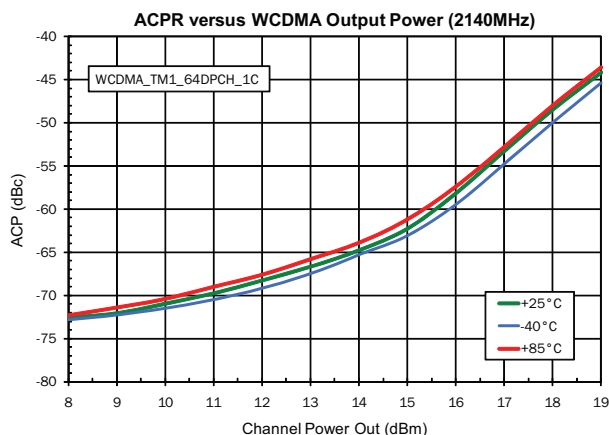
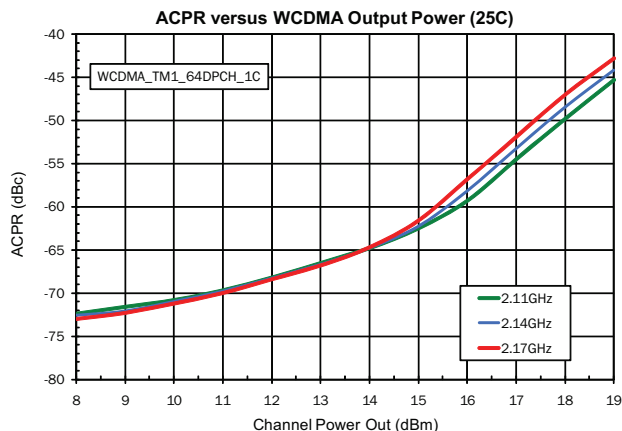
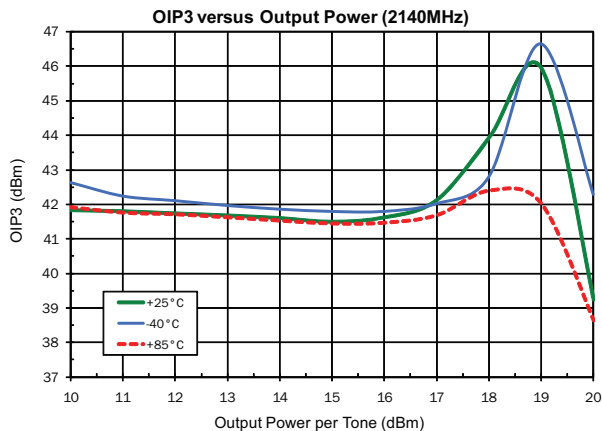
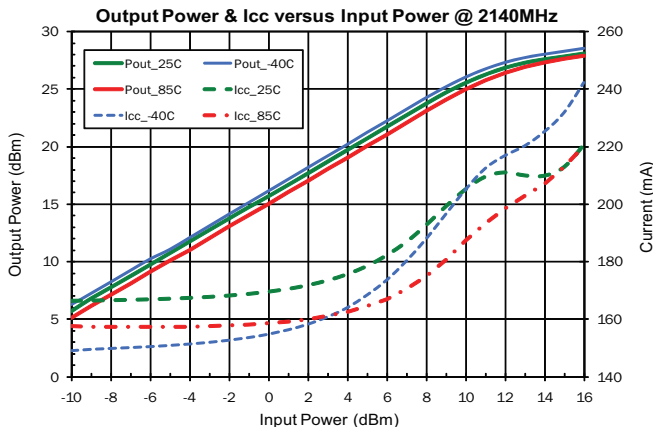
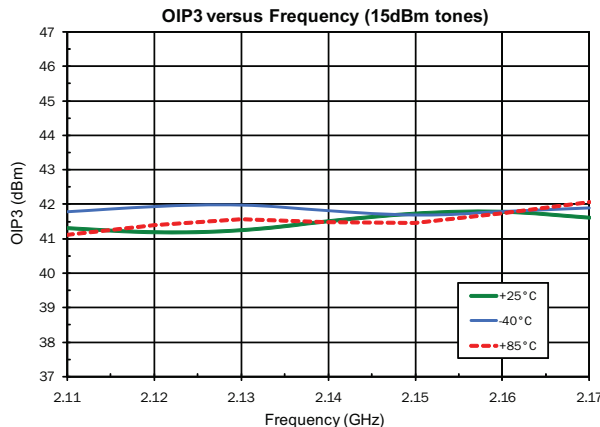

Evaluation Board Schematic 2110MHz to 2170MHz Application Circuit

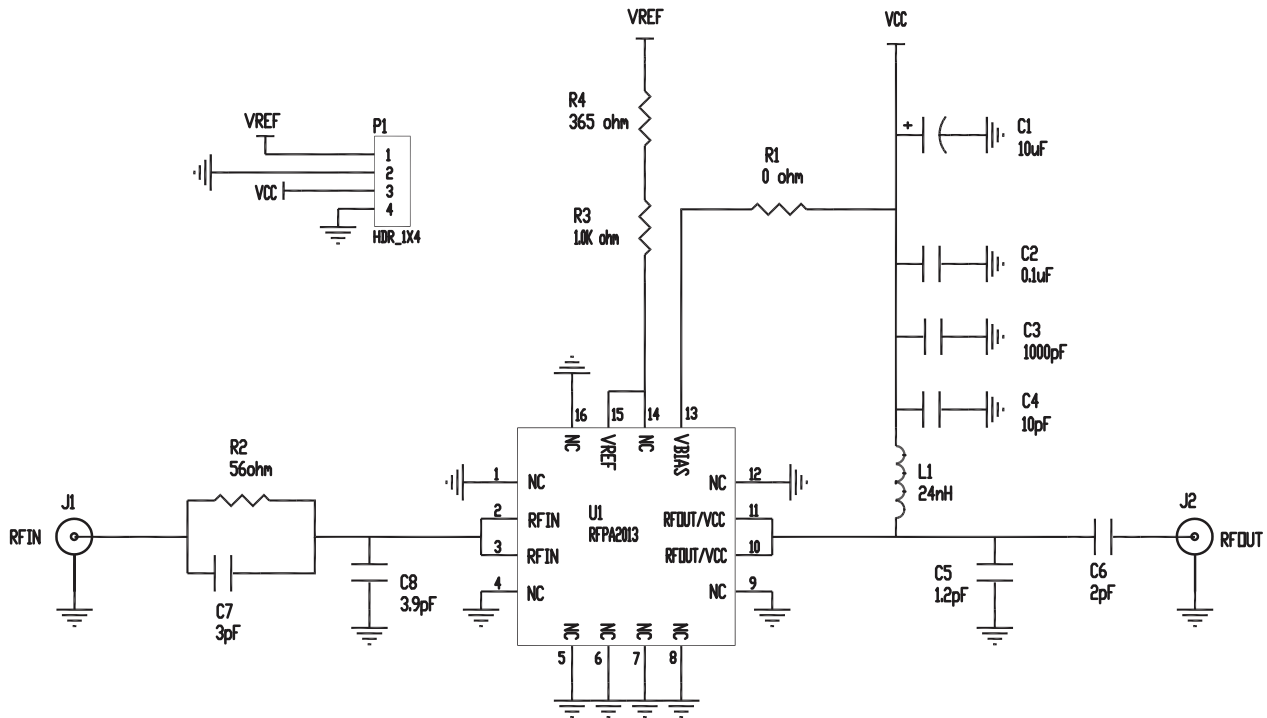

Evaluation Board Bill of Materials (BOM) 2110MHz to 2170MHz Application Circuit

Description	Reference Designator	Manufacturer	Manufacturer's P/N
Evaluation Board			PA2013410(B)
GaAs HBT Power Amplifier	U1	RFMD	RFPA2013
CAP, 10μF, 20%, 10V, TANT-A	C1	Kemet	T491A106M010AT
CAP, 0.1μF, 10%, 16V, X7R, 0402	C2	Murata Electronics	GRM155R71C104KA88D
CAP, 1000pF, 10%, 50V, X7R, 0402	C3	Murata Electronics	GRM155R71H102KA01D
CAP, 10pF, 5%, 50V, COG, 0402	C4	Murata Electronics	GRM1555C1H100JZ01E
CAP, 1.2pF, ±1pF, 50V, HI-Q, 0402	C5	Johanson Technology	500R07S1R2BV4TD
CAP, 2pF, ±0.1pF, 50V, COG, 0402	C6	Murata Electronics	GRM1555C1H2R0BZ01E
CAP, 3pF, ±1pF, 50V, COG, 0402	C7	Murata Electronics	GRM1555C1H3R0BZ01E
CAP, 3.9pF, ±0.25pF, 50V, COG, 0402	C8	Murata Electronics	GRM1555C1H3R9CZ01E
CONN, SMA, END LNCH, MINI, FLT, 0.068"	J1, J2	Emerson Networks	142-0741-851
IND, 24nH, 5%, W/W, 0603	L1	Coilcraft, Inc.	0603HC-24NXJLW
CONN, HDR, ST, PLRZD, 4-PIN, 0.100"	P1	ITW Pancon	MPSS100-4-C
RES, 0Ω, 0402	R1	KAMAYA, INC	RMCI/16SJPTH
RES, 56Ω, 5%, 1/16W, 0402	R2	PANASONIC INDUSTRIAL CO	ERJ-2GEJ560
RES, 1.0K, 1%, 1/16W, 0402	R3	PANASONIC INDUSTRIAL CO	ERJ-2RKF1001
RES, 365Ω, 1%, 1/16W, 0402	R4	PANASONIC INDUSTRIAL CO	ERJ-2RKF3650
DO NOT PLACE (DNP)	R5, R6, C9-C21		

Typical Performance: 2550MHz to 2650MHz Application Circuit

S11 versus Frequency

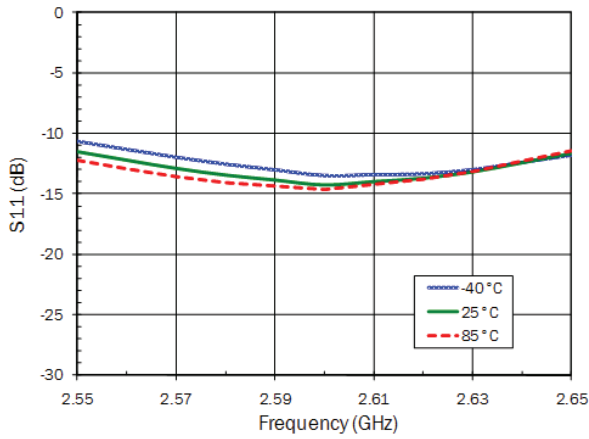

S21 versus Frequency

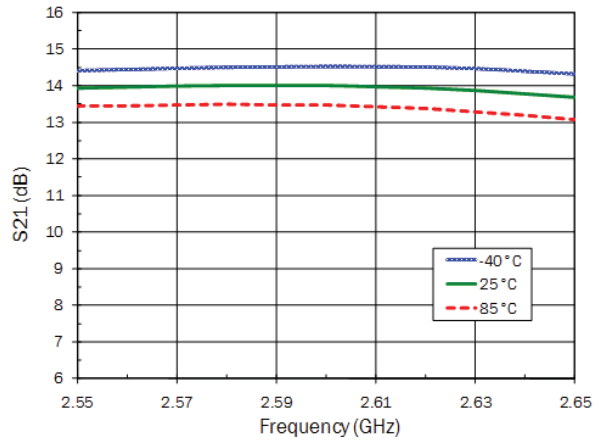

S12 versus Frequency

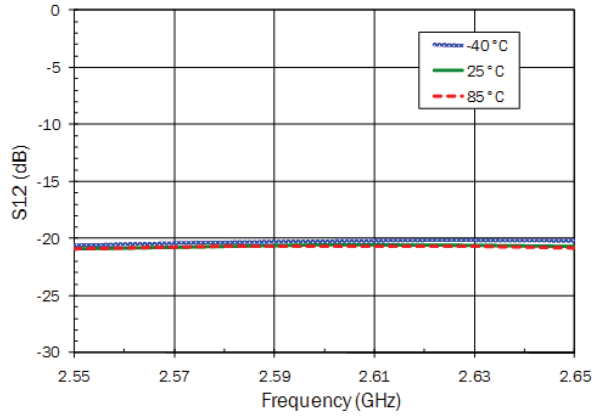

S22 versus Frequency

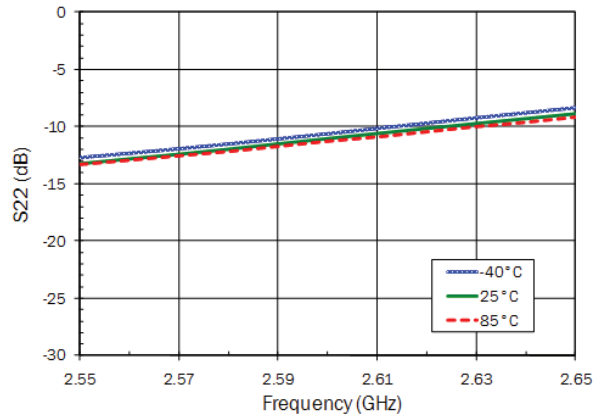

Noise Figure versus Frequency

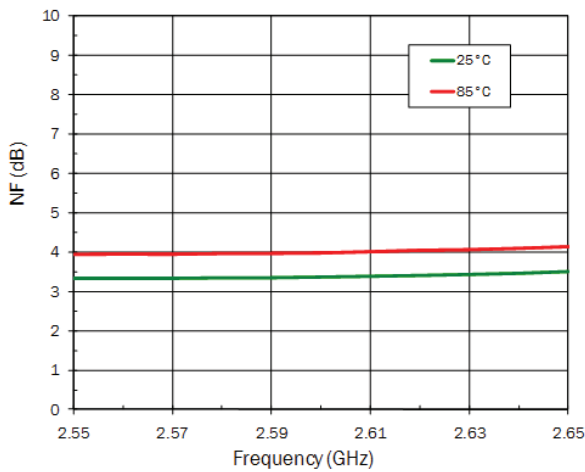

P1dB versus Frequency

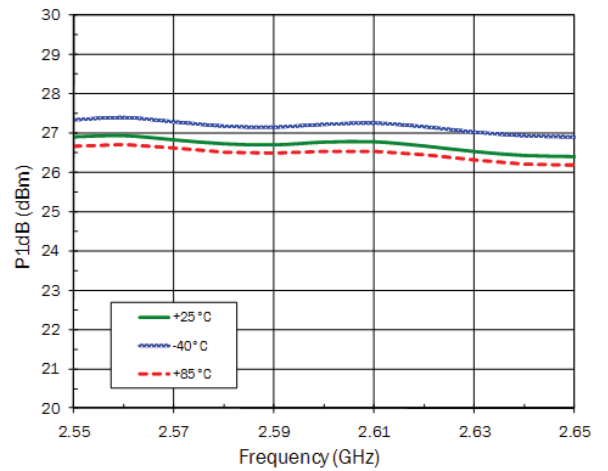

Typical Performance: 2550MHz to 2650MHz Application Circuit

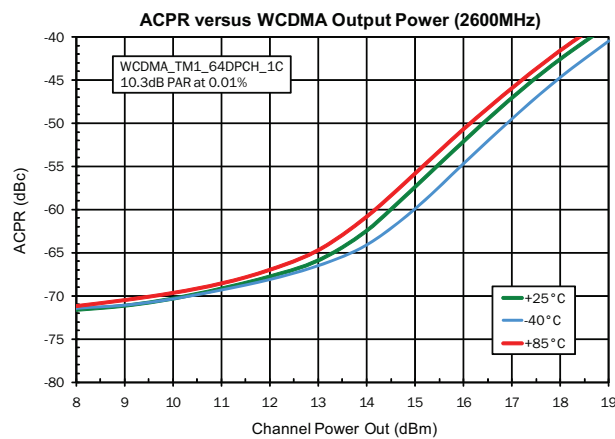
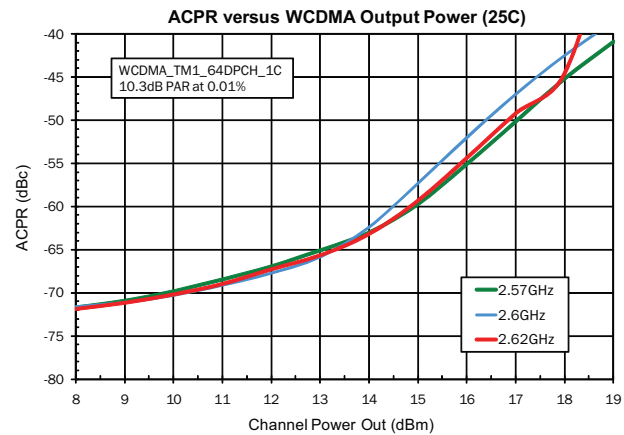
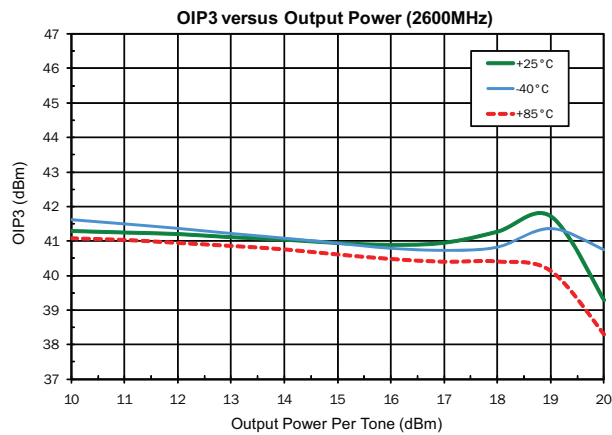
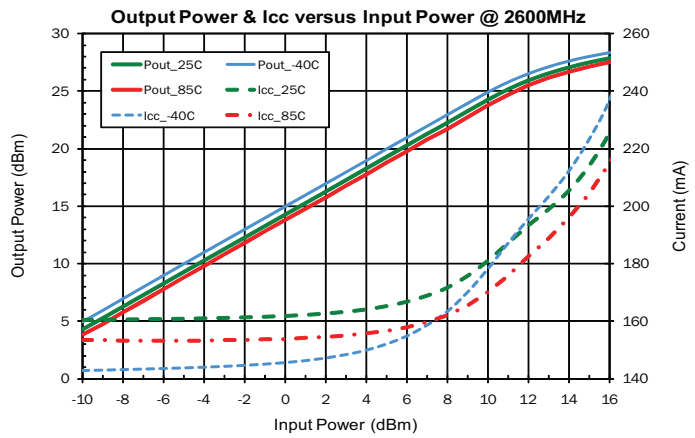
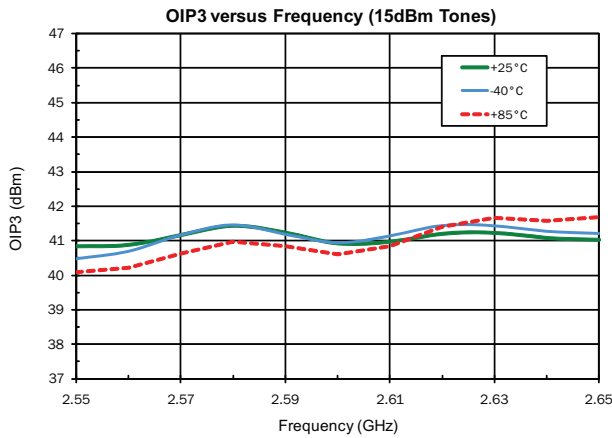

Evaluation Board Schematic
2550MHz to 2650MHz Application Circuit

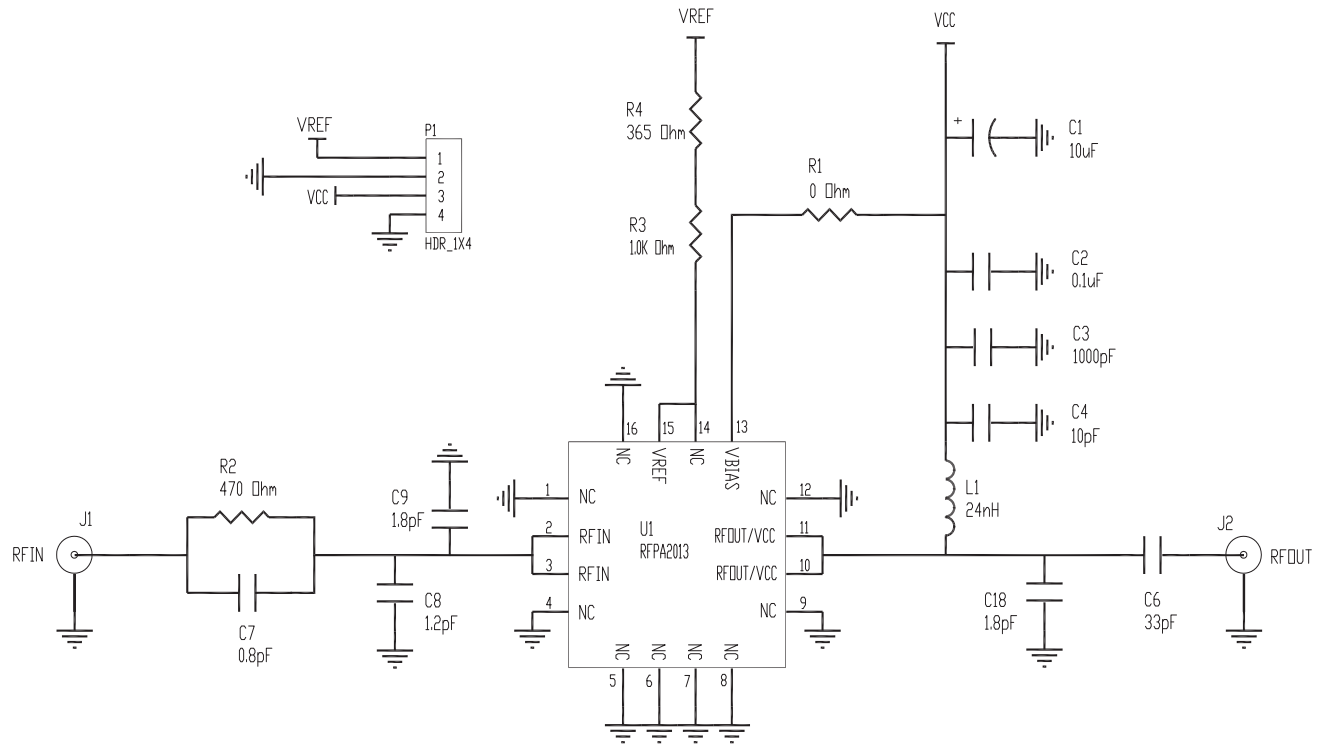

Evaluation Board Bill of Materials (BOM)
2550MHz to 2650MHz Application Circuit

Description	Reference Designator	Manufacturer	Manufacturer's P/N
Evaluation Board		DDI	PA2013410(B)
GaAs HBT Power Amplifier	U1	RFMD	RFPA2013
CAP, 10μF, 20%, 10V, TANT-A	C1	Kemet	T491A106M010AT
CAP, 0.1μF, 10%, 16V, X7R, 0402	C2	Murata Electronics	GRM155R71C104KA88D
CAP, 1000pF, 10%, 50V, X7R, 0402	C3	Murata Electronics	GRM155R71H102KA01D
CAP, 10pF, 5%, 50V, COG, 0402	C4	Murata Electronics	GRM1555C1H100JZ01E
CAP, 33pF, 5%, 50V, COG, 0402	C6	Murata Electronics	GRM1555C1H330JZ01E
CAP, 0.8pF, +/-0.1pF, 50V, HI-Q, 0402	C7	Johanson Technology	500R07S0R8BV4TD
CAP, 1.2pF, +/-0.1pF, 50V, HI-Q, 0402	C8	Johanson Technology	500R07S1R2BV4TD
CAP, 1.8pF, +/-0.1pF, 50V, HI-Q, 0402	C9, C18	Johanson Technology	500R07S1R8BV4TD
CONN, SMA, END LNCH, MINI, FLT, 0.068"	J1-J2	Emerson Networks	142-0741-851
IND, 24nH, 5%, W/W, 0603	L1	Coilcraft, Inc.	0603HC-24NXJLW
CONN, HDR, ST, PLRZD, 4-PIN, 0.100"	P1	ITW Pancon	MPSS100-4-C
RES, 0Ω, 0402	R1	Kamaya, Inc	RMC1/16SJPTH
RES, 470Ω, 5%, 1/16W, 0402	R2	Kamaya, Inc	RMC1/16S-471JTH
RES, 1K, 5%, 1/16W, 0402	R3	Kamaya, Inc	RMC1/16S-102JTH
RES, 365Ω, 1%, 1/16W, 0402	R4	Panasonic Industrial Co.	ERJ-2RKF3650X
DO NOT PLACE (DNP)	C5, C10-C17, C19-C23, R5-R6		

Typical Performance: 2600MHz to 2700MHz Application Circuit

S11 versus Frequency

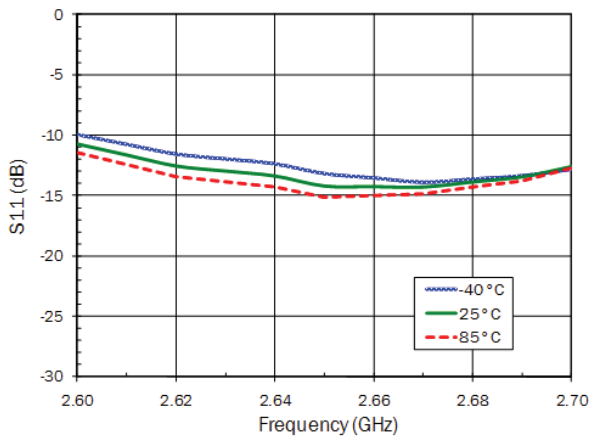

S21 versus Frequency

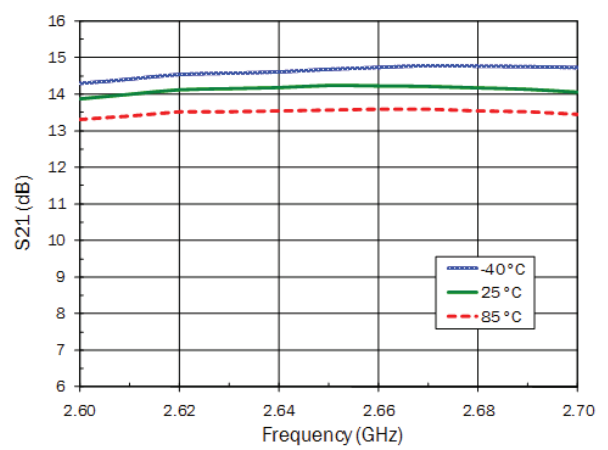

S12 versus Frequency

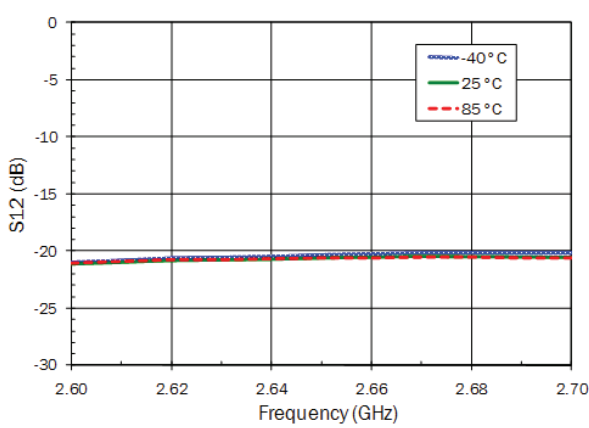

S22 versus Frequency

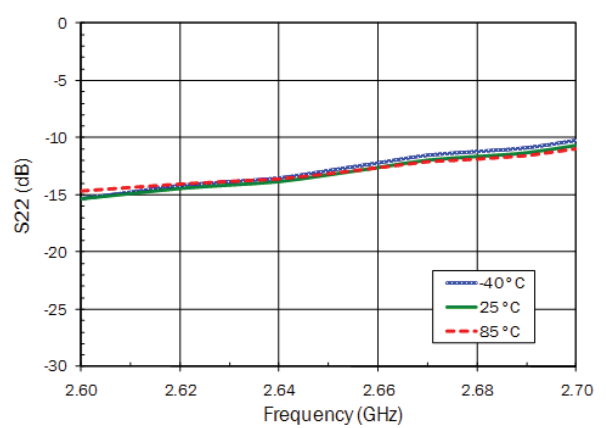

Noise Figure versus Frequency

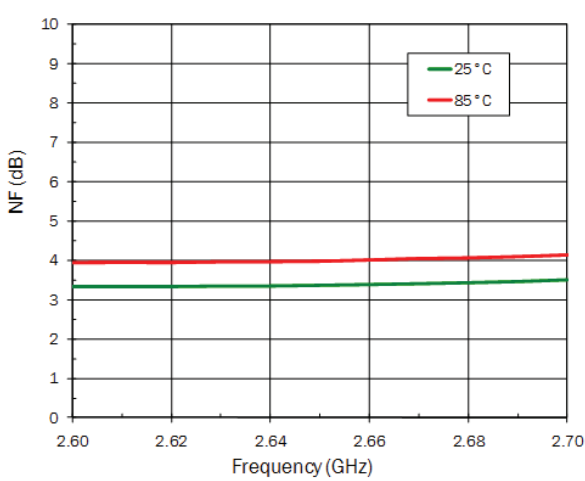

P1dB versus Frequency

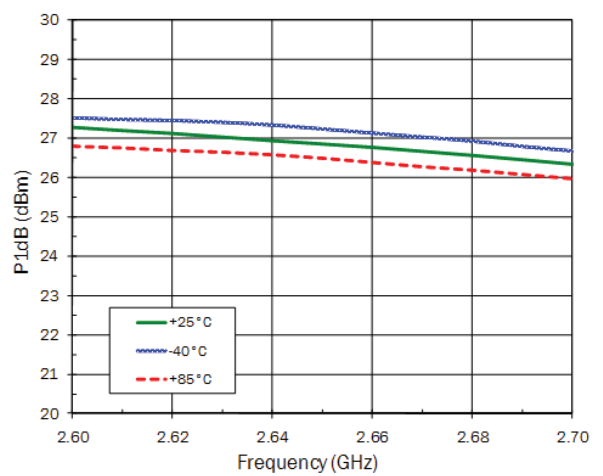

Typical Performance: 2600MHz to 2700MHz Application Circuit

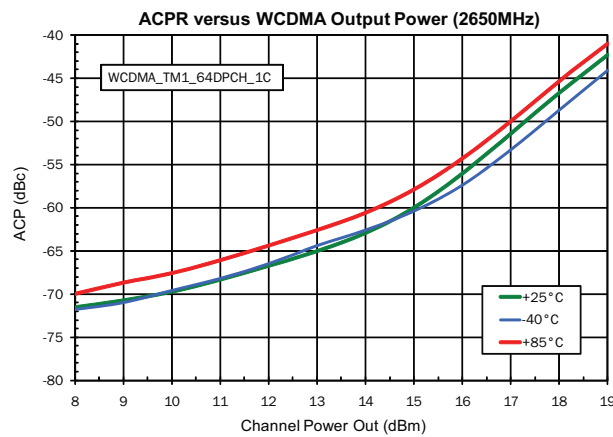
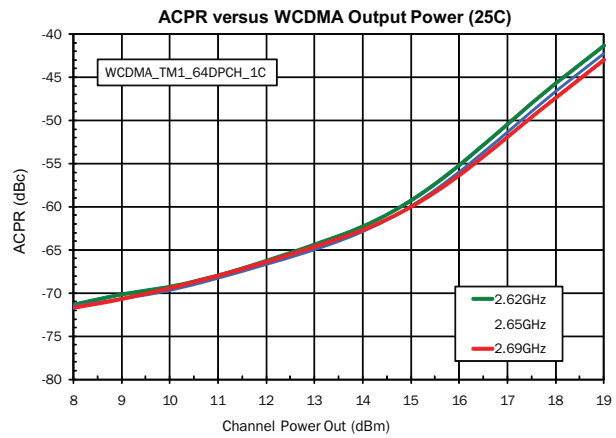
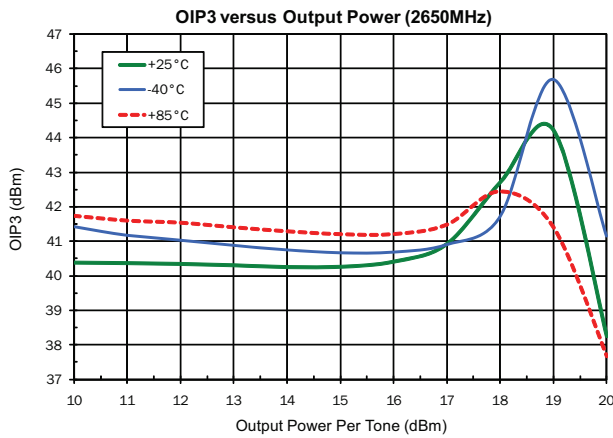
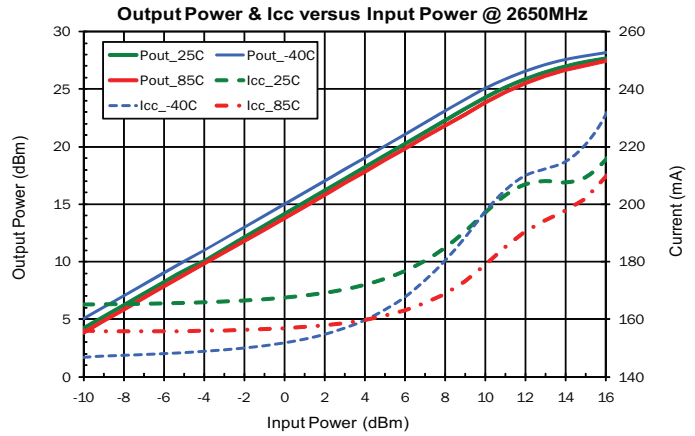
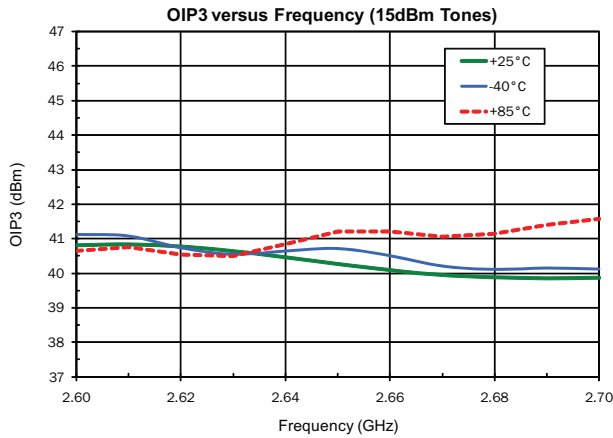

Evaluation Board Schematic 2600MHz to 2700MHz Application Circuit

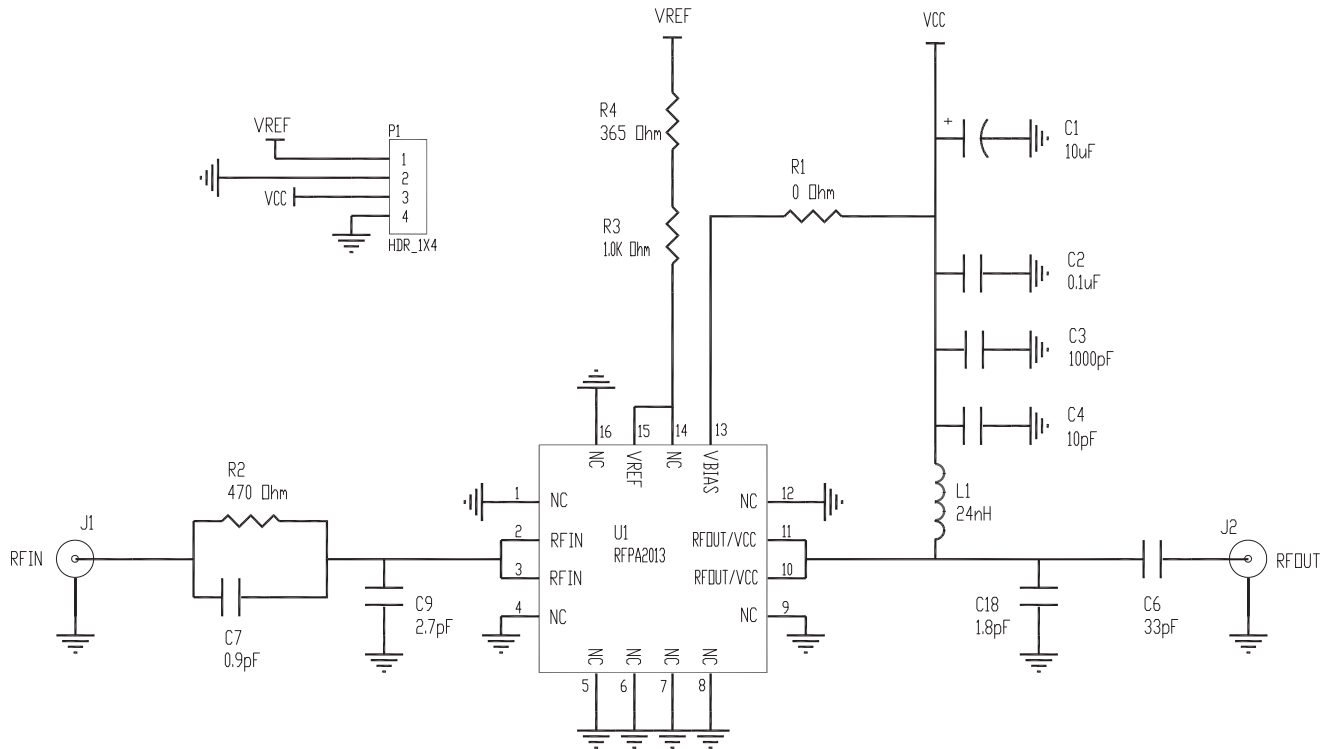

Evaluation Board Bill of Materials (BOM) 2600MHz to 2700MHz Application Circuit

Description	Reference Designator	Manufacturer	Manufacturer's P/N
Evaluation Board		DDI	PA2013410(B)
GaAs HBT Power Amplifier	U1	RFMD	RFPA2013
CAP, 10μF, 20%, 10V, TANT-A	C1	Kemet	T491A106M010AT
CAP, 0.1μF, 10%, 16V, X7R, 0402	C2	Murata Electronics	GRM155R71C104KA88D
CAP, 1000pF, 10%, 50V, X7R, 0402	C3	Murata Electronics	GRM155R71H102KA01D
CAP, 10pF, 5%, 50V, COG, 0402	C4	Murata Electronics	GRM1555C1H100JZ01E
CAP, 1.8pF, +/-0.1PF, 50V, HI-Q, 0402	C18	Johanson Technology	500R07S1R8BV4TD
CAP, 33pF, 5%, 50V, COG, 0402	C6	Murata Electronics	GRM1555C1H330JZ01E
CAP, 0.9pF, +/-0.1pF, 50V, HI-Q, 0402	C7	Johanson Technology	500R07S0R9BV4TD
CAP, 2.7pF, +/-0.1pF, 50V, HI-Q, 0402	C9	Johanson Technology	500R07S2R7BV4TD
CONN, SMA, END LNCH, MINI, FLT, 0.068"	J1-J2	Emerson Networks	142-0741-851
IND, 24nH, 5%, W/W, 0603	L1	Coilcraft, Inc.	0603HC-24NXJLW
CONN, HDR, ST, PLRZD, 4-PIN, 0.100"	P1	ITW Pancon	MPSS100-4-C
RES, 0Ω, 0402	R1	Kamaya, Inc	RMC1/16SJPTH
RES, 470Ω, 5%, 1/16W, 0402	R2	Kamaya, Inc	RMC1/16S-471JTH
RES, 1K, 5%, 1/16W, 0402	R3	Kamaya, Inc	RMC1/16S-102JTH
RES, 365Ω, 1%, 1/16W, 0402	R4	Panasonic Industrial Co.	ERJ-2RKF3650X
DO NOT PLACE (DNP)	C5, C8, C10-C17, C19-C23, R5-R6		

Evaluation Board Assembly Drawing
For 2140MHz, 2600MHz, 2650MHz Application Circuits

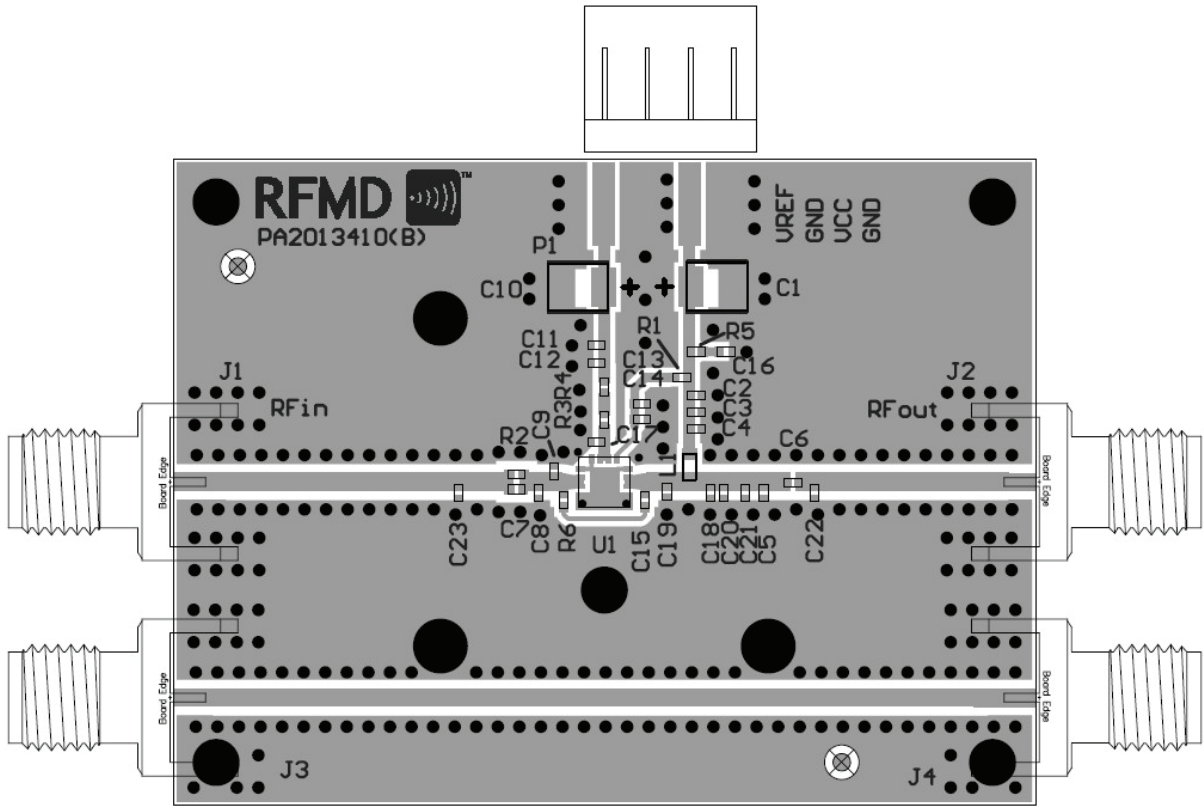

Note: See schematic and BOM for band-specific component requirements. Many components in the drawing above are Do-Not-Place.

Pin Names and Description

Pin	Function	Description
1	NC	No internal connection. EVB can be ground or no connect.
2	RFIN	RF input. External DC block is required.
3	RFIN	RF input. External DC block is required.
4	NC	No internal connection. EVB can be ground or no connect.
5	NC	No internal connection. EVB can be ground or no connect.
6	NC	No internal connection. EVB can be ground or no connect.
7	NC	No internal connection. EVB can be ground or no connect.
8	NC	No internal connection. EVB can be ground or no connect.
9	NC	No internal connection. EVB can be ground or no connect.
10	RFOUT/VCC	RF output and collector bias
11	RFOUT/VCC	RF output and collector bias
12	NC	No internal connection. EVB can be ground or no connect.
13	VBIAS	Supply voltage for the active bias circuit
14	NC	No internal connection. EVB can be ground or no connect.
15	VREF	Bias control pin. Can also be used as a power-down pin.
16	NC	No internal connection. EVB can be ground or no connect.
EPAD	GND	DC and RF ground. Must be soldered to EVB ground plane over a bed of vias for thermal and RF performance. Solder/epoxy voids under the EPAD will result in excessive junction temperatures causing permanent damage.

Pin Out

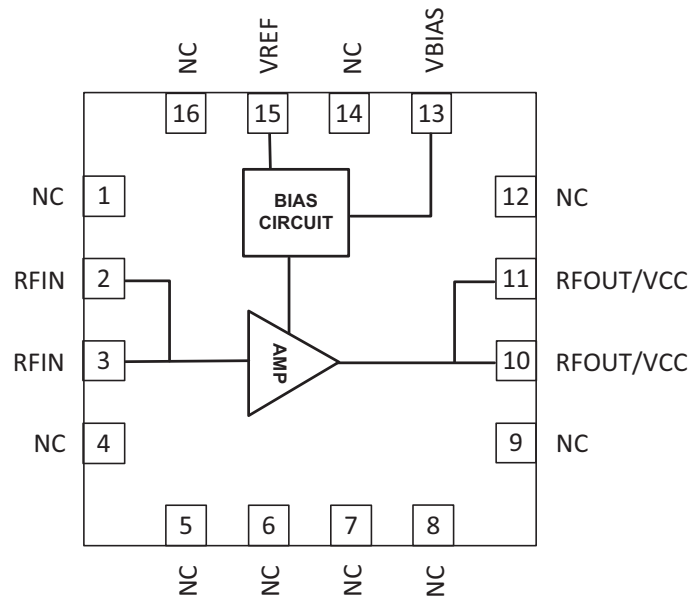

Package Drawing

Dimensions in millimeters [inches]
 Refer to drawing posted at www.rfmd.com for tolerances.

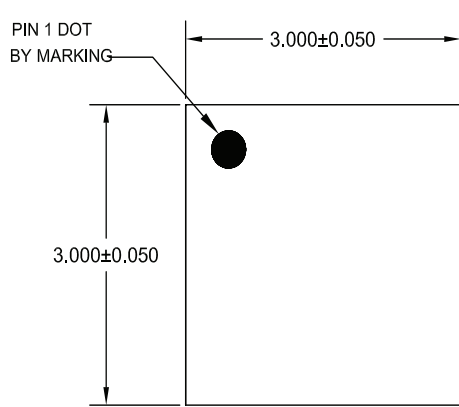

TOP VIEW

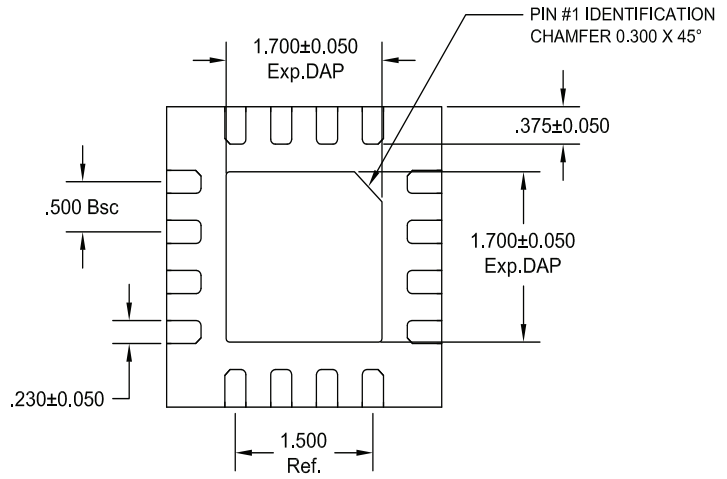

BOTTOM VIEW

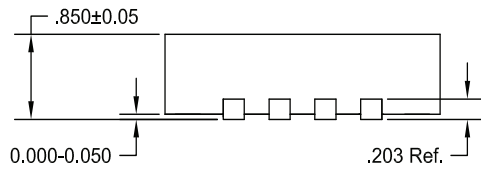

TOP VIEW

Branding Diagram

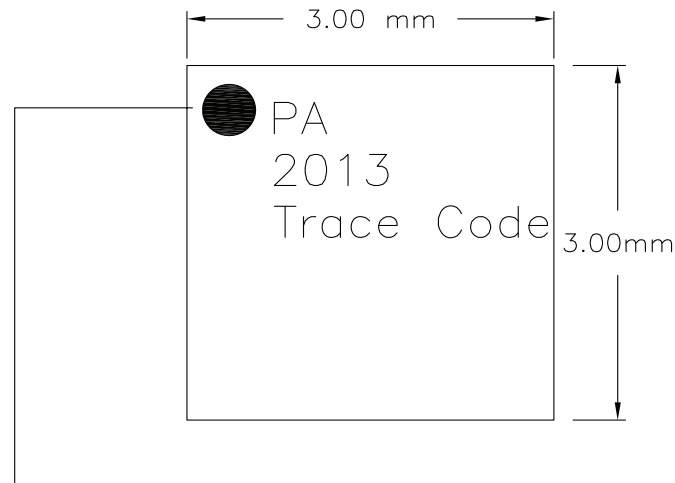

Pin 1 Indicator

Trace Code to be assigned by SubCon