

SD Series 450W Discrete Unidirectional TVS Diode **AUTOMOTIVE GRADE** **RoHS** **Pb** **GREEN**



Description

The SD series is designed to replace multilayer varistors (MLVs) in electronic equipment for low speed and DC applications. It will protect any sensitive equipment from damage due to electrostatic discharge (ESD) and other transient events.

The SD series can safely absorb repetitive ESD strikes at $\pm 30\text{kV}$ (contact discharge, IEC 61000-4-2) without performance degradation and safely dissipate 30A (SD05) of 8/20 μs induced surge current (IEC61000-4-5) with very low clamping voltages.

Pinout and Functional Block Diagram

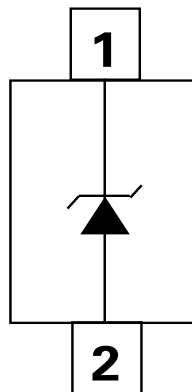

Features

- ESD, IEC61000-4-2, $\pm 30\text{kV}$ contact, $\pm 30\text{kV}$ air
- EFT, IEC61000-4-4, 40A (5/50ns)
- Lightning, IEC61000-4-5, 30A ($t_p=8/20\mu\text{s}$, SD05)
- Low clamping voltage
- Low leakage current
- Small SOD323 package fits 0805 footprints
- AEC-Q101 qualified

Applications

- Switches / Buttons
- Test Equipment / Instrumentation
- Point-of-Sale Terminals
- Medical Equipment
- Notebooks / Desktops / Servers
- Computer Peripherals
- Automotive Electronics

Life Support Note:

Not Intended for Use in Life Support or Life Saving Applications

The products shown herein are not designed for use in life sustaining or life saving applications unless otherwise expressly indicated.

Absolute Maximum Ratings

Symbol	Parameter	Value	Units
P_{pk}	Peak Pulse Power ($t_p=8/20\mu s$)	450	W
T_{OP}	Operating Temperature	-40 to 125	°C
T_{STOR}	Storage Temperature	-55 to 150	°C

Notes:

CAUTION: Stresses above those listed in "Absolute Maximum Ratings" may cause permanent damage to the device. This is a stress only rating and operation of the device at these or any other conditions above those indicated in the operational sections of this specification is not implied.

Thermal Information

Parameter	Rating	Units
Storage Temperature Range	-55 to 150	°C
Maximum Junction Temperature	150	°C
Maximum Lead Temperature (Soldering 20-40s)	260	°C

SD05 Electrical Characteristics ($T_{OP}=25^\circ C$)

Parameter	Symbol	Test Conditions	Min	Typ	Max	Units
Reverse Standoff Voltage	V_{RWM}	$I_R \leq 1\mu A$			5.0	V
Reverse Voltage Drop	V_R	$I_R = 1mA$	6.0			V
Leakage Current	I_{LEAK}	$V_R = 5V$			1.0	μA
Clamp Voltage ¹	V_C	$I_{PP} = 1A, t_p = 8/20\mu s, Fwd$			9.8	V
		$I_{PP} = 10A, t_p = 8/20\mu s, Fwd$			13.0	V
Dynamic Resistance ²	R_{DYN}	TLP, $t_p = 100ns$, I/O to Ground		0.22		Ω
Peak Pulse Current	I_{PP}	$t_p = 8/20\mu s$			30.0	A
ESD Withstand Voltage ¹	V_{ESD}	IEC61000-4-2 (Contact Discharge)	± 30			kV
		IEC61000-4-2 (Air Discharge)	± 30			kV
Diode Capacitance ¹	C_D	Reverse Bias=0V, f=1MHz			350	pF

SD12 Electrical Characteristics ($T_{OP}=25^\circ C$)

Parameter	Symbol	Test Conditions	Min	Typ	Max	Units
Reverse Standoff Voltage	V_{RWM}	$I_R \leq 1\mu A$			12.0	V
Reverse Voltage Drop	V_R	$I_R = 1mA$	13.3			V
Leakage Current	I_{LEAK}	$V_R = 12V$			1.0	μA
Clamp Voltage ¹	V_C	$I_{PP} = 1A, t_p = 8/20\mu s, Fwd$			18.5	V
		$I_{PP} = 10A, t_p = 8/20\mu s, Fwd$			22.5	V
Dynamic Resistance ²	R_{DYN}	TLP, $t_p = 100ns$, I/O to Ground		0.29		Ω
Peak Pulse Current	I_{PP}	$t_p = 8/20\mu s$			17.0	A
ESD Withstand Voltage ¹	V_{ESD}	IEC61000-4-2 (Contact Discharge)	± 30			kV
		IEC61000-4-2 (Air Discharge)	± 30			kV
Diode Capacitance ¹	C_{D-GND}	Reverse Bias=0V, f=1MHz			150	pF

SD15 Electrical Characteristics (T_{Op}=25°C)

Parameter	Symbol	Test Conditions	Min	Typ	Max	Units
Reverse Standoff Voltage	V _{RWM}	I _R ≤ 1 μA			15.0	V
Reverse Voltage Drop	V _R	I _R = 1 mA	16.7			V
Leakage Current	I _{LEAK}	V _R = 15V			1.0	μA
Clamp Voltage ¹	V _C	I _{PP} = 1A, t _p = 8/20 μs, Fwd			24.0	V
		I _{PP} = 10A, t _p = 8/20 μs, Fwd			30.0	V
Dynamic Resistance ²	R _{DYN}	TLP, tp = 100ns, I/O to Ground		0.34		Ω
Peak Pulse Current	I _{PP}	t _p = 8/20 μs			12.0	A
ESD Withstand Voltage ¹	V _{ESD}	IEC61000-4-2 (Contact Discharge)	±30			kV
		IEC61000-4-2 (Air Discharge)	±30			kV
Diode Capacitance ¹	C _{I/O-GND}	Reverse Bias = 0V, f = 1MHz			100	pF

SD24 Electrical Characteristics (T_{Op}=25°C)

Parameter	Symbol	Test Conditions	Min	Typ	Max	Units
Reverse Standoff Voltage	V _{RWM}	I _R ≤ 1 μA			24.0	V
Reverse Voltage Drop	V _R	I _R = 1 mA	26.7			V
Leakage Current	I _{LEAK}	V _R = 24V			1.0	μA
Clamp Voltage ¹	V _C	I _{PP} = 1A, t _p = 8/20 μs, Fwd			36.0	V
		I _{PP} = 5A, t _p = 8/20 μs, Fwd			42.0	V
Dynamic Resistance ²	R _{DYN}	TLP, tp = 100ns, I/O to Ground		0.49		Ω
Peak Pulse Current	I _{PP}	t _p = 8/20 μs			7.0	A
ESD Withstand Voltage ¹	V _{ESD}	IEC61000-4-2 (Contact Discharge)	±30			kV
		IEC61000-4-2 (Air Discharge)	±30			kV
Diode Capacitance ¹	C _{I/O-GND}	Reverse Bias = 0V, f = 1MHz			65	pF

SD36 Electrical Characteristics (T_{Op}=25°C)

Parameter	Symbol	Test Conditions	Min	Typ	Max	Units
Reverse Standoff Voltage	V _{RWM}	I _R ≤ 1 μA			36.0	V
Reverse Voltage Drop	V _R	I _R = 1 mA	40.0			V
Leakage Current	I _{LEAK}	V _R = 36V			1.0	μA
Clamp Voltage ¹	V _C	I _{PP} = 1A, t _p = 8/20 μs, Fwd			52.0	V
		I _{PP} = 4A, t _p = 8/20 μs, Fwd			62.0	V
Dynamic Resistance ²	R _{DYN}	TLP, tp = 100ns, I/O to Ground		0.61		Ω
Peak Pulse Current	I _{PP}	t _p = 8/20 μs			5.0	A
ESD Withstand Voltage ¹	V _{ESD}	IEC61000-4-2 (Contact Discharge)	±30			kV
		IEC61000-4-2 (Air Discharge)	±30			kV
Diode Capacitance ¹	C _{I/O-GND}	Reverse Bias = 0V, f = 1MHz			50	pF

Note:

- Parameter is guaranteed by design and/or device characterization.
- Transmission Line Pulse (TLP) with 100ns width and 200ps rise time.

Non-Repetitive Peak Pulse Power vs. Pulse Time

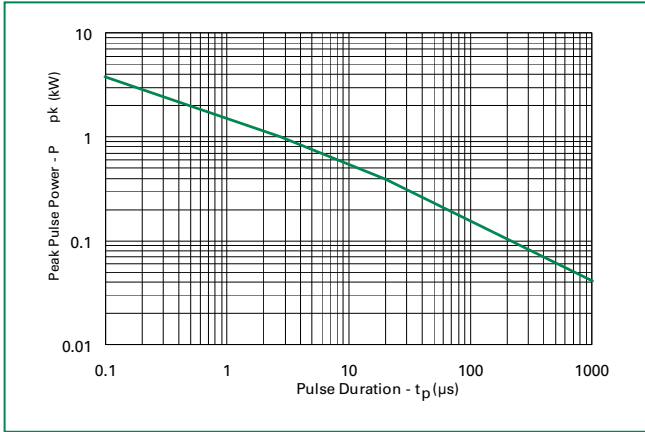

Capacitance vs. Bias

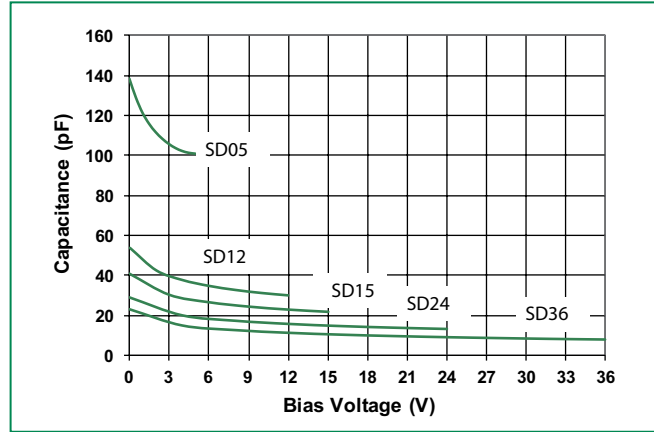

Power Derating Curve

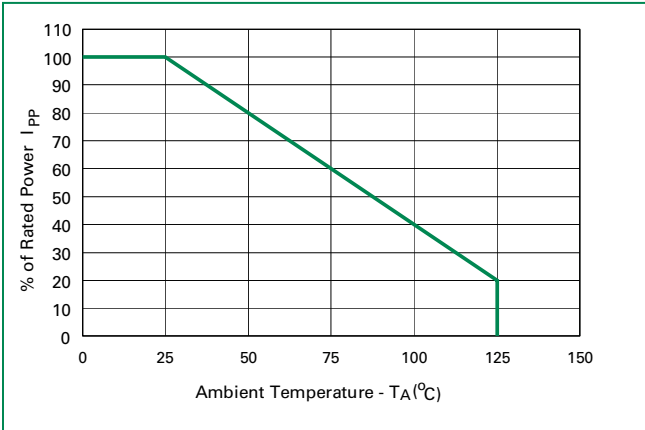

Pulse Waveform

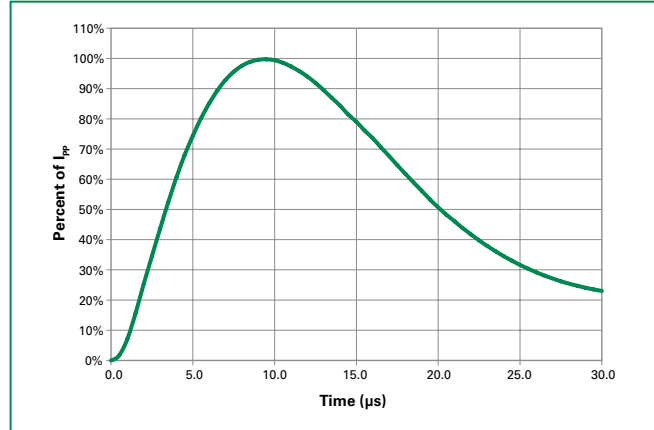

SD05 Transmission Line Pulsing(TLP) Plot

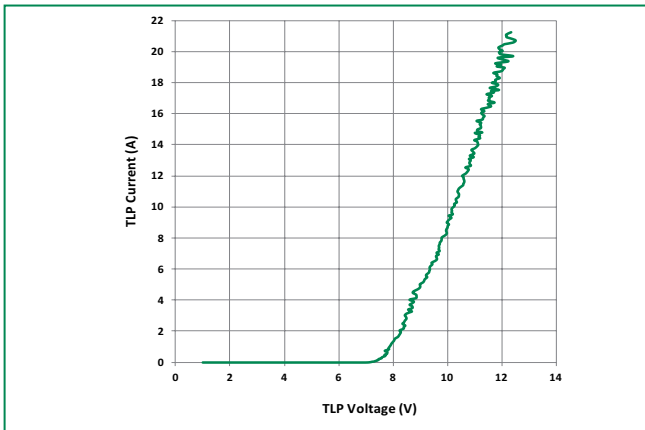

SD12 Transmission Line Pulsing(TLP) Plot

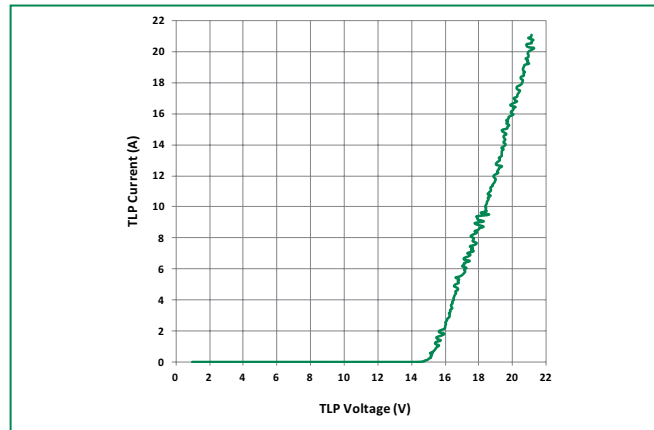

SD15 Transmission Line Pulsing(TLP) Plot

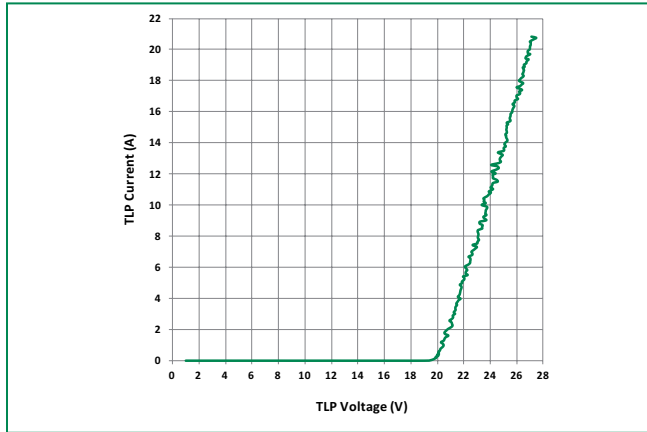

SD24 Transmission Line Pulsing(TLP) Plot

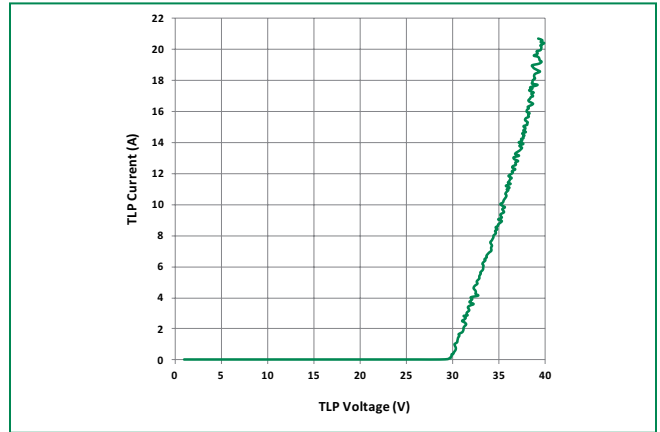

SD36 Transmission Line Pulsing(TLP) Plot

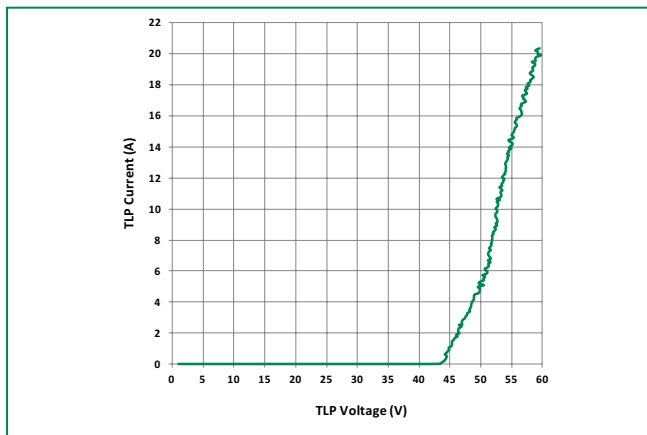

Soldering Parameters

Reflow Condition		Pb – Free assembly
Pre Heat	- Temperature Min ($T_{s(min)}$)	150°C
	- Temperature Max ($T_{s(max)}$)	200°C
	- Time (min to max) (t_s)	60 – 180 secs
Average ramp up rate (Liquidus) Temp (T_L) to peak		3°C/second max
$T_{s(max)}$ to T_L - Ramp-up Rate		3°C/second max
Reflow	- Temperature (T_L) (Liquidus)	217°C
	- Temperature (t_L)	60 – 150 seconds
Peak Temperature (T_p)		260 ^{+0/-5} °C
Time within 5°C of actual peak Temperature (t_p)		20 – 40 seconds
Ramp-down Rate		6°C/second max
Time 25°C to peak Temperature (T_p)		8 minutes Max.
Do not exceed		260°C

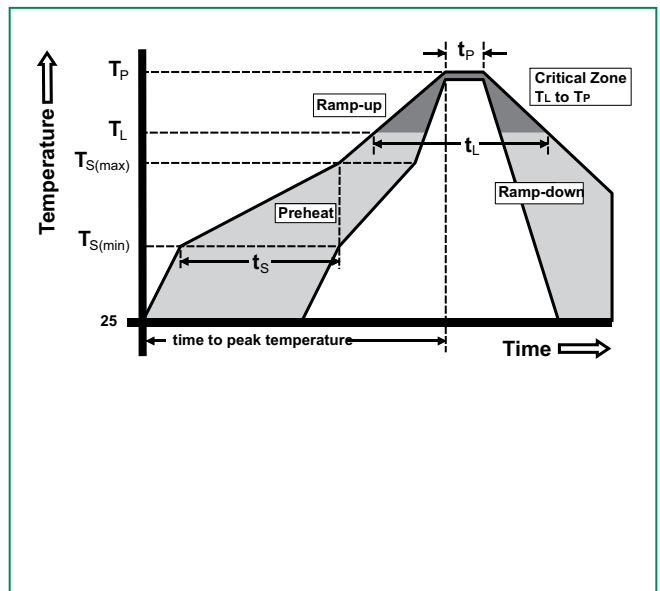

Product Characteristics

Lead Plating	Matte Tin
Lead Material	Copper Alloy
Lead Coplanarity	0.0004 inches (0.102mm)
Substrate material	Silicon
Body Material	Molded Epoxy
Flammability	UL 94 V-0

- Notes :
1. All dimensions are in millimeters
 2. Dimensions include solder plating.
 3. Dimensions are exclusive of mold flash & metal burr.
 4. Blo is facing up for mold and facing down for trim/form, i.e. reverse trim/form.
 5. Package surface matte finish VDI 11-13.

Ordering Information

Part Number	Package	Marking	Min. Order Qty.
SD05-01FTG	SOD323	g	3000
SD12-01FTG	SOD323	g1	3000
SD15-01FTG	SOD323	g2	3000
SD24-01FTG	SOD323	g3	3000
SD36-01FTG	SOD323	g4	3000

Part Marking System

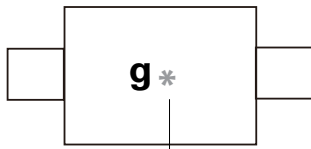

Blank: SD05-01FTG
 1: SD12-01FTG
 2: SD15-01FTG
 3: SD24-01FTG
 4: SD36-01FTG

Part Numbering System

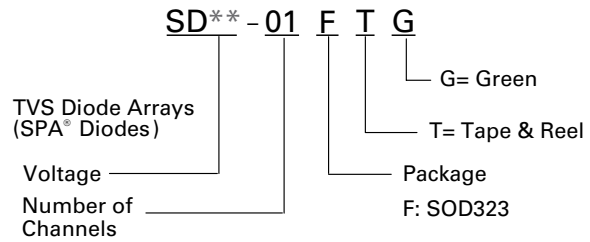

Package Dimensions -SOD323

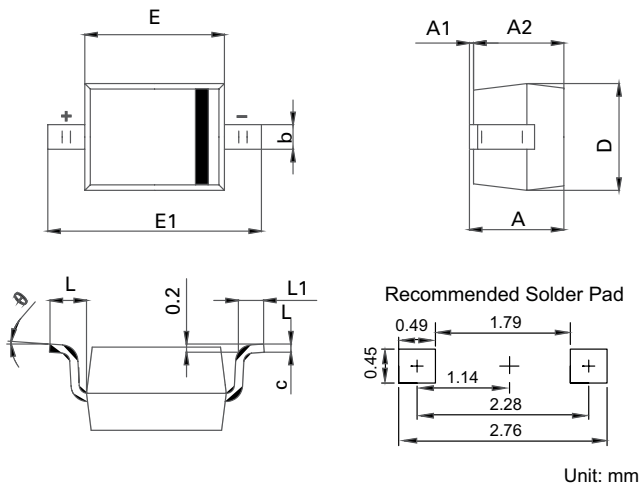

Symbol	SOD323			
	Millimeters		Inches	
	Min	Max	Min	Max
A		1.00		0.039
A1	0.00	0.10	0.000	0.004
A2	0.80	0.90	0.031	0.035
b	0.25	0.35	0.010	0.014
c	0.08	0.15	0.003	0.006
D	1.20	1.40	0.047	0.055
E	1.60	1.80	0.063	0.071
E1	2.50	2.70	0.098	0.106
L	0.475 REF		0.019 REF	
L1	0.25	0.40	0.010	0.016
Ø	0°	8°	0°	8°

Embossed Carrier Tape & Reel Specification – SOD323

