

DETAILS

Product Number	F13381_ANGELA-W
Family	ANGELA
Type	Reflector
Color	metal
Diameter	119.5 mm
Height	74.5 mm
Style	round
Optic Material	PC
Holder Material	
Fastening	
Status	ready
ROHS Compliant	Yes
Date Updated	13/06/2014



OPTICAL PROPERTIES

LED	Viewing Angle	Light Beam	Efficiency	cd/lm	connector
PrevaLED Core Z3 LES9	(simulated) 30		(simulated) 90 %	(simulated) 2.700	Z50 Optic Clip part n r. 2213194-1 TE
PrevaLED Core Z3 LES19	(simulated) 36		(simulated) 95 %	(simulated) 2.200	Z50 Optic Clip part n r. 2213194-1 TE
PrevaLED Core Z3 LES23	(simulated) 38		(simulated) 89 %	(simulated) 1.800	Z50 Optic Clip part n r. 2213194-1 TE
PrevaLED Core AC (LEP-800)	29 degrees		84 %	1.880	Z50 Optic Clip part n r. 2213194-1 TE
LUXEON CoB 1204/1205	33 degrees		84 %	1.680	Solderless connector part nr. 2213130-2 + Z50
Optic Clip part nr. 2213194-1 TE	33 degrees		85 %	1.800	Solderless connector part nr. 2213401-2 + Z50
LUXEON CoB 1204/1205	34 degrees		84 %	1.660	Solderless connector part nr. 2213130-2 + Z50
Optic Clip part nr. 2213194-1 TE	34 degrees		84 %	1.660	TE: Solderless connector part nr 2213254-2 + Z50
PrevaLED Core AC (LEP-2000)	34 degrees		84 %	1.670	Z50 Optic Clip part n r. 2213194-1 TE
PrevaLED Core Z4 LES19	34 degrees		84 %	1.700	Z50 Optic Clip part n r. 2213194-1 TE
WU-M-484	35 degrees		83 %	1.570	Z50 Optic Clip part n r. 2213194-1 TE
Soleriq S19	35 degrees		84 %	1.610	Solderless connector part nr. 2213407-2 + Z50
Optic Clip part nr. 2213194-1 TE	35 degrees		85 %	1.610	Solderless connector part nr. 180580-0005 Molex



PRODUCT DATASHEET
ANGELA series
last update 11/7/2014

STARK SLE G3 LES19

36 degrees

84 %

1.560

Z50 Optic Clip part n



PRODUCT DATASHEET
ANGELA series
last update 11/7/2014

r. 2213194-1 TE



PRODUCT DATASHEET
ANGELA series
last update 11/7/2014

LC026B/LC040B

36 degrees

84 %

1.500

Solderless connector



PRODUCT DATASHEET
ANGELA series
last update 11/7/2014

Optic Clip part nr. 2213194-1 TE

part nr. 2213258-2 + Z50



PRODUCT DATASHEET
ANGELA series
last update 11/7/2014

WU-M-461

37 degrees

84 %

1.600

Z50 Optic Clip part n



PRODUCT DATASHEET
ANGELA series
last update 11/7/2014

r. 2213194-1 TE



PRODUCT DATASHEET
ANGELA series
last update 11/7/2014

WU-M-485

39 degrees

83 %

1.430

Z50 Optic Clip part n



PRODUCT DATASHEET
ANGELA series
last update 11/7/2014

r. 2213194-1 TE



PRODUCT DATASHEET
ANGELA series
last update 11/7/2014

WU-M-486

39 degrees

83 %

1.430

Z50 Optic Clip part n



PRODUCT DATASHEET
ANGELA series
last update 11/7/2014

r. 2213194-1 TE



PRODUCT DATASHEET
ANGELA series
last update 11/7/2014

WU-M-462

41 degrees

83 %

1.440

Z50 Optic Clip part n



PRODUCT DATASHEET
ANGELA series
last update 11/7/2014

r. 2213194-1 TE



PRODUCT DATASHEET
ANGELA series
last update 11/7/2014

WU-M-464

41 degrees

83 %

1.440

Z50 Optic Clip part n



PRODUCT DATASHEET
ANGELA series
last update 11/7/2014

r. 2213194-1 TE



PRODUCT DATASHEET
ANGELA series
last update 11/7/2014

CXA35 44 degrees 84 % 1.260 50-2303CR + Angela(50)



PRODUCT DATASHEET
ANGELA series
last update 11/7/2014

-2300AN) IDEAL

D

C

B

A

8
7
6
5
4
3
2
1

8
7
6
5
4
3
2
1

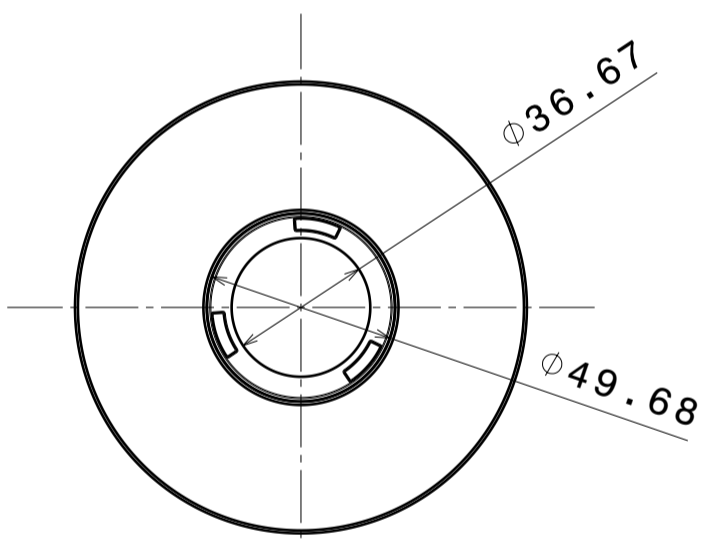
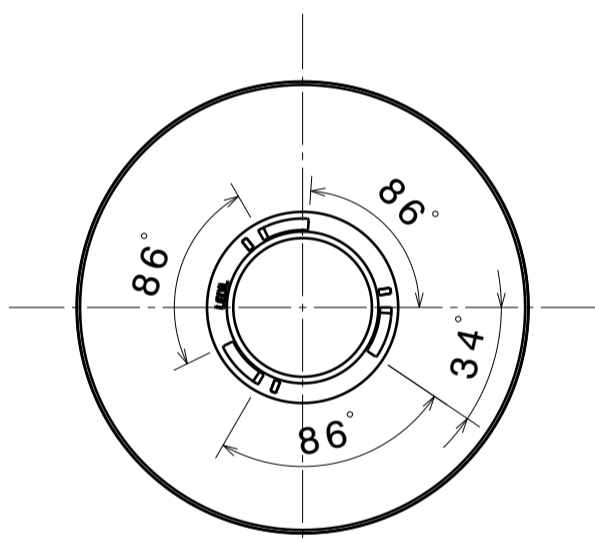
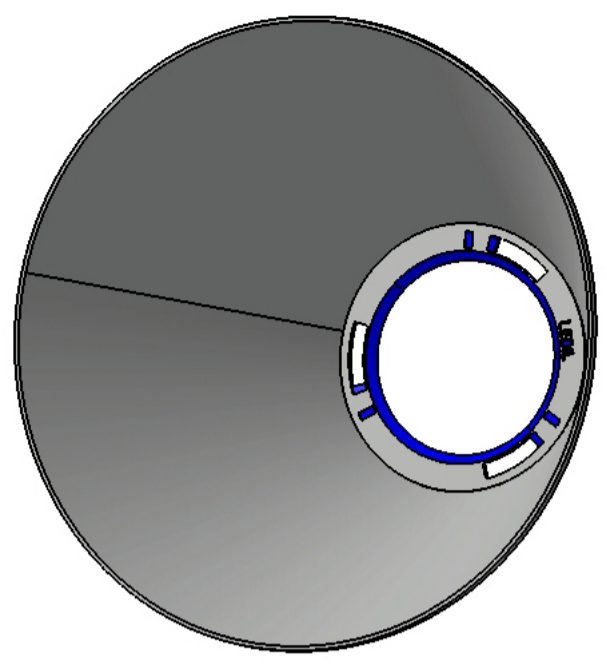
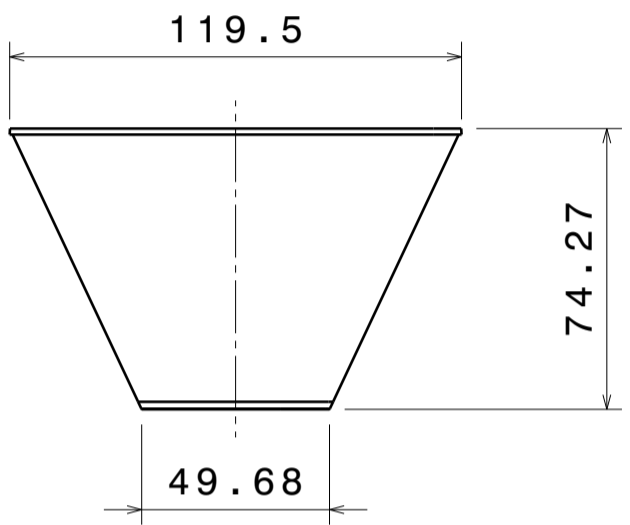

Tolerances if not otherwise shown
According to DIN ISO 2768-1
Linear measures:
Up to 30mm class F, otherwise class M.
According to DIN ISO 2768-2
Form and position: class K

THIRD ANGLE PROJECTION:

This drawing is the property
of LEDiL Oy. It may not be
reproduced, copied or
communicated without a written
agreement with LEDiL Oy."

LEDiL		LediL Oy Salorankatu 10 FIN 24240 SALO Finland	
DRAWING TITLE		ANGELA_Datasheet	
SIZE	PART NUMBER		
A3	-		
SCALE	1:1	WEIGHT	-
SHEET			1/1

D

A

Luminaire: LEDiL Oy F13381_ANGELA-W_(LEP-800-827-C-AC)

Lamps: 1 x OSRAM PrevaLED Core AC (LEP-800-827-C-AC) 910lm@60mA U:230V P:14W

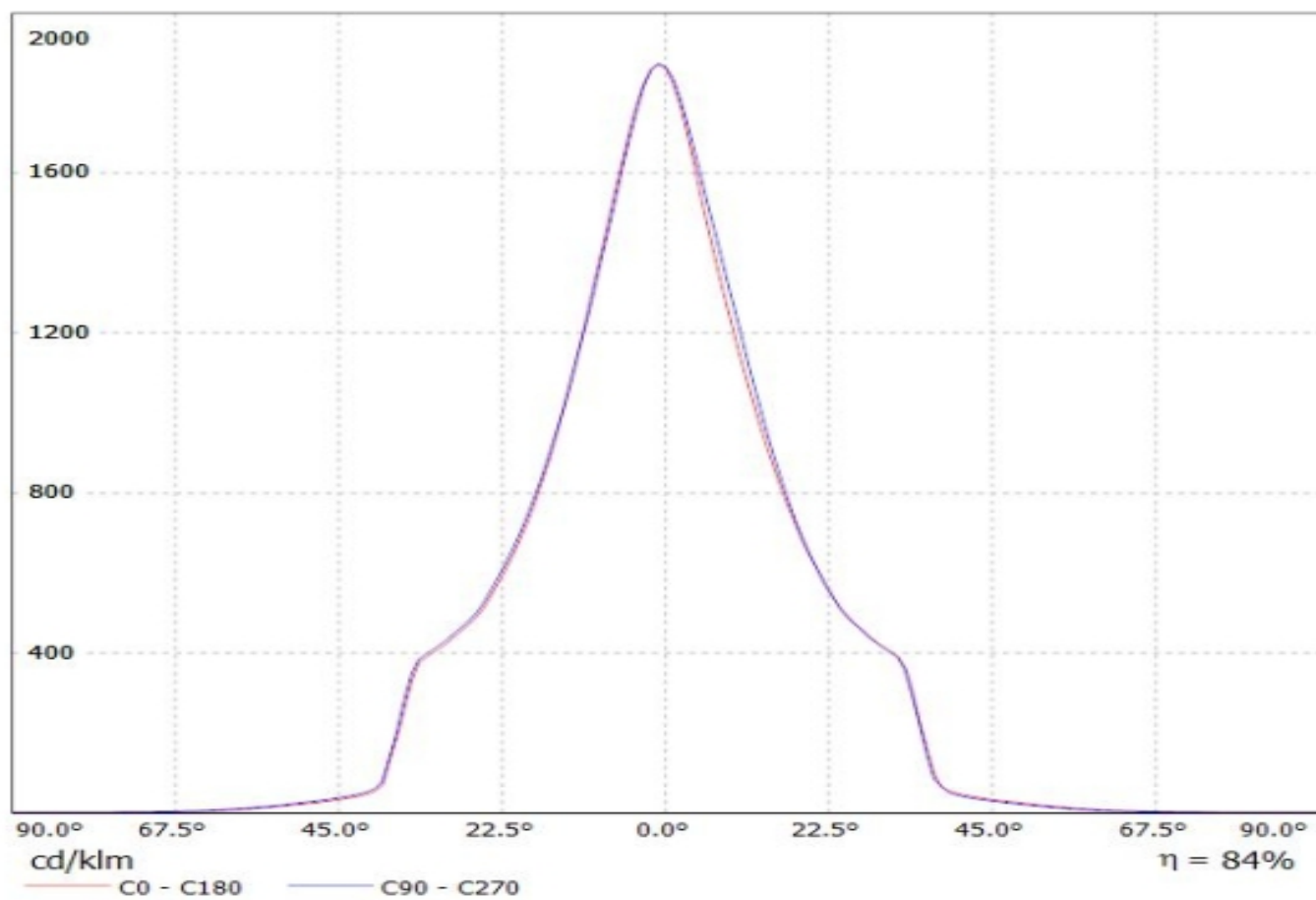

Luminaire: LEDiL Oy F13381_ANGELA-W_(COB_1205) Eff.83.8%
Lamps: 1 x Luxeon_COB_1205_1092.75lm@250mA_P=8.33092W_I=249.9mA

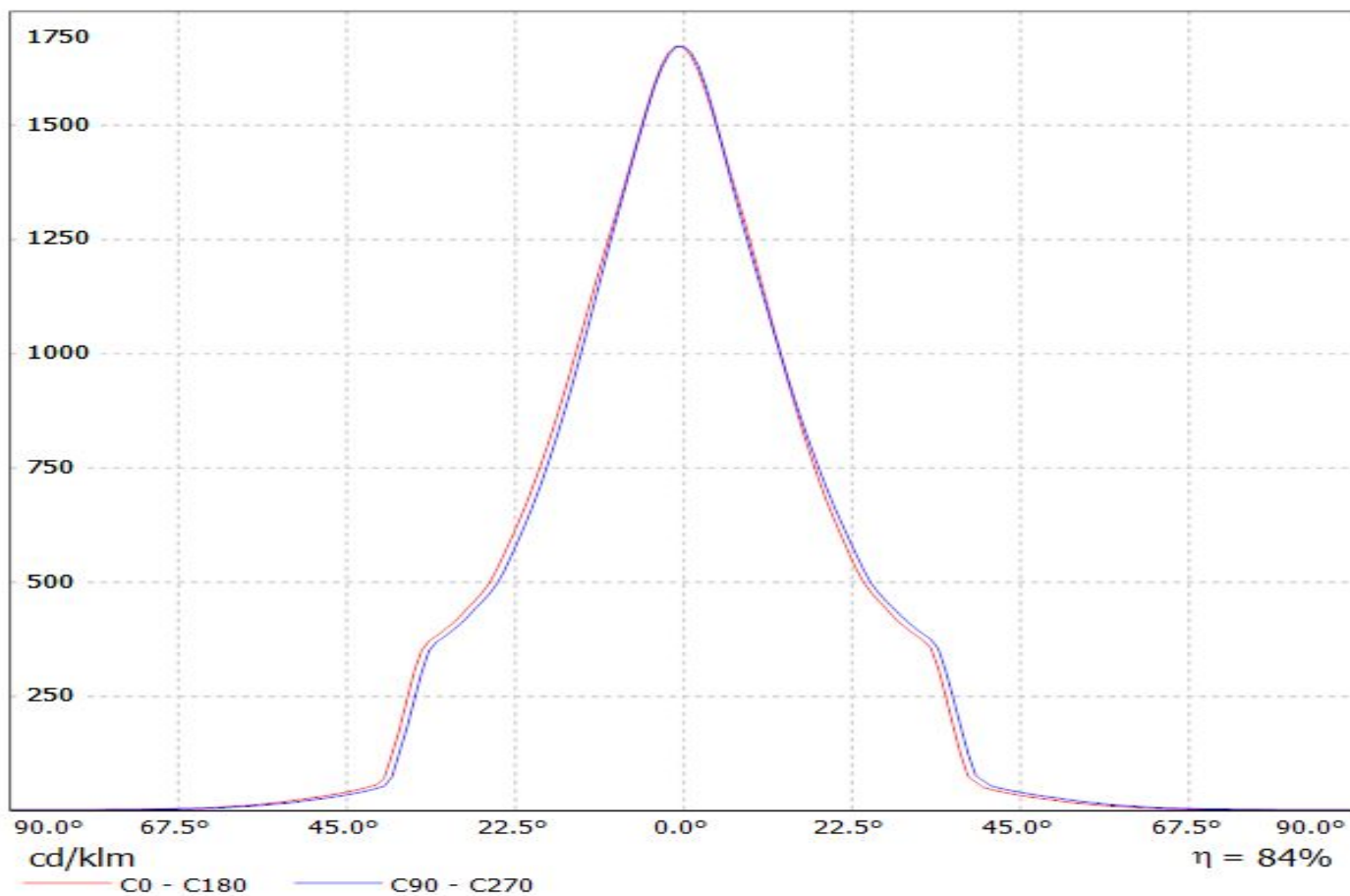

Luminaire: LEDil Oy F13381_ANGELA-W_(Soleriq_S13) Efficiency=85%
Lamps: 1 x Osram Soleriq S13 (GW KAGHB1.EM) 855lm @ 250mA CCT=3100K P=7.5W I=250mA

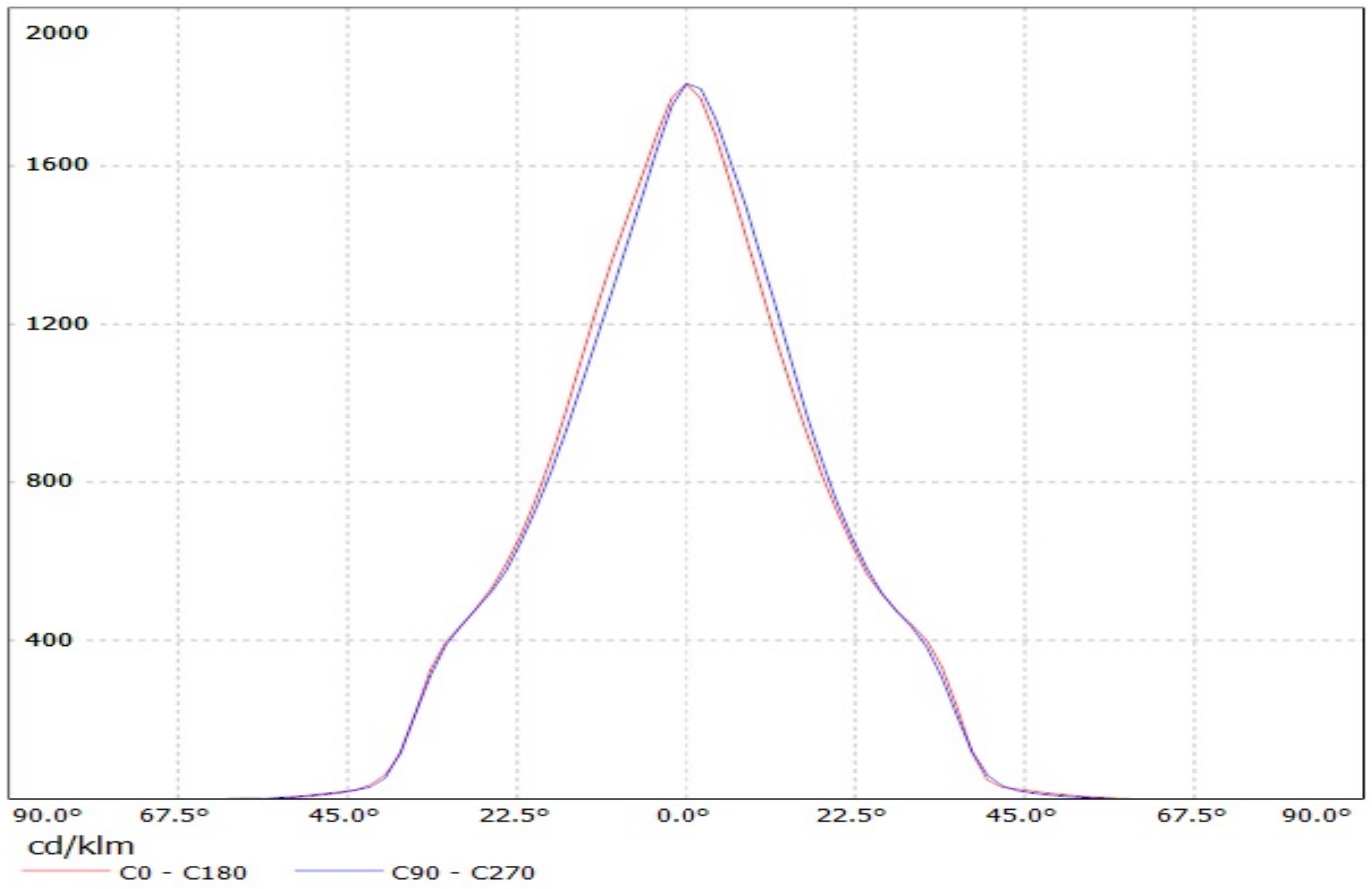

Luminaire: LEDiL Oy F13381_ANGELA-W_(COB_1208) Eff.83.8%
Lamps: 1 x Luxeon_COB_1208_1039.97lm@250mA_P=8.28793W_I=249.9mA

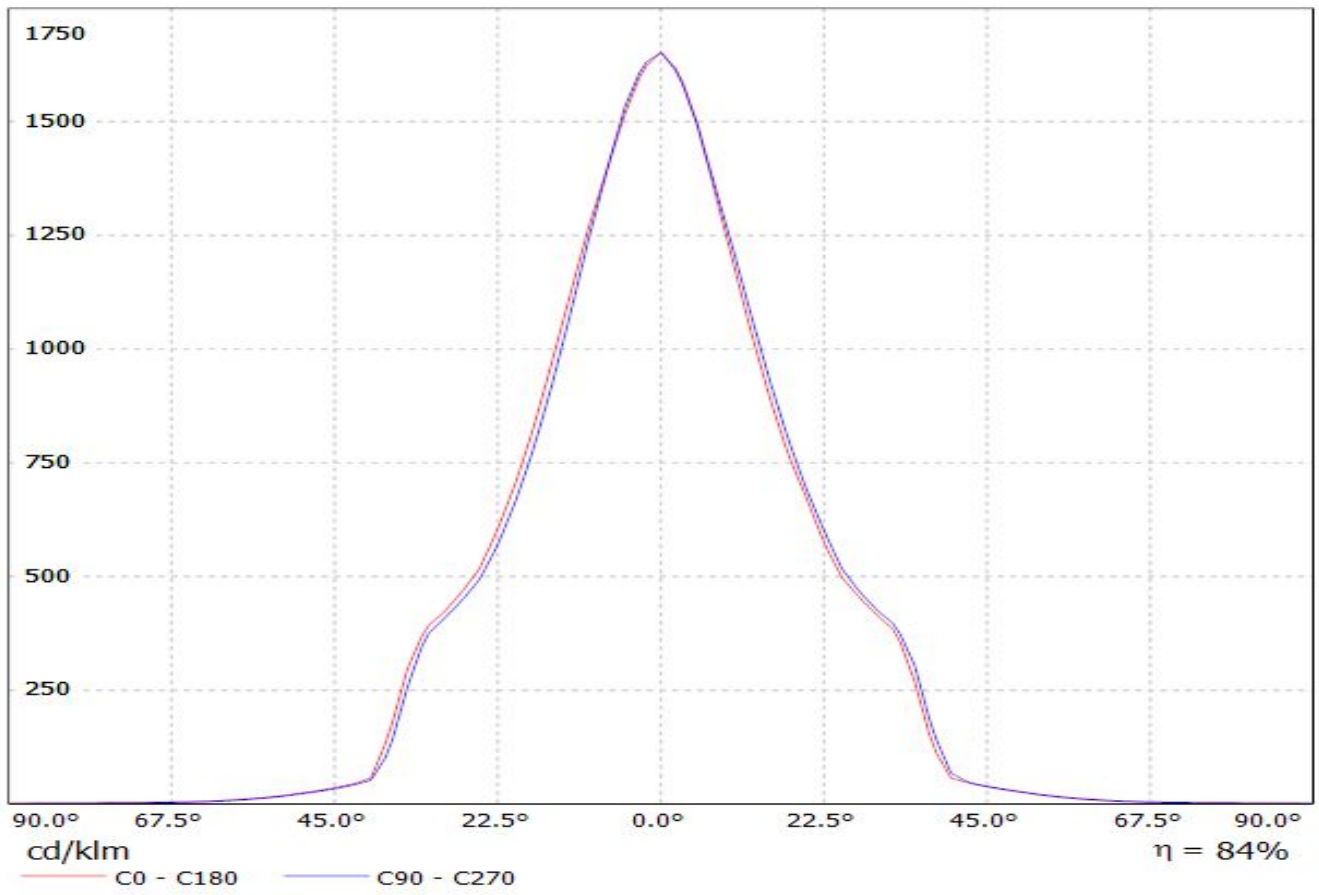

Luminaire: LEDiL Oy F13381_ANGELA-W_(CXM-14)

Lamps: 1 x LUMINUS_CXM-14_1114.36lm@250mA_P=8.36106W_I=249.8mA

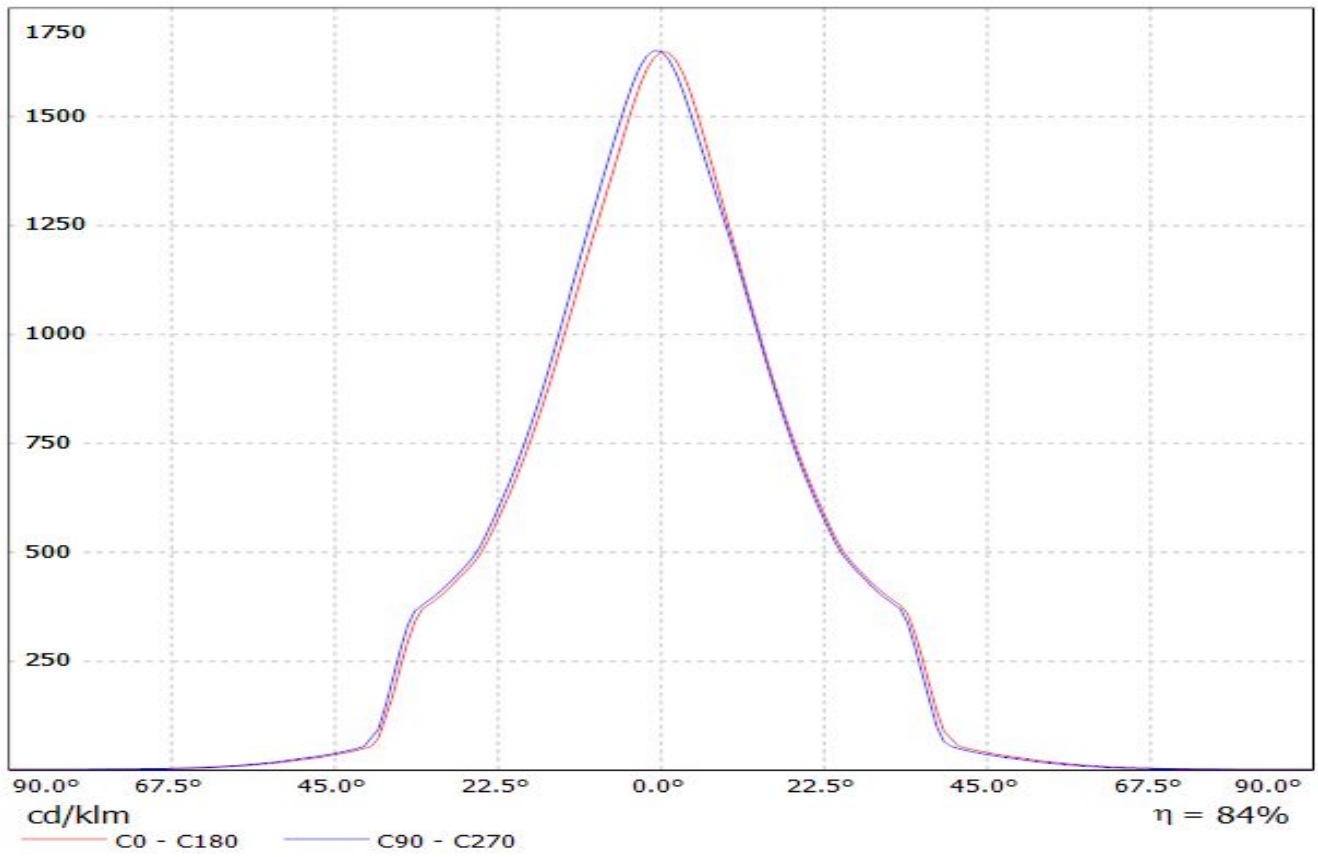

Luminaire: LEDiL Oy F13381_ANGELA-W_(LEP-2000-827-C-AC)
Lamps: 1 x OSRAM PrevaLED Core AC (LEP-2000-827-C-AC)

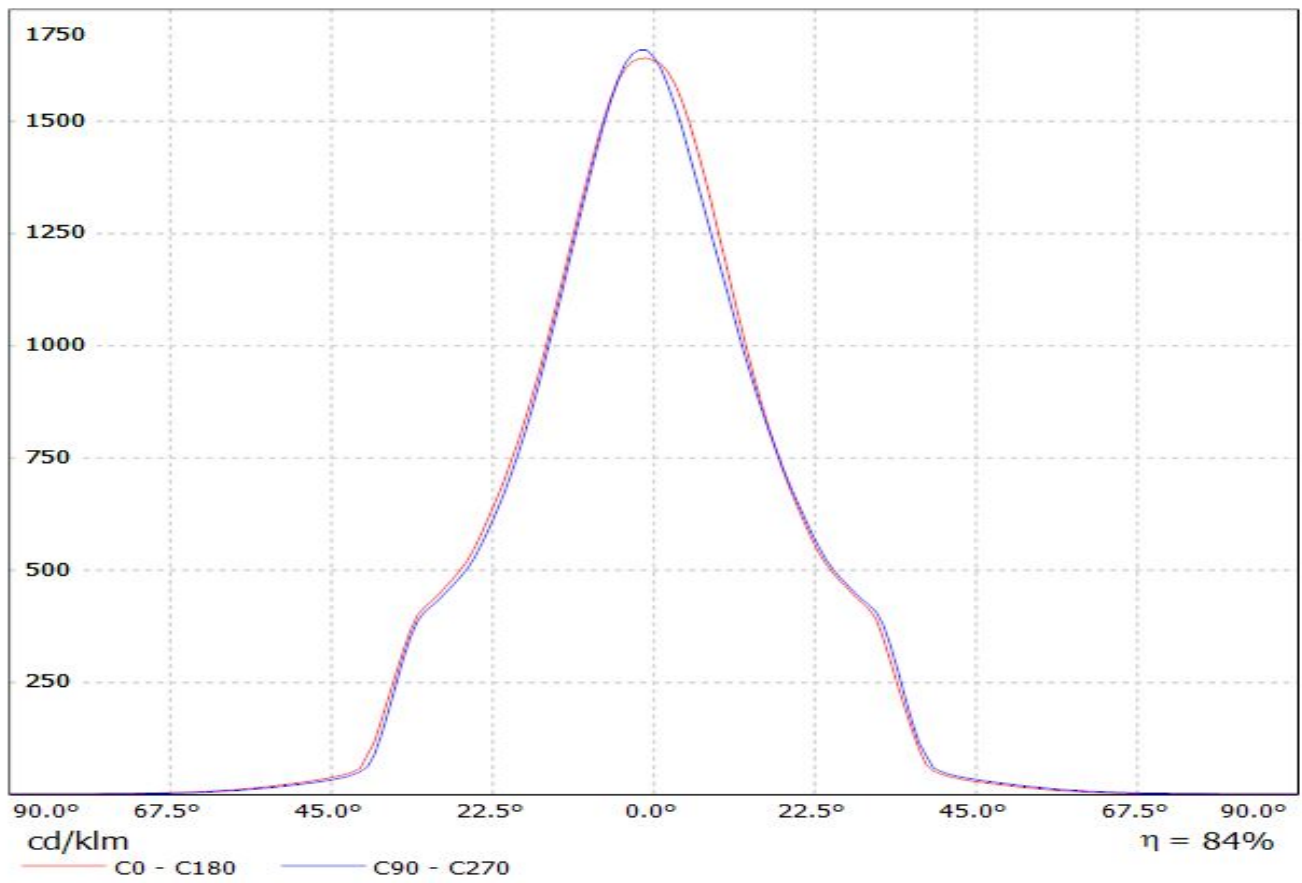

Luminaire: LEDiL Oy F13381_ANGELA-W (PrevaLED_Z4)Eff 84%
Lamps: 1 x Osram_PrevaLED_CORE_Z4_(PL-CORE-3000-830-Z4)_1423.93lm@250mA_P=10.7652W_I=249.9mA

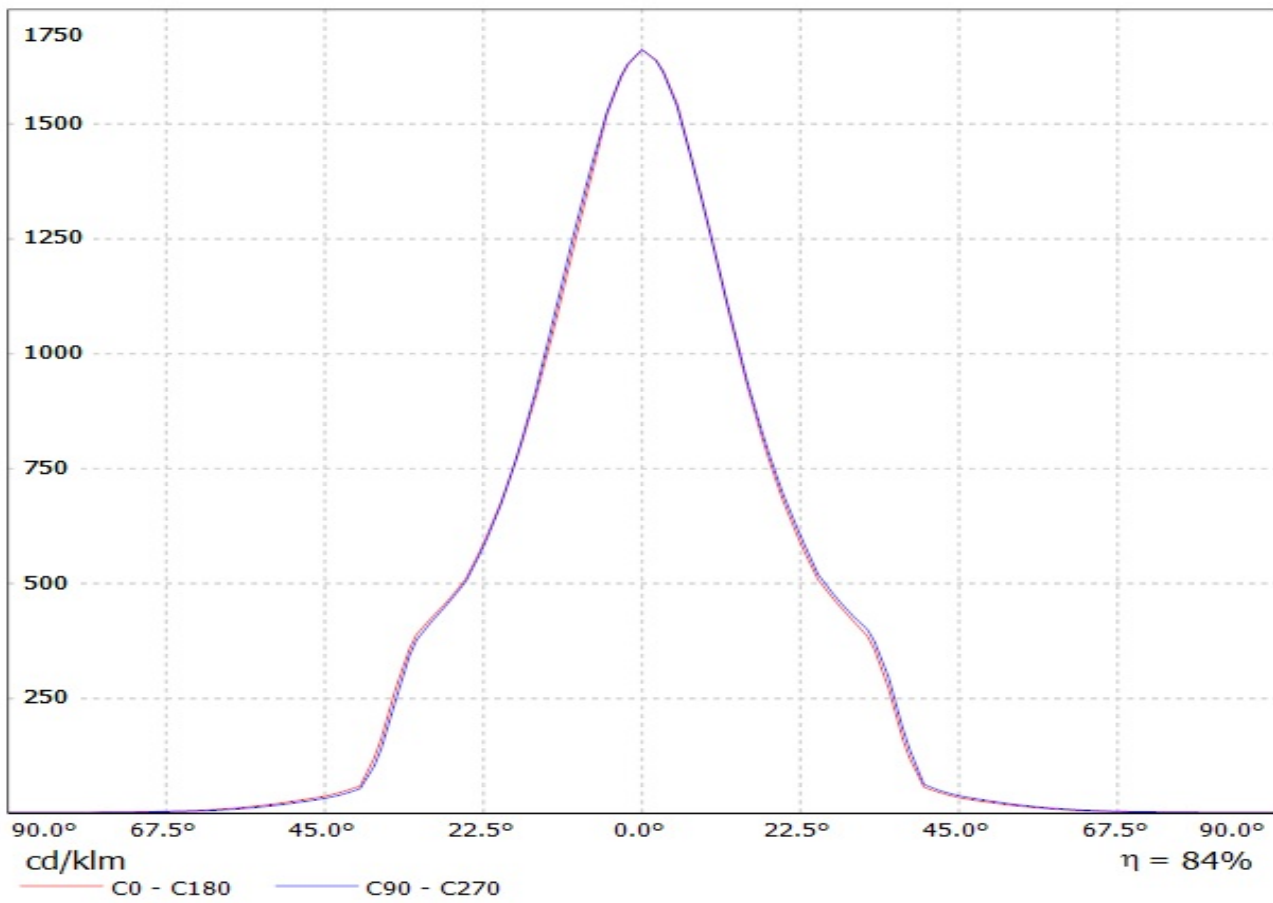

Luminaire: LEDiL Oy F13381_ANGELA-W_(WU-M-484)

Lamps: 1 x Vossloh_Schwabe-WU-M-484_(WU-M-484-830)_657.721lm@250mA_P=5.59451W_I=249.9mA

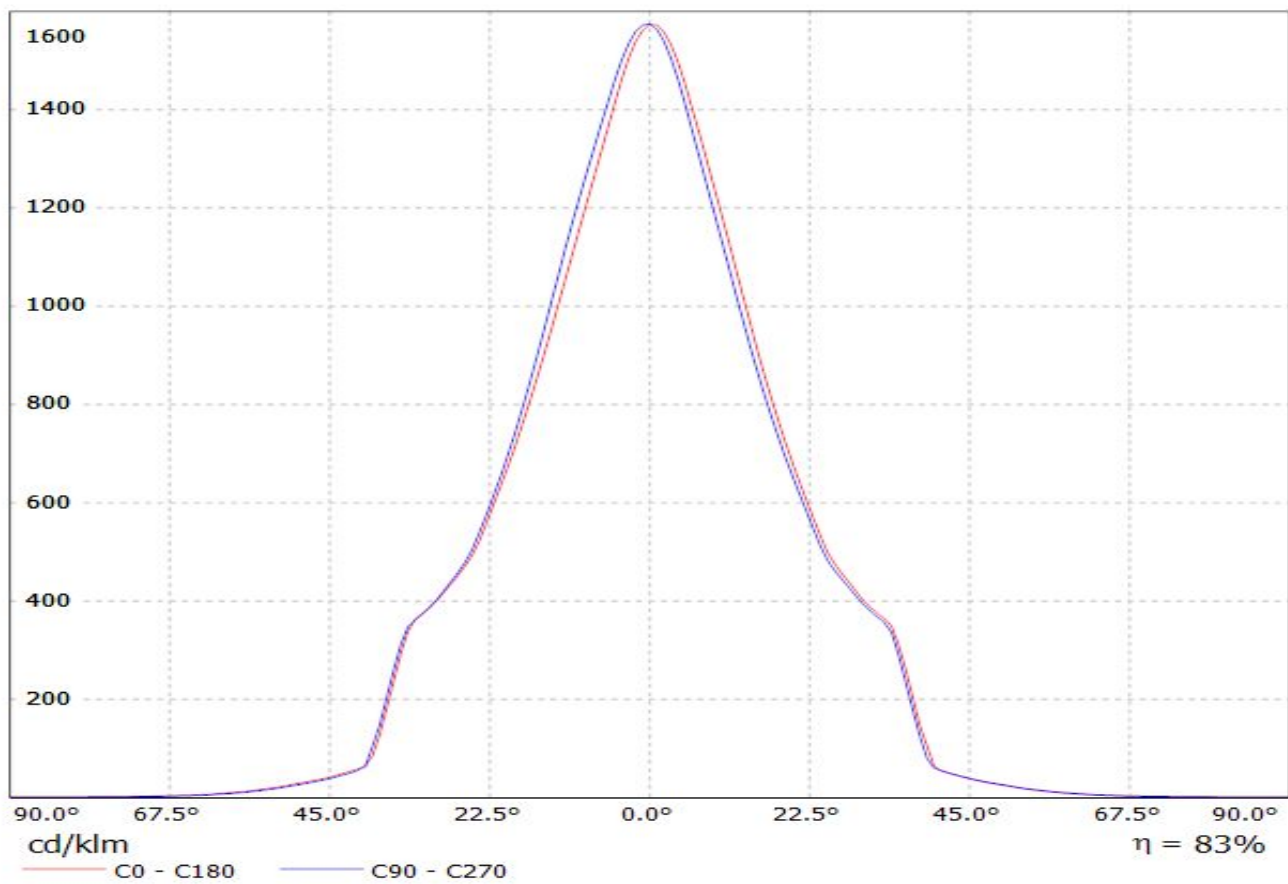

Luminaire: LEDiL Oy F13381_ANGELA-W_(SOLERIQ_S19_&_TE_2213407-2)
Lamps: 1 x OSRAM_SOLERIQ_S19_(GW_KAHJB1.EM)_1385.15lm@250mA_CCT=3000K_P=10.5613W_I=249.8mA

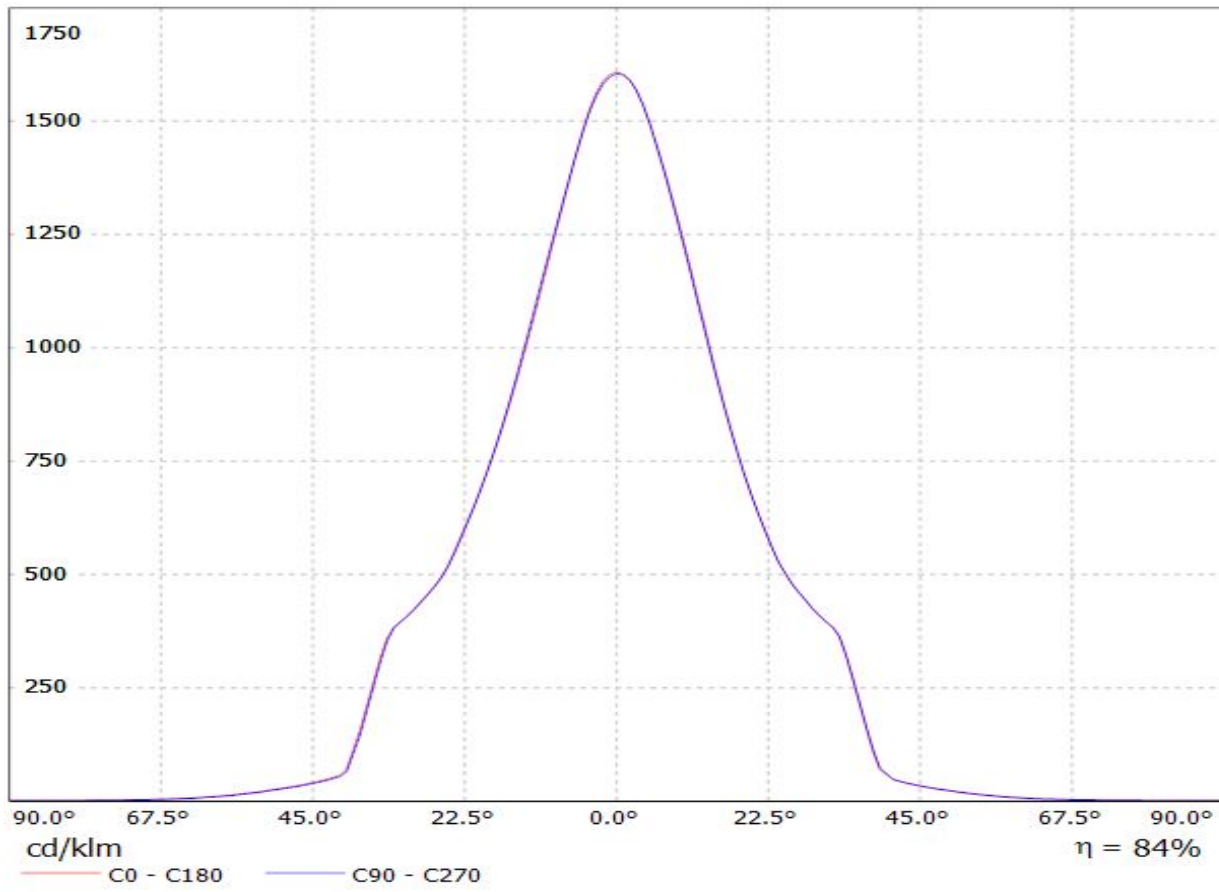

Luminaire: LEDiL Oy F13381_ANGELA-W_(NSBxL121A)

Lamps: 1 x Nichia_NSBxL121A_914.478lm@250mA_P=7.56872W_I=249.9mA

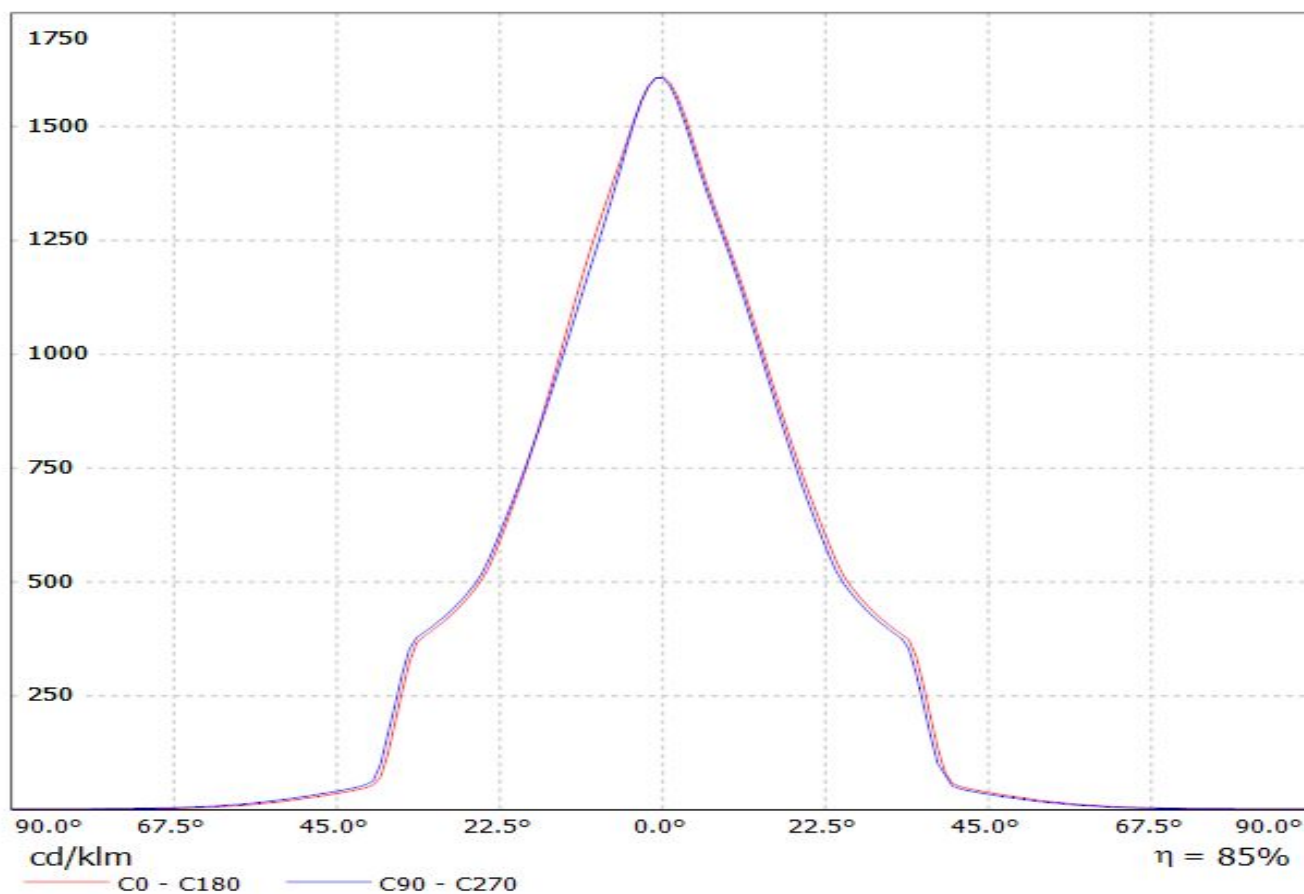

Luminaire: LEDiL Oy F13381_ANGELA-W (STARK_LES19)

Lamps: 1 x Tridonic_STARK_SLE_G3_LES19_(Stark-SLE-PURE-G3-19-2000-840-CLA)_1050.59lm@250mA_P=8.3639W_I=249.9mA

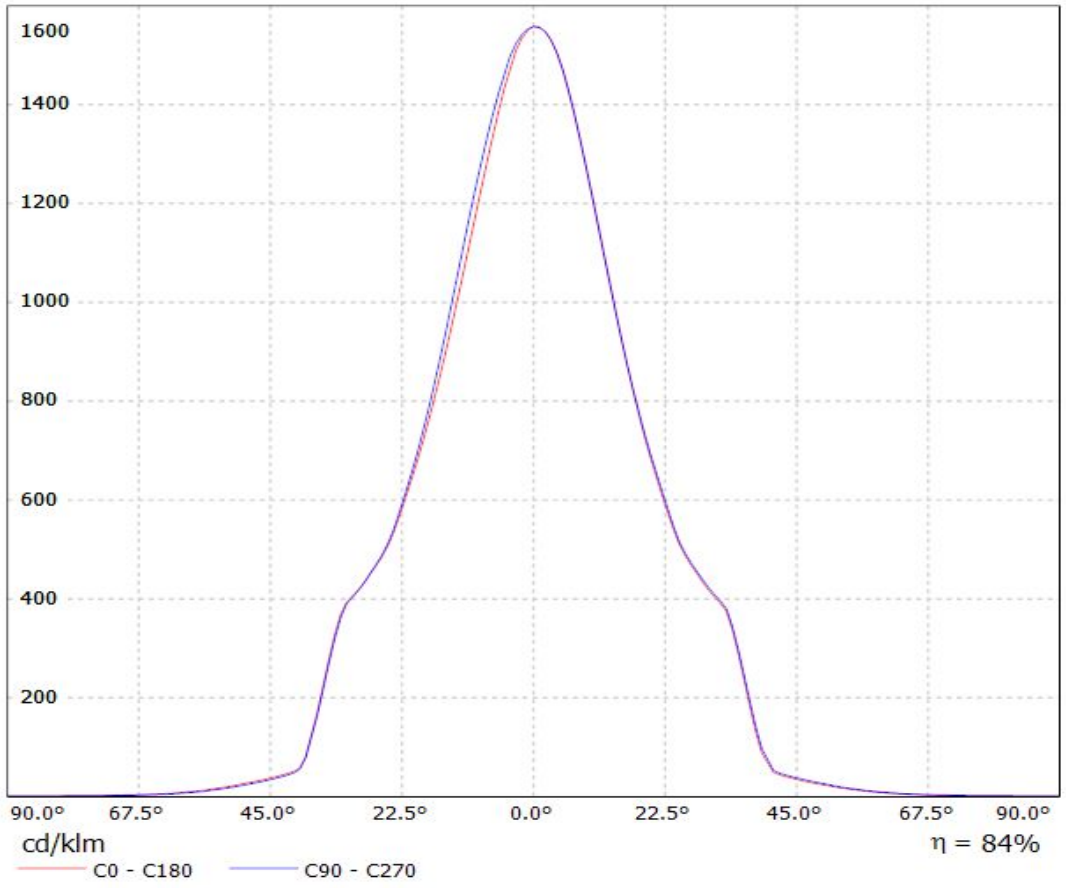

Luminaire: LEDiL Oy F13381_ANGELA-W_(COB-LC026B) Eff.83.8%
Lamps: 1 x SAMSUNG_COB-LC026B_(SPHWWTHDNC25YHV52F)
_1122.94lm@250mA_P=8.2479W_I=249.8mA

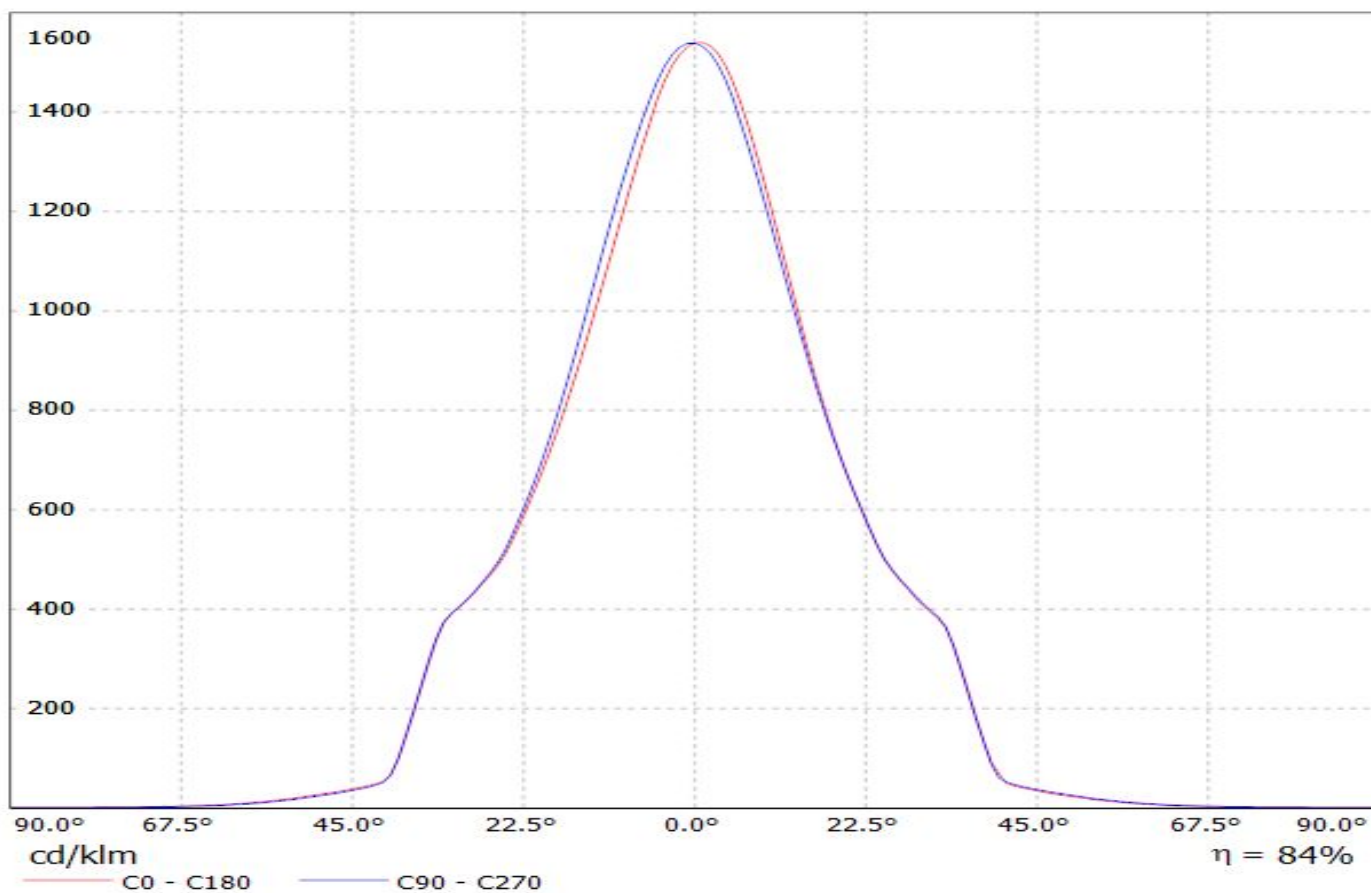

Luminaire: LEDiL F13381_ANGELA-W_(WU-M-461)
Lamps: 1 x Vossloh-Schwabe WU-M-461-827 767lm@250mA

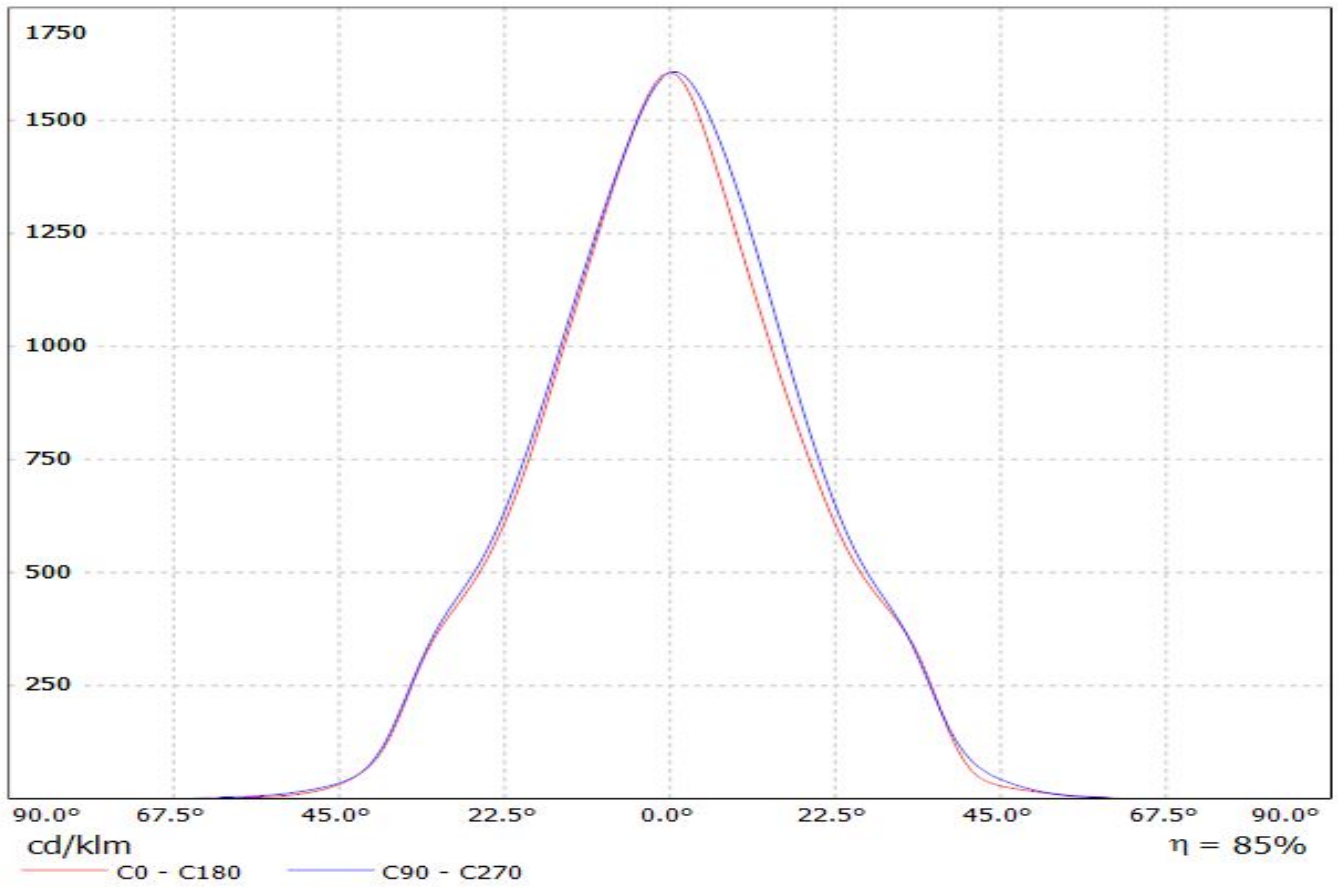

Luminaire: LEDiL Oy F13381_ANGELA-W_(WU-M-485)

Lamps: 1 x Vossloh_Schwabe-WU-M-485_(WU-M-485-830)_1209.62lm@250mA_P=8.43849W_I=249.8mA

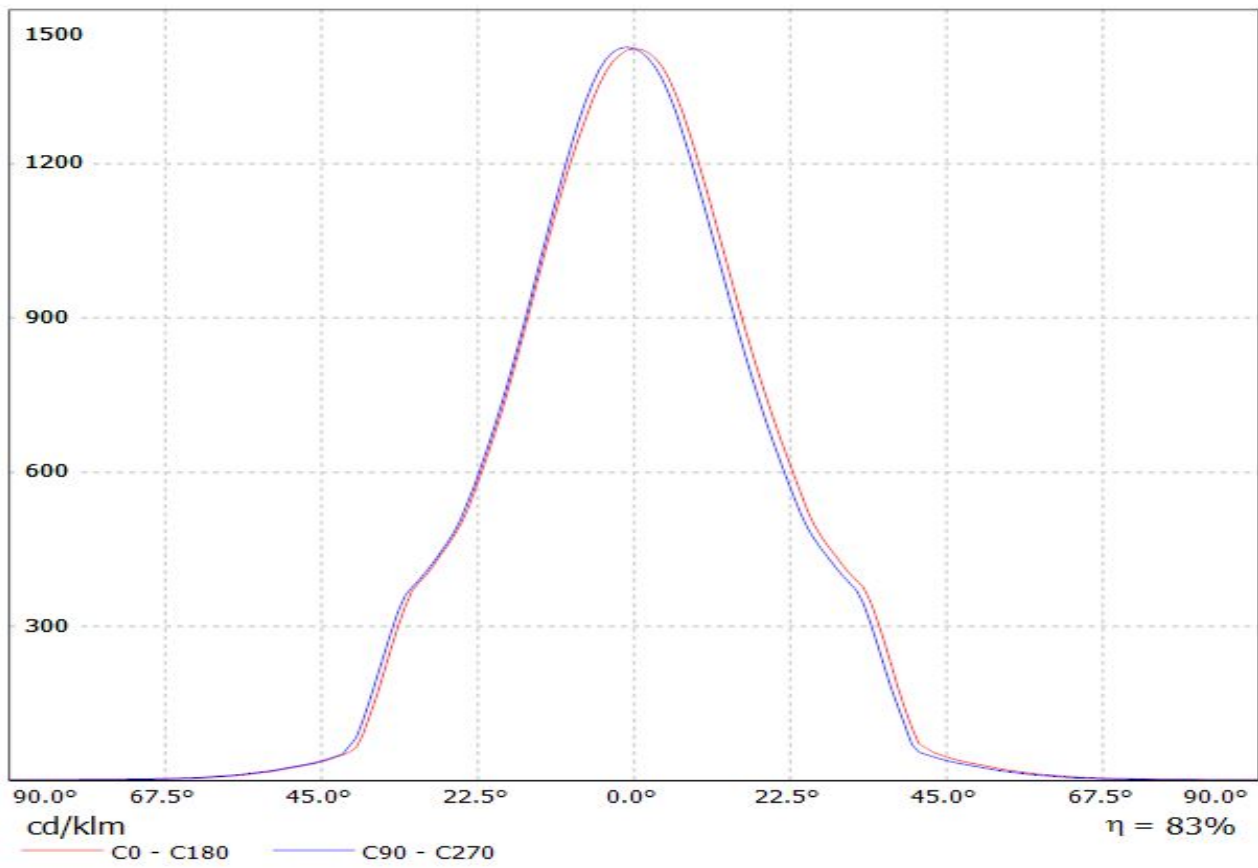

Luminaire: LEDiL Oy F13381_ANGELA-W_(WU-M-486) Eff.83.2%
Lamps: 1 x Vossloh_Schwabe-WU-M-486_(WU-M-486-830)
_1474.55lm@250mA_P=10.4456W_I=249.8mA

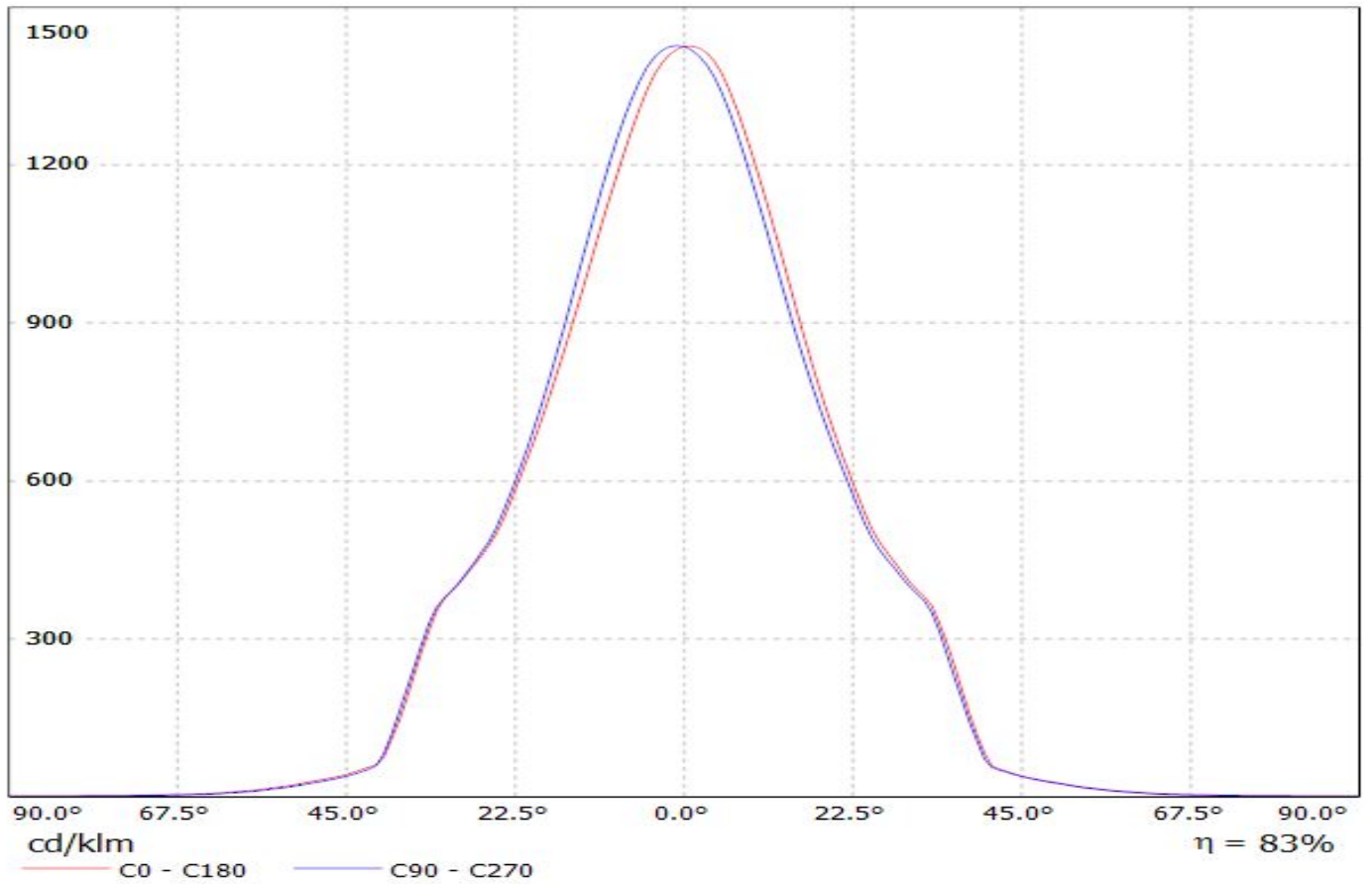

Luminaire: LEDiL F13381_ANGELA-W_(WU-M-462)
Lamps: 1 x Vossloh-Schwabe WU-M-462-827 1140lm@250mA

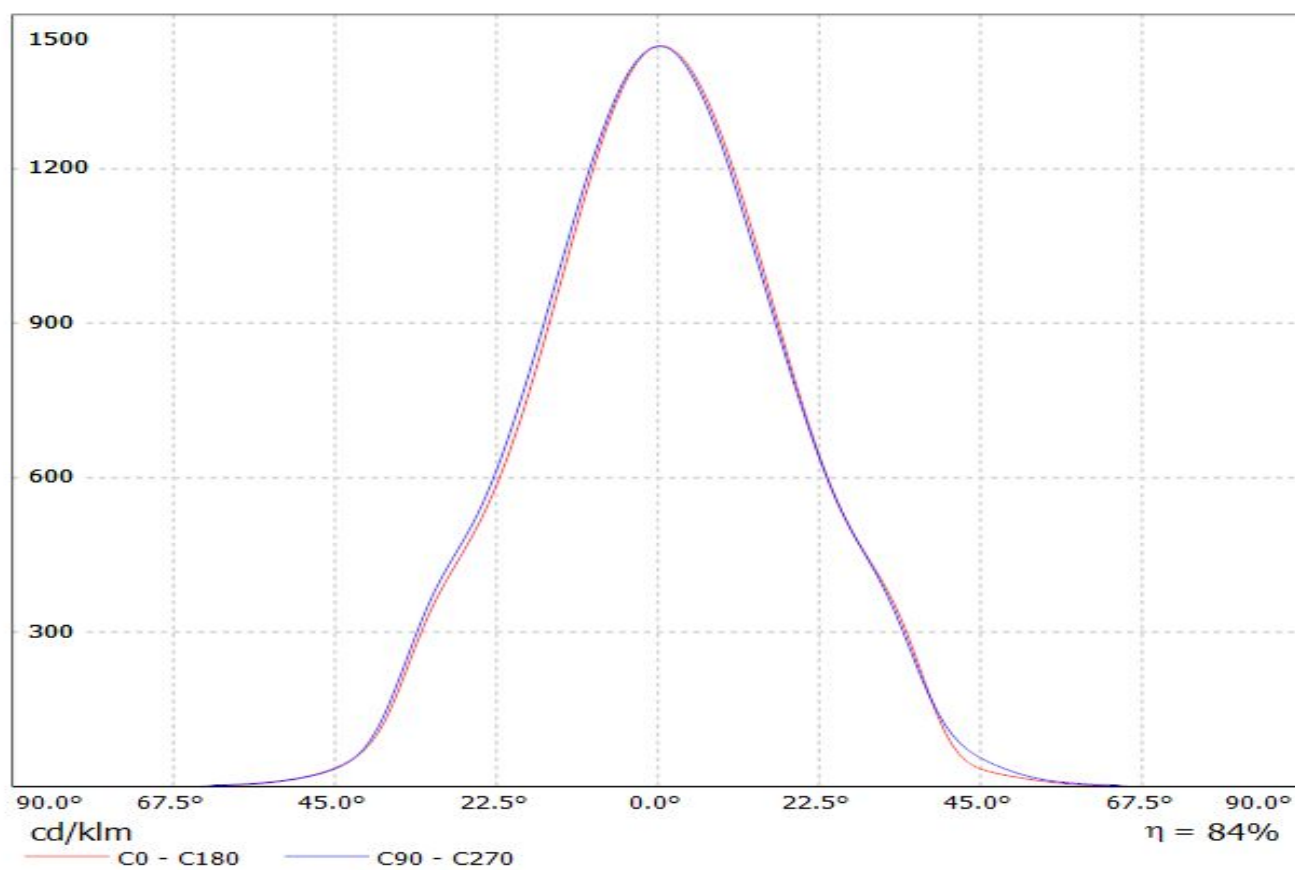

Luminaire: LEDiL F13381_ANGELA-W_(WU-M-464)
Lamps: 1 x Vossloh-Schwabe WU-M-464-827 1480lm@250mA

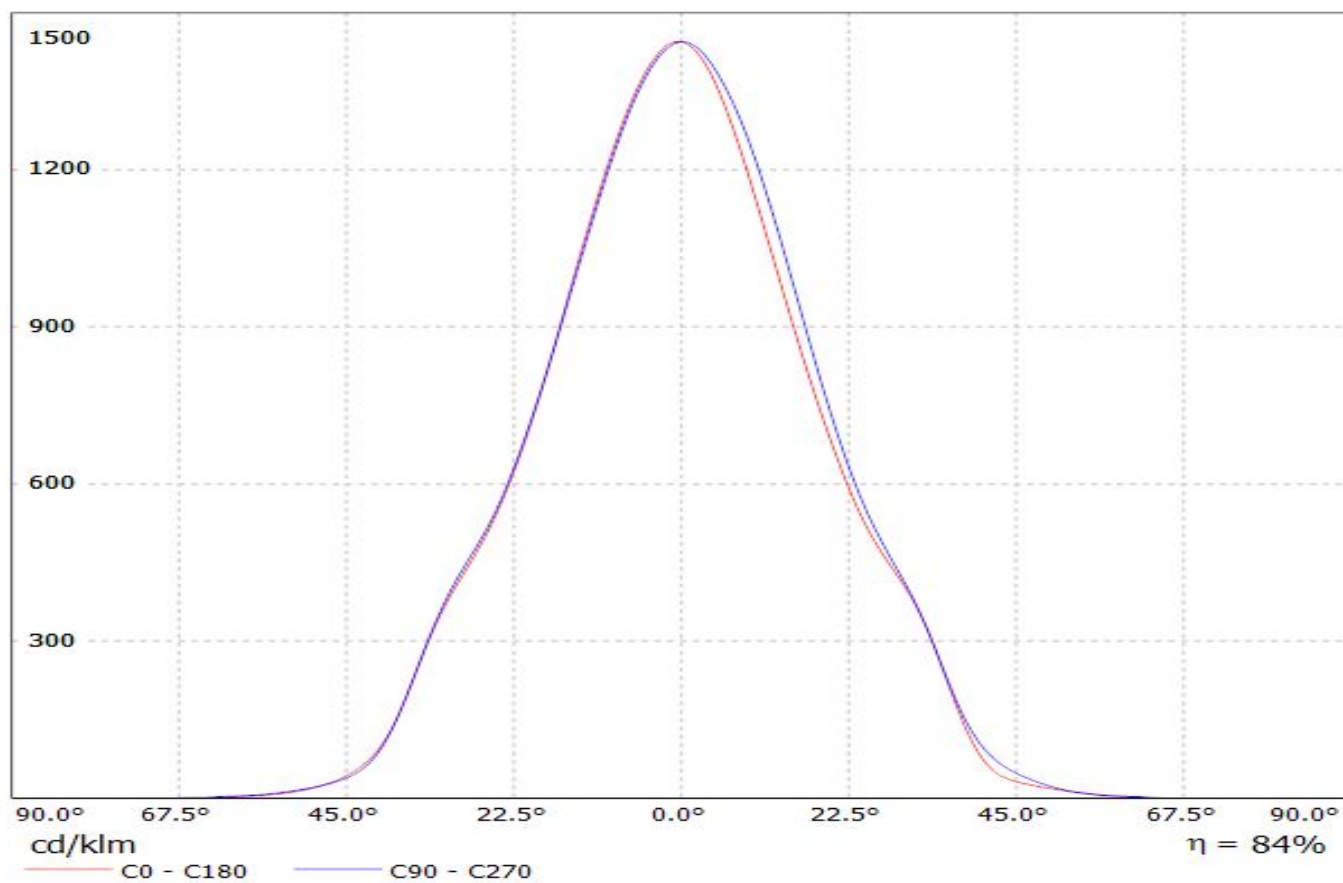

Luminaire: LEDiL Oy F13381_ANGELA-W_(CXA3590)

Lamps: 1 x CREE_CXA3590_(CXA3590-30F-BD-R0H-0002)_2640.14lm@250mA_CCT=3000K_P=16.3941W_I=249.8mA

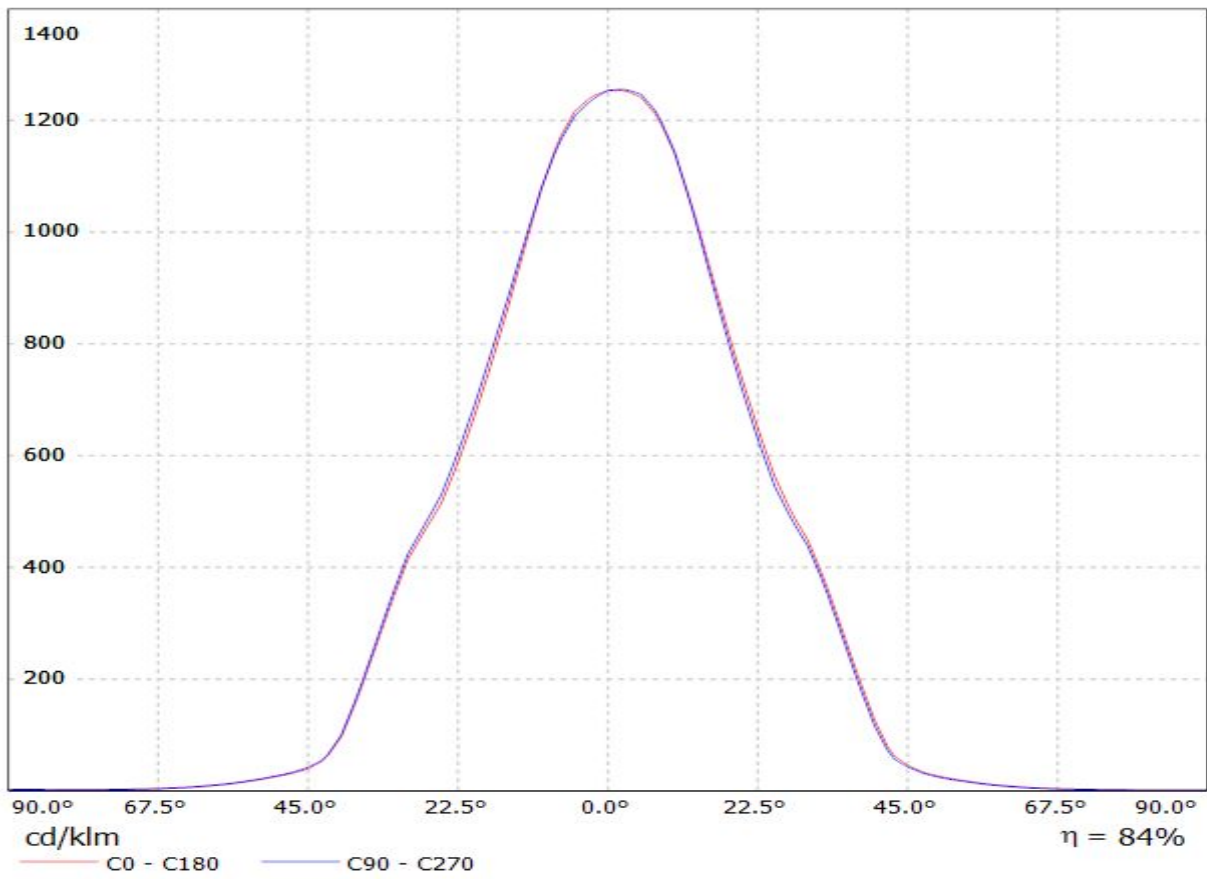

Luminaire: LEDiL Oy F13381_ANGELA-W_(LEP-800-827-C-AC)

Lamps: 1 x OSRAM PrevaLED Core AC (LEP-800-827-C-AC) 910lm@60mA U:230V P:14W

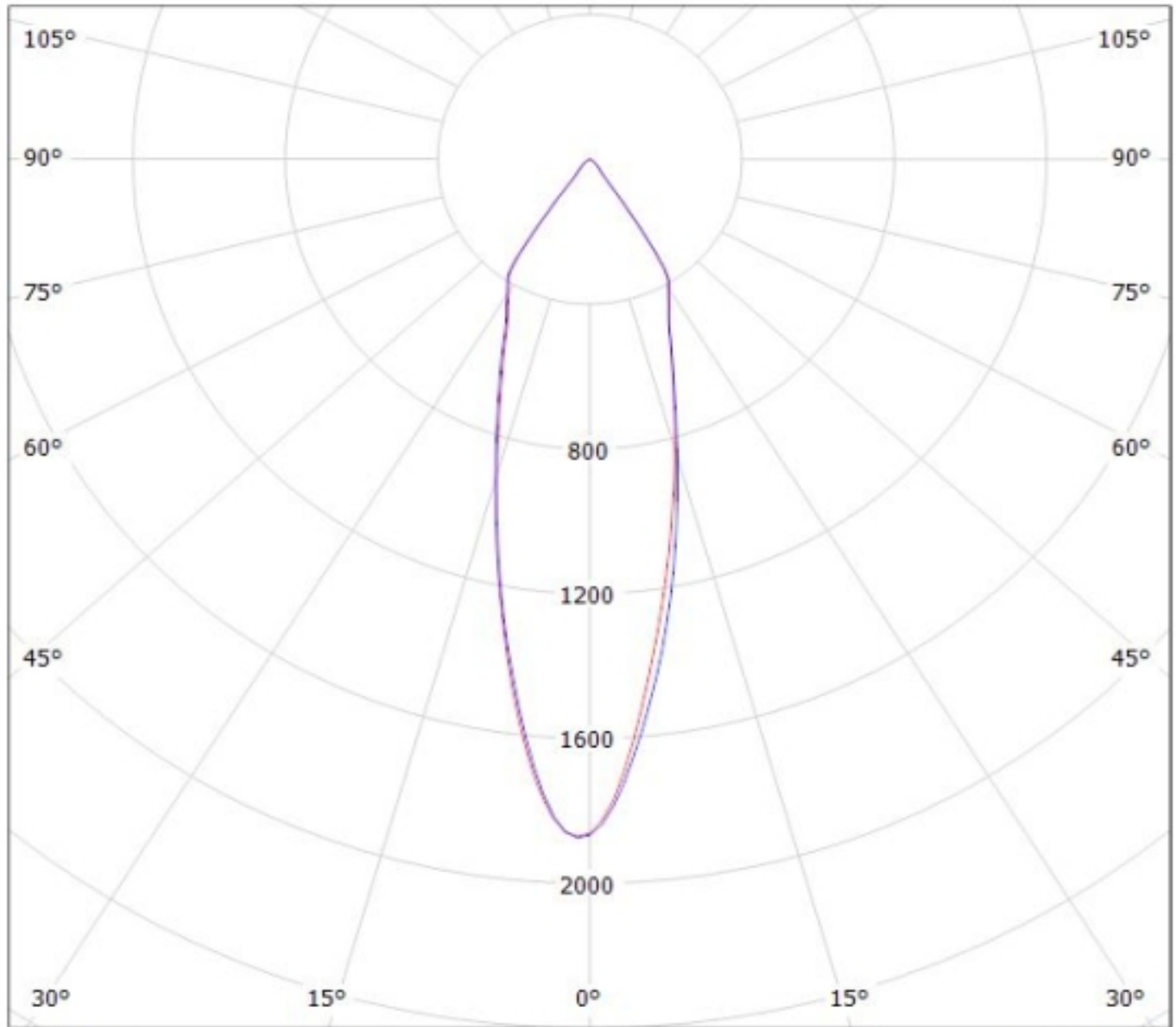

cd/klm

— C0 - C180

— C90 - C270

$\eta = 84\%$

Luminaire: LEDiL Oy F13381_ANGELA-W_(COB_1205) Eff.83.8%
Lamps: 1 x Luxeon_COB_1205_1092.75lm@250mA_P=8.33092W_I=249.9mA

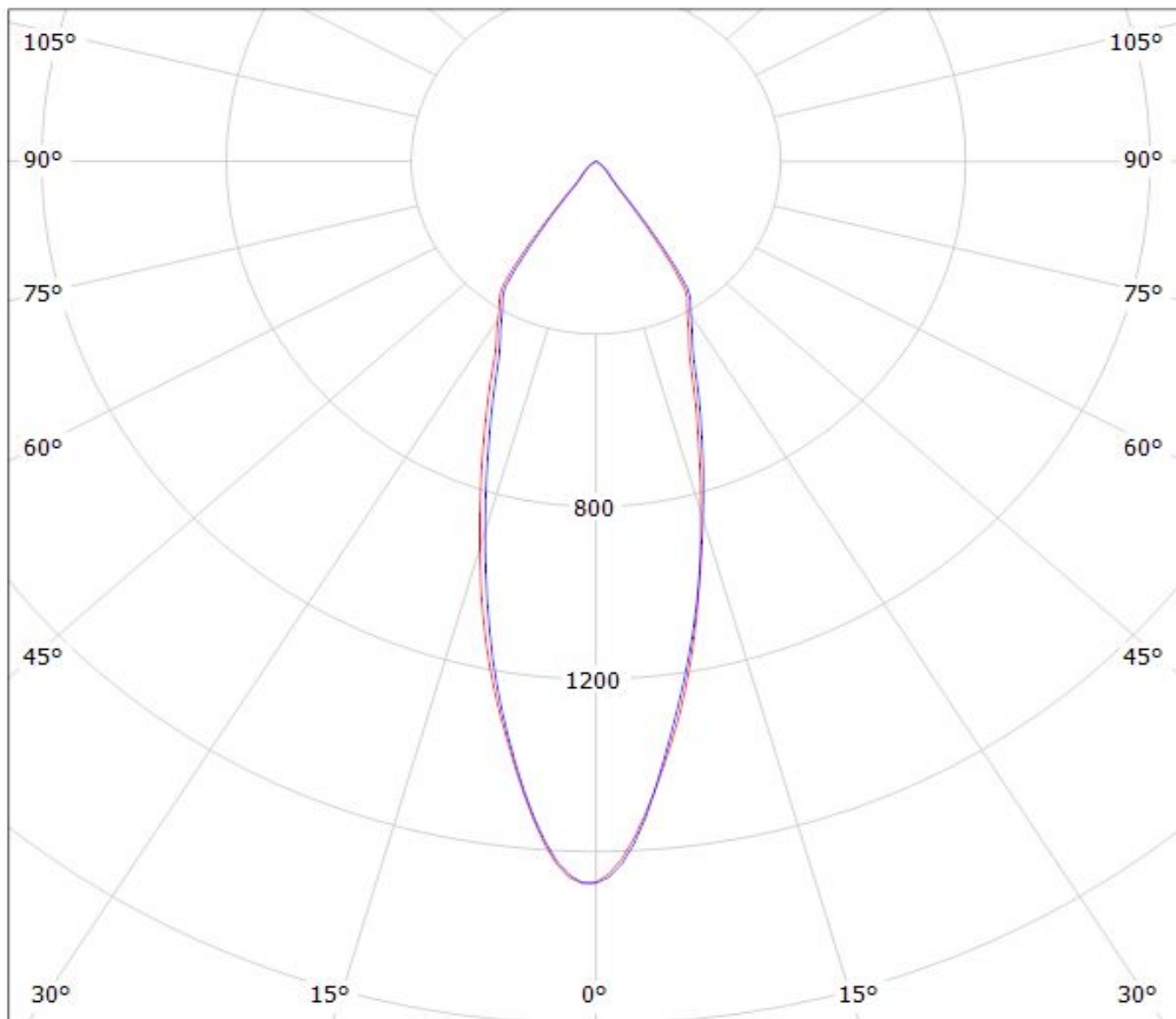

cd/klm

— C0 - C180 — C90 - C270

$\eta = 84\%$

Luminaire: LEDil Oy F13381_ANGELA-W_(Soleriq_S13) Efficiency=85%

Lamps: 1 x Osram Soleriq S13 (GW KAGHB1.EM) 855lm @ 250mA CCT=3100K P=7.5W I=250mA

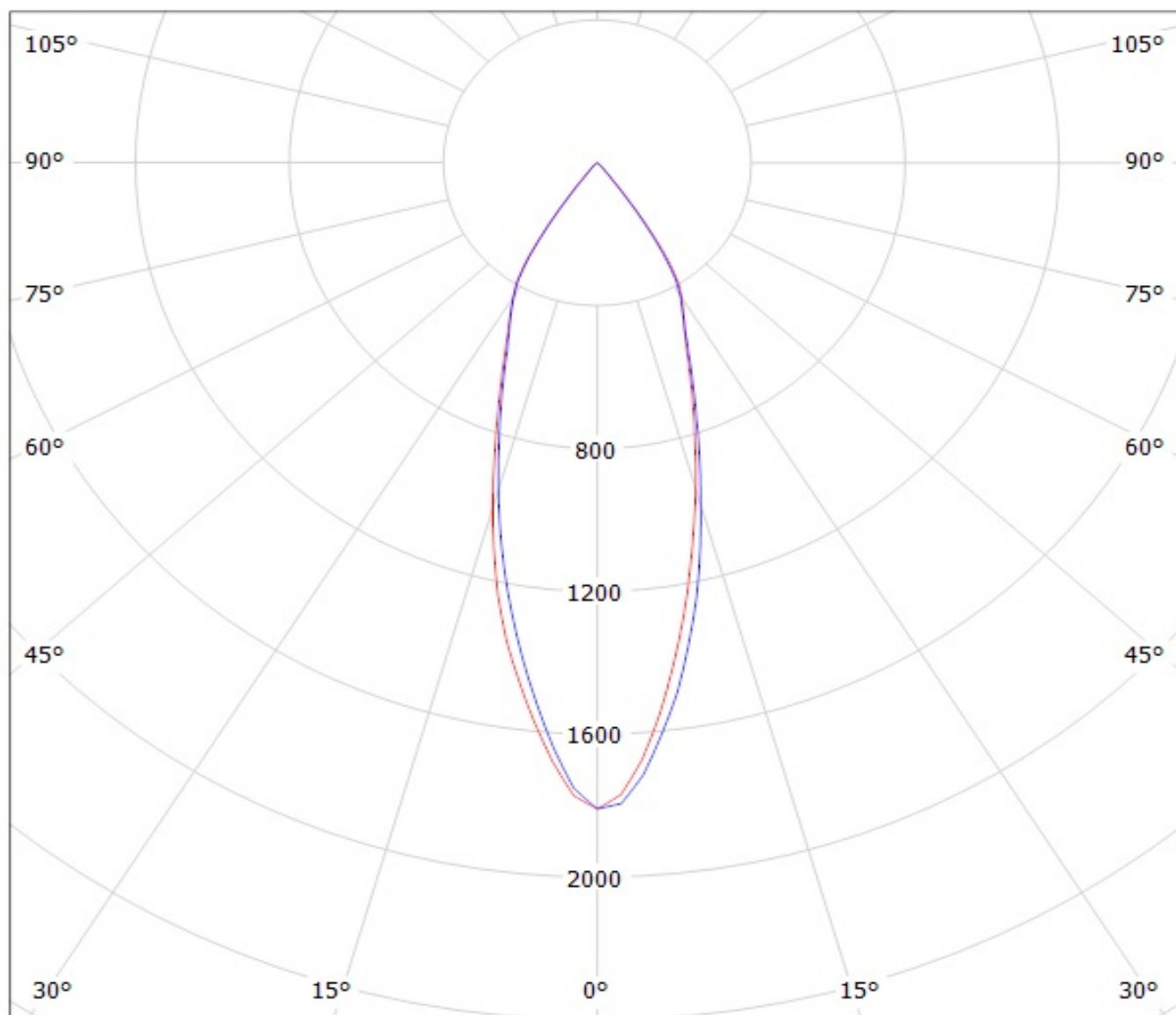

cd/klm

— C0 - C180

— C90 - C270

Luminaire: LEDiL Oy F13381_ANGELA-W_(COB_1208) Eff.83.8%
Lamps: 1 x Luxeon_COB_1208_1039.97lm@250mA_P=8.28793W_I=249.9mA

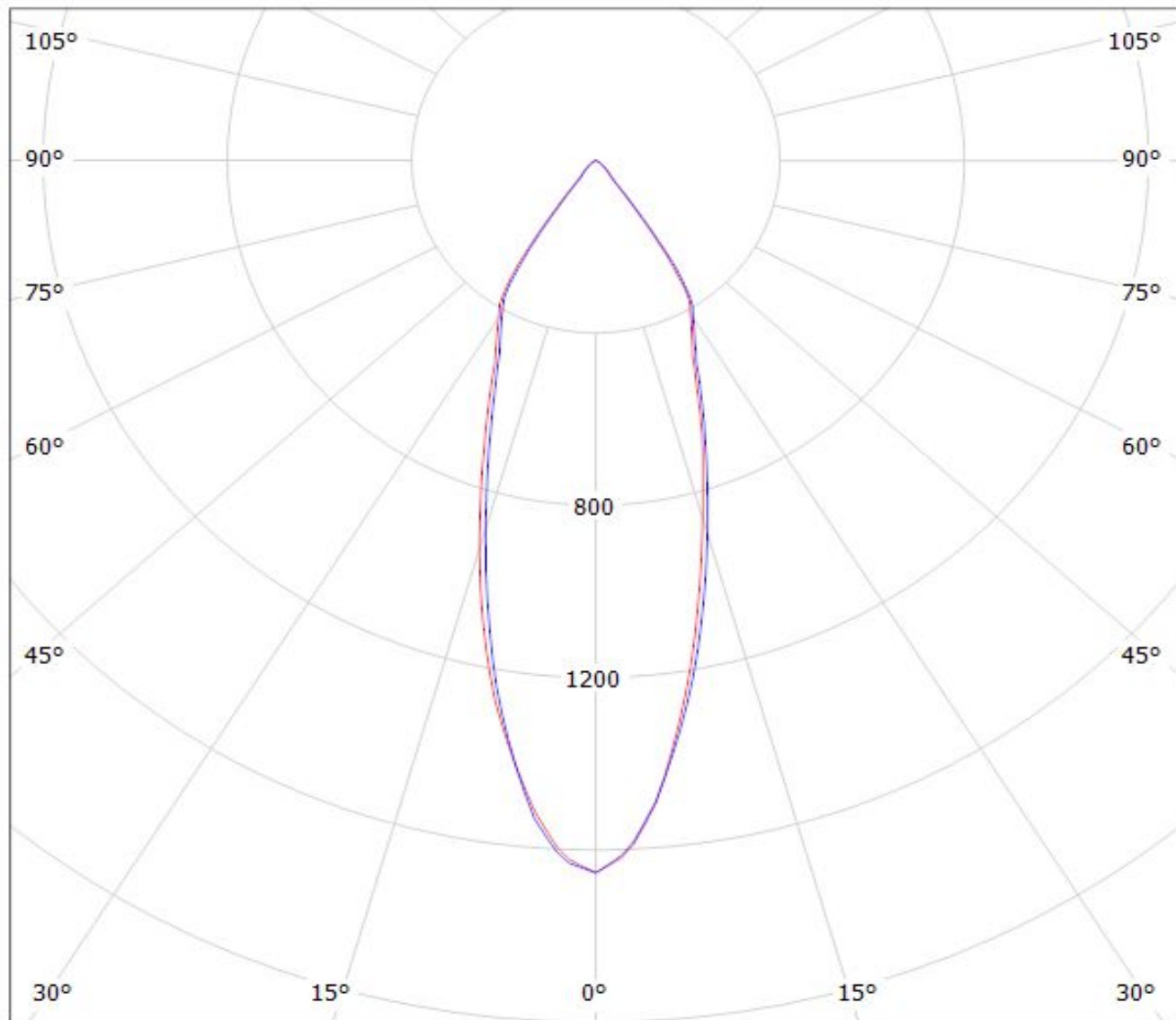

cd/klm

$\eta = 84\%$

— C0 - C180

— C90 - C270

Luminaire: LEDiL Oy F13381_ANGELA-W_(CXM-14)

Lamps: 1 x LUMINUS_CXM-14_1114.36lm@250mA_P=8.36106W_I=249.8mA

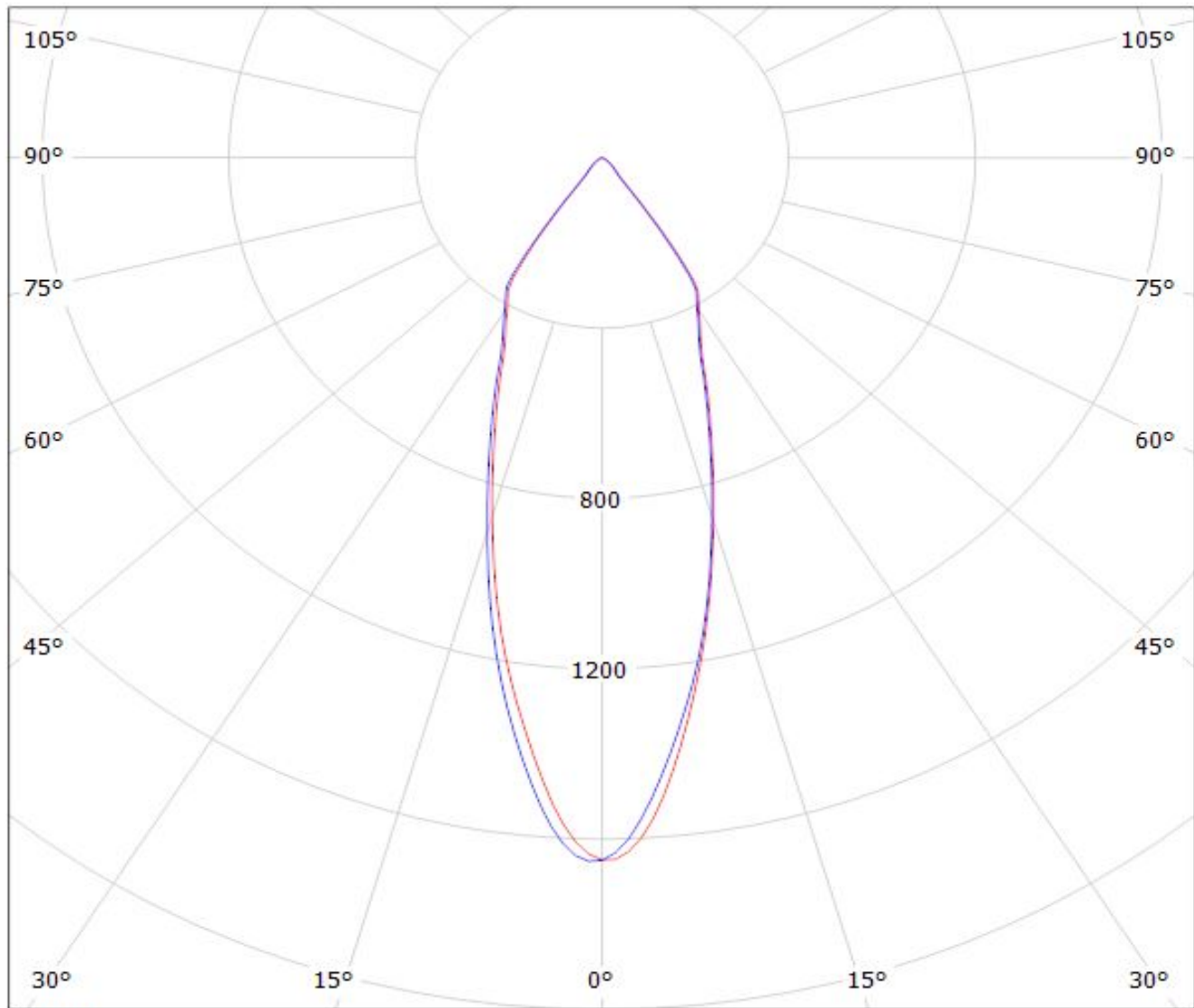

cd/klm

— C0 - C180

— C90 - C270

$\eta = 84\%$

Luminaire: LEDiL Oy F13381_ANGELA-W_(LEP-2000-827-C-AC)
Lamps: 1 x OSRAM PrevaLED Core AC (LEP-2000-827-C-AC)

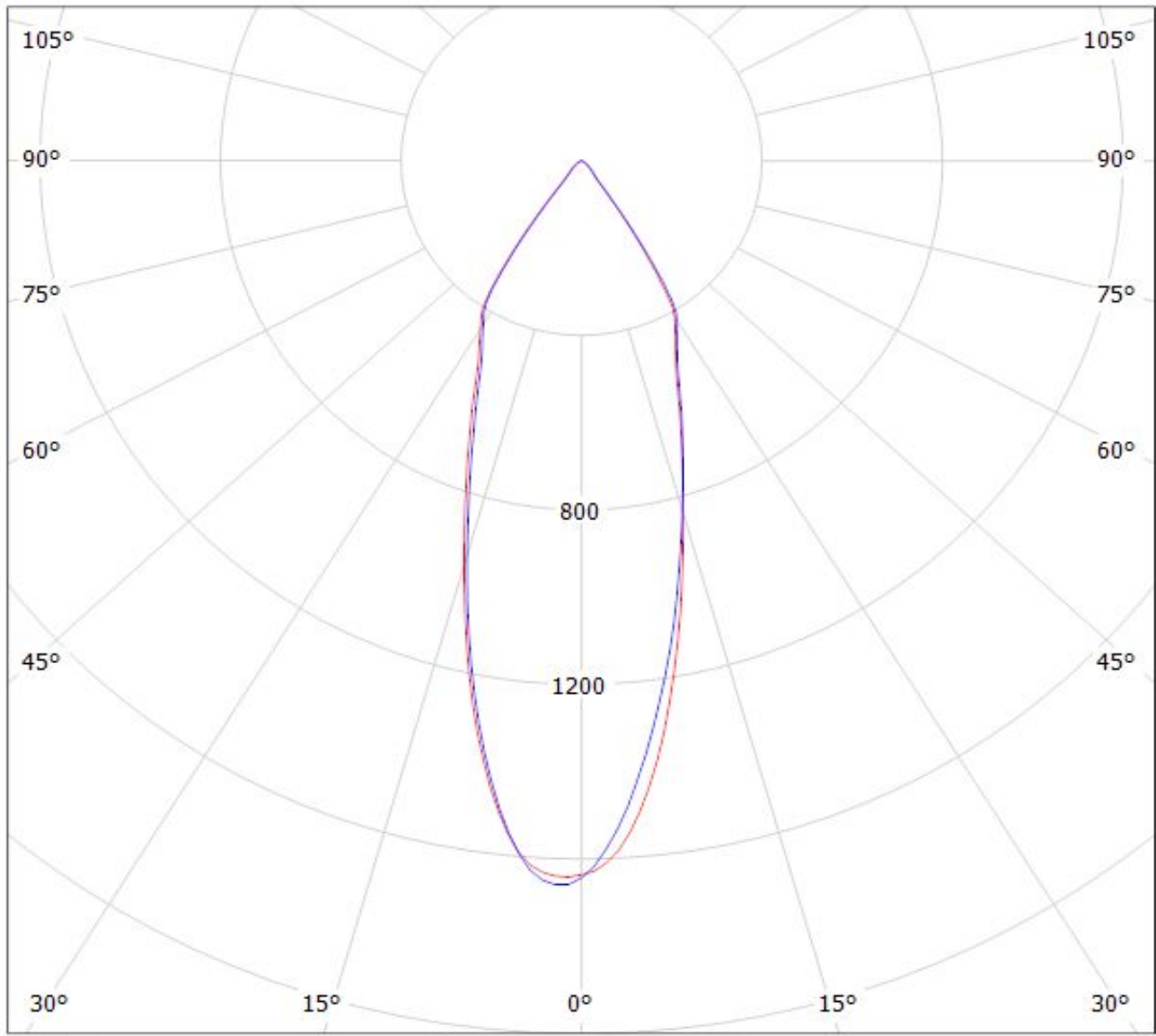

cd/klm
— C0 - C180 — C90 - C270

$\eta = 84\%$

Luminaire: LEDiL Oy F13381_ANGELA-W_(PrevaLED_Z4)Eff 84%

Lamps: 1 x Osram_PrevaLED_CORE_Z4_(PL-CORE-3000-830-Z4)_1423.93lm@250mA_P=10.7652W_I=249.9mA

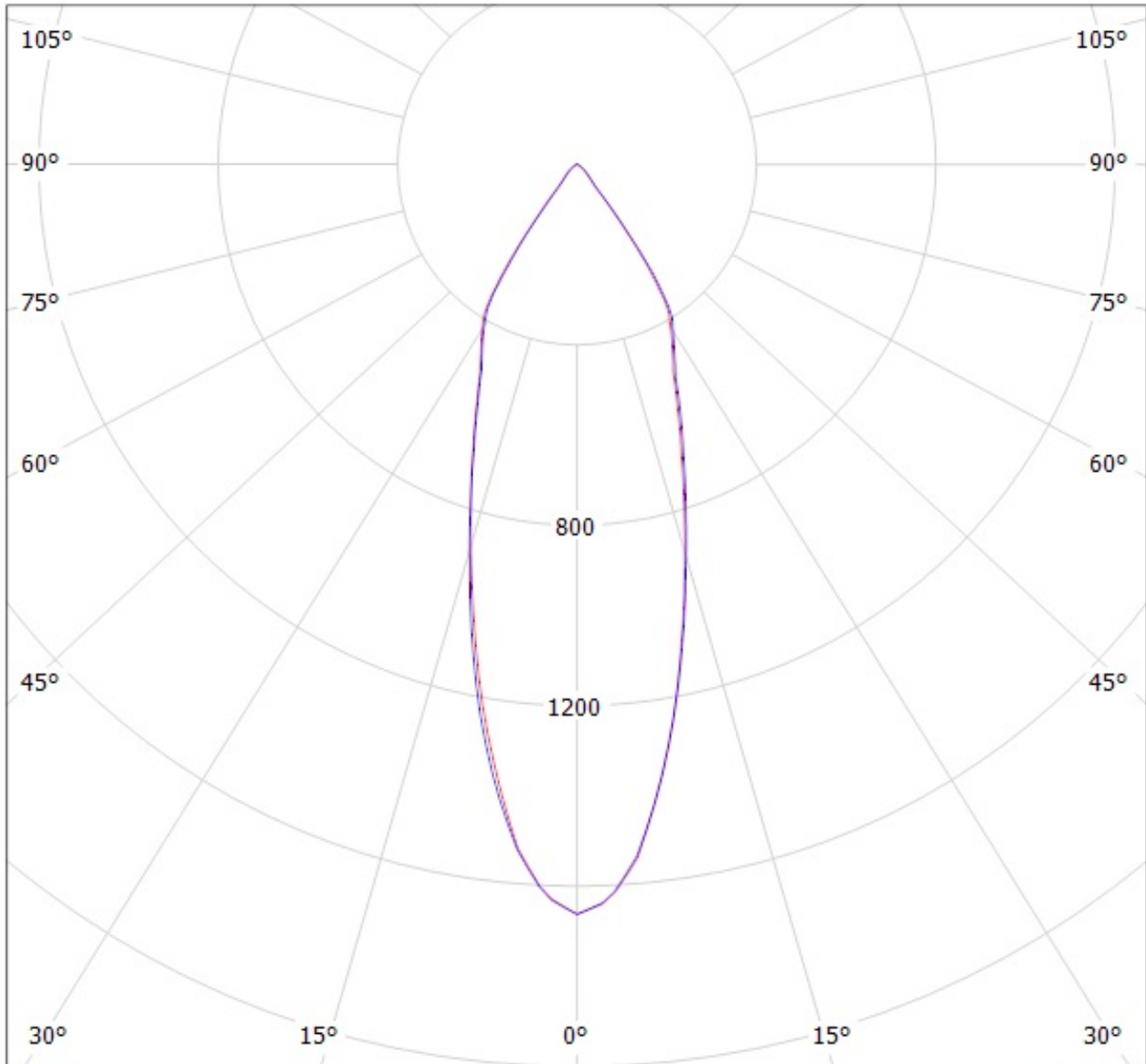

cd/klm

$\eta = 84\%$

— C0 - C180

— C90 - C270

Luminaire: LEDiL Oy F13381_ANGELA-W_(WU-M-484)

Lamps: 1 x Vossloh_Schwabe-WU-M-484_(WU-M-484-830)_657.721lm@250mA_P=5.59451W_I=249.9mA

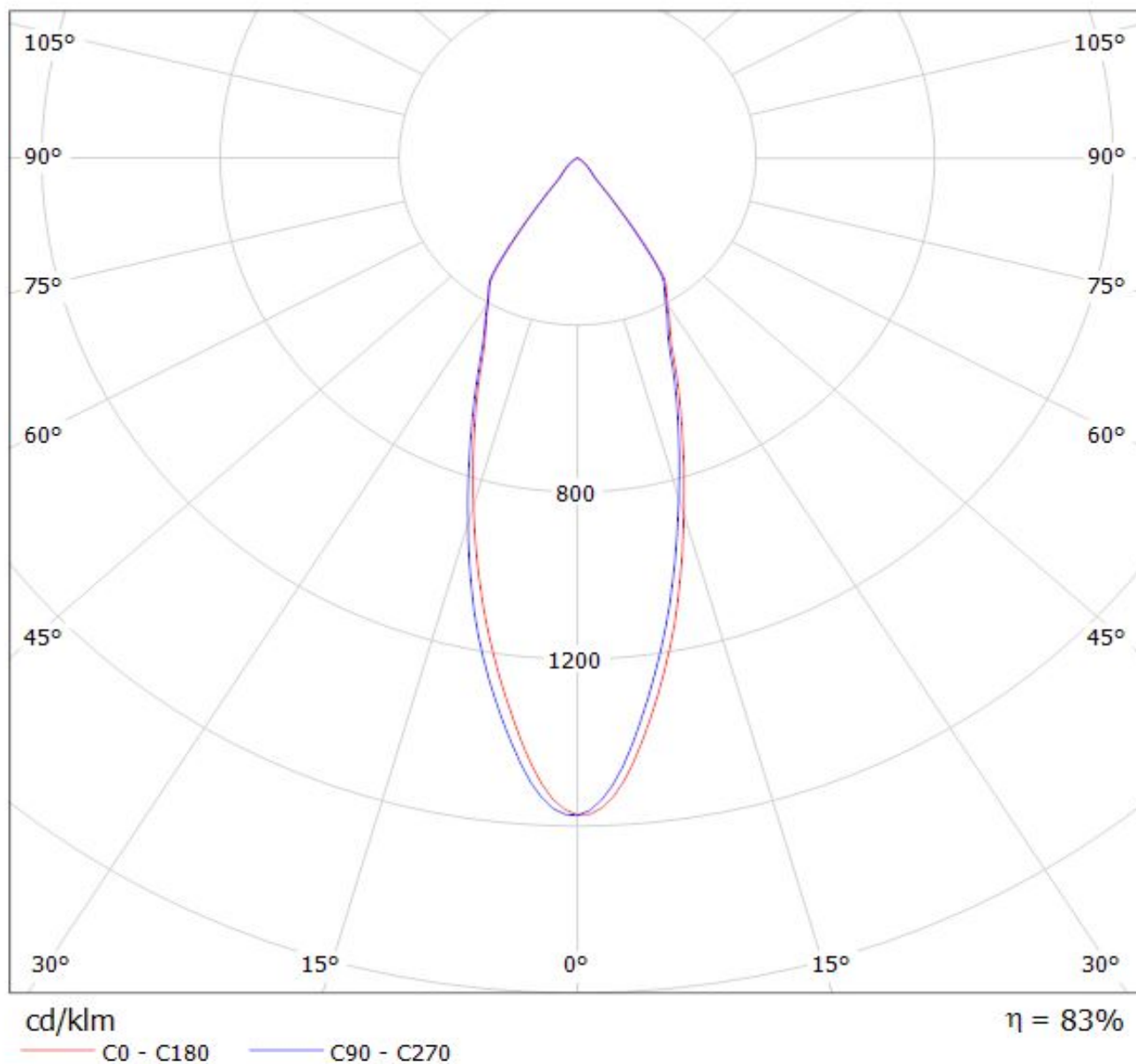

Luminaire: LEDiL Oy F13381_ANGELA-W_(SOLERIQ_S19_&_TE_2213407-2)

Lamps: 1 x OSRAM_SOLERIQ_S19_(GW_KAHJB1.EM)_1385.15lm@250mA_CCT=3000K_P=10.5613W_I=249.8mA

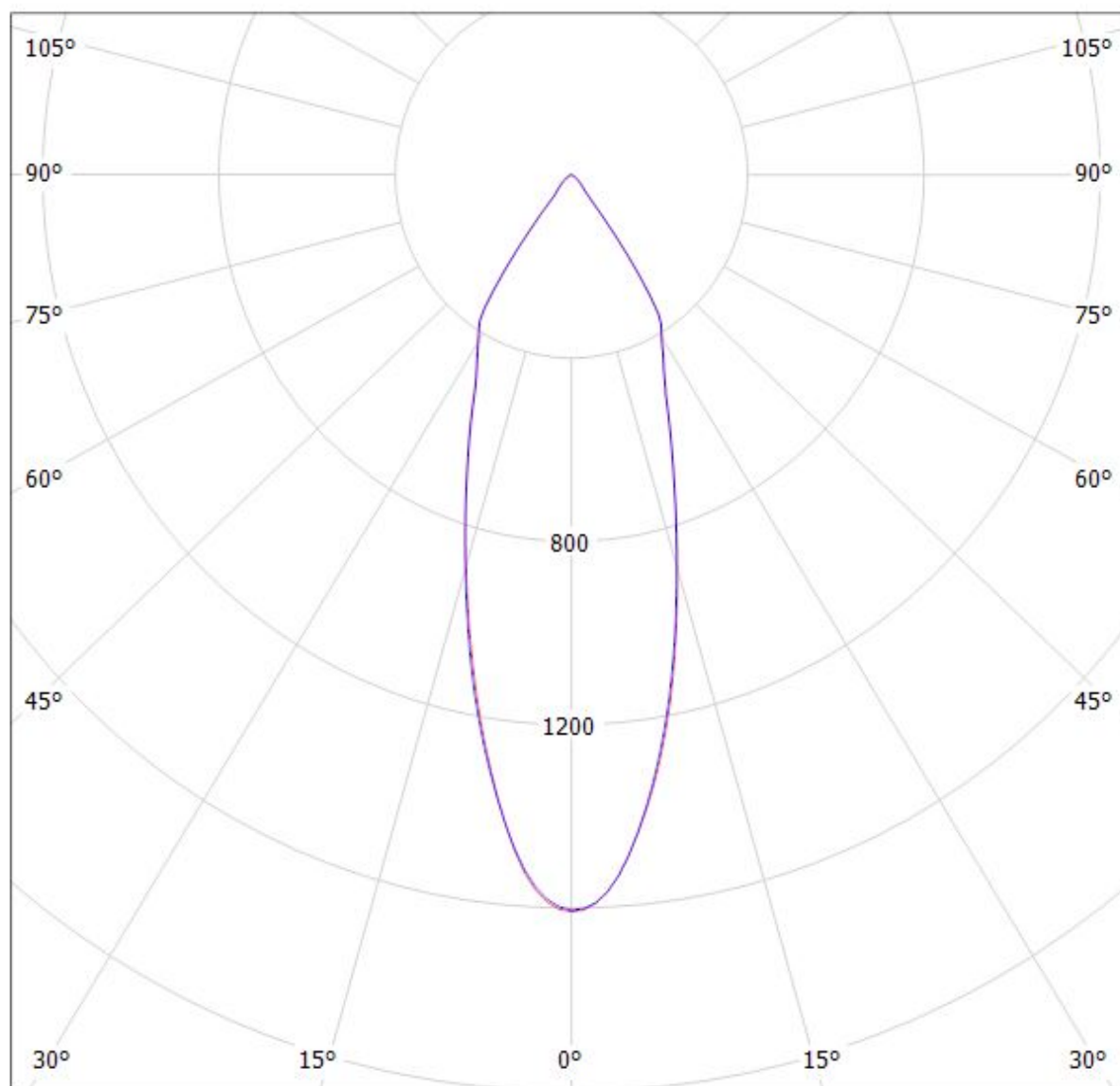

cd/klm

$\eta = 84\%$

— C0 - C180 — C90 - C270

Luminaire: LEDiL Oy F13381_ANGELA-W_(NSBxL121A)

Lamps: 1 x Nichia_NSBxL121A_914.478lm@250mA_P=7.56872W_I=249.9mA

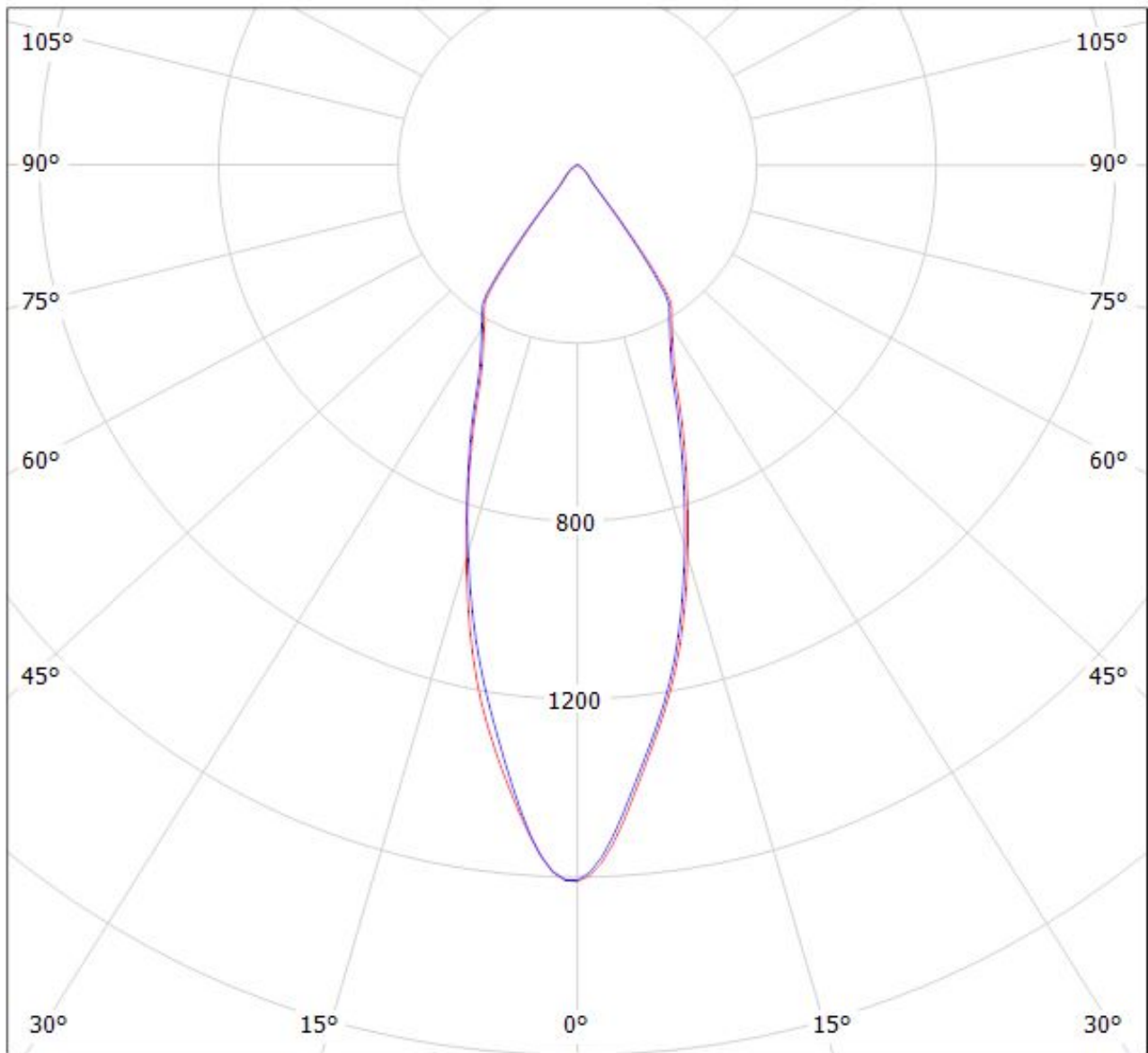

cd/klm

— C0 - C180

— C90 - C270

$\eta = 85\%$

Luminaire: LEDiL Oy F13381_ANGELA-W_(STARK_LES19)

Lamps: 1 x Tridonic_STARK_SLE_G3_LES19_(Stark-SLE-PURE-G3-19-2000-840-CLA)_1050.59lm@250mA_P=8.3639W_I=249.9mA

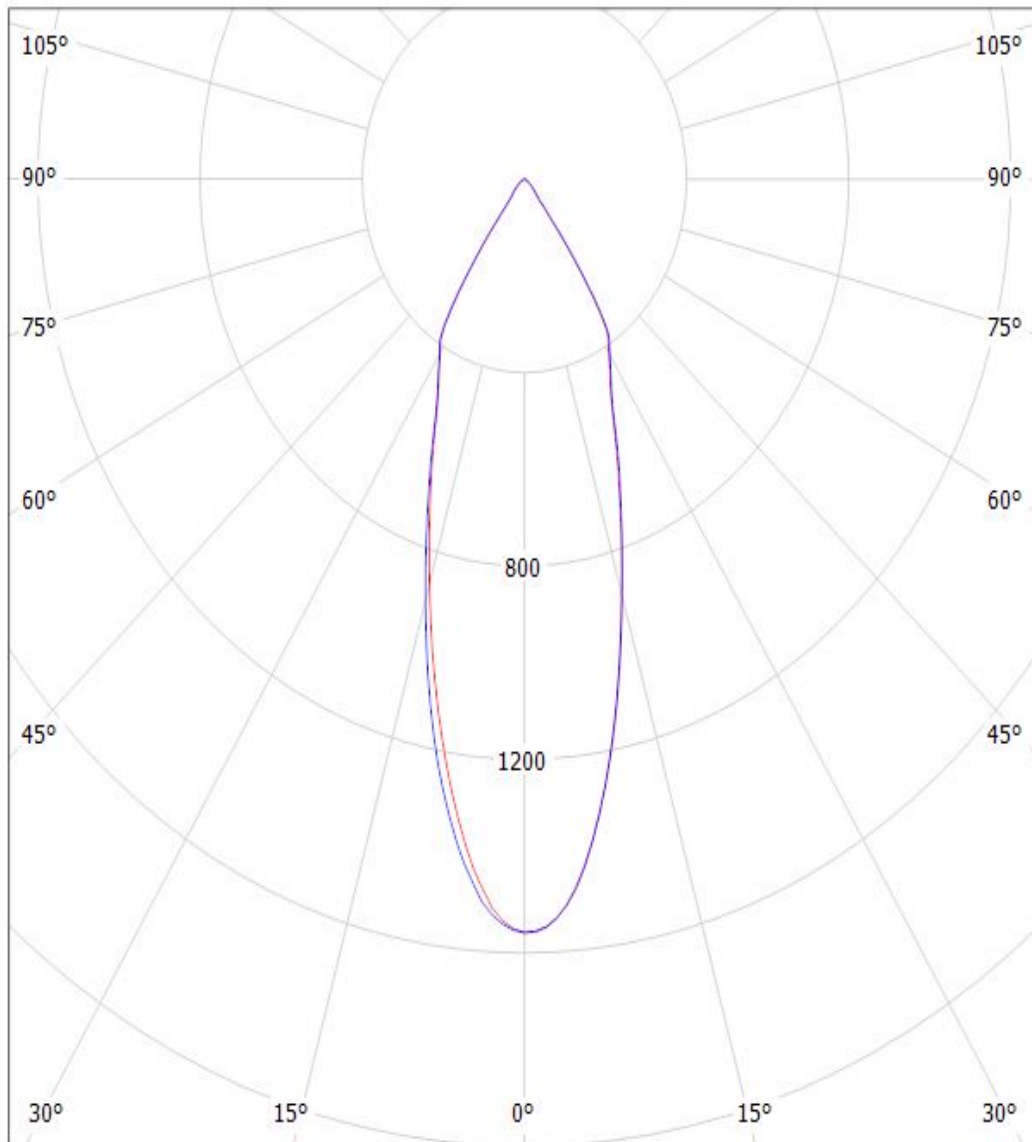

cd/klm

— C0 - C180 — C90 - C270

$\eta = 84\%$

Luminaire: LEDiL Oy F13381_ANGELA-W_(COB-LC026B) Eff.83.8%
Lamps: 1 x SAMSUNG_COB-LC026B_(SPHWWTHDNC25YHV52F)
_1122.94lm@250mA_P=8.2479W_I=249.8mA

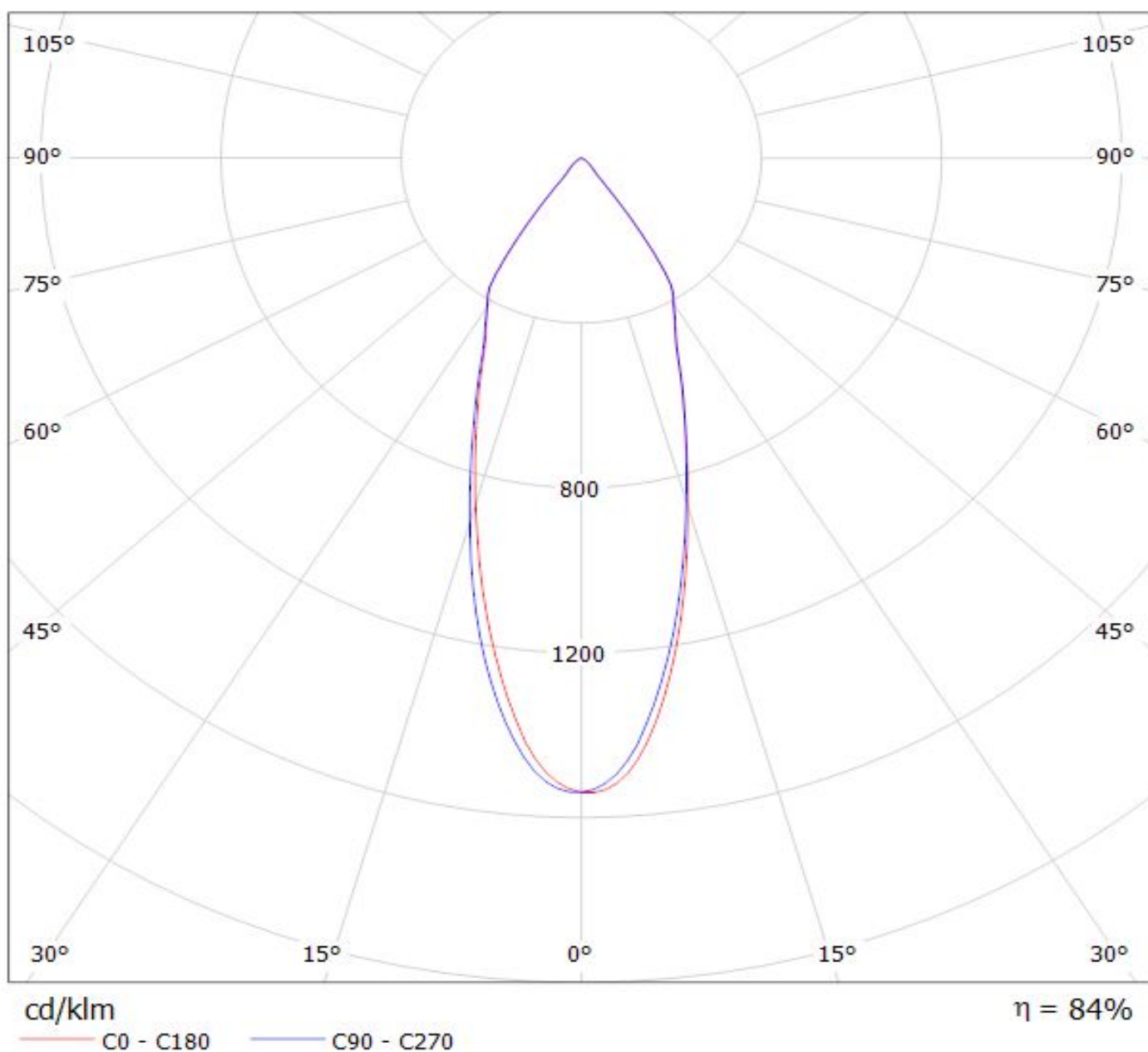

Luminaire: LEDiL F13381_ANGELA-W_(WU-M-461)
Lamps: 1 x Vossloh-Schwabe WU-M-461-827 767lm@250mA

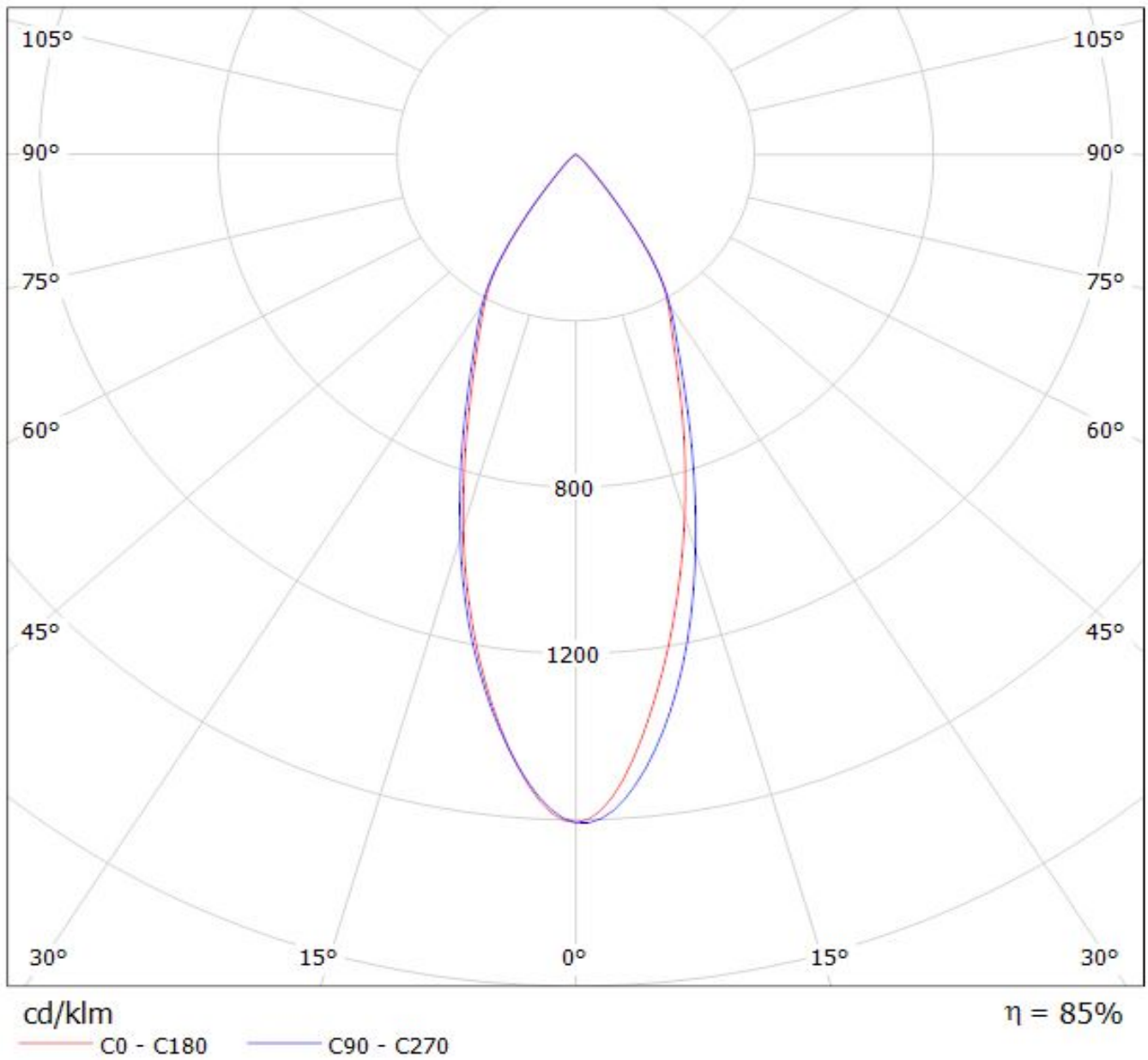

Luminaire: LEDiL Oy F13381_ANGELA-W_(WU-M-485)

Lamps: 1 x Vossloh_Schwabe-WU-M-485_(WU-M-485-830)_1209.62lm@250mA_P=8.43849W_I=249.8mA

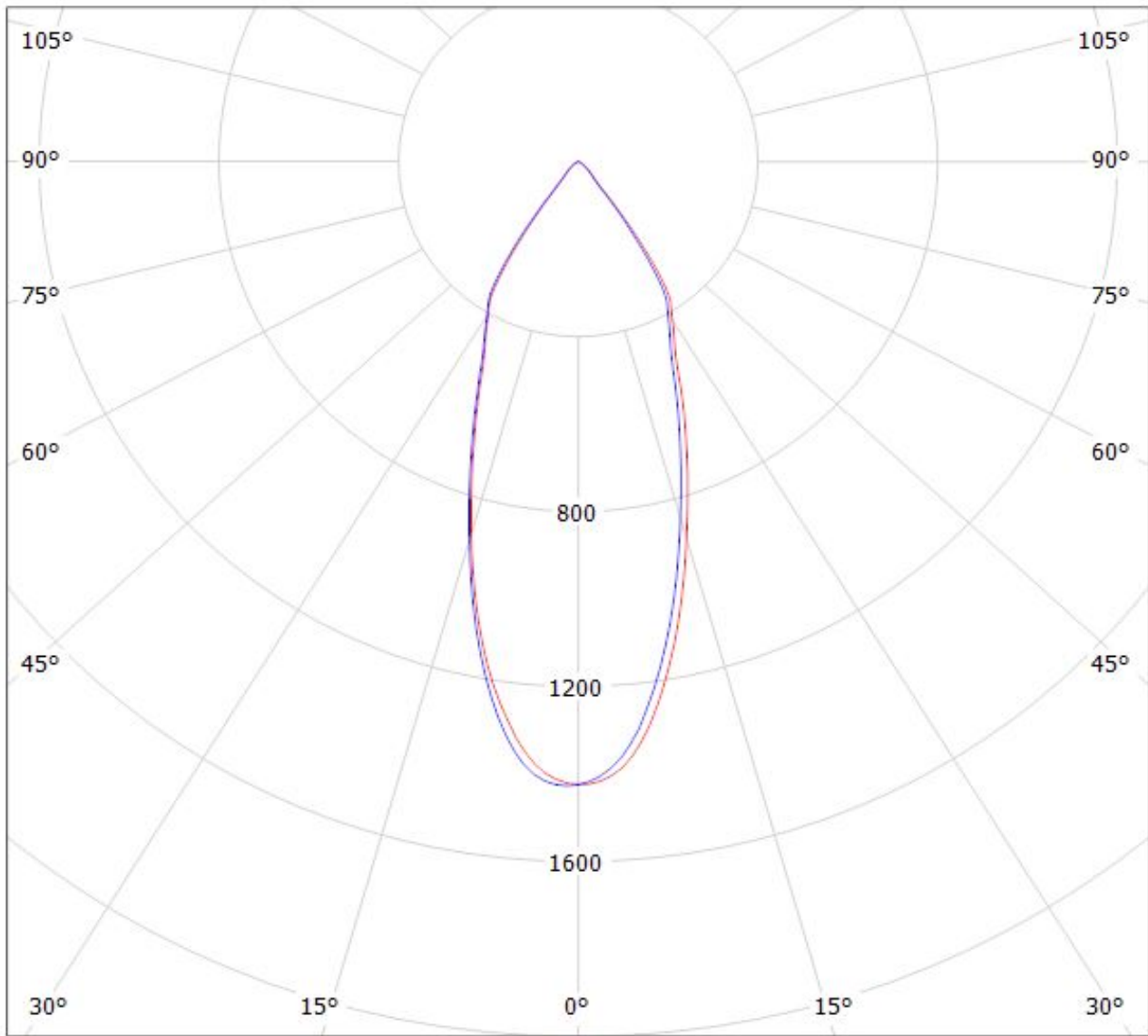

cd/klm

— C0 - C180

— C90 - C270

$\eta = 83\%$

Luminaire: LEDiL Oy F13381_ANGELA-W_(WU-M-486) Eff.83.2%
Lamps: 1 x Vossloh_Schwabe-WU-M-486_(WU-M-486-830)
_1474.55lm@250mA_P=10.4456W_I=249.8mA

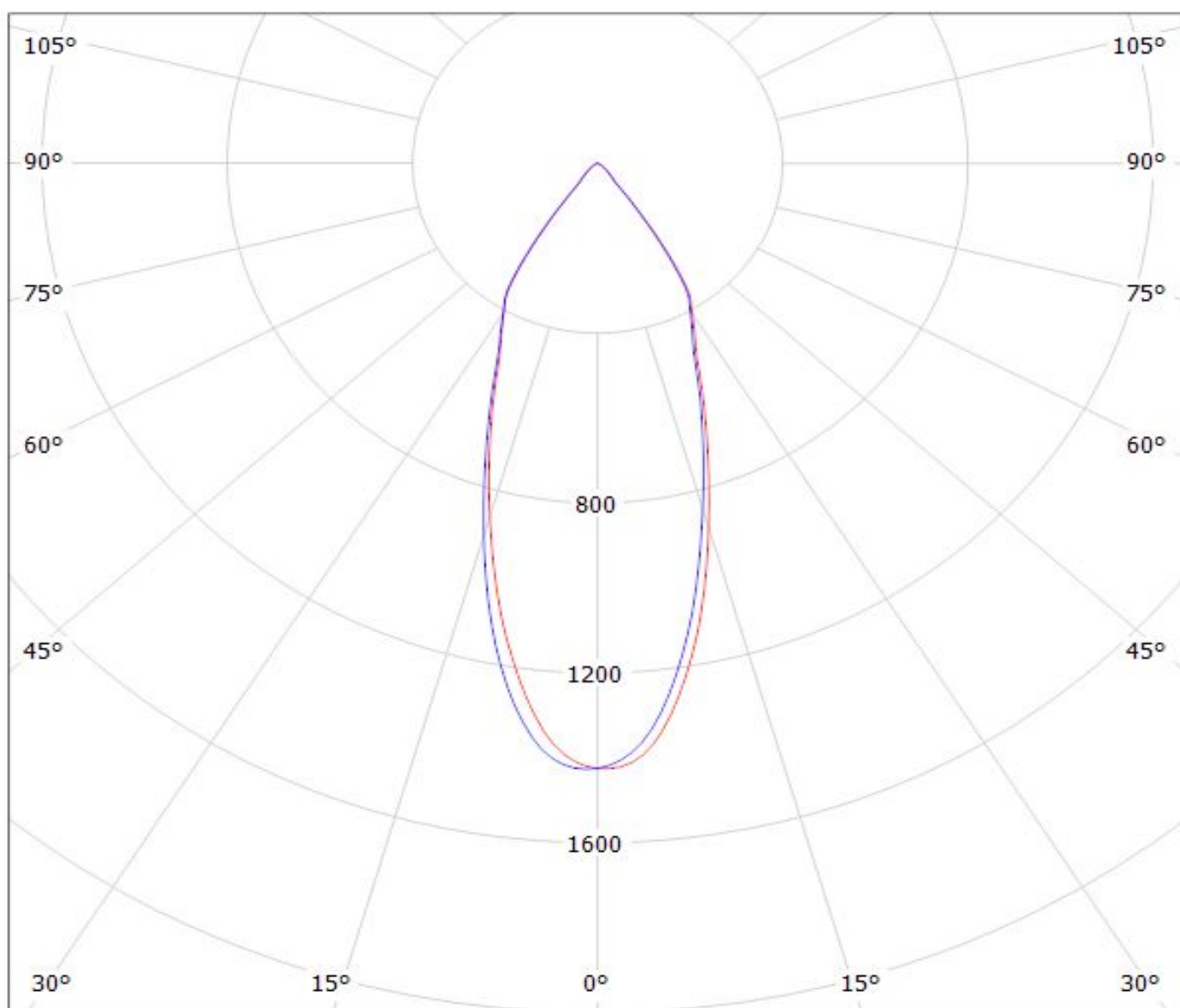

cd/klm

$\eta = 83\%$

— C0 - C180 — C90 - C270

Luminaire: LEDiL F13381_ANGELA-W_(WU-M-462)
Lamps: 1 x Vossloh-Schwabe WU-M-462-827 1140lm@250mA

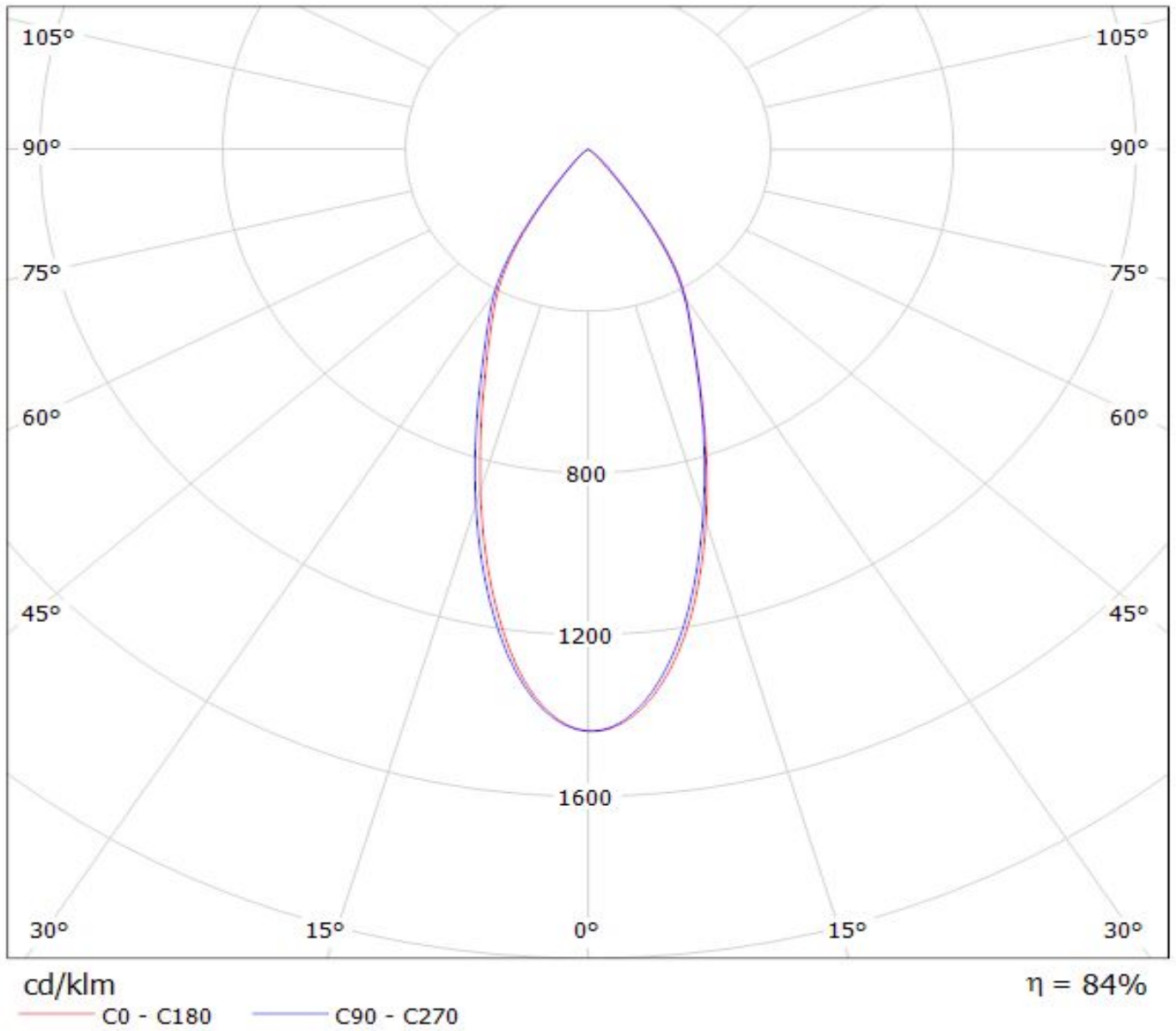

Luminaire: LEDiL F13381_ANGELA-W_(WU-M-464)
Lamps: 1 x Vossloh-Schwabe WU-M-464-827 1480lm@250mA

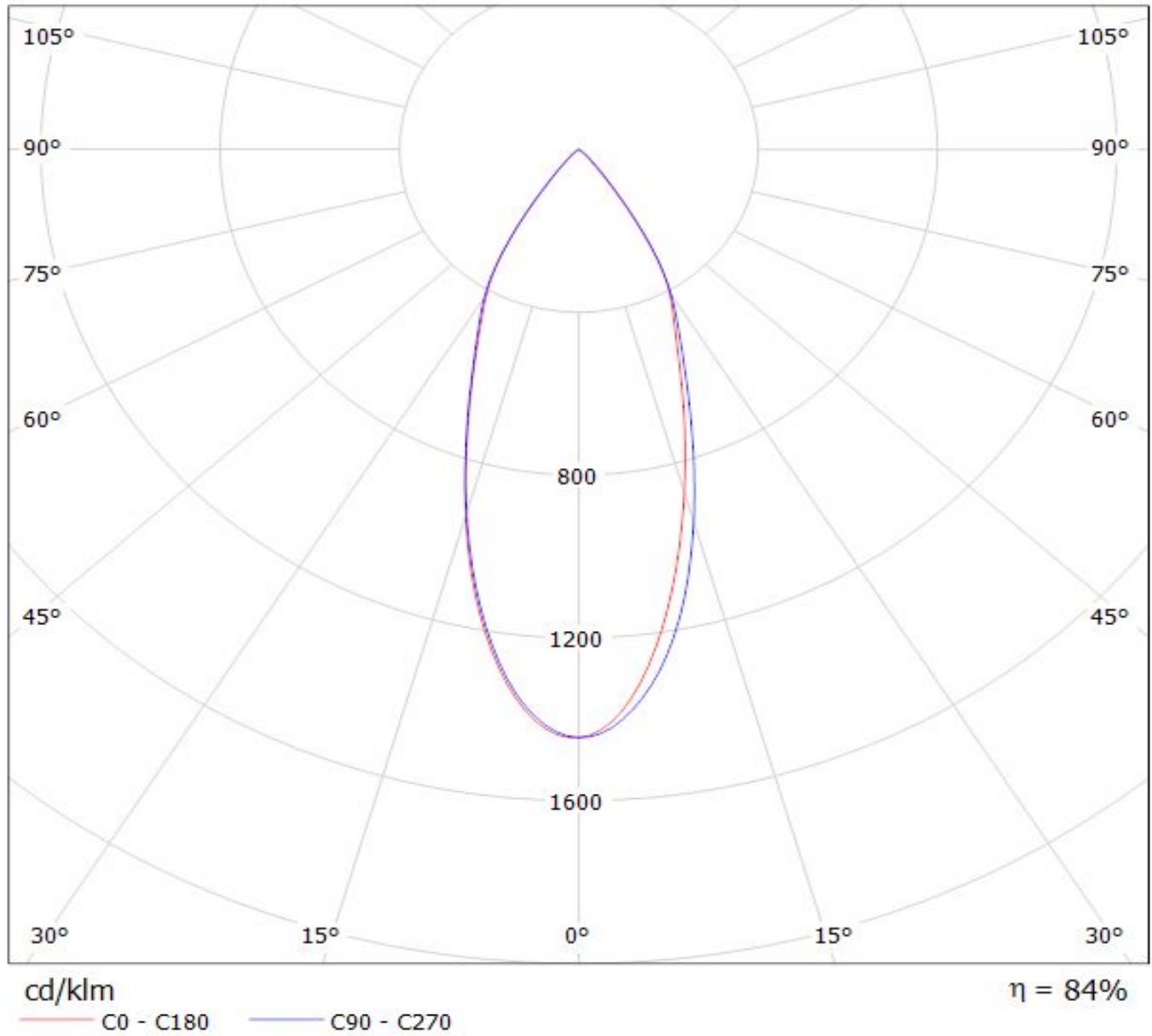

Luminaire: LEDiL Oy F13381_ANGELA-W_(CXA3590)

Lamps: 1 x CREE_CXA3590_(CXA3590-30F-BD-R0H-0002)_2640.14lm@250mA_CCT=3000K_P=16.3941W_I=249.8mA

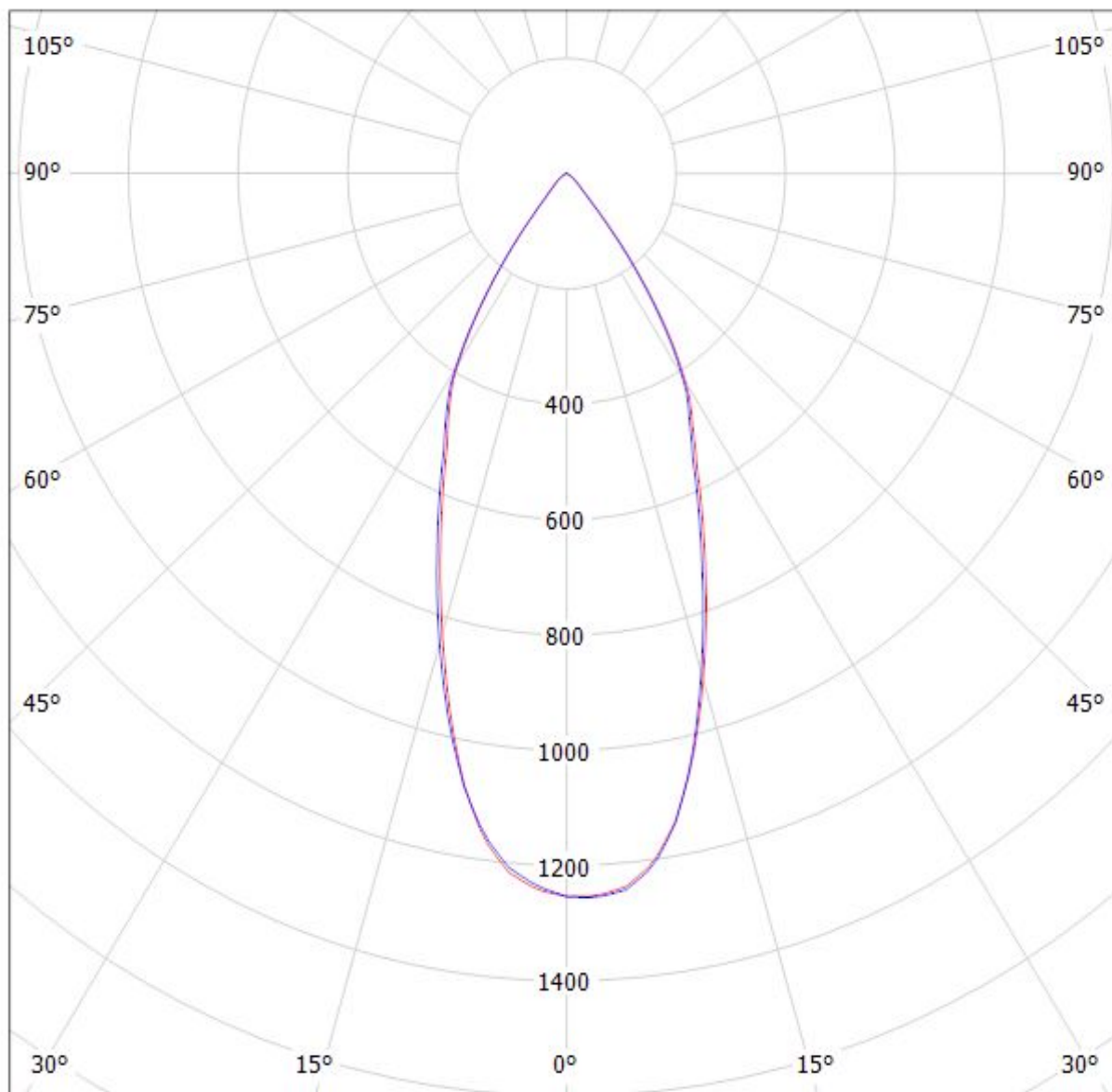

cd/klm

— C0 - C180

— C90 - C270

$\eta = 84\%$

NOTE: The typical divergence will be changed by different color, chip size and chip position tolerance. The typical total divergence is the full angle measured where the luminous intensity is half of the peak value.

GENERAL INFORMATION

- Product series especially designed & optimized for series of LEDs.
- Special care taken to make light distribution as uniform as possible.
- Reflector is made of aluminium coated PC (120 degrees of Celcius / 248 degrees of Fahrenheit) with protective lacquer (short term 100 degrees of Celcius / 212 degrees of Fahrenheit).

Note! Due to use of high power COB's with this product, special attention to proper thermal design is highly recommended. LEDiL has no liability for direct, indirect or consecutive damages arising from the LEDiL products being used outside of the recommended temperature range.