

DETAILS

Product Number	F13401_ANGELINA-M
Family	ANGELINA
Type	Reflector
Color	metal
Diameter	82 mm
Height	31 mm
Style	round
Optic Material	PC
Holder Material	
Fastening	
Status	ready
ROHS Compliant	Yes
Date Updated	13/06/2014



OPTICAL PROPERTIES

LED	Viewing Angle	Light Beam	Efficiency	cd/lm	connector
CXA1816/CXA1820/CXA1850	26 degrees		93 %	1.700	50-2101CR + Angela(50-2100AN) IDEAL
PrevaLED Core Z3 LES9	26 degrees		93 %	1.730	Z50 Optic Clip part n r. 2213194-1 TE
NSBxL121A/NFCxL060B	27 degrees		91 %	1.640	50-2100NC + Angela(50-2100AN) IDEAL
PrevaLED Core AC (LEP-800)	28 degrees		93 %	1.630	Z50 Optic Clip part n r. 2213194-1 TE
LUXEON CoB 1204/1205	28 degrees		92 %	1.610	50-2100SH + Angela(50-2100AN) IDEAL
COB 10W/13W/17W/24W	28 degrees		92 %	1.640	50-2100LG + Angela(50-2100AN) IDEAL
LUXEON K12	29 degrees		94 %	1.600	Solderless connector part nr. 2213134-2 + Z50
Optic Clip part n r. 2213194-1 TE	30 degrees		93 %	1.570	50-2100BL + Angela(50-2100AN) IDEAL
Mega Zenigata (GW6DME)	30 degrees		93 %	1.530	50-2100SH + Angela(50-2100AN) IDEAL
LUXEON CoB 1204/1205	30 degrees		94 %	1.800	Solderless connector part nr. 2213130-2 + Z50
Optic Clip part n r. 2213194-1 TE	30 degrees		92 %	1.550	50-2103CT + Angela(50-2100AN) IDEAL
LUXEON CoB 1208	31 degrees		93 %	1.500	50-2100SH + Angela(50-2100AN) IDEAL
NSCxJ216A/NFDxJ136B/NFCxJ108B	31 degrees		94 %	1.520	50-2103NC + Angela(50-2100AN) IDEAL



PRODUCT DATASHEET
ANGELINA series
last update 11/7/2014

LUXEON K16

32 degrees

94 %

1.500

Solderless connector



PRODUCT DATASHEET
ANGELINA series
last update 11/7/2014

Optic Clip part nr. 2213194-1 TE

part nr. 2213134-2 + Z50



PRODUCT DATASHEET
ANGELINA series
last update 11/7/2014

Mega Zenigata (GW6DME)

32 degrees

92 %

1.600

Solderless connector



PRODUCT DATASHEET
ANGELINA series
last update 11/7/2014

Optic Clip part nr. 2213194-1 TE

part nr. 2213130-2 + Z50



PRODUCT DATASHEET
ANGELINA series
last update 11/7/2014

LUXEON CoB 1208

32 degrees

93 %

1.600

Solderless connector



PRODUCT DATASHEET
ANGELINA series
last update 11/7/2014

Optic Clip part nr. 2213194-1 TE

part nr. 2213130-2 + Z50



PRODUCT DATASHEET
ANGELINA series
last update 11/7/2014

STARK SLE G2 LES19

33 degrees

92 %

1.500

Z50 Optic Clip part n



PRODUCT DATASHEET
ANGELINA series
last update 11/7/2014

r. 2213194-1 TE



PRODUCT DATASHEET
ANGELINA series
last update 11/7/2014

Soleriq S13

34 degrees

94 %

1.500

Solderless connector



PRODUCT DATASHEET
ANGELINA series
last update 11/7/2014

Optic Clip part nr. 2213194-1 TE

part nr. 2213401-2 + Z50



PRODUCT DATASHEET
ANGELINA series
last update 11/7/2014

CXM-14

34 degrees

93 %

1.380

TE: Solderless connec



PRODUCT DATASHEET
ANGELINA series
last update 11/7/2014

Optic Clip part nr. 2213194-1 TE

tor part nr 2213254-2 + Z50



PRODUCT DATASHEET
ANGELINA series
last update 11/7/2014

PrevaLED Core Z4 LES19

34 degrees

93 %

1.400

Z50 Optic Clip part n



PRODUCT DATASHEET
ANGELINA series
last update 11/7/2014

r. 2213194-1 TE



PRODUCT DATASHEET
ANGELINA series
last update 11/7/2014

CXA25xx

34 degrees

93 %

1.370

50-2102CR + Angela(50



PRODUCT DATASHEET
ANGELINA series
last update 11/7/2014

-2100AN) IDEAL



PRODUCT DATASHEET
ANGELINA series
last update 11/7/2014

Fortimo SLM 2000 G3

35 degrees

90 %

1.500

Z50 Optic Clip part n



PRODUCT DATASHEET
ANGELINA series
last update 11/7/2014

r. 2213194-1 TE



PRODUCT DATASHEET
ANGELINA series
last update 11/7/2014

Fortimo SLM 3000 G3

35 degrees

90 %

1.500

Z50 Optic Clip part n



PRODUCT DATASHEET
ANGELINA series
last update 11/7/2014

r. 2213194-1 TE



PRODUCT DATASHEET
ANGELINA series
last update 11/7/2014

CLL03x/CLU034

35 degrees

94 %

1.400

TE: Solderless connec



PRODUCT DATASHEET
ANGELINA series
last update 11/7/2014

Optic Clip part nr. 2213194-1 TE

tor part nr 2213254-2 + Z50



PRODUCT DATASHEET
ANGELINA series
last update 11/7/2014

WU-M-461

35 degrees

93 %

1.350

Z50 Optic Clip part n



PRODUCT DATASHEET
ANGELINA series
last update 11/7/2014

r. 2213194-1 TE

D

C

B

A

4

4

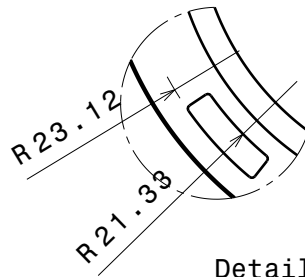
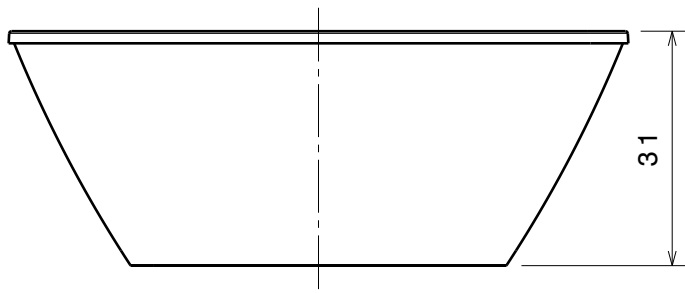

Detail B
Scale: 2:1

3

3

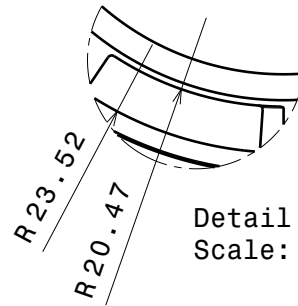
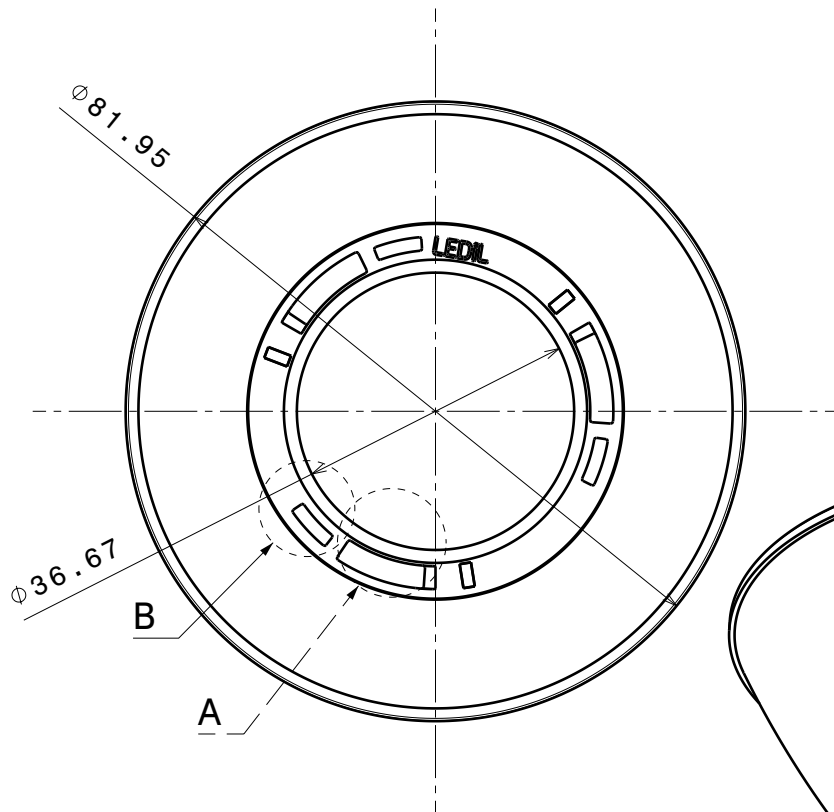

Detail A
Scale: 2:1

2

2

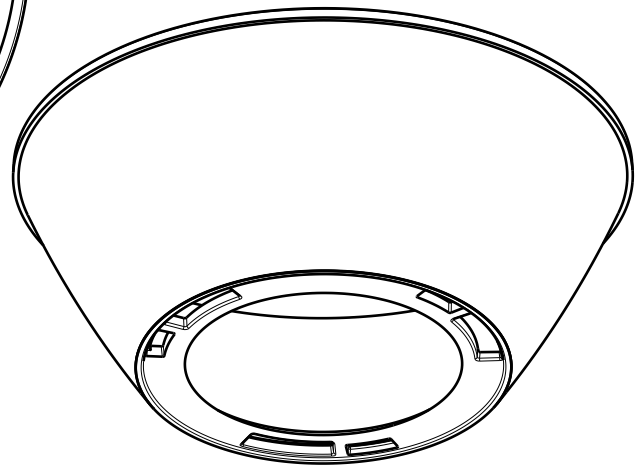

1

1

INDEX	PART NO	DESCRIPTION	MATERIAL	COLOUR
1		ANGELINA	PC	metal

Tolerances if not otherwise shown
According to DIN ISO 2768-1
Linear measures:
Up to 30mm class F, otherwise class M.
According to DIN ISO 2768-2
Form and position: class K



Ledil Oy
Salorankatu 10
FIN 24240 SALO
Finland

THIRD ANGLE PROJECTION:

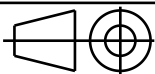

DRAWING TITLE

ANGELINA series Reflector

This drawing is the property of LEDiL Oy. It may not be reproduced, copied or communicated without a written agreement with LEDiL Oy."

SIZE PART NUMBER

A4

-

SCALE 1:1 WEIGHT

-

SHEET 1/1

D

A

Luminaire: LEDiL Oy F13401_ANGELINA-M_(CXA1816) Eff. 93%
Lamps: 1 x CREE_CXA1816_1042.78lm@250mA_P=8.65157W_I=249.9mA

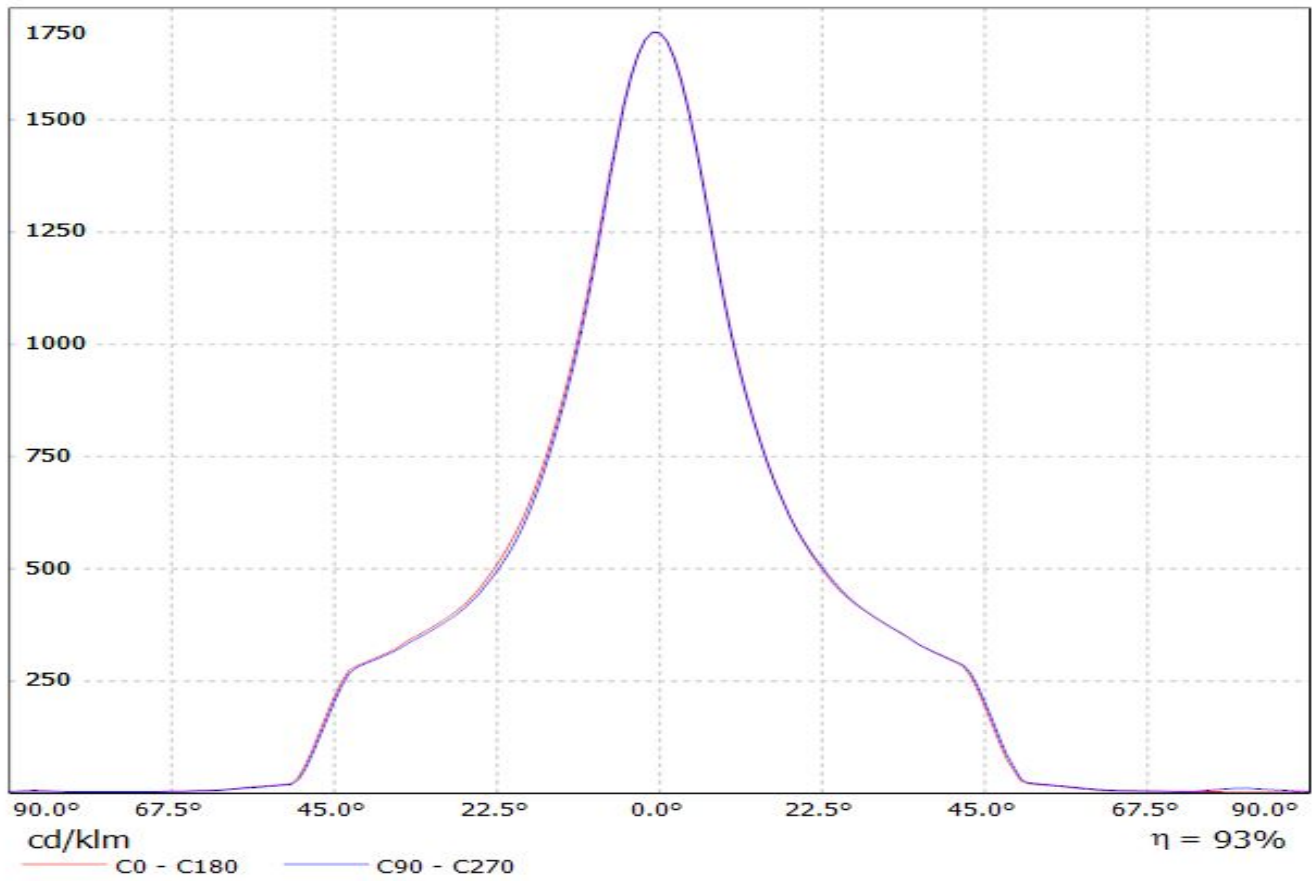

Luminaire: LEDiL Oy F13401_ANGELINA-M_(PrevaLED_LES9) Eff.93%

Lamps: 1 x OSRAM PrevaLED_LES9_(PL-CORE-1100-830-Z3)_507.9lm@100mA_P=4.5039W_I=100.1mA

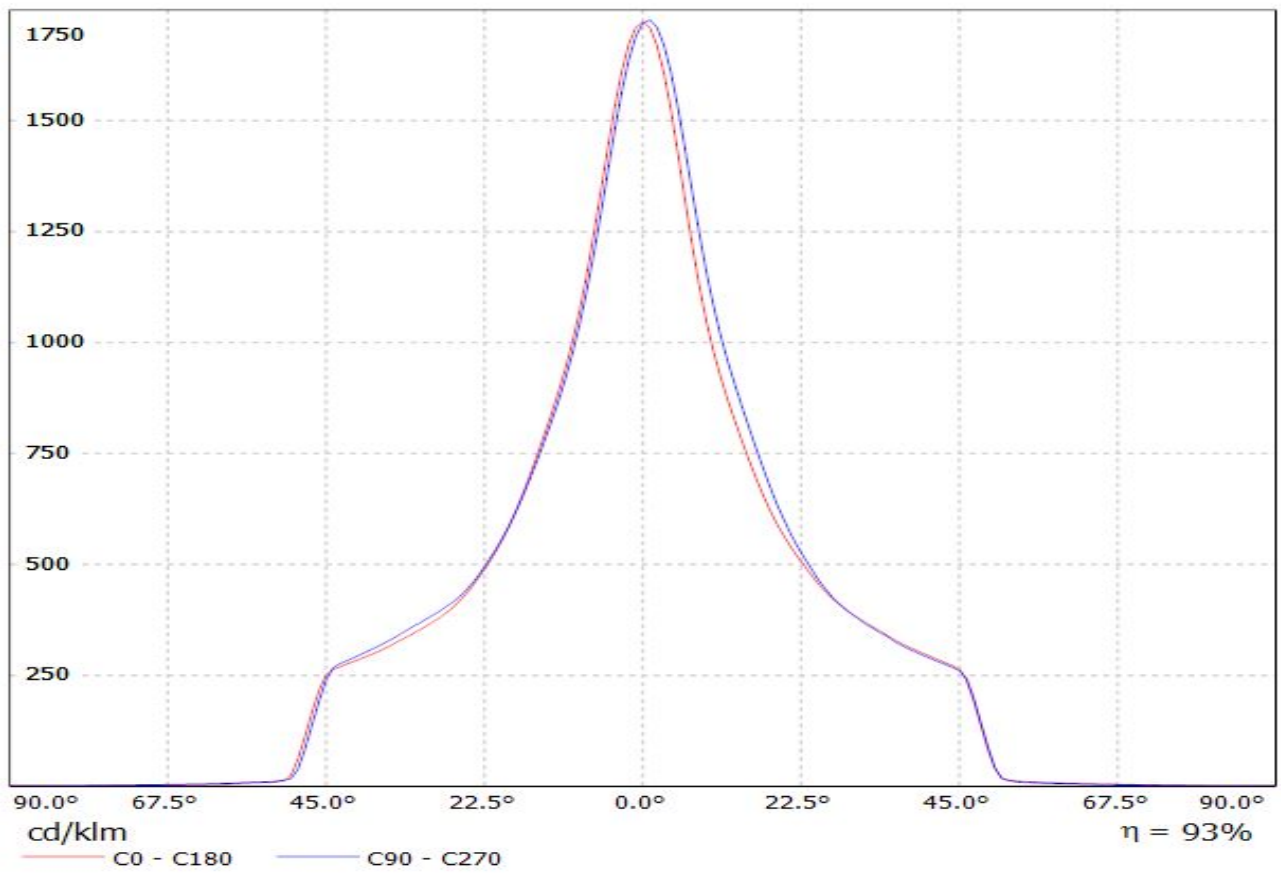

Luminaire: LEDiL Oy F13401_ANGELINA-M_(NSBxL121A) Eff.90.8%
Lamps: 1 x NICHIA_NSBxL121A_(NSBLL121AE)_805.561lm@250mA_CCT=3000K_P=7.3681W_I=249.8mA

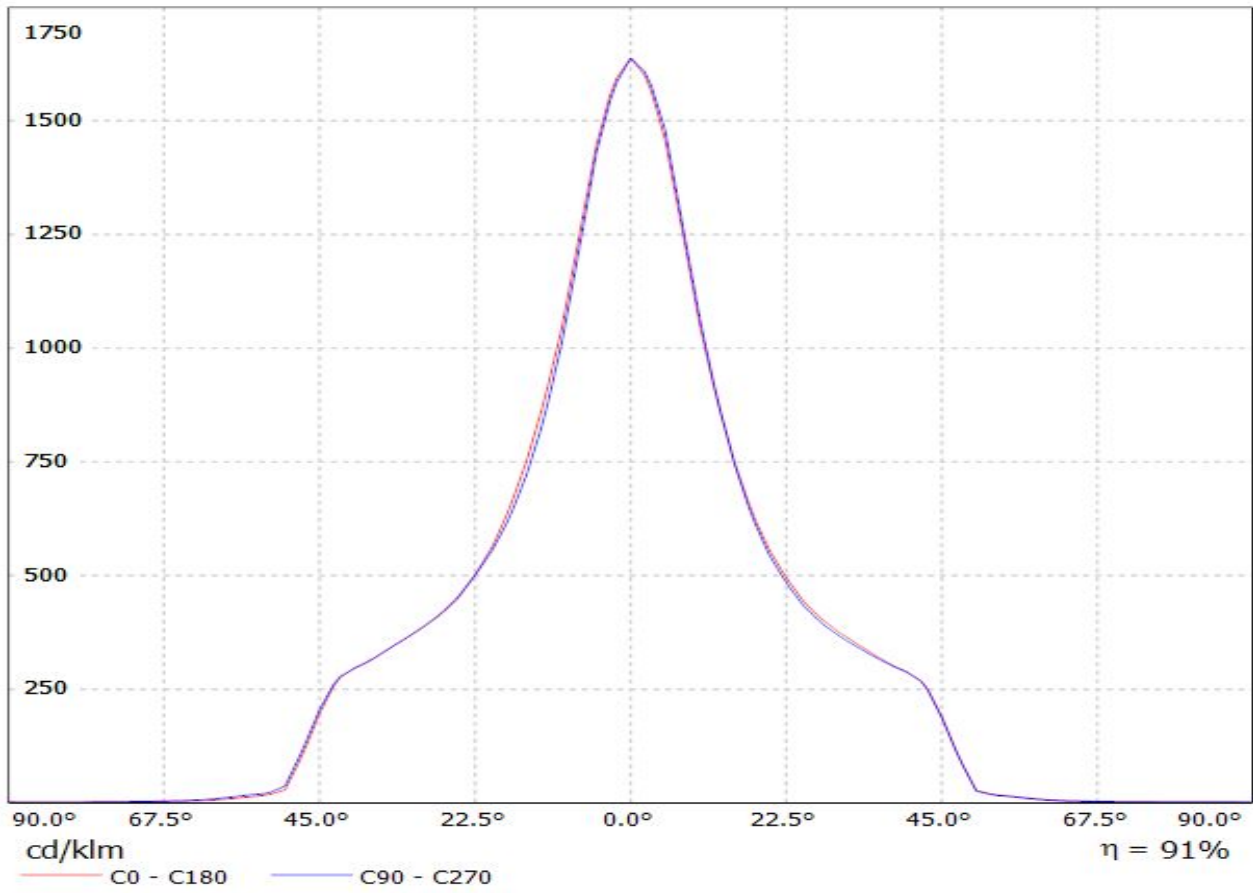

Luminaire: LEDiL Oy F13401_ANGELINA-M (LEP-800-827-C-AC)

Lamps: 1 x OSRAM PrevaLED Core AC (LEP-800-827-C-AC) 910lm@60mA U:230V P:14W

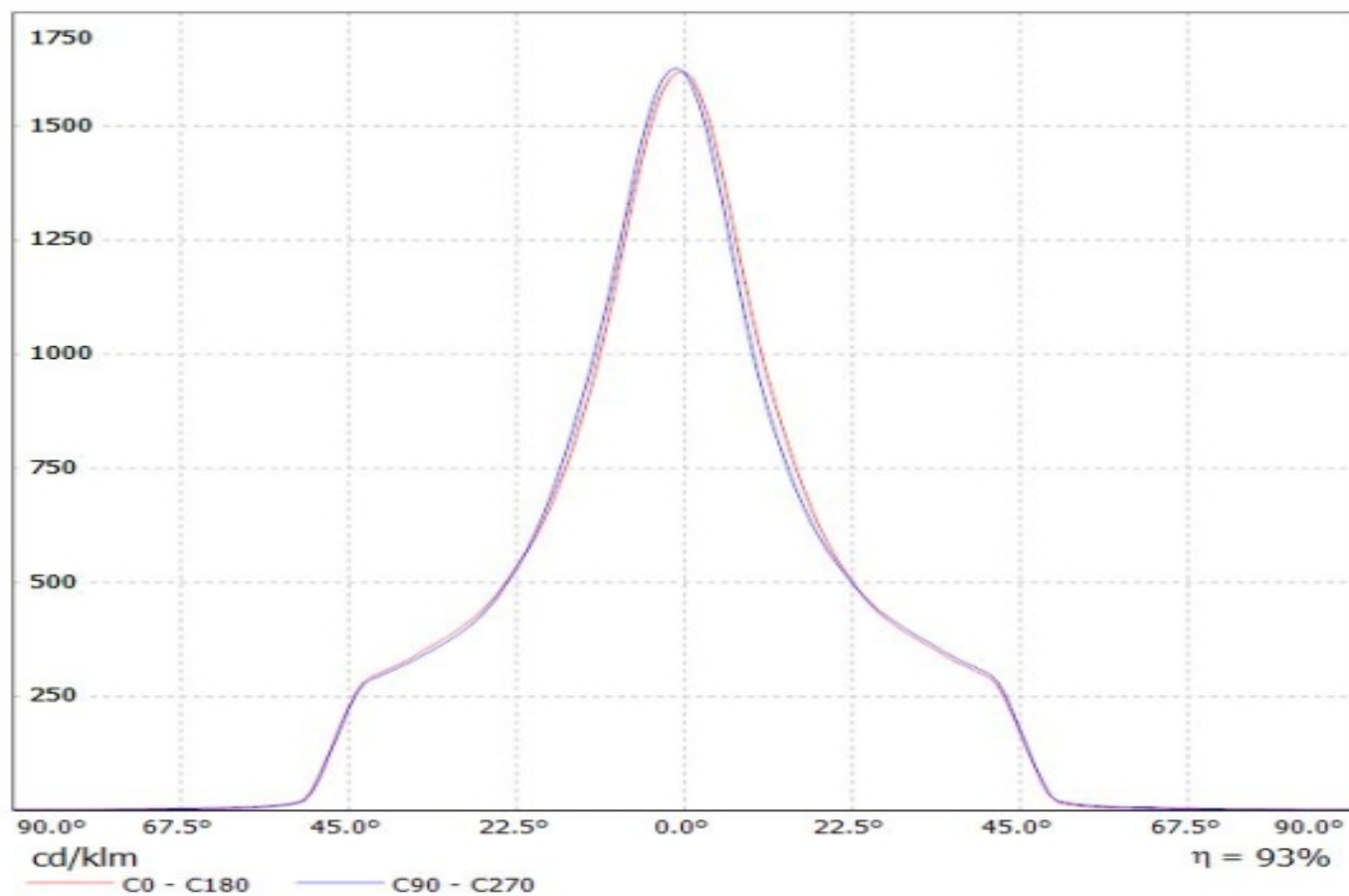

Luminaire: LEDiL Oy F13401_ANGELINA-M_(LUXEON_COB_1205) Eff.92.4%
Lamps: 1 x LUXEON_COB_1205_(LHC1-3080-1205)_1084.49lm@250mA_CCT=3000K_P=8.31784W_I=249.8mA

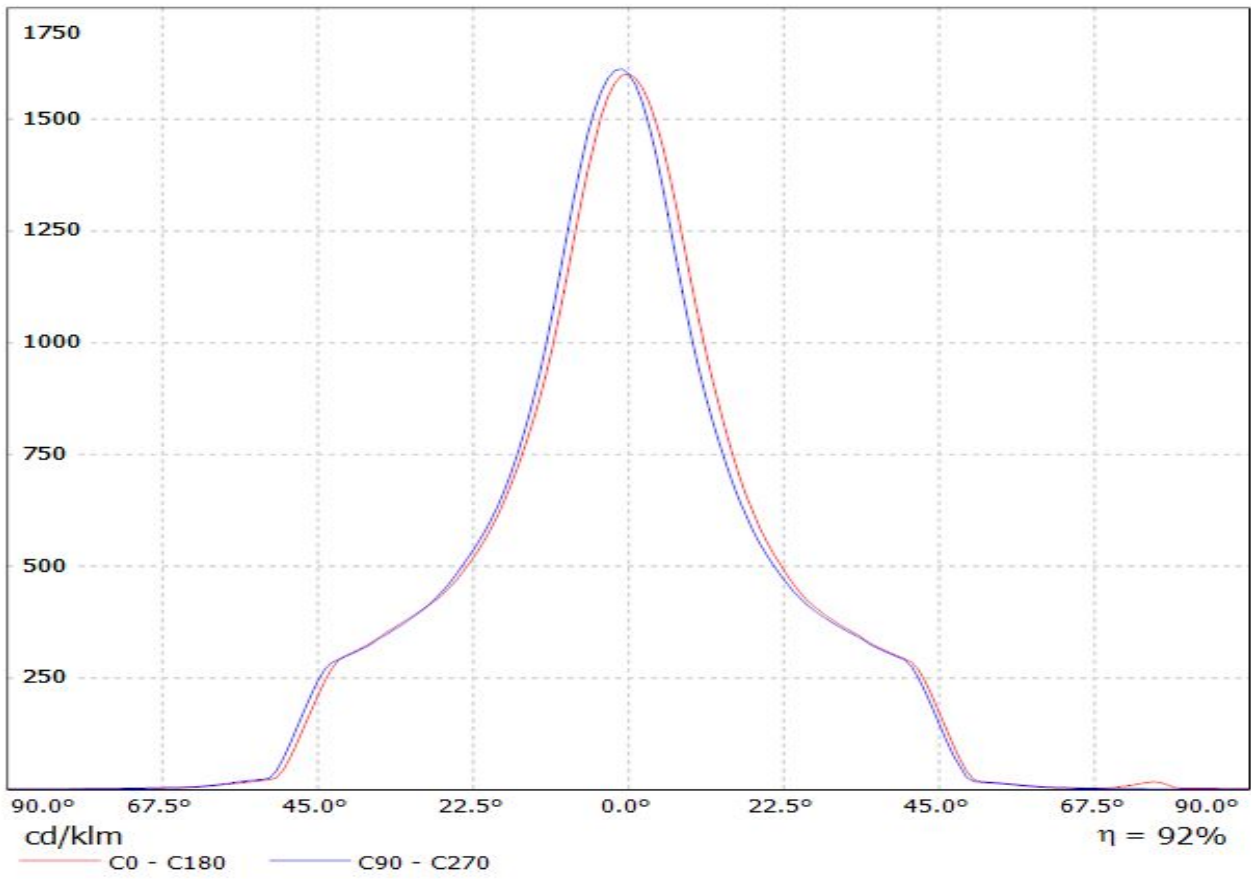

Luminaire: LEDiL Oy F13401_ANGELINA-M_(LG_COB-10W) Eff.92.4%
Lamps: 1 x LG_COB-10W_1024lm@250mA_CCT=5090K_P=9W_I=250mA

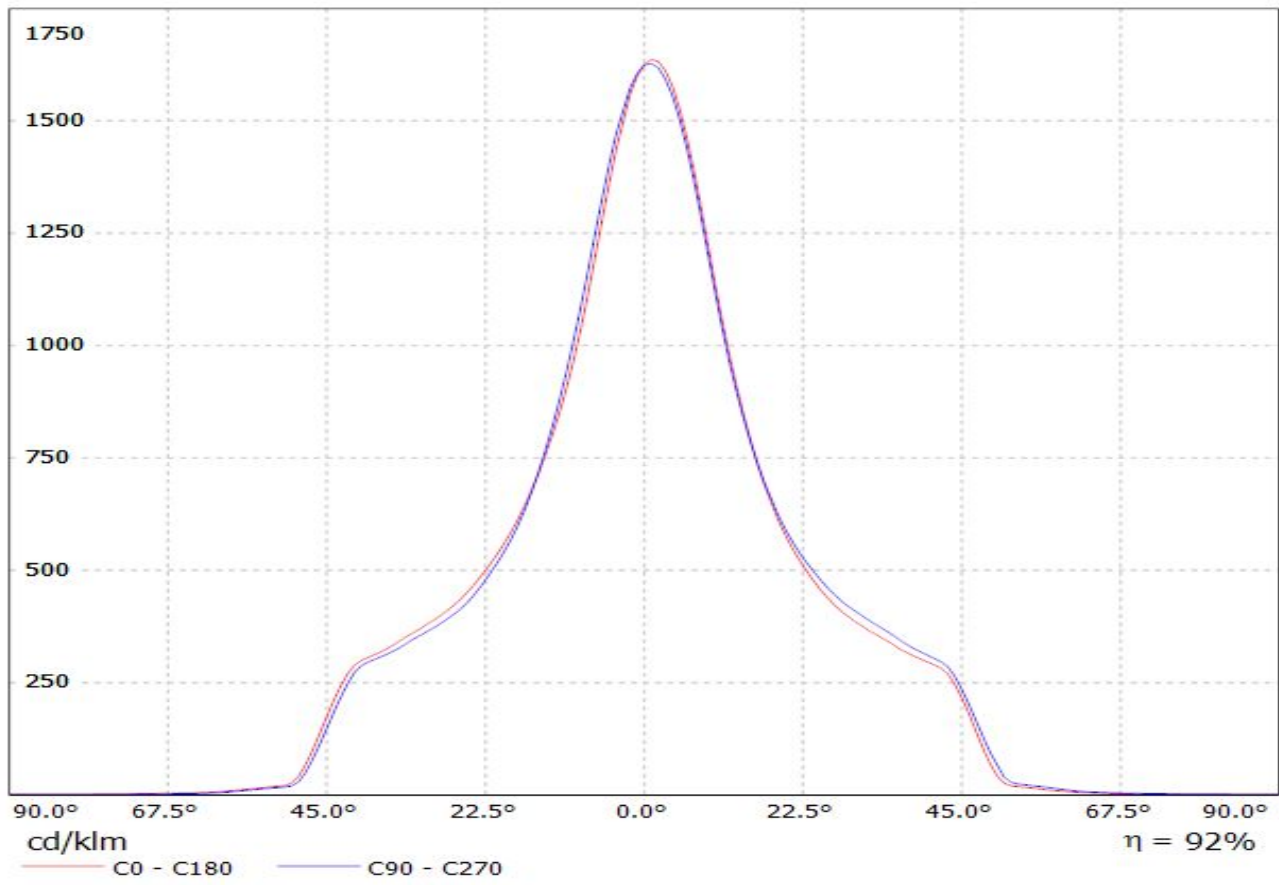

LEDiL Oy C13401_ANGELINA-M_(LUXEON_K12) Eff.94.0% / LDC (Linear)

Luminaire: LEDiL Oy C13401_ANGELINA-M_(LUXEON_K12) Eff.94.0%
Lamps: 1 x LUXEON_K12 (929.543lm@250mA)

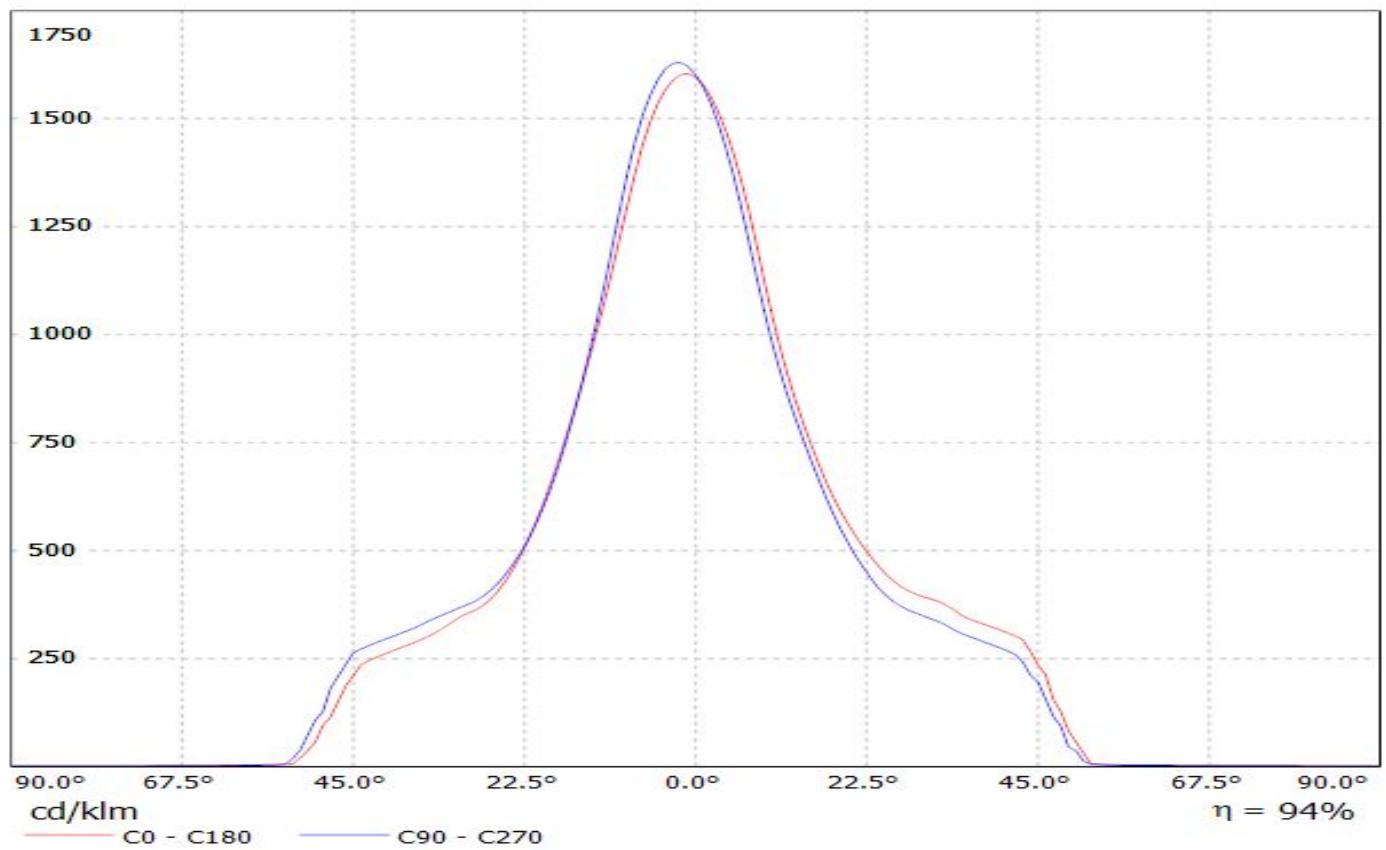

Luminaire: LEDiL Oy F13401_ANGELINA-M_(BXRA_ES) Eff.92.6%

Lamps: 1 x BXRA_ES_(BXRA-W1203_102820-3110)_281.549lm@250mA_P=4.09397W_I=249.8mA

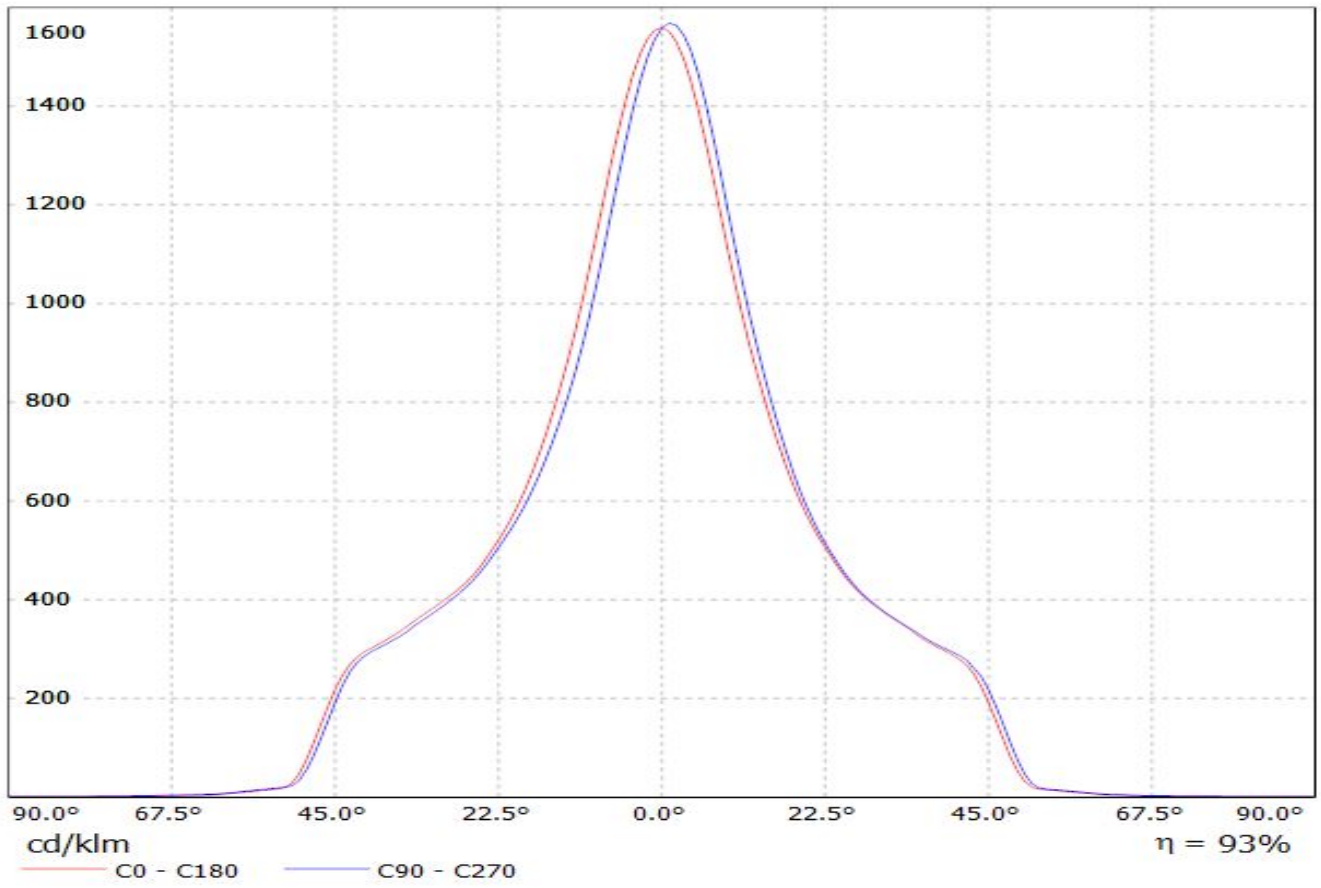

Luminaire: LEDiL Oy F13401_ANGELINA-M_(MEGAZENIGATA) Eff.92.5%
Lamps: 1 x SHARP_MEGAZENIGATA_(GW6DME30NFC)_1238.26lm@250mA_CCT=3000K_P=11.1211W_I=249.8mA

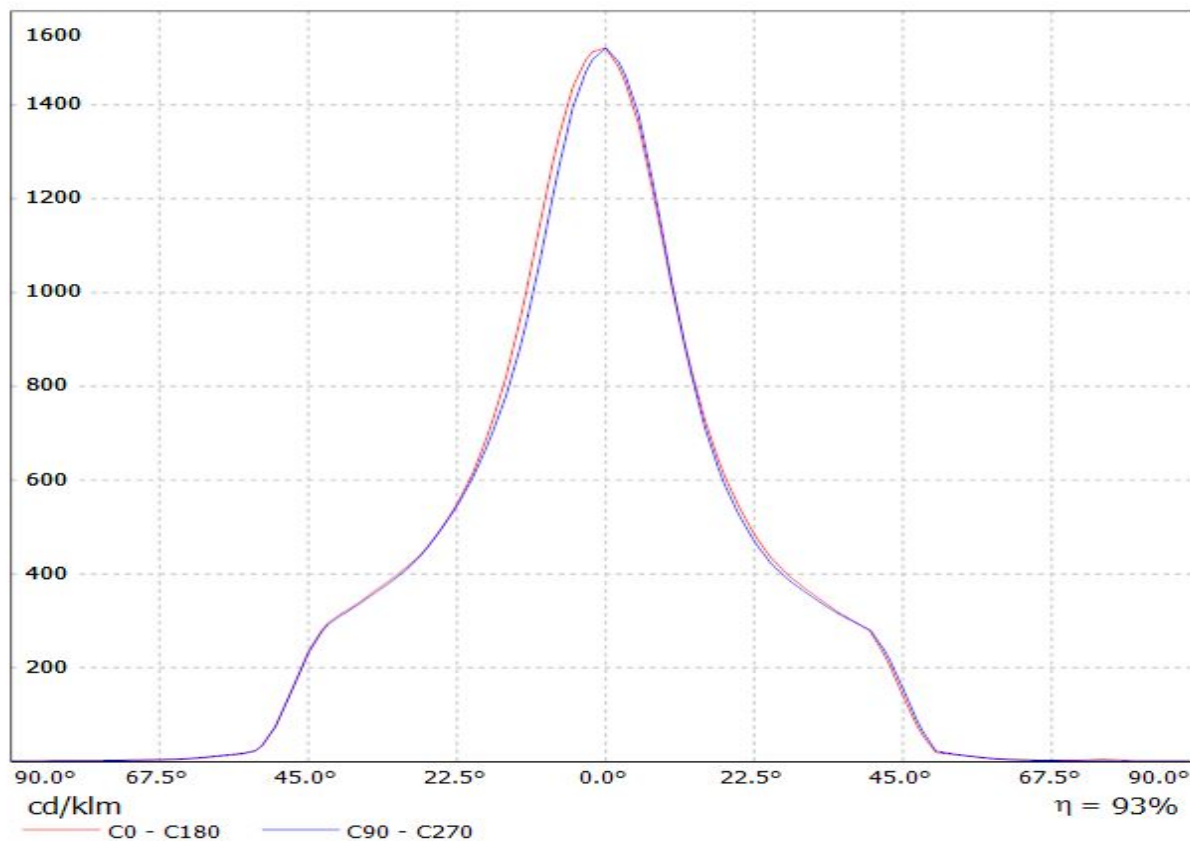

Luminaire: LEDiL Oy F13401_ANGELINA-M_(LUXEON_CoB_1205) Eff. 94 %
Lamps: 1 x LUXEON CoB 1205 (LHC1-3080-1205) 1082lm@250mA CCT=3000K P=8.3W I=250mA

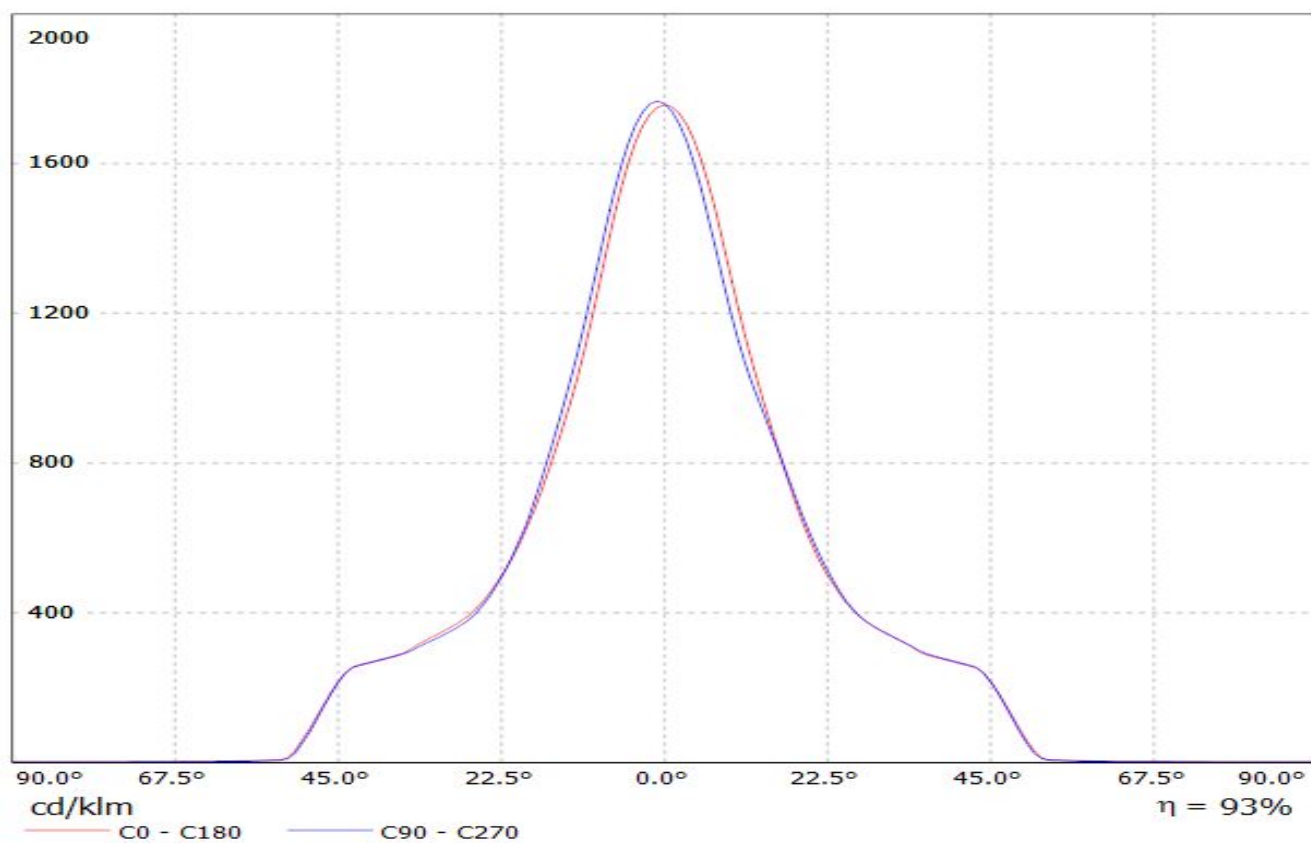

Luminaire: LEDiL Oy F13401_ANGELINA-M_(CLL030) Eff.92.3%

Lamps: 1 x CITIZEN_CLL030_(CLL030-1205A5-303H1A7)_758.588lm@250mA_CCT=5090K_P=8.61086W_I=249.8mA

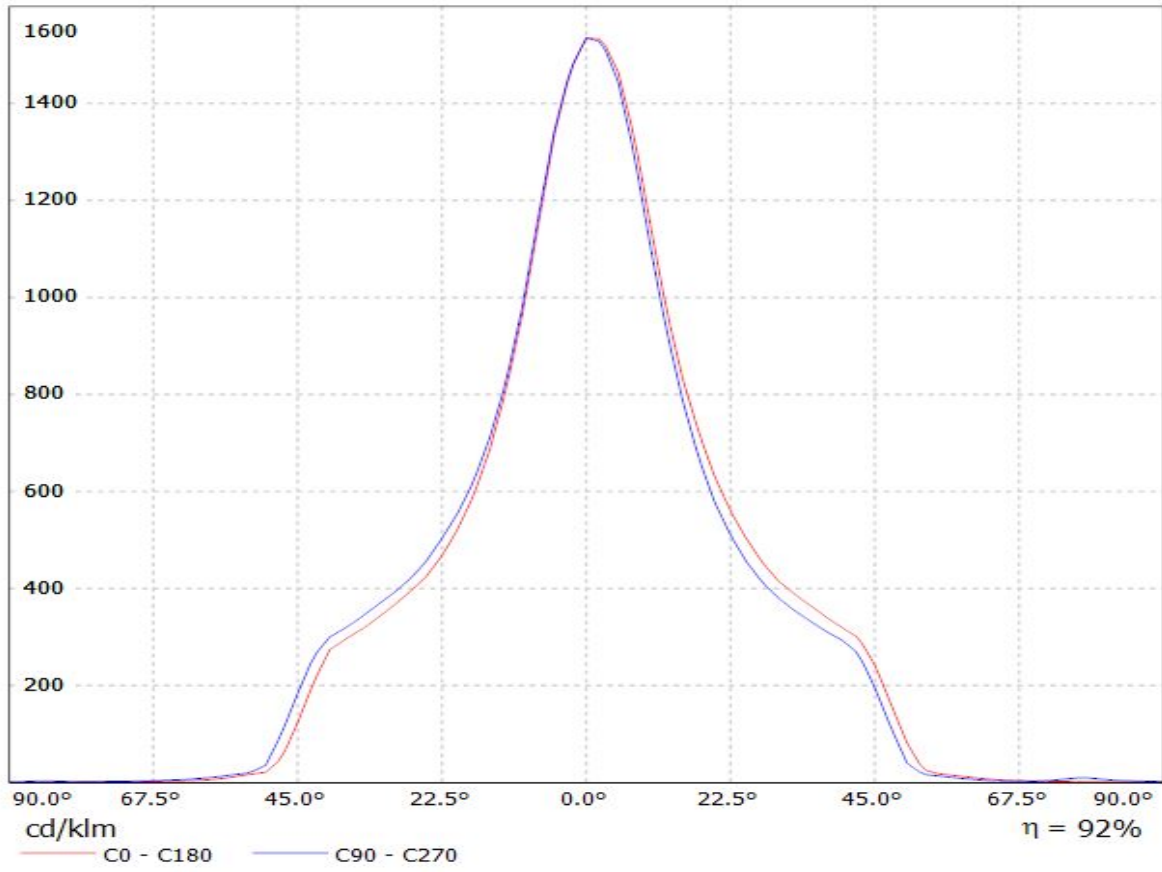

Luminaire: LEDiL Oy F13401_ANGELINA-M_(LUXEON_COB_1208) Eff.92.5%
Lamps: 1 x LUXEON_COB_1208_(LHC1-3080-1208)_1015.13lm@250mA_CCT=3000K_P=8.15972W_I=249.8mA

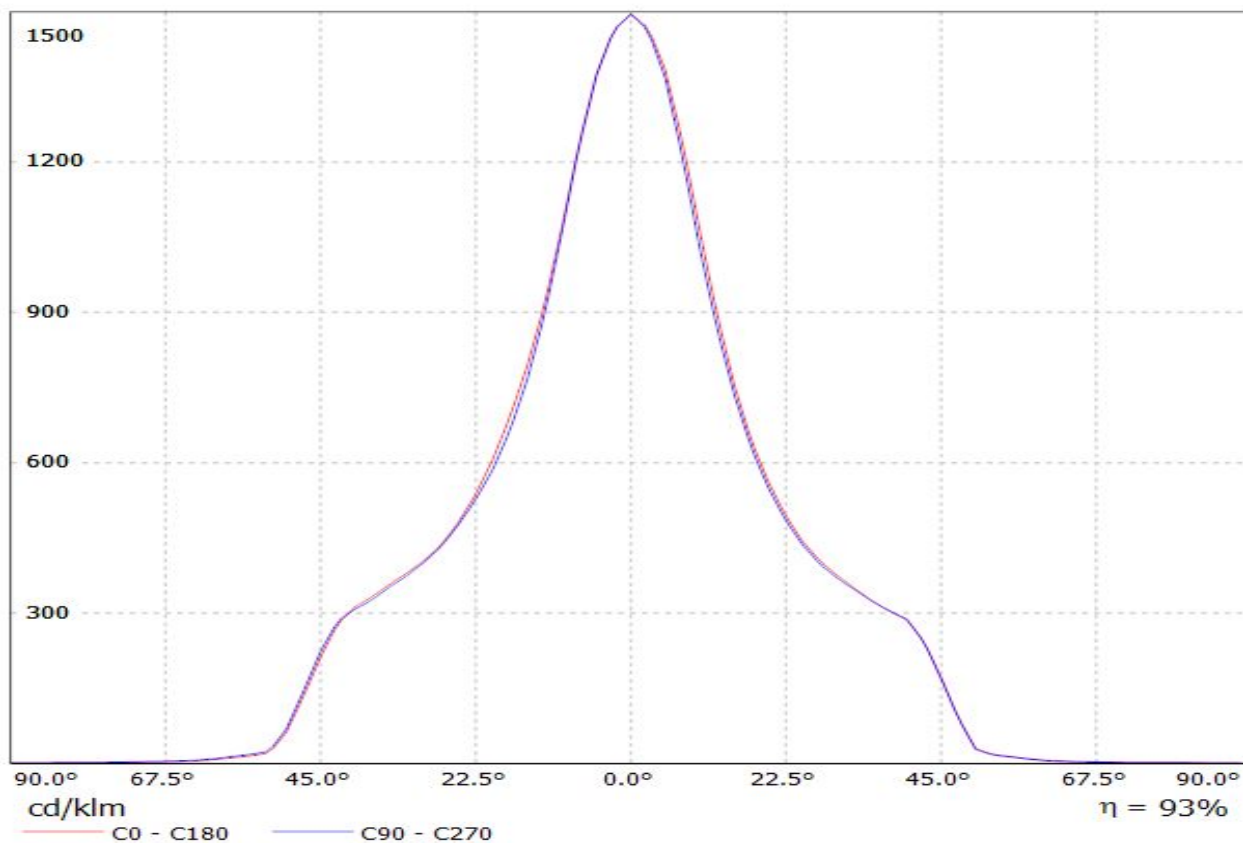

Luminaire: LEDiL Oy F13401_ANGELINA-M_(NSCxJ216A) Eff.93.5%
Lamps: 1 x NICHIA_NSCxJ216A_(NSCLJ216AE)_949.847lm@250mA_CCT=3000K_P=7.96937W_I=249.8mA

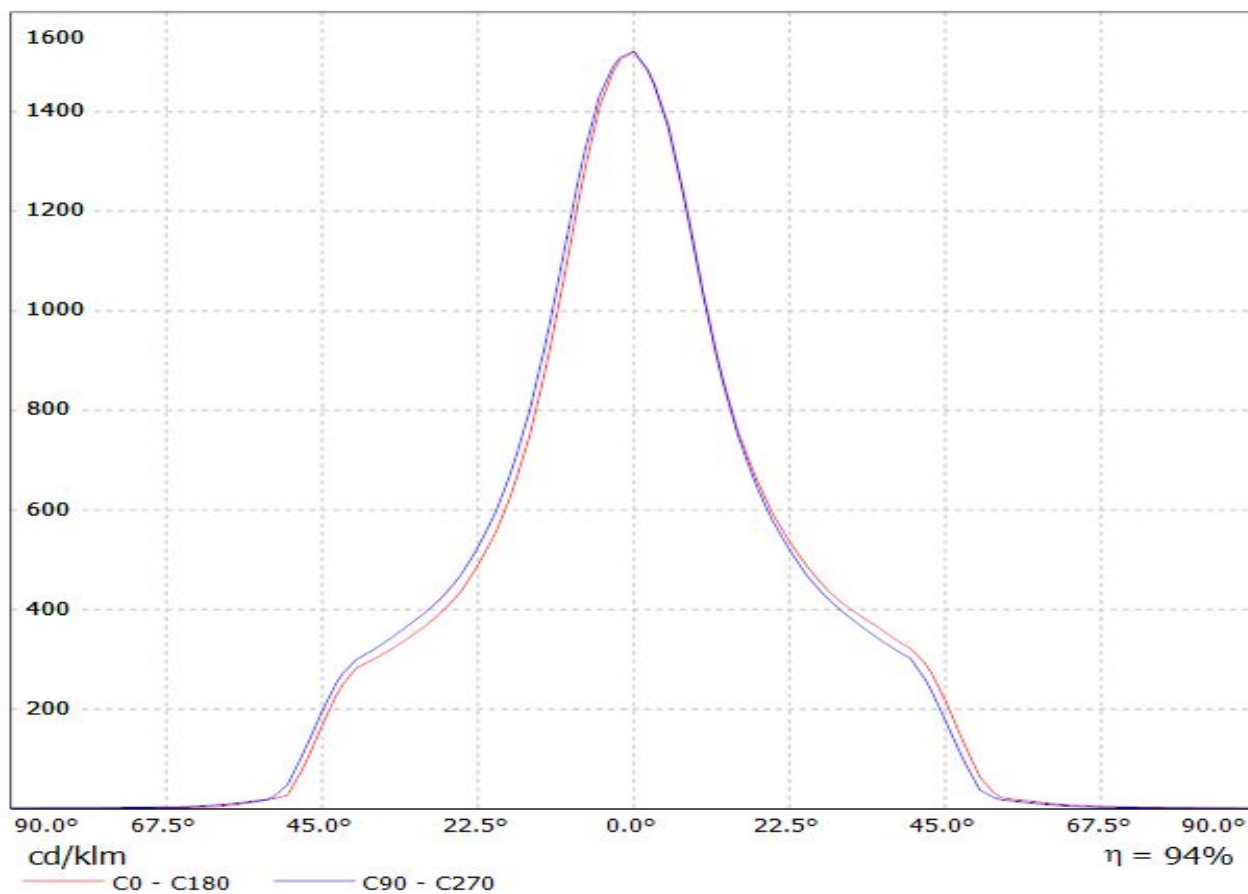

LEDiL Oy C13401_ANGELINA-M_(LUXEON_K16) Eff.93.6% / LDC (Linear)

Luminaire: LEDiL Oy C13401_ANGELINA-M_(LUXEON_K16) Eff.93.6%
Lamps: 1 x LUXEON_K16 (1204.33lm@250mA)

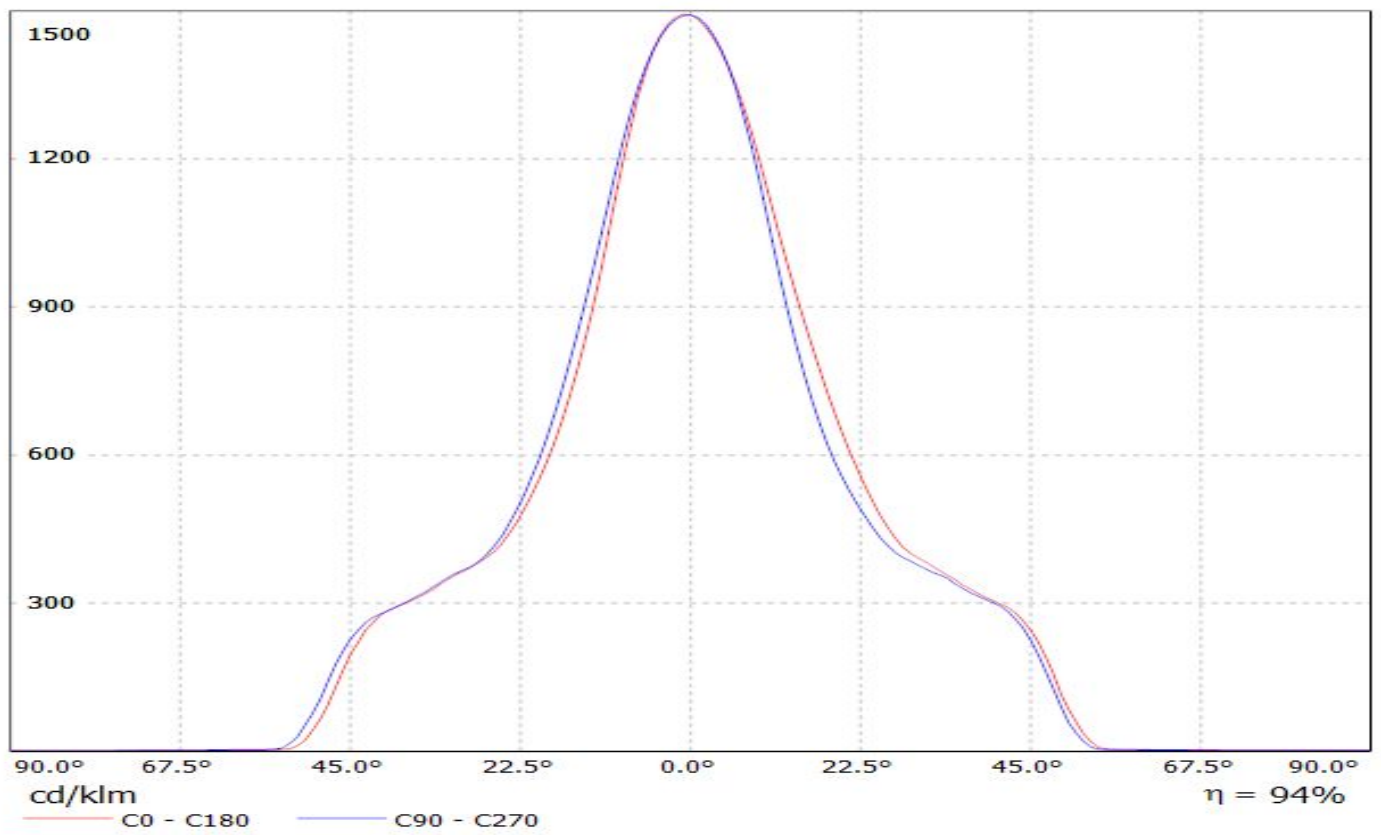

Luminaire: LEDiL Oy F13401_ANGELINA-M_(MegaZenigata) 92.0%
Lamps: 1 x MegaZenigata_GW6DME (518.495lm@100mA)

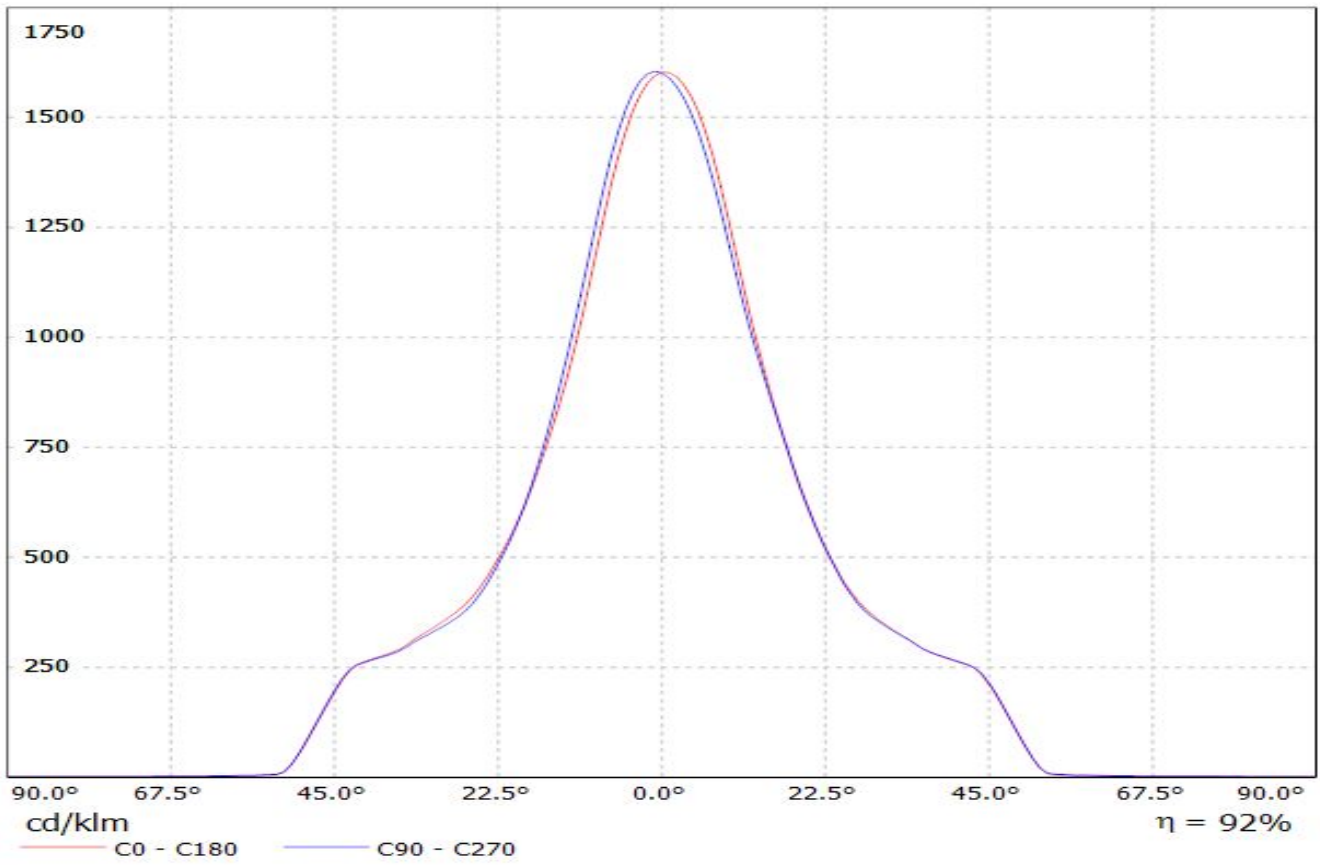

Luminaire: LEDiL Oy F13401_ANGELINA-M_(LUXEON_CoB_1208) Eff: 93 %
Lamps: 1 x Luxeon CoB 1208 (LHC1-3080-1208) 1029lm@250mA CCT=3000K P=8.2W I=250mA

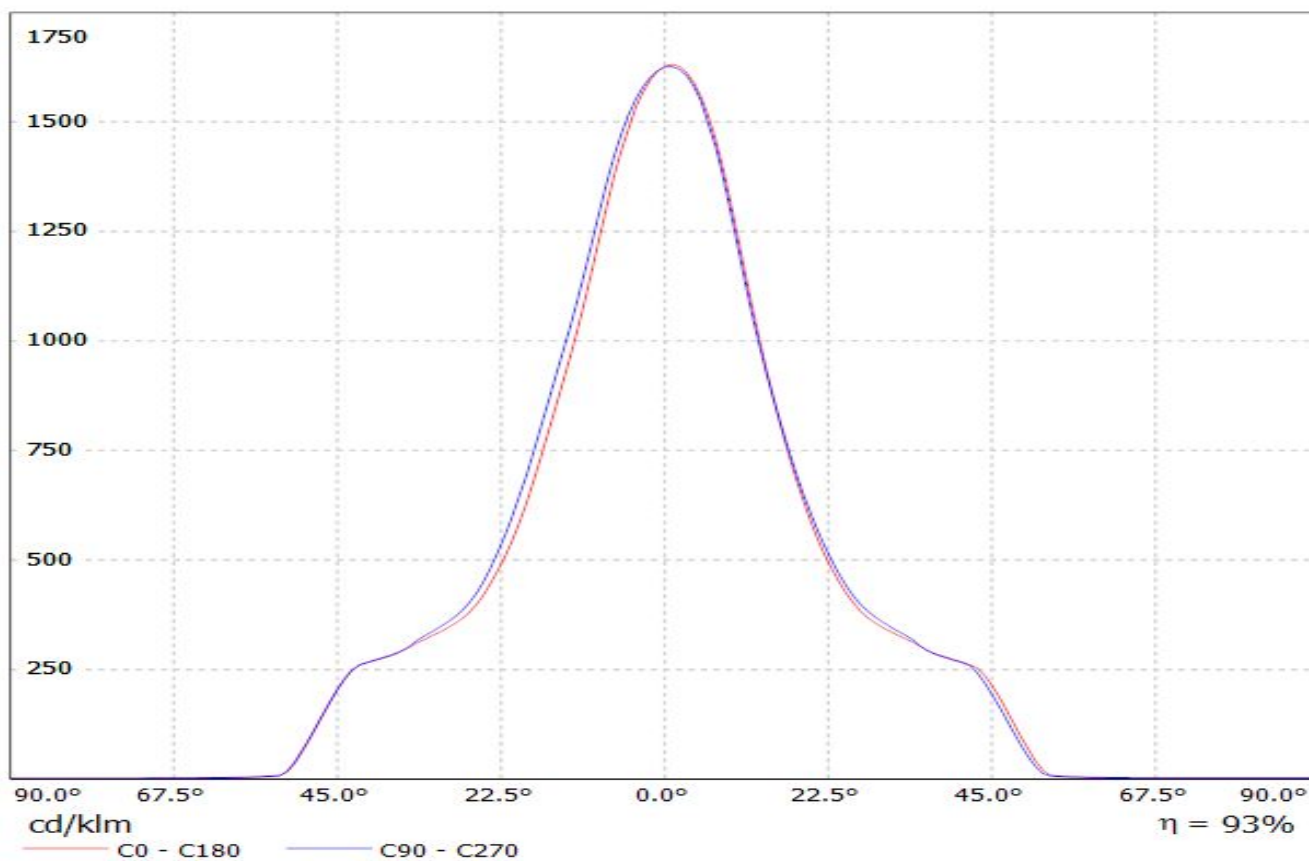

Luminaire: LEDiL Oy F13401_ANGELINA-M_(STARK_SLE_G2_LES19) Eff.91.6%
Lamps: 1 x TRIDONIC STARK SLE G2 LES19 830 CLA 964.643lm@250mA CCT=3000K P=8W I=250mA

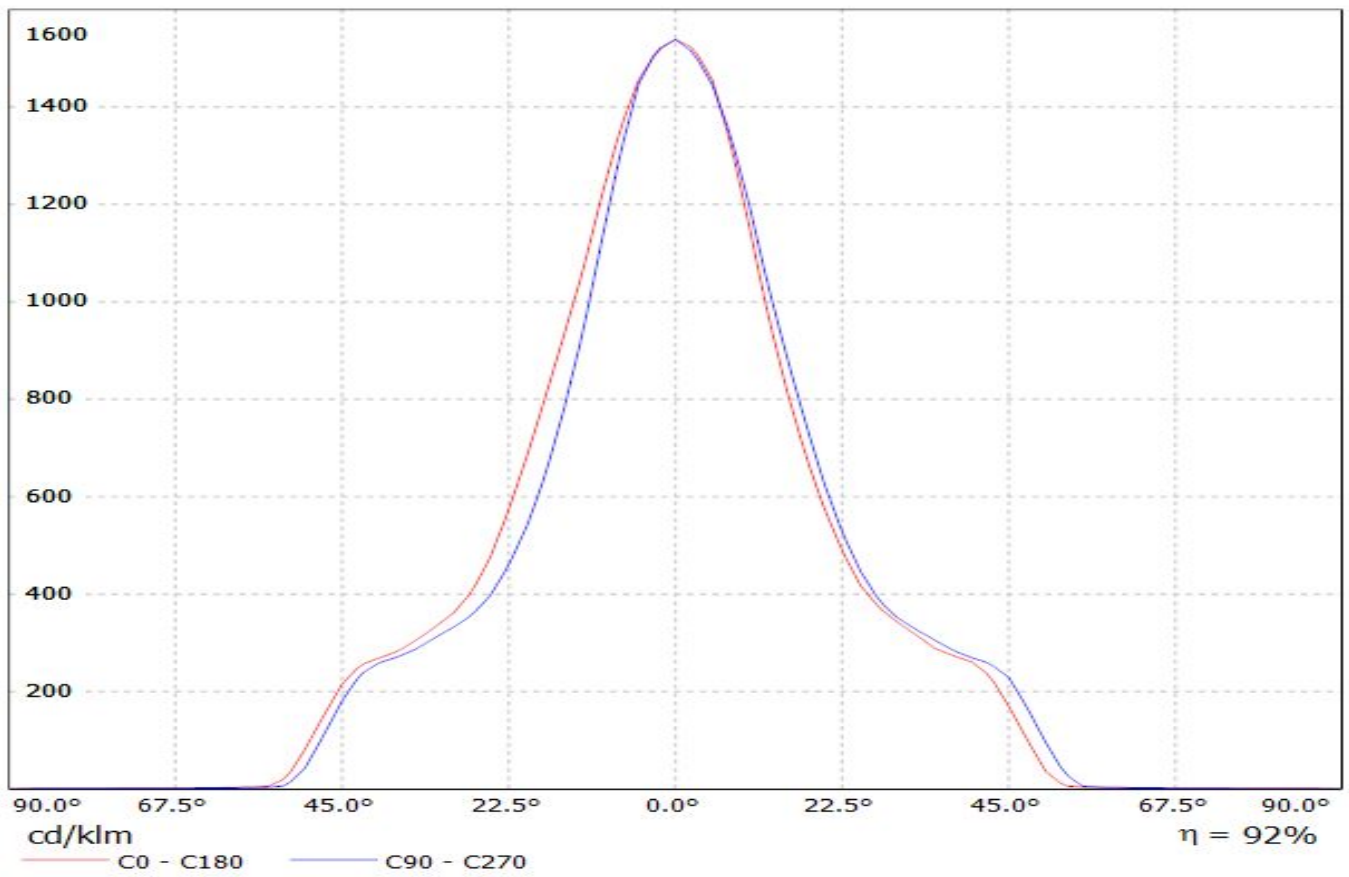

Luminaire: LEDil Oy F13401_ANGELINA-M_(Soleriq_S13) Efficiency=94%
Lamps: 1 x Osram Soleriq S13 (GW KAGHB1.EM) 855lm @ 250mA CCT=3100K P=7.5W I=250mA

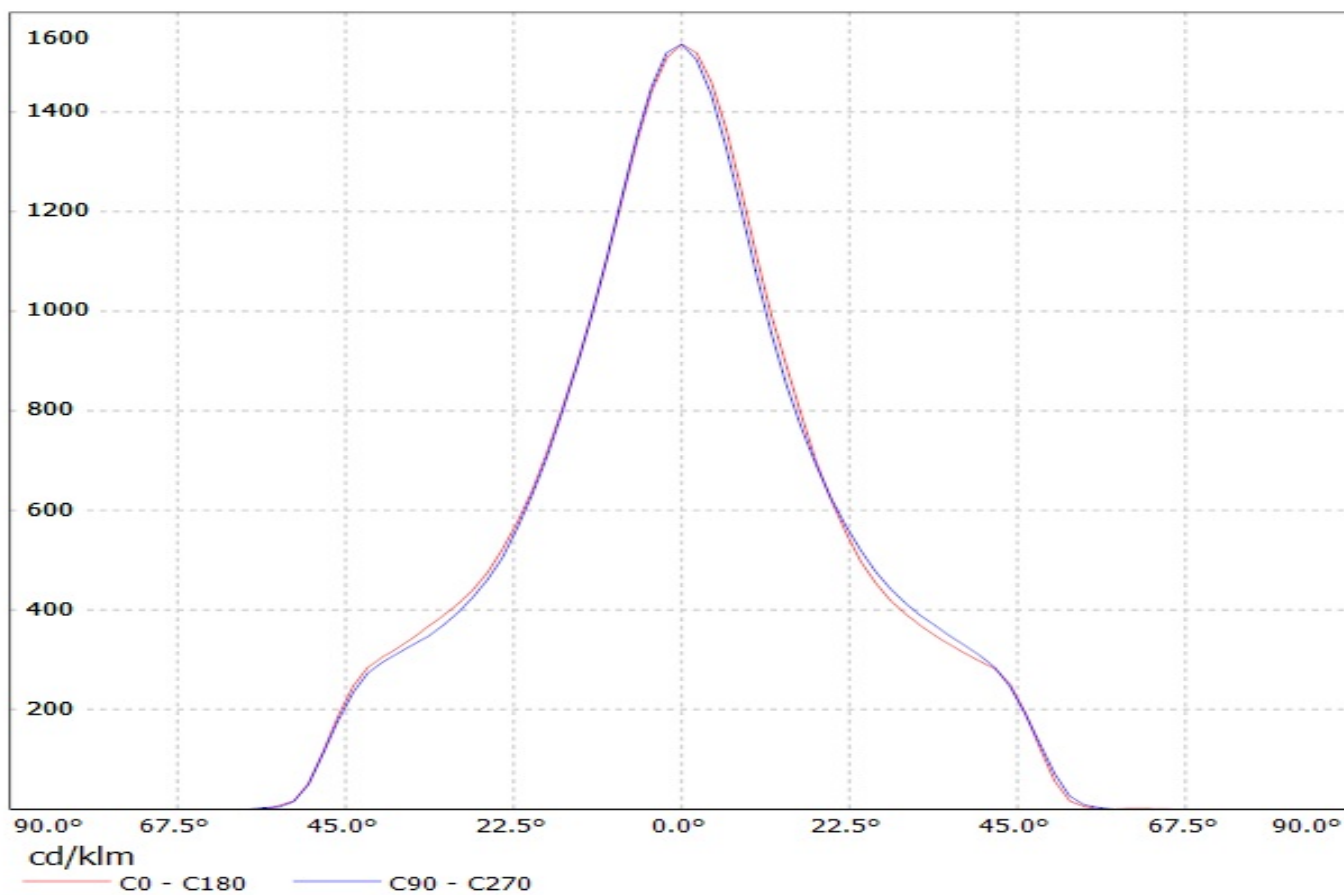

Luminaire: LEDiL Oy F13401_ANGELINA-M_(CXM-14)
Lamps: 1 x LUMINUS_CXM-14_1114.36lm@250mA_P=8.36106W_I=249.8mA

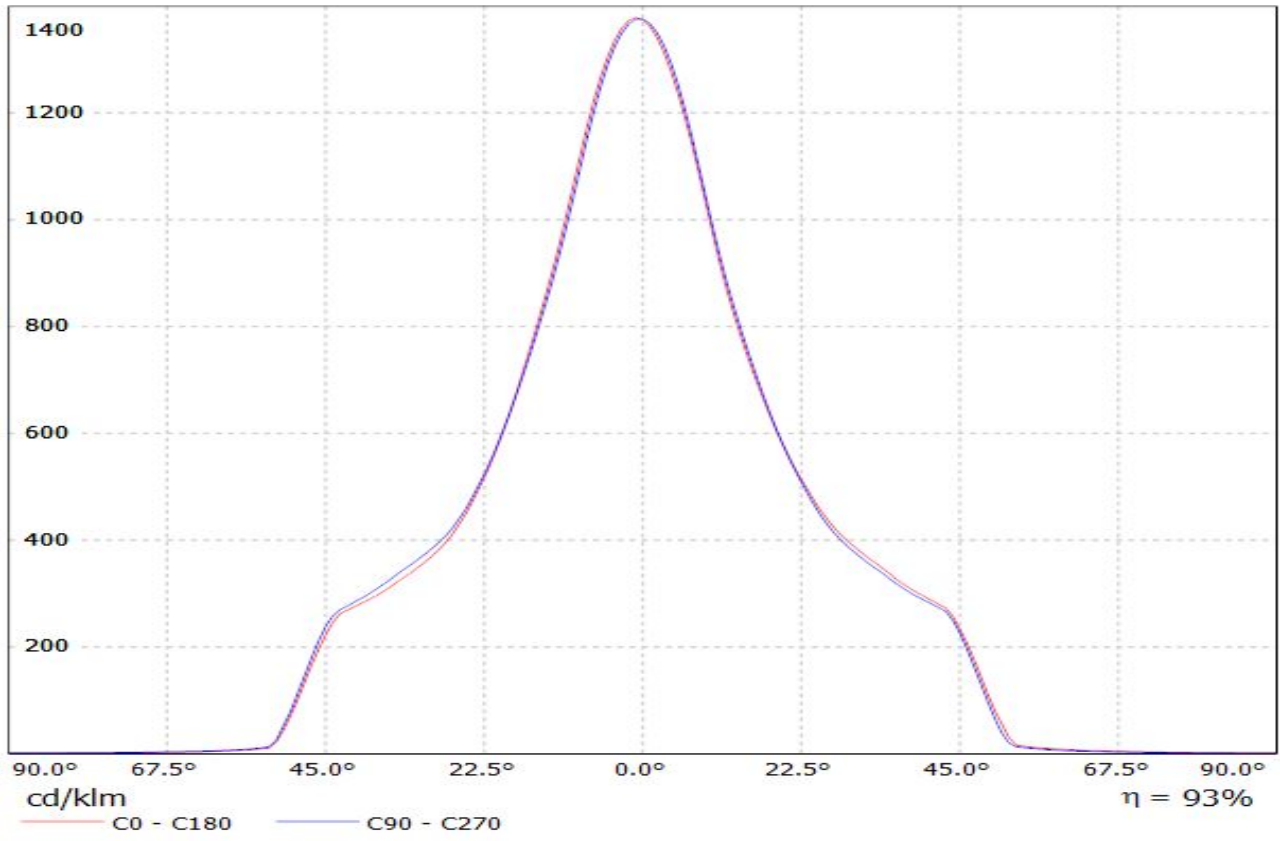

Luminaire: LEDiL Oy F13401_ANGELINA-M_(PrevaLED_Z4) Eff.93%

Lamps: 1 x Osram_PrevaLED_CORE_Z4_(PL-CORE-3000-830-Z4)_1423.93lm@250mA_P=10.7652W_I=249.9mA

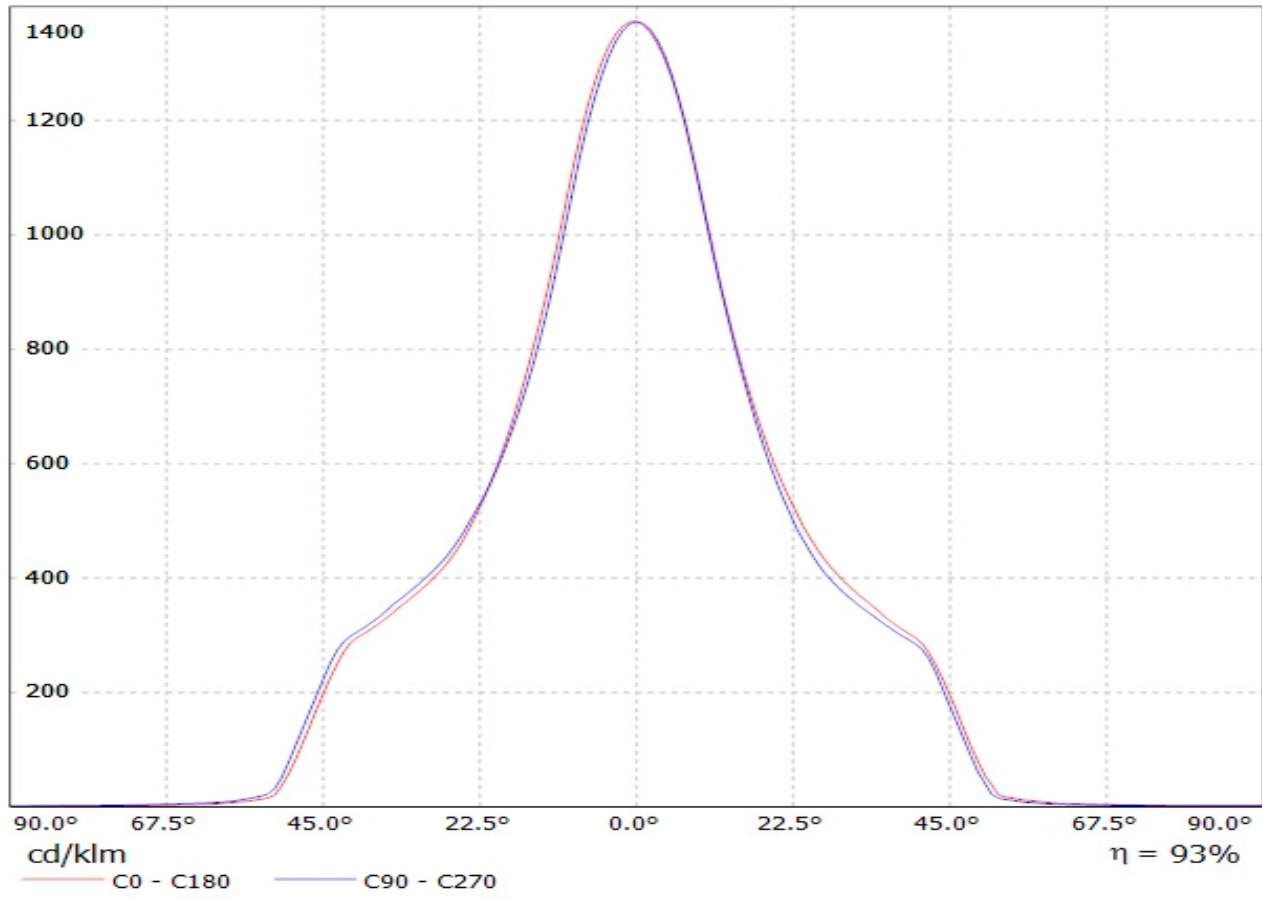

Luminaire: LEDiL Oy F13401_ANGELINA-M_(CXA25) Eff.93.0%

Lamps: 1 x CREE_CXA25_(CXA2530-7C0-T2-N0H)_1151.98lm@250mA_CCT=3000K_P=8.4892W_I=249.8mA

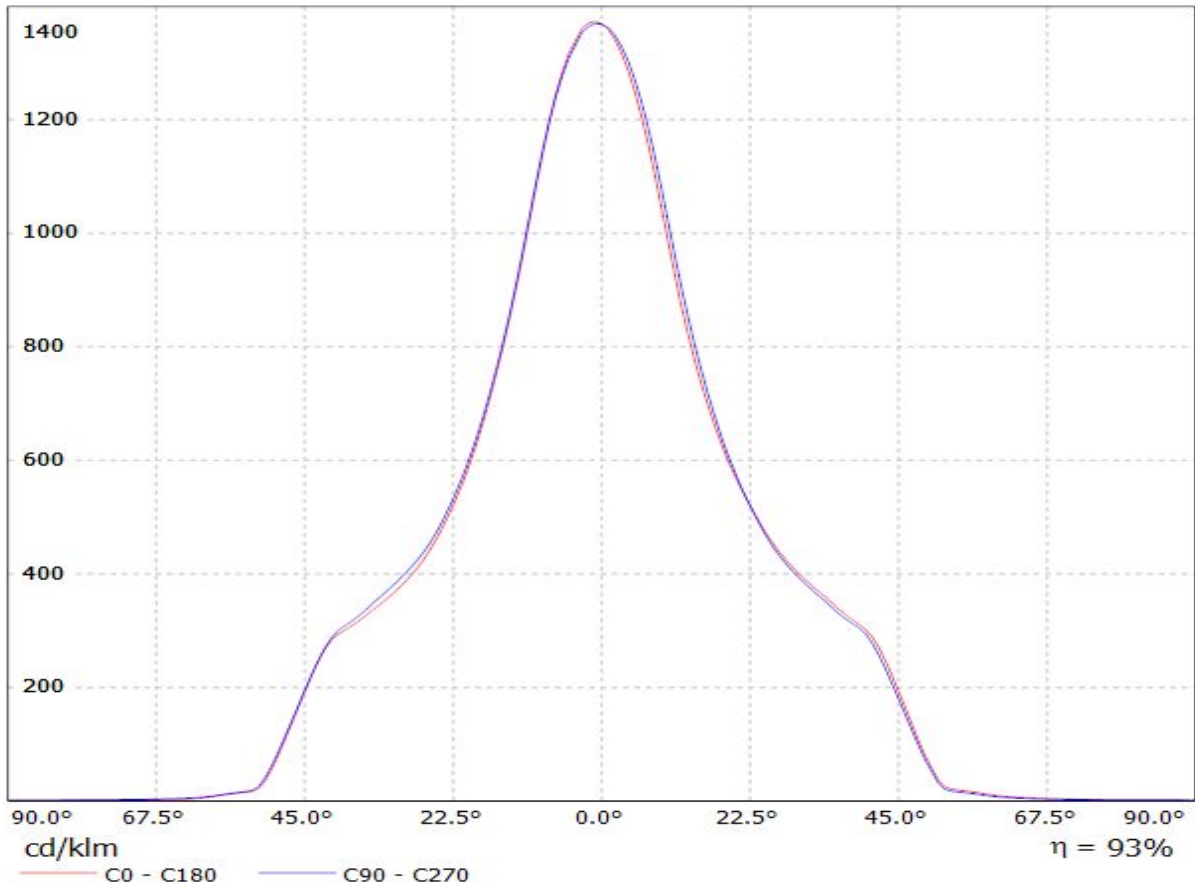

Luminaire: LEDiL Oy F13401_ANGELINA-M_(FORTIMO_2000) Eff.90.5%
Lamps: 1 x PHILIPS Fortimo LED SLM 2000 23W/930 L19 G3 665.774lm@250mA CCT=3000K P=6W I=250mA

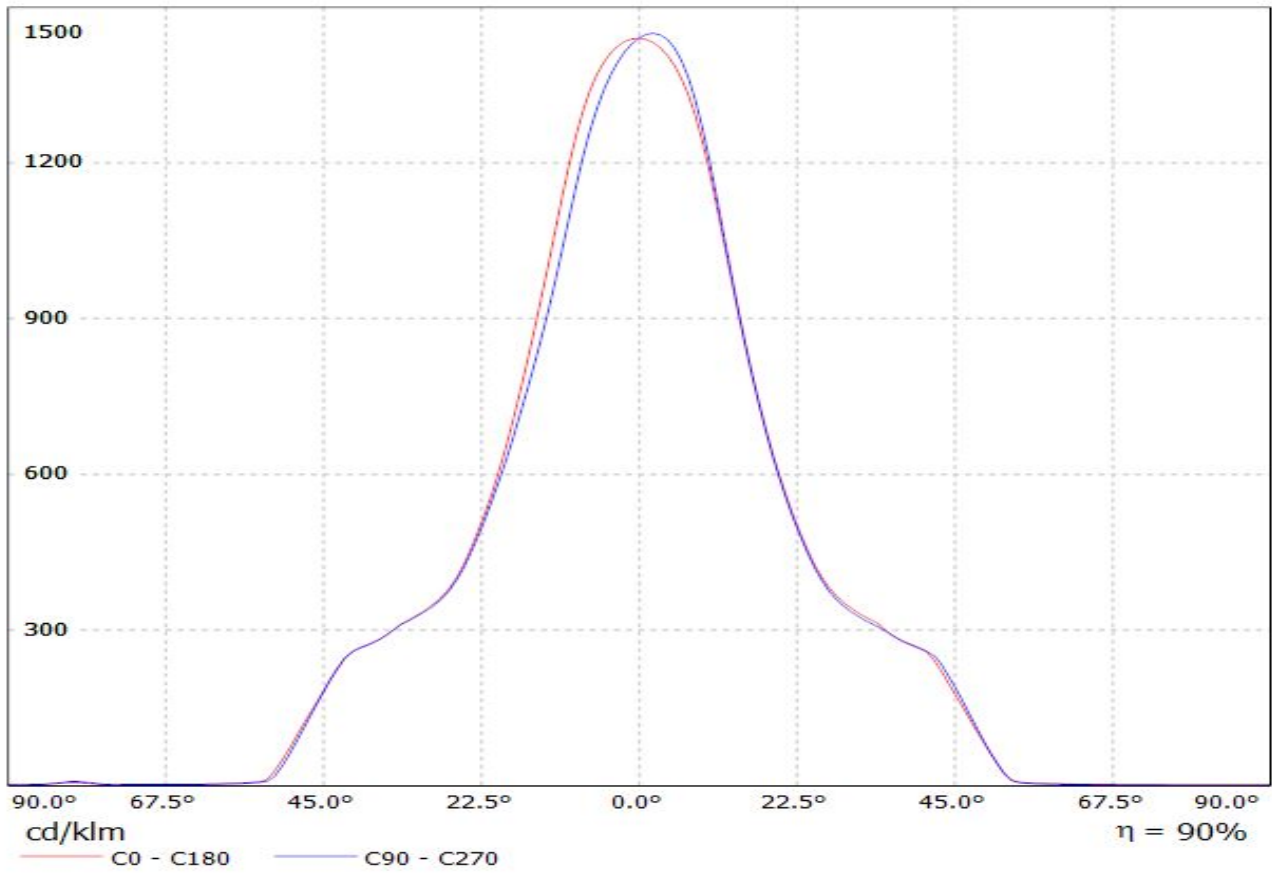

Luminaire: LEDiL Oy F13401_ANGELINA-M_(FORTIMO_3000) Eff.90.3%
Lamps: 1 x PHILIPS Fortimo LED SLM 3000 28W/830 L19 G3 1046.76lm@250mA CCT=3000K P=9W I=250mA

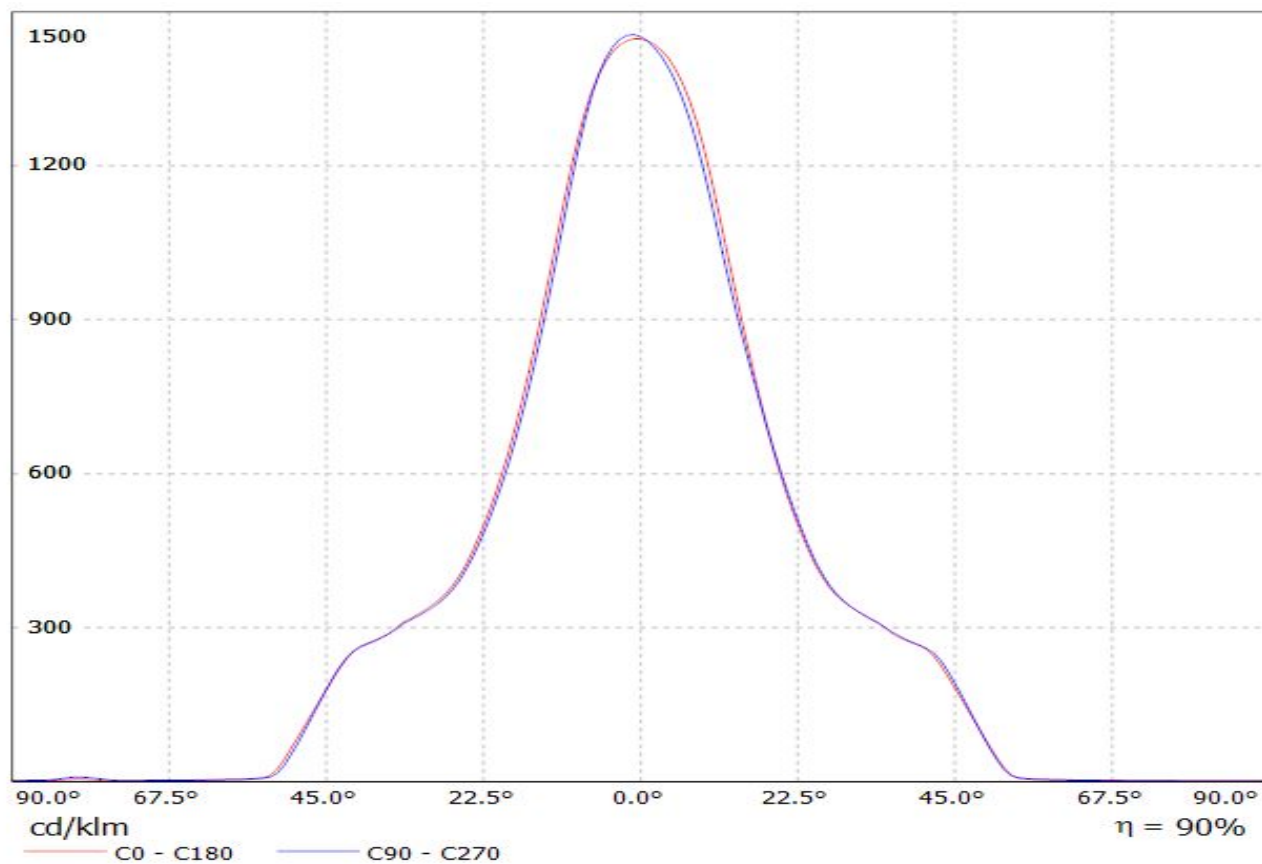

Luminaire: LEDiL F13401_ANGELINA-M_(CLL030)

Lamps: 1 x CLL030 740lm@250mA (CLL030-1205A5-303H1A7) CCT:3000K P:8.6W

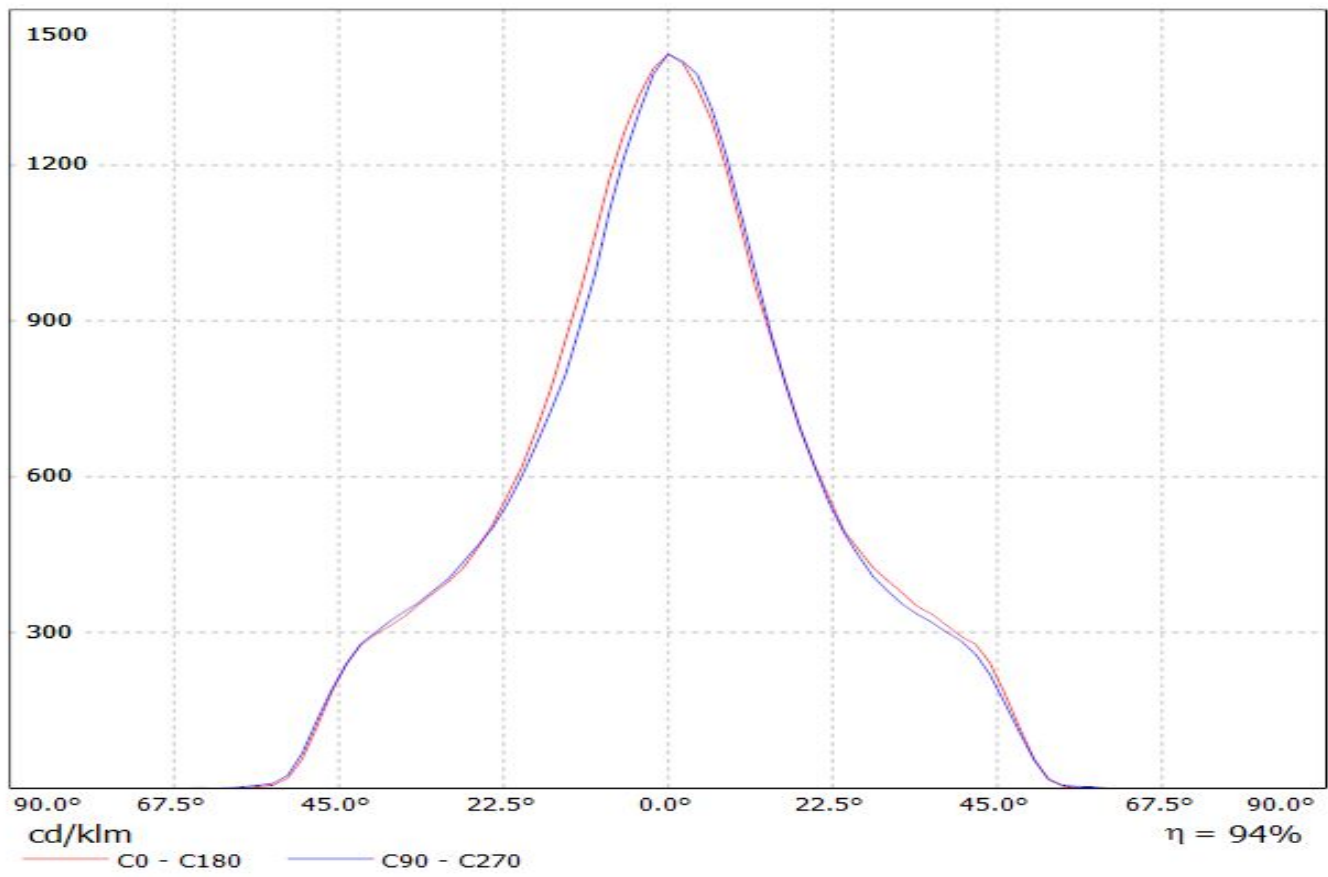

Luminaire: LEDiL Oy F13401_ANGELINA-M_(WU-M-461-827)
Lamps: 1 x Vossloh_WU-M-461-827_773.276lm@250mA_P=6.27423W_I=249.8mA

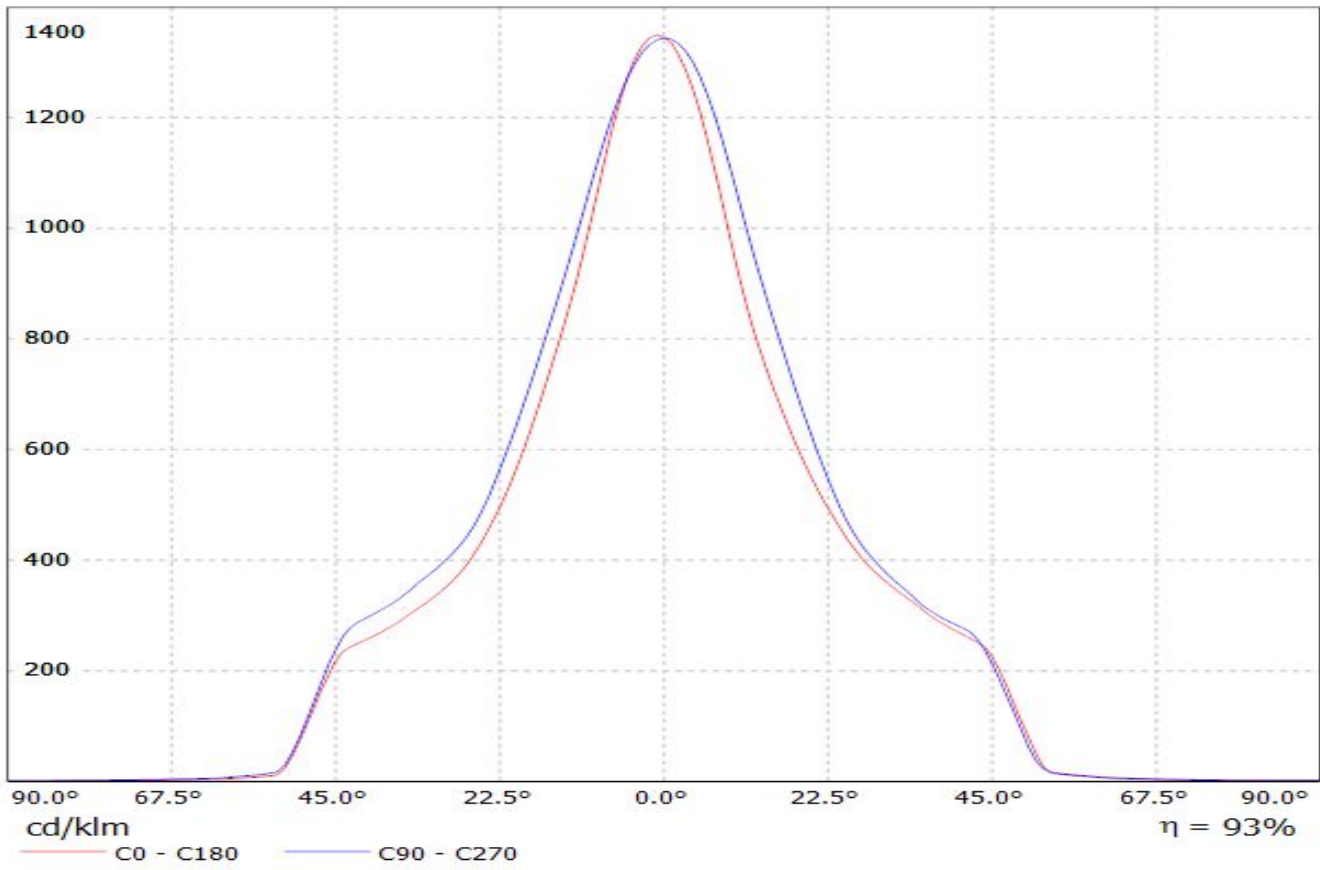

Luminaire: LEDiL Oy F13401_ANGELINA-M_(WU-M-484)

Lamps: 1 x Vossloh_Schwabe-WU-M-484_(WU-M-484-830)_657.125lm@250mA_P=5.59976W_I=249.9mA

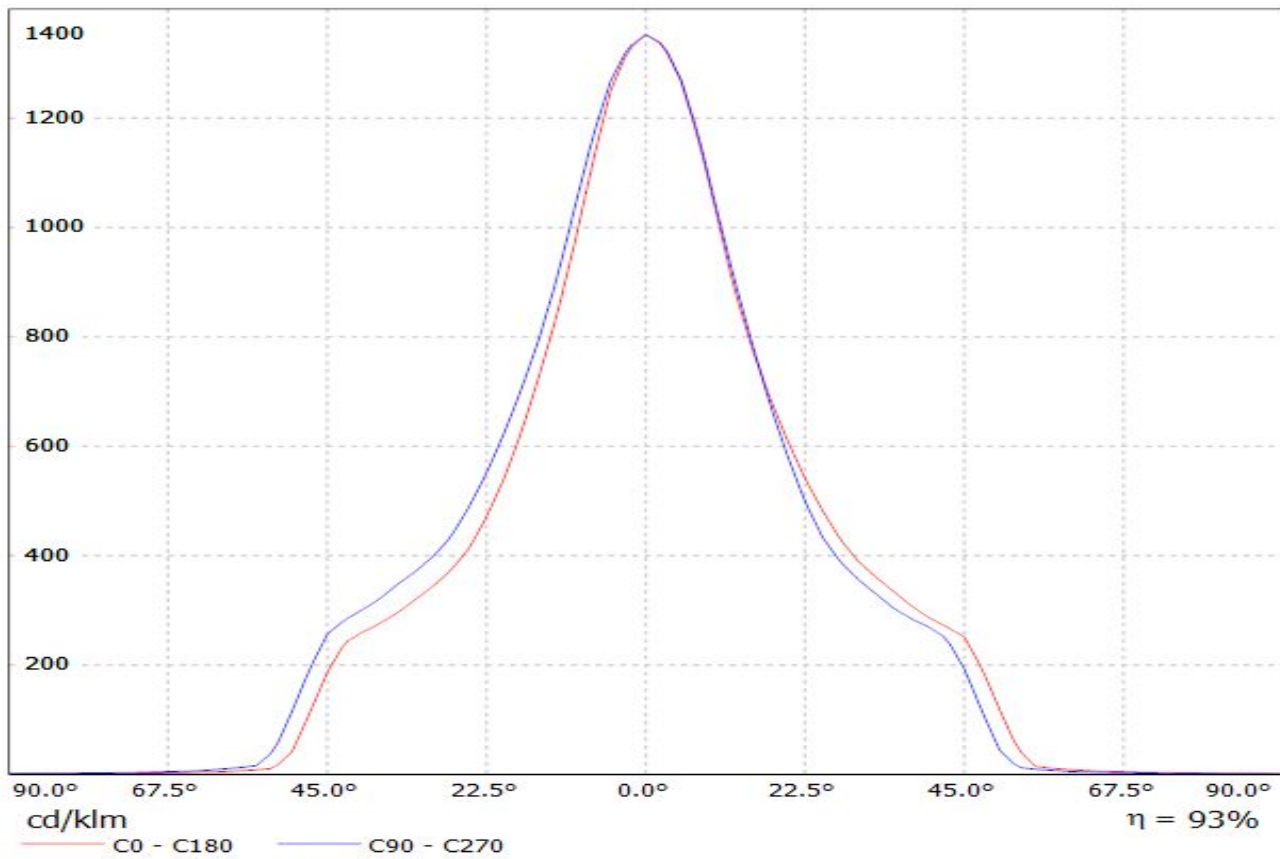

Luminaire: LEDiL Oy F13401_ANGELINA-M_(LEP-2000-827-C-AC)
Lamps: 1 x OSRAM PrevaLED Core AC (LEP-2000-827-C-AC)

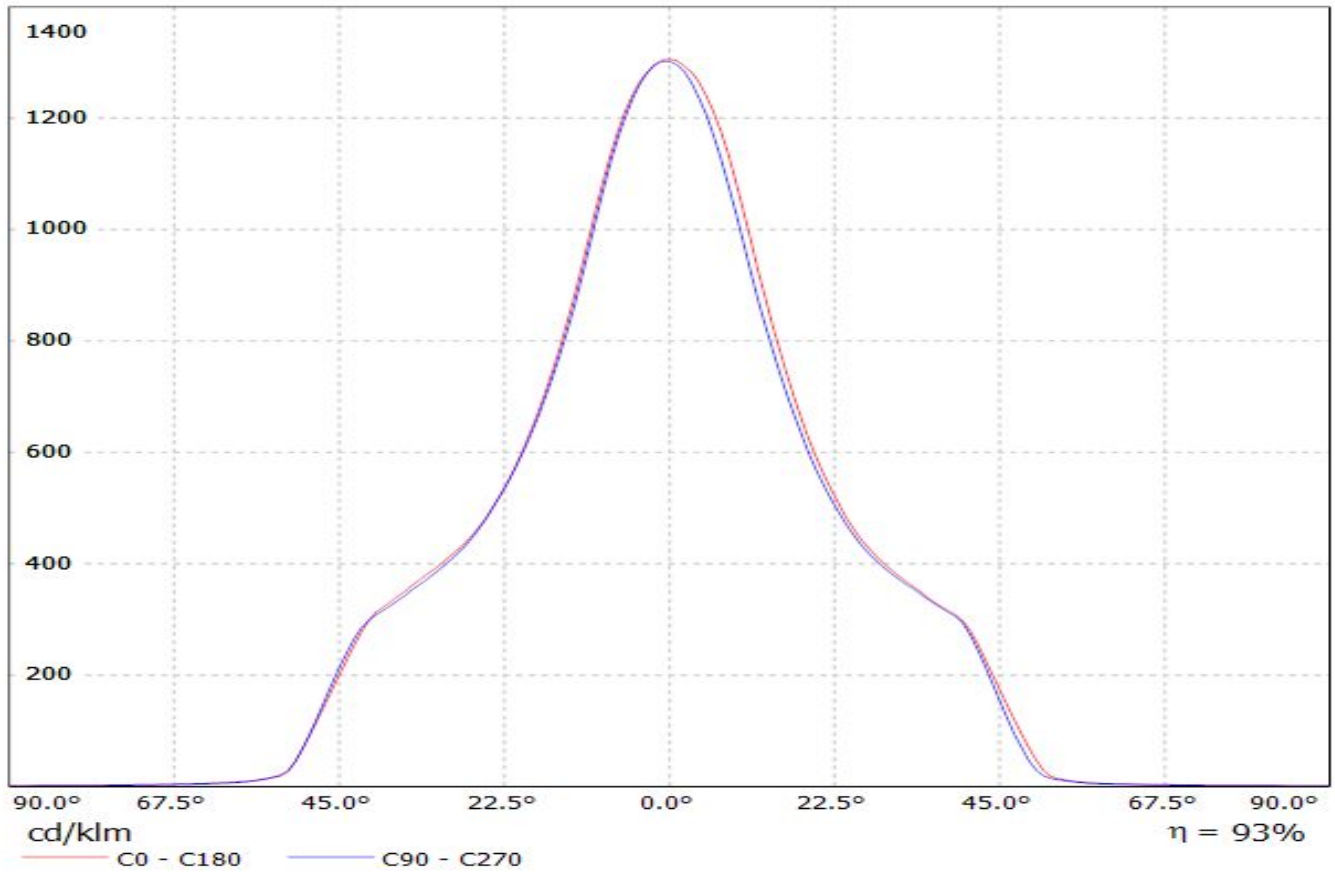

Luminaire: LEDiL Oy F13401_ANGELINA-M_(PrevaLED_LES19) Eff. 93%
Lamps: 1 x PrevaLED_LES219_(PL-CORE-2000-830-Z3)_1333.47lm@250mA_P=10.4584W_I=249.8mA

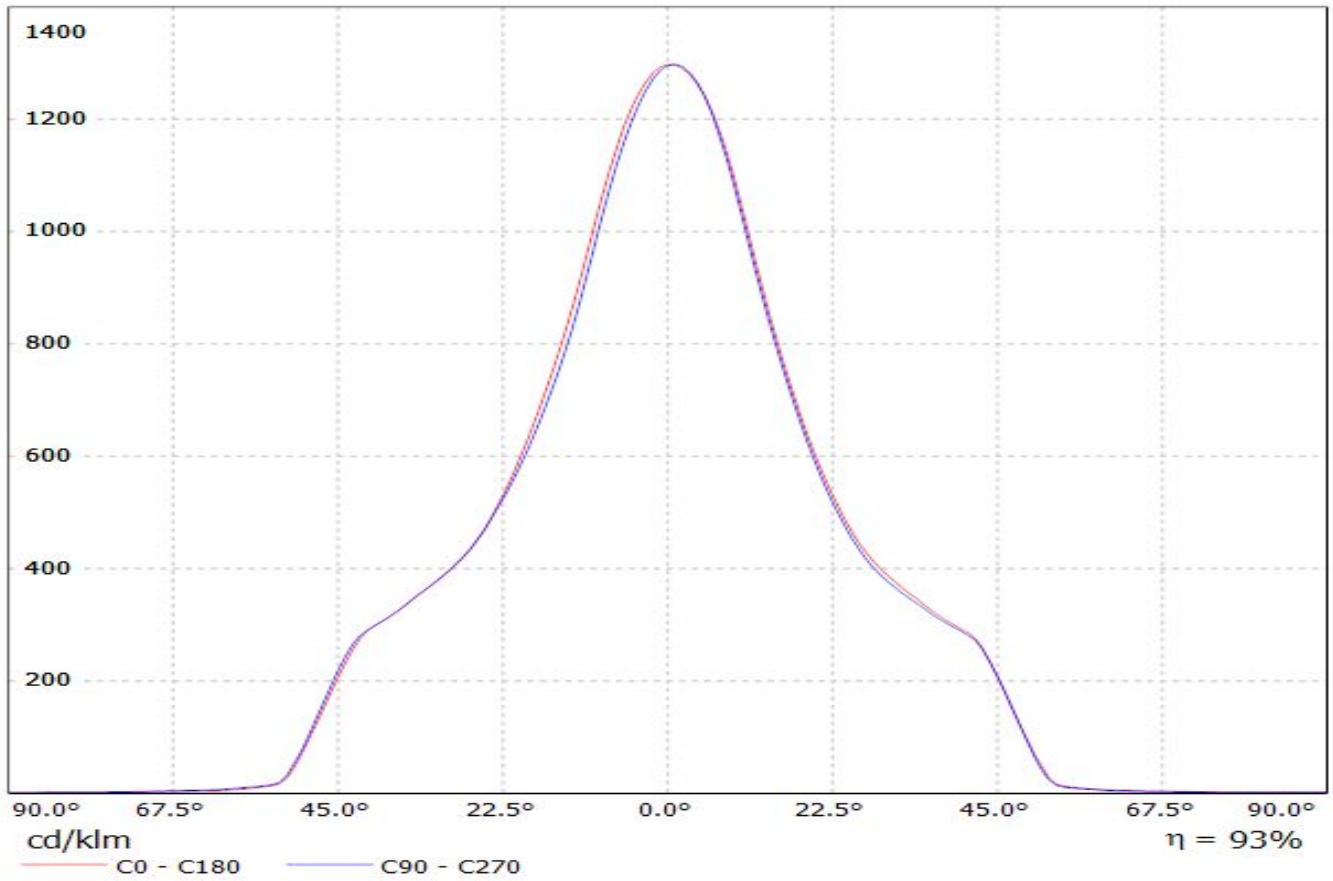

Luminaire: LEDiL Oy F13401_ANGELINA-M_(SOLERIQ_S19_&_TE_2213407-2)

Lamps: 1 x OSRAM_SOLERIQ_S19_(GW_KAHJB1.EM)_1393.62lm@250mA_CCT=3000K_P=10.5683W_I=249.8mA

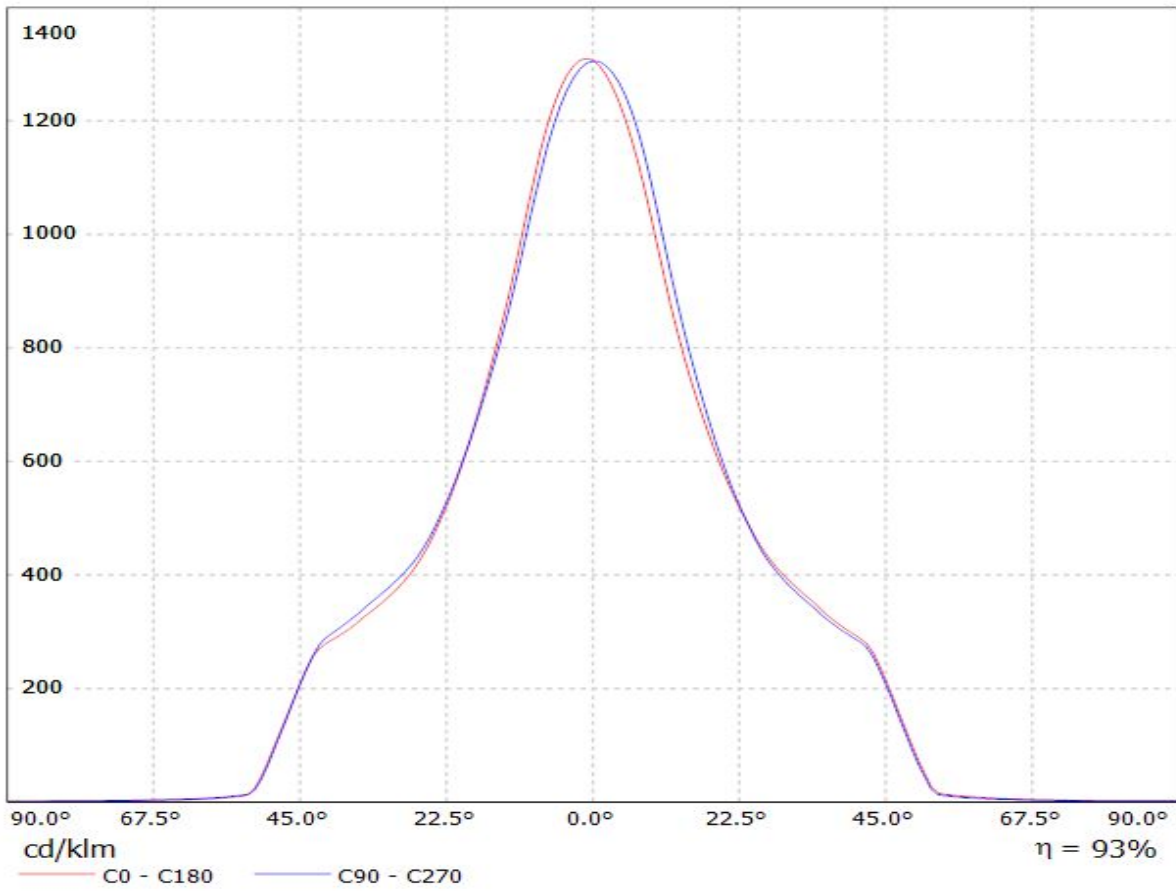

Luminaire: LEDiL Oy F13401_ANGELINA-M_(NSBxL121A)
Lamps: 1 x Nichia_NSBxL121A_914.478lm@250mA_P=7.56872W_I=249.9mA

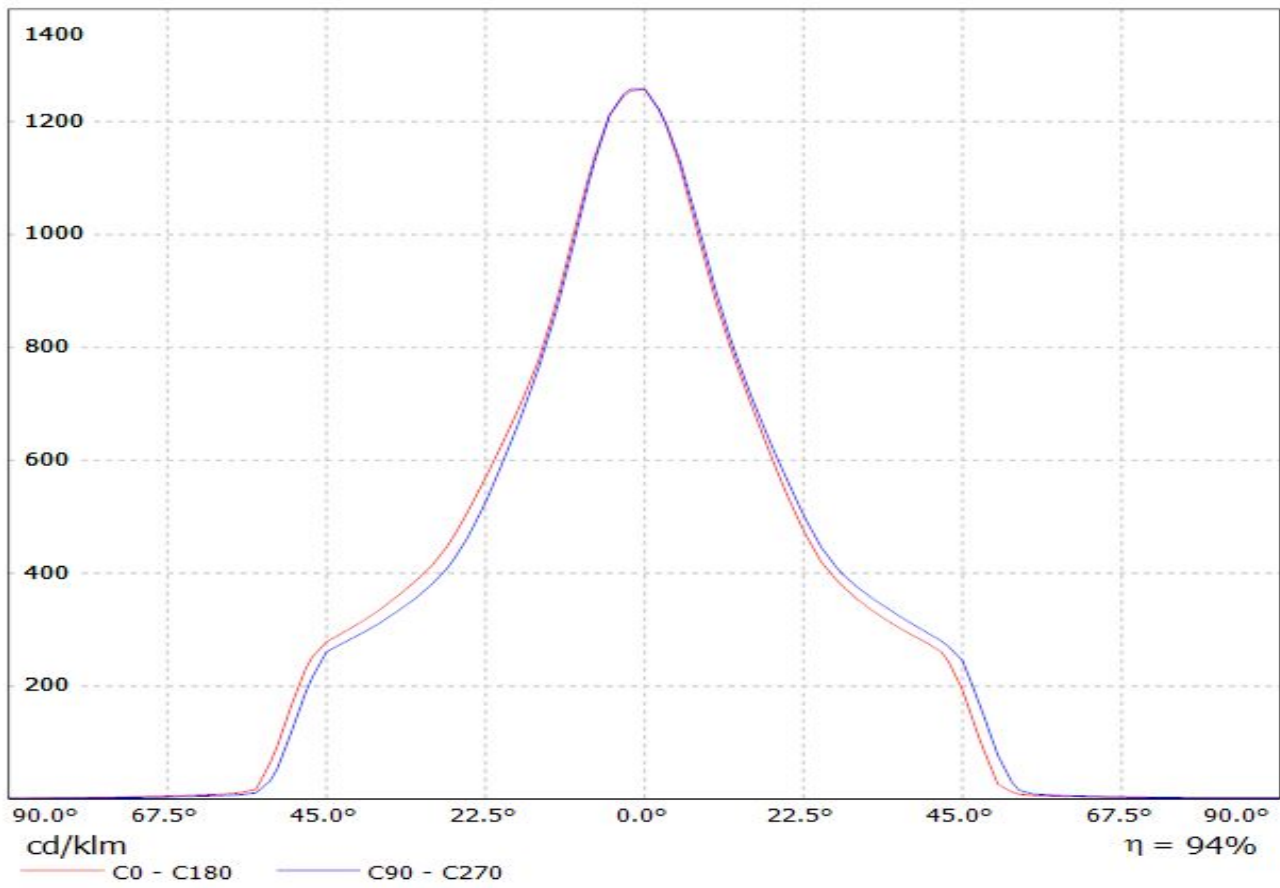

Luminaire: LEDiL Oy F13401_ANGELINA-M (STARK_SLE_G2_LES23) Eff.90.2%
Lamps: 1 x TRIDONIC STARK SLE G2 LES23 830 CLA 982.731lm@250mA CCT=3000K P=8W I=250mA

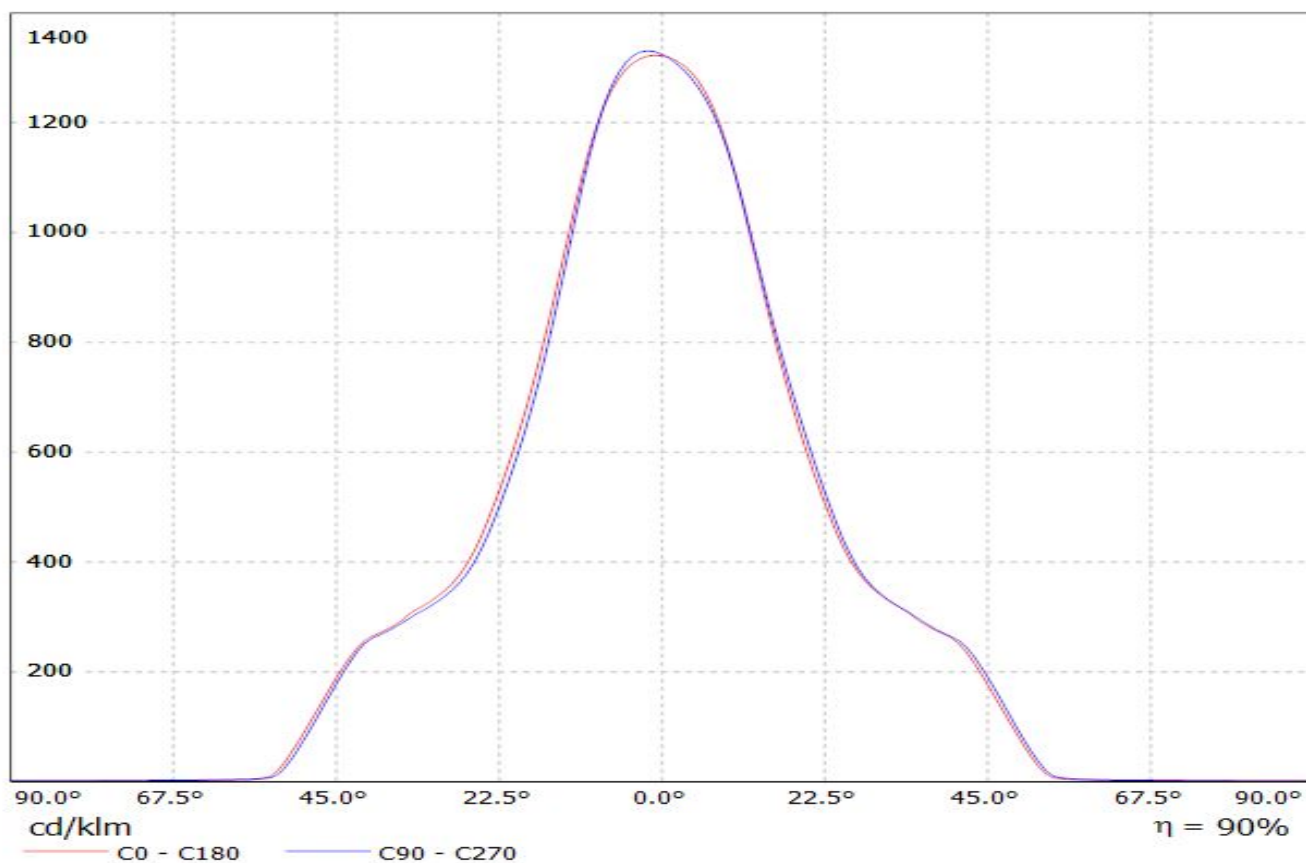

Luminaire: LEDiL Oy F13401_ANGELINA-M_(SLE_G3_LES19) Eff.92.1%

Lamps: 1 x TRIDONIC_STARK_SLE_G3_LES19_(STARK-SLE-G3-LES19-2000-840-CLA)_1058.33lm@250mA_P=8.32833W_I=249.8mA

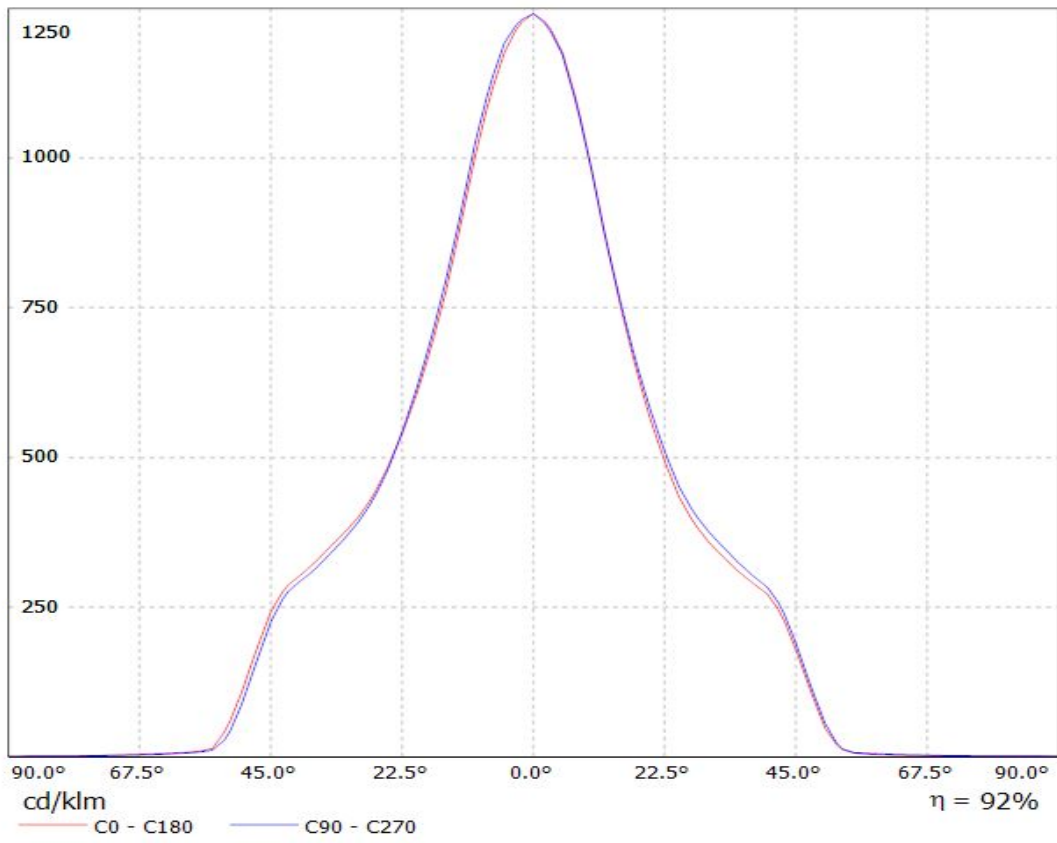

Luminaire: LEDiL Oy F13401_ANGELINA-M_(FORTIMO_3000) Eff.90.3%
Lamps: 1 x PHILIPS Fortimo LED SLM 3000 28W/830 L19 G3 1046.76lm@250mA CCT=3000K P=9W I=250mA

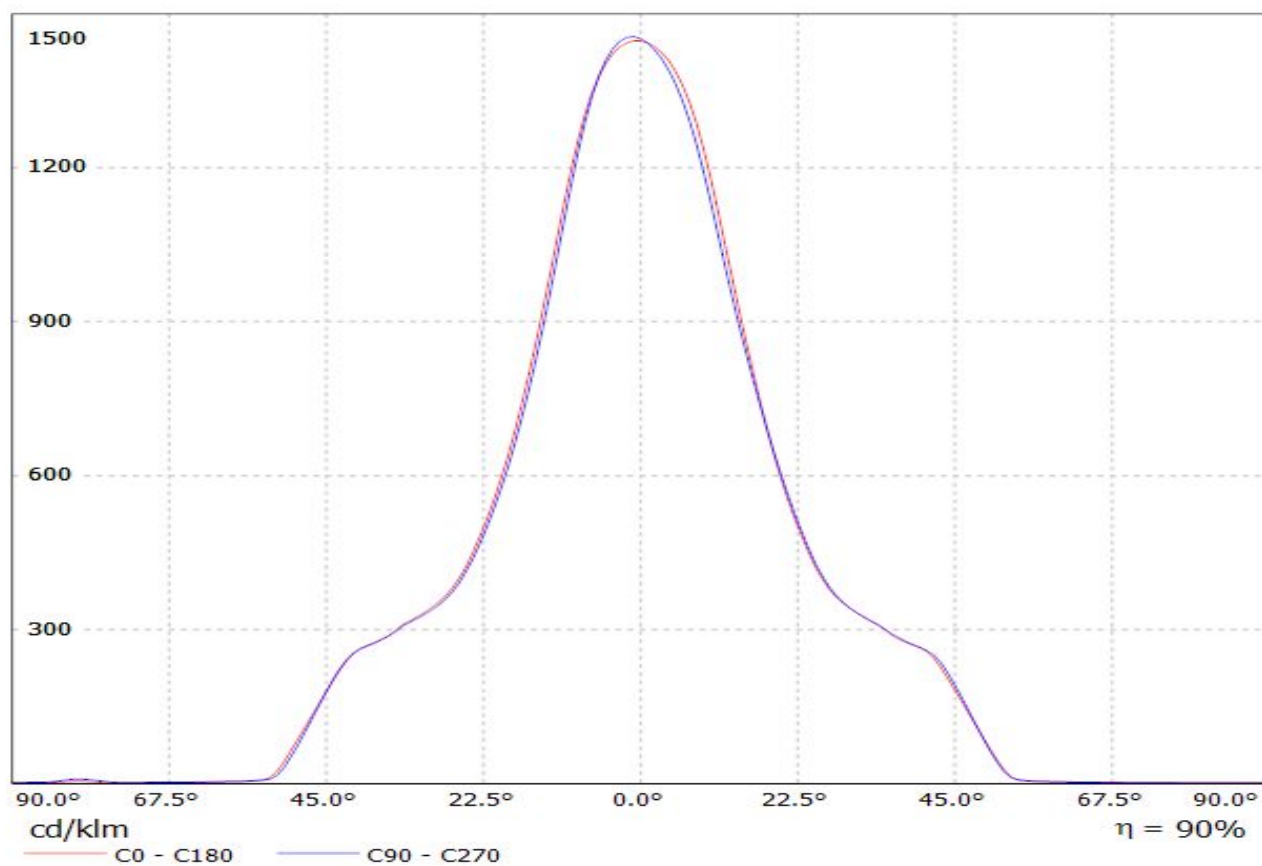

Luminaire: LEDiL Oy F13325_ANGELINA-S_(COB-LC026B) Eff.93.5%

Lamps: 1 x SAMSUNG_COB-LC026B_(SPHWWTHDNC25YHV52F)_1136.23lm@250mA_P=8.23191W_I=249.8mA

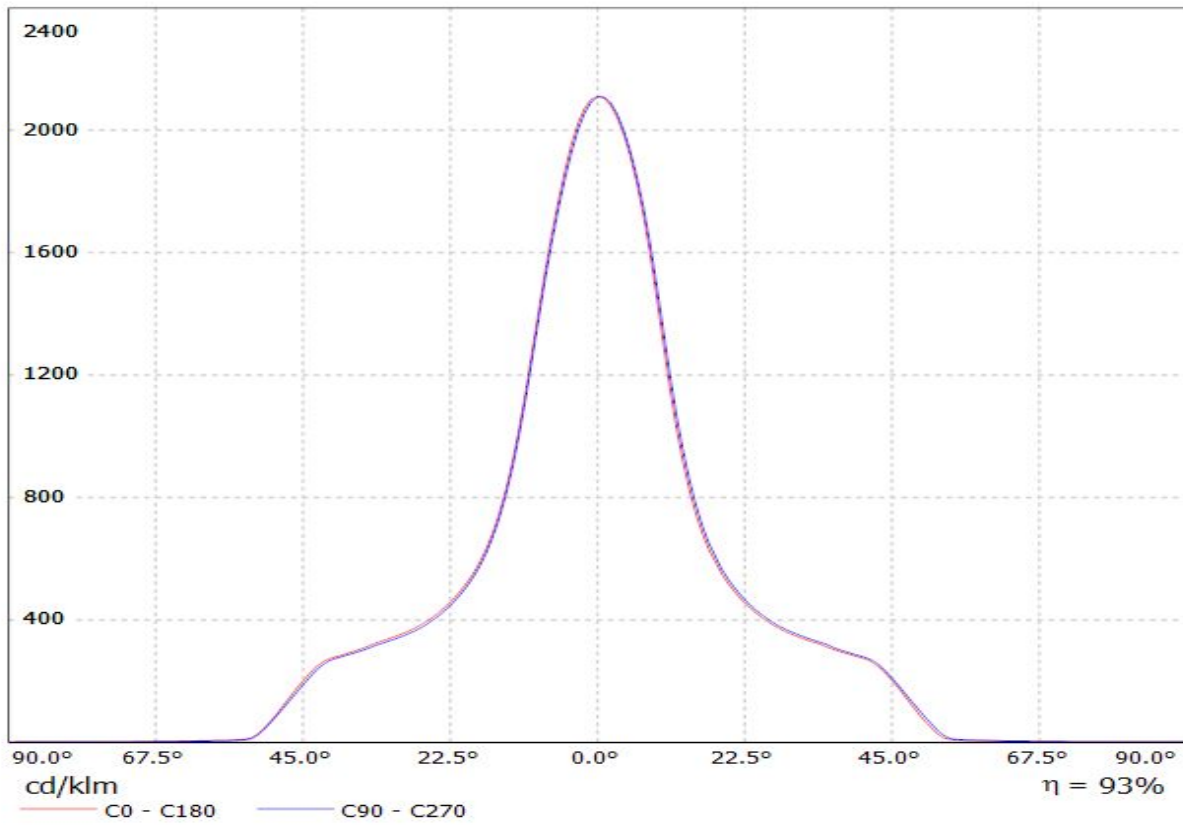

Luminaire: LEDiL Oy F13401_ANGELINA-M_(CXA30) Eff. 93%
Lamps: 1 x CREE_CXA30_(CXA3050-3C0-Y2-N0H)_1340.66lm@250mA_P=8.16471W_CCT=5000K_I=249.8mA

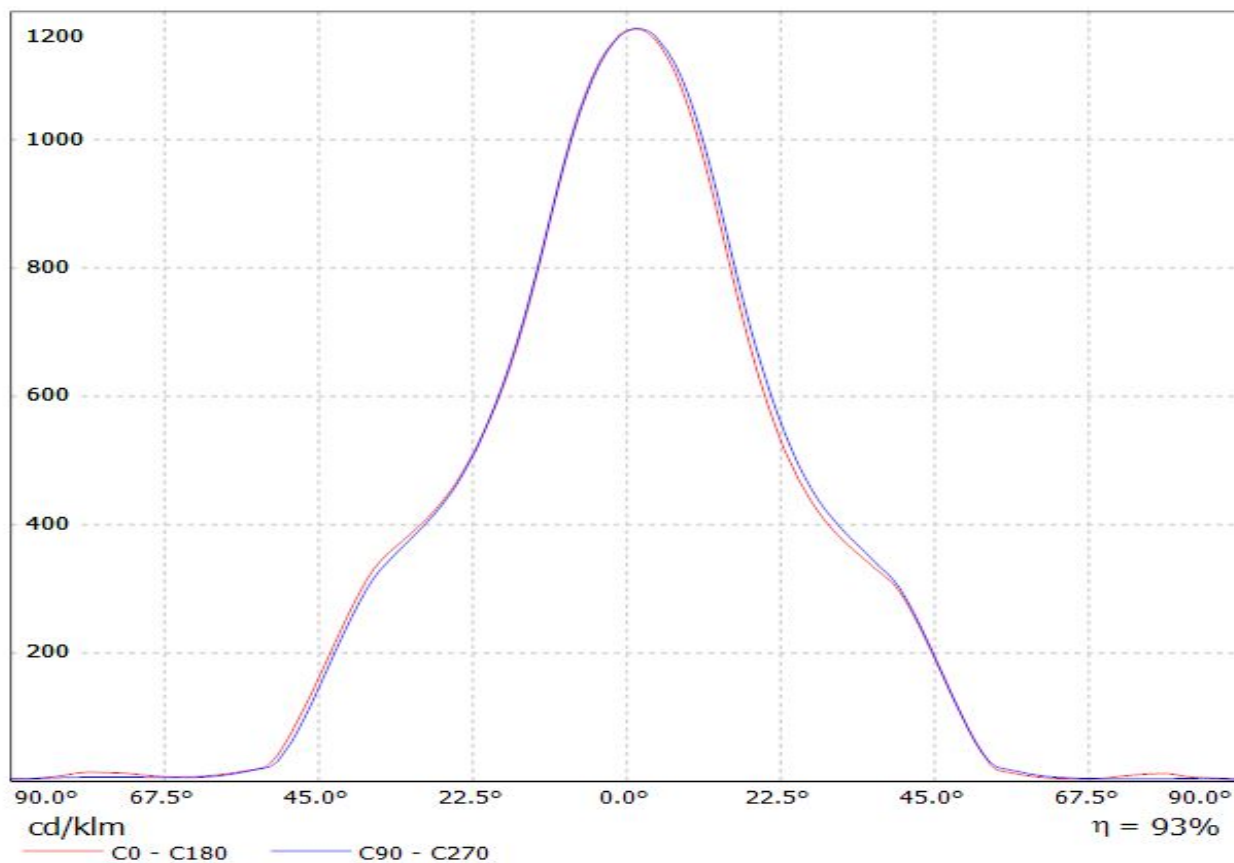

Luminaire: LEDiL Oy F13401_ANGELINA-M_(STARK_SLE_G2_LES26) Eff.89.0%
Lamps: 1 x TRIDONIC STARK SLE G2 LES26 830 CLA 1095.88lm@250mA CCT=3000K P=8W I=250mA

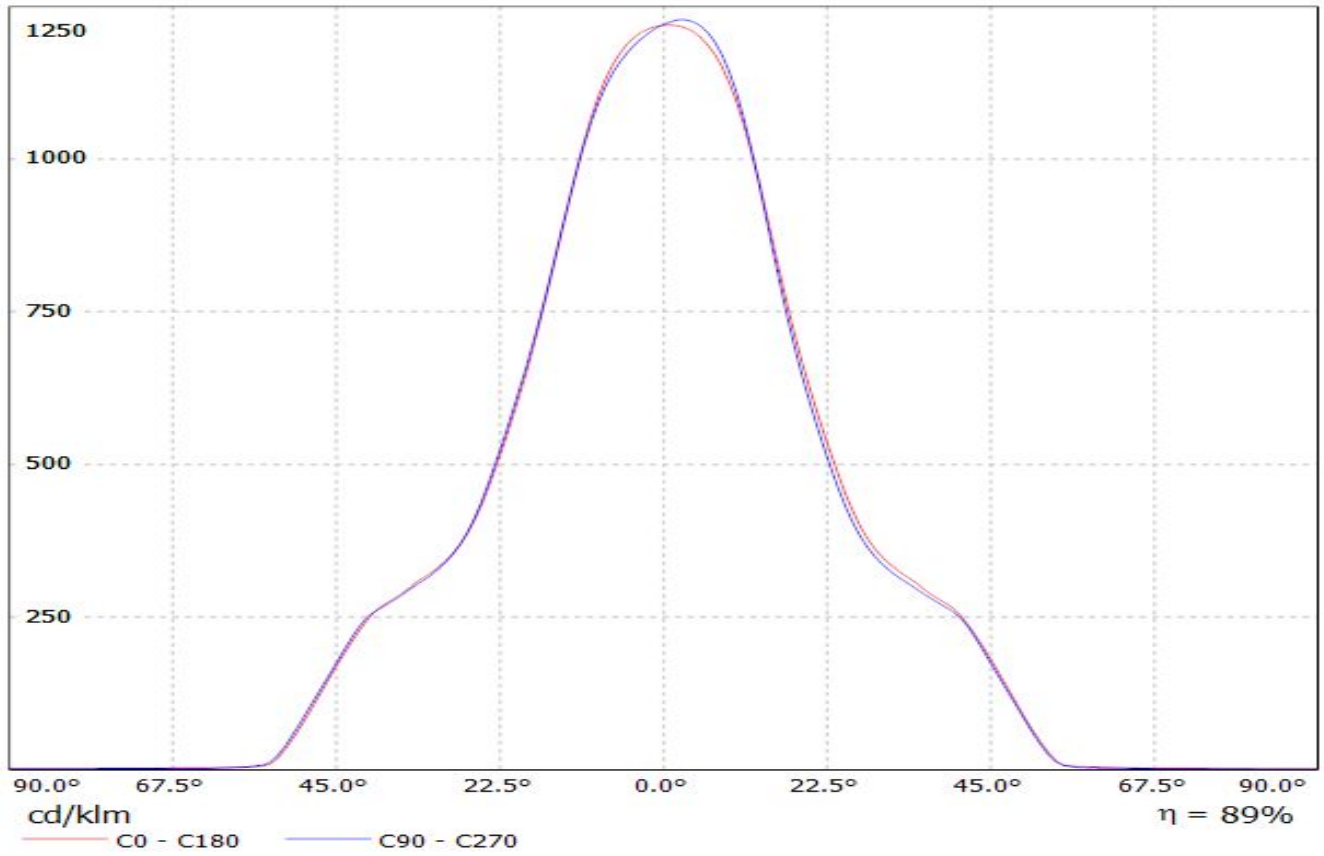

Luminaire: LEDiL Oy F13401_ANGELINA-M_(WU-M-486) Eff.92.1%
Lamps: 1 x Vossloh_Schwabe-WU-M-486_(WU-M-486-830)
_1474.55lm@250mA_P=10.4456W_I=249.8mA

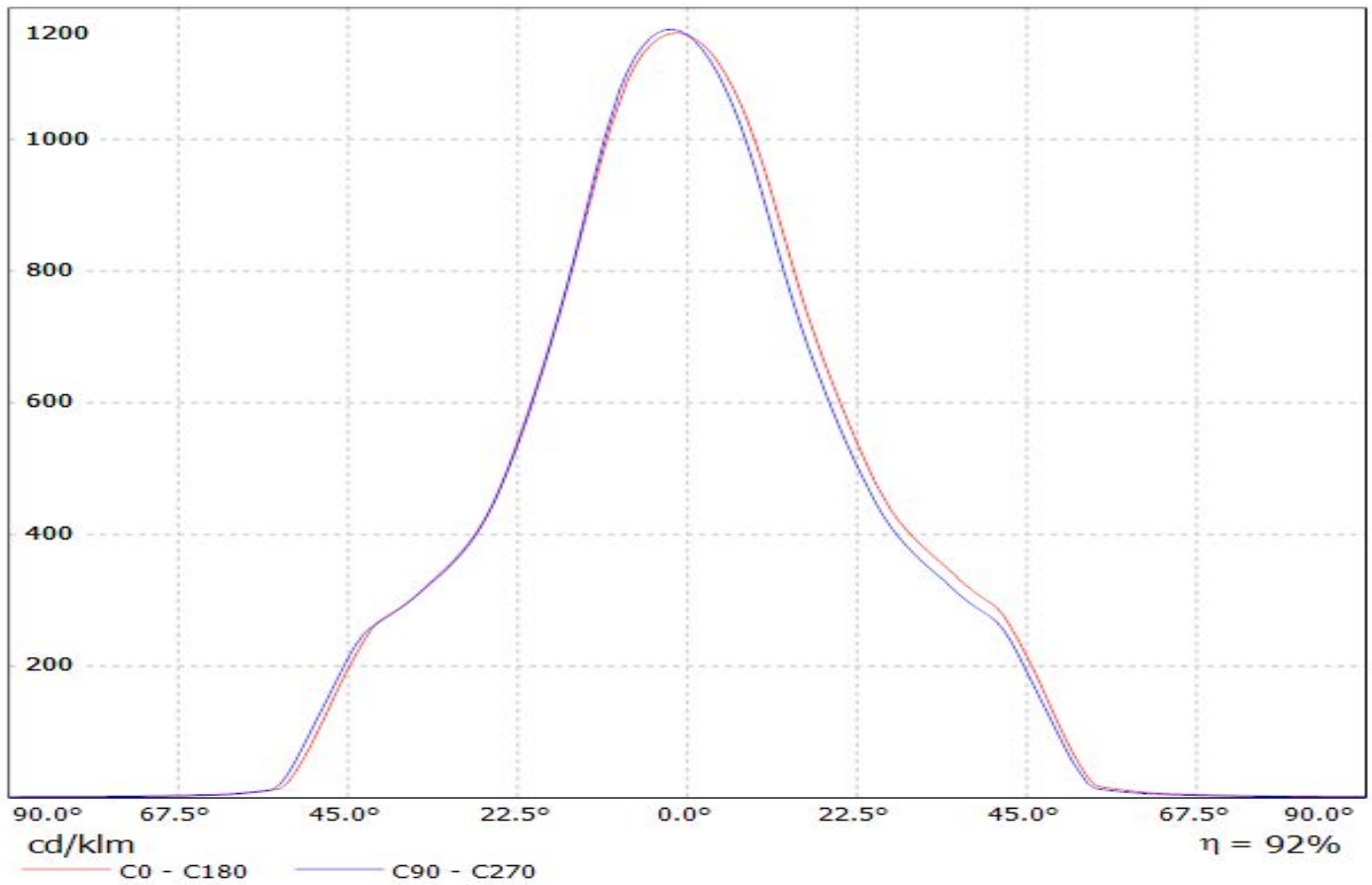

Luminaire: LEDiL Oy F13401_ANGELINA-M_(WU-M-462-827)

Lamps: 1 x Vossloh_WU-M-462-827_1116.7lm@250mA_P=8.9943W_I=249.8mA

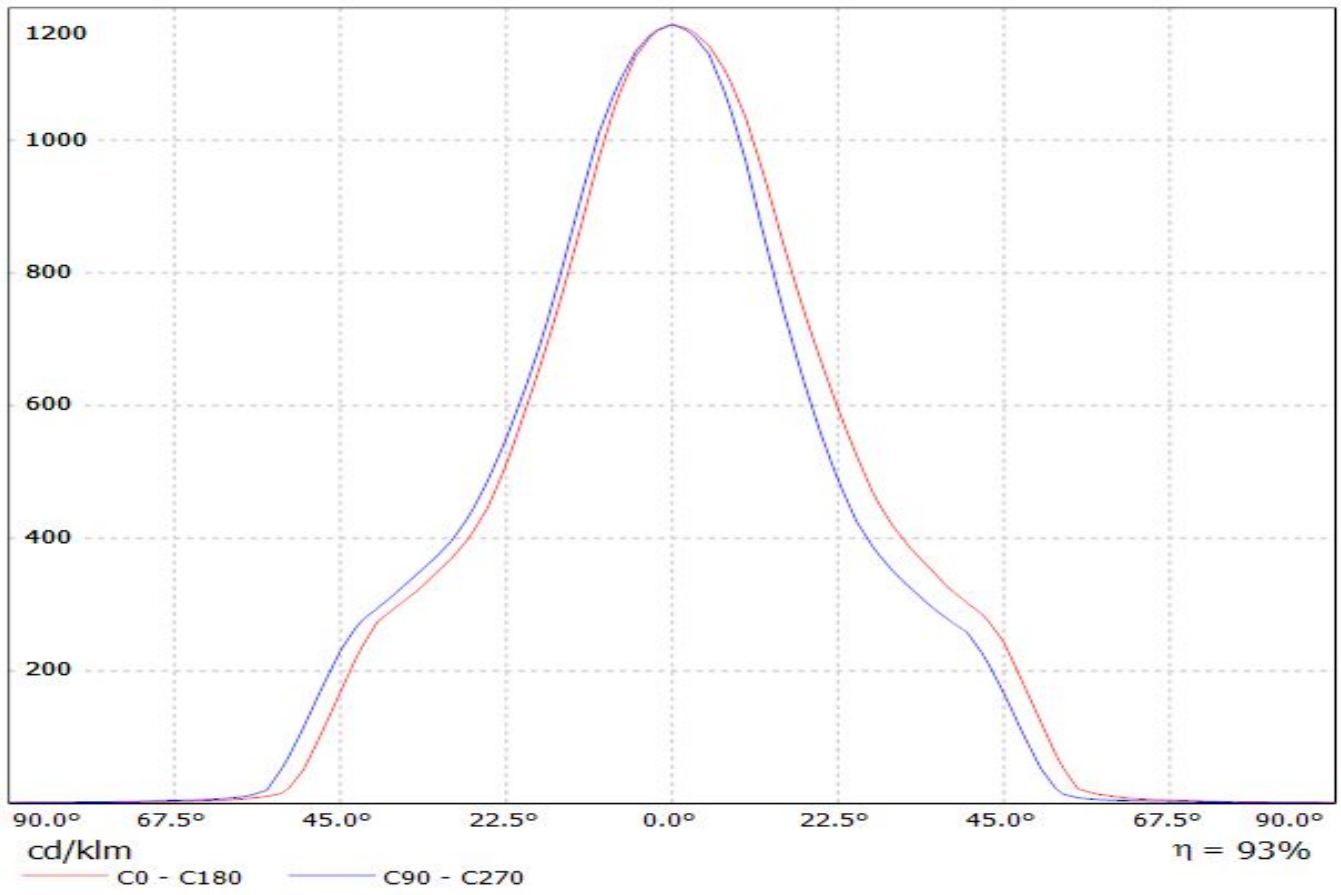

Luminaire: LEDiL Oy F13401_ANGELINA-M_(WU-M-464-827)

Lamps: 1 x Vossloh_WU-M-464-827_1452.93lm@250mA_P=11.6939W_I=249.8mA

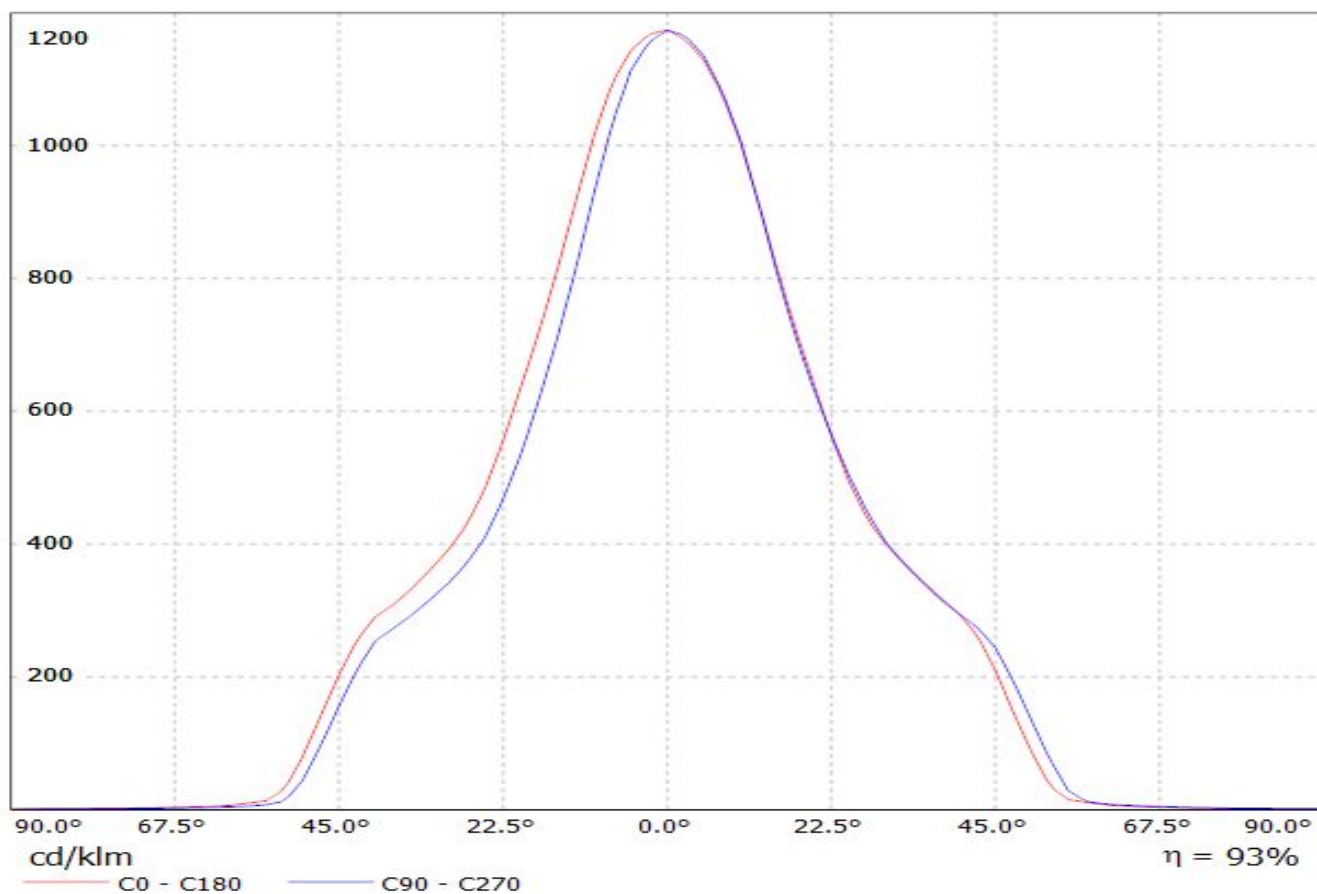

Luminaire: LEDiL Oy F13401_ANGELINA-M_(PrevaLED_LES23) Eff.94%
Lamps: 1 x OSRAM PrevaLED_LES23_(PL-CORE-5000-930-Z3)_1102.2lm@250mA_P=9.93654W_I=249.8mA

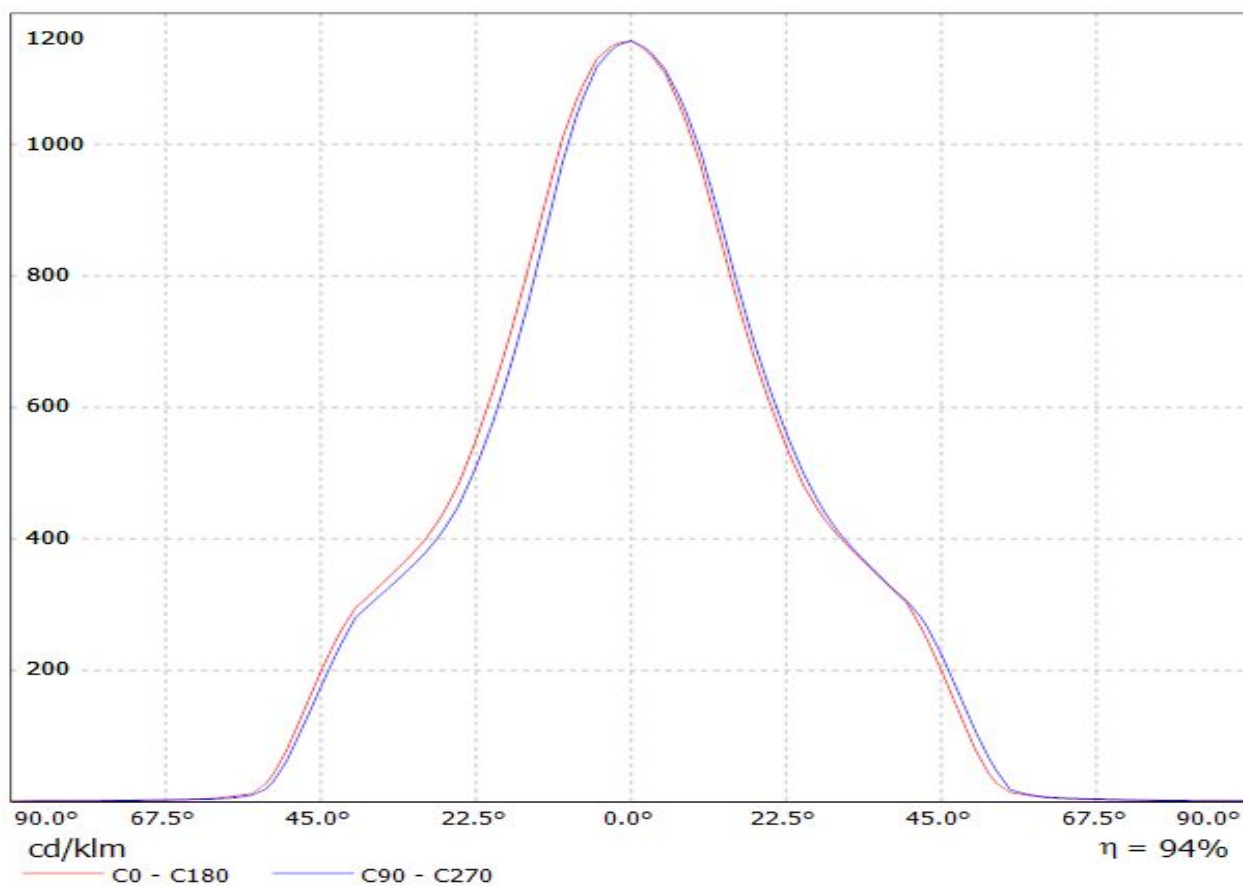

Luminaire: LEDiL Oy F13401_ANGELINA-M_(WU-M-485)

Lamps: 1 x Vossloh_Schwabe-WU-M-485_(WU-M-485-830)_1209.62lm@250mA_P=8.43849W_I=249.8mA

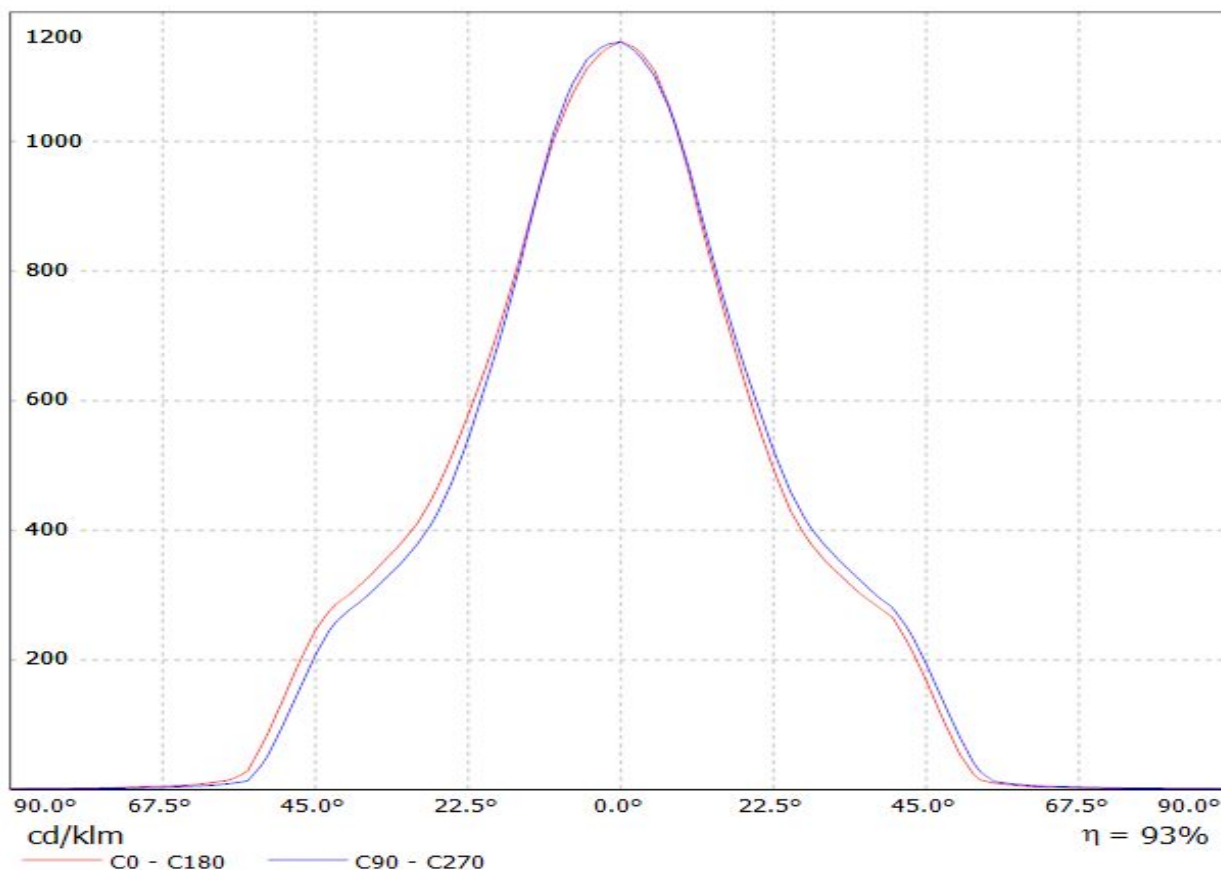

Luminaire: LEDiL Oy F13401_ANGELINA-M_(SLE_G3_LES23) Eff.90.0%

Lamps: 1 x TRIDONIC_STARK_SLE_G3_LES23_(STARK-SLE-PURE_G3-23-3000-930-SEL)_813.196lm@250mA_CCT=3000K_P=8.20018W_I=249.8mA

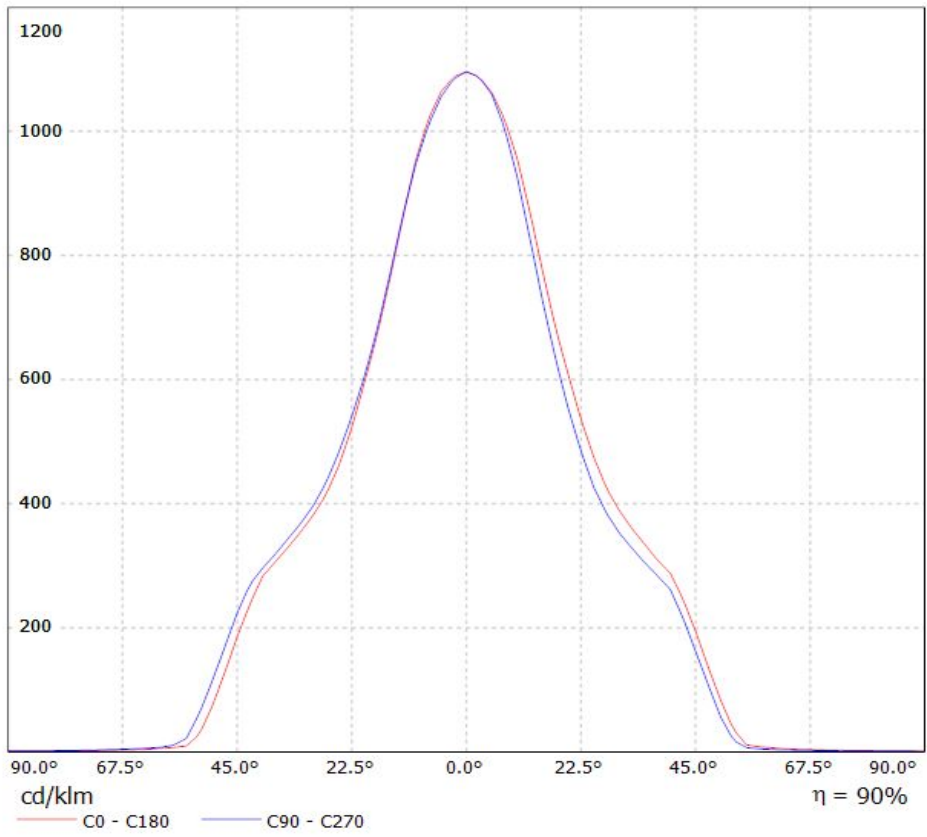

Luminaire: LEDiL Oy F13401_ANGELINA-M_(CXA3590)

Lamps: 1 x CREE_CXA3590_(CXA3590-30F-BD-R0H-0002)_2640.14lm@250mA_CCT=3000K_P=16.3941W_I=249.8mA

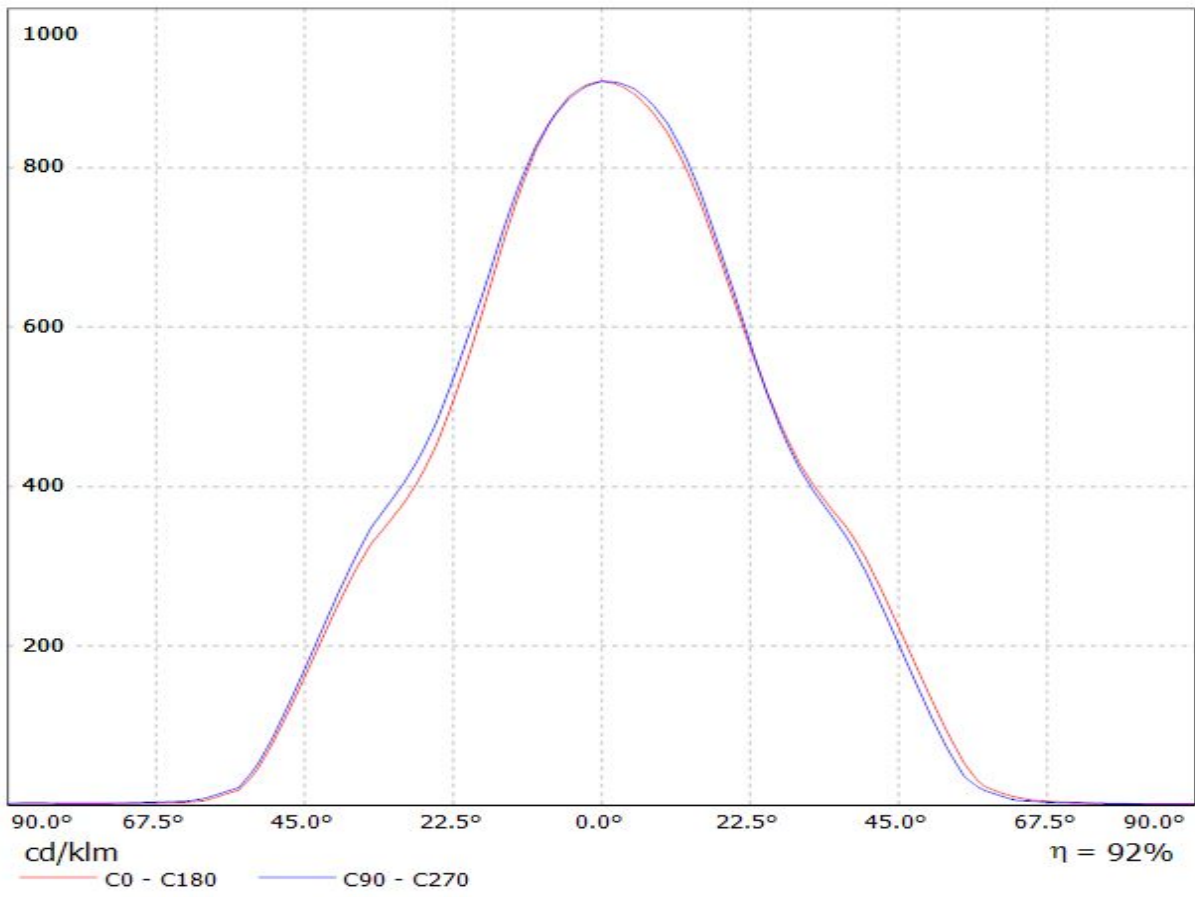

Luminaire: LEDiL Oy F13401_ANGELINA-M_(CXA1816) Eff. 93%
Lamps: 1 x CREE_CXA1816_1042.78lm@250mA_P=8.65157W_I=249.9mA

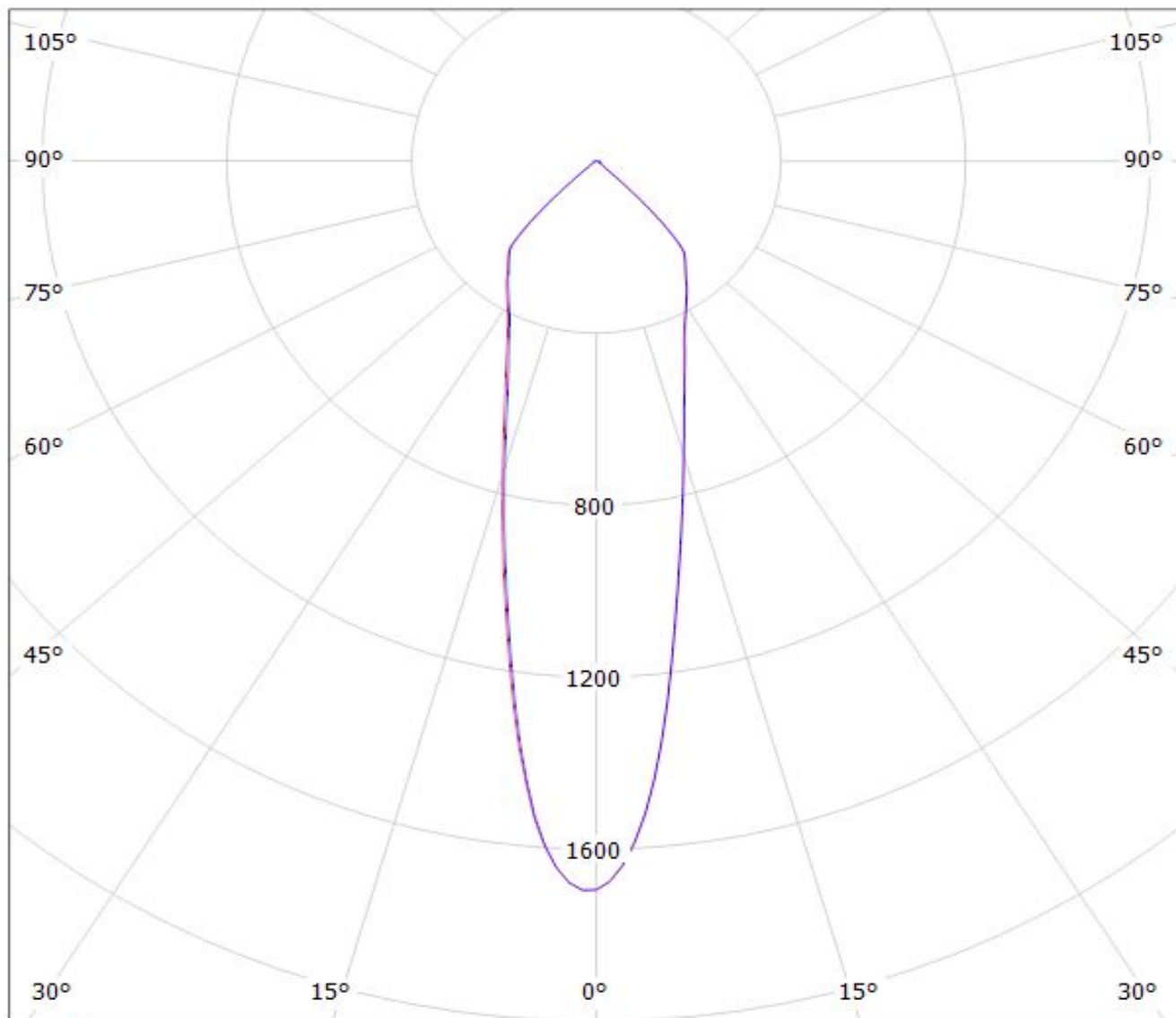

cd/klm

$\eta = 93\%$

— C0 - C180 — C90 - C270

Luminaire: LEDiL Oy F13401_ANGELINA-M_(PrevaLED_LES9) Eff.93%

Lamps: 1 x OSRAM PrevaLED_LES9_(PL-CORE-1100-830-Z3)_507.9lm@100mA_P=4.5039W_I=100.1mA

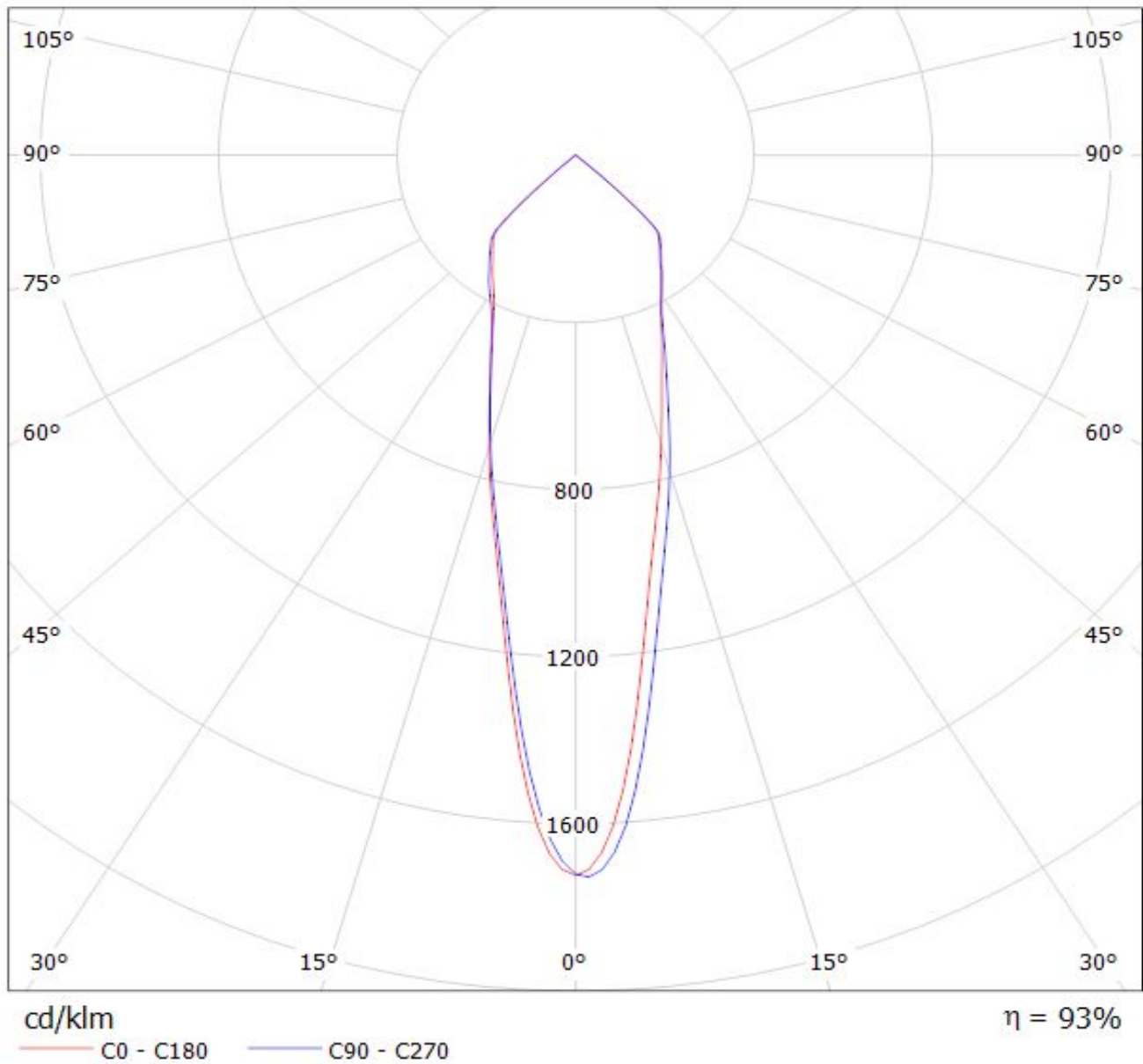

Luminaire: LEDiL Oy F13401_ANGELINA-M_(NSBxL121A) Eff.90.8%

Lamps: 1 x NICHIA_NSBxL121A_(NSBLL121AE)_805.561lm@250mA_CCT=3000K_P=7.3681W_I=249.8mA

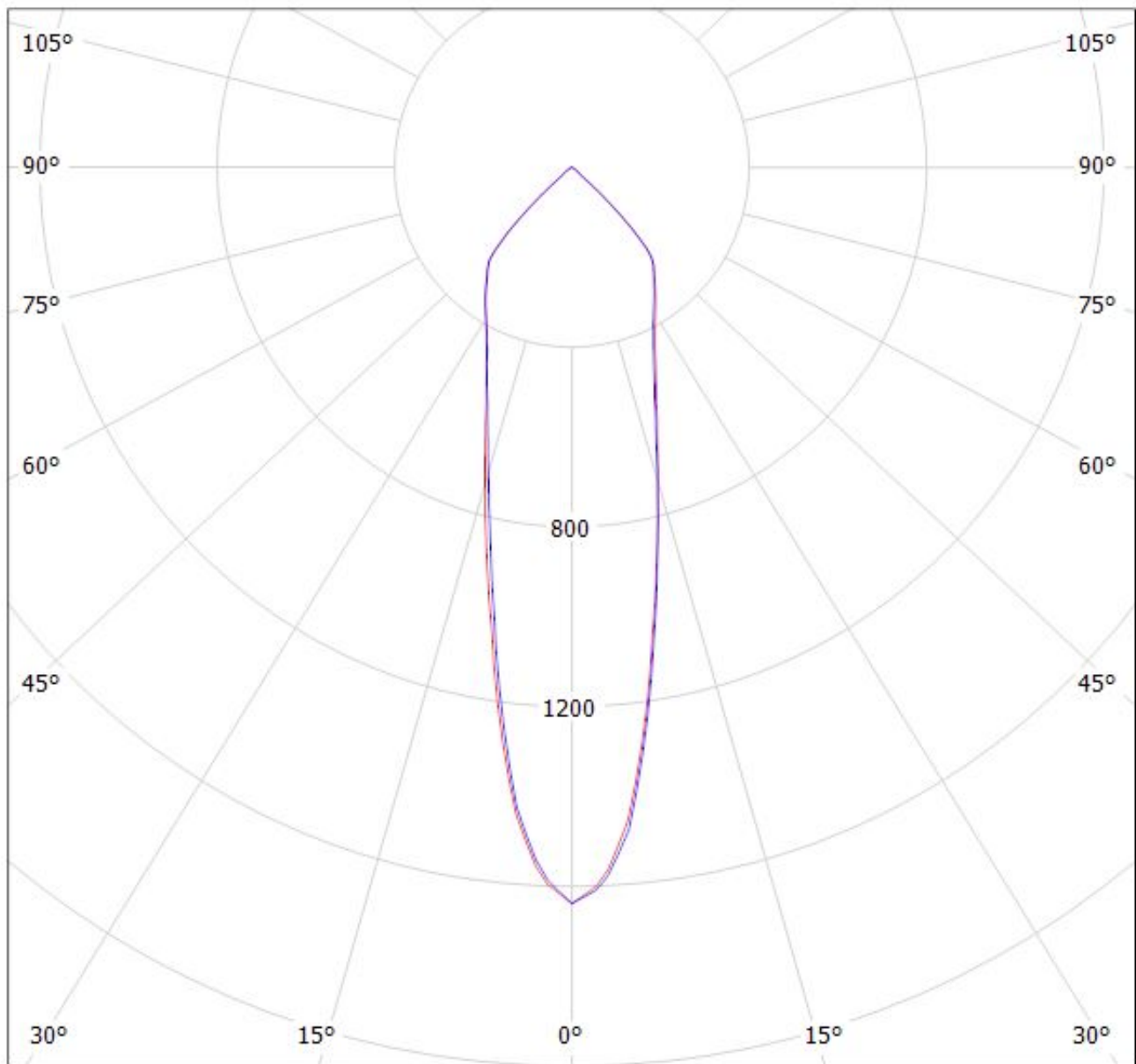

cd/klm

— C0 - C180

— C90 - C270

$\eta = 91\%$

Luminaire: LEDiL Oy F13401_ANGELINA-M_(LEP-800-827-C-AC)

Lamps: 1 x OSRAM PrevaLED Core AC (LEP-800-827-C-AC) 910lm@60mA U:230V P:14W

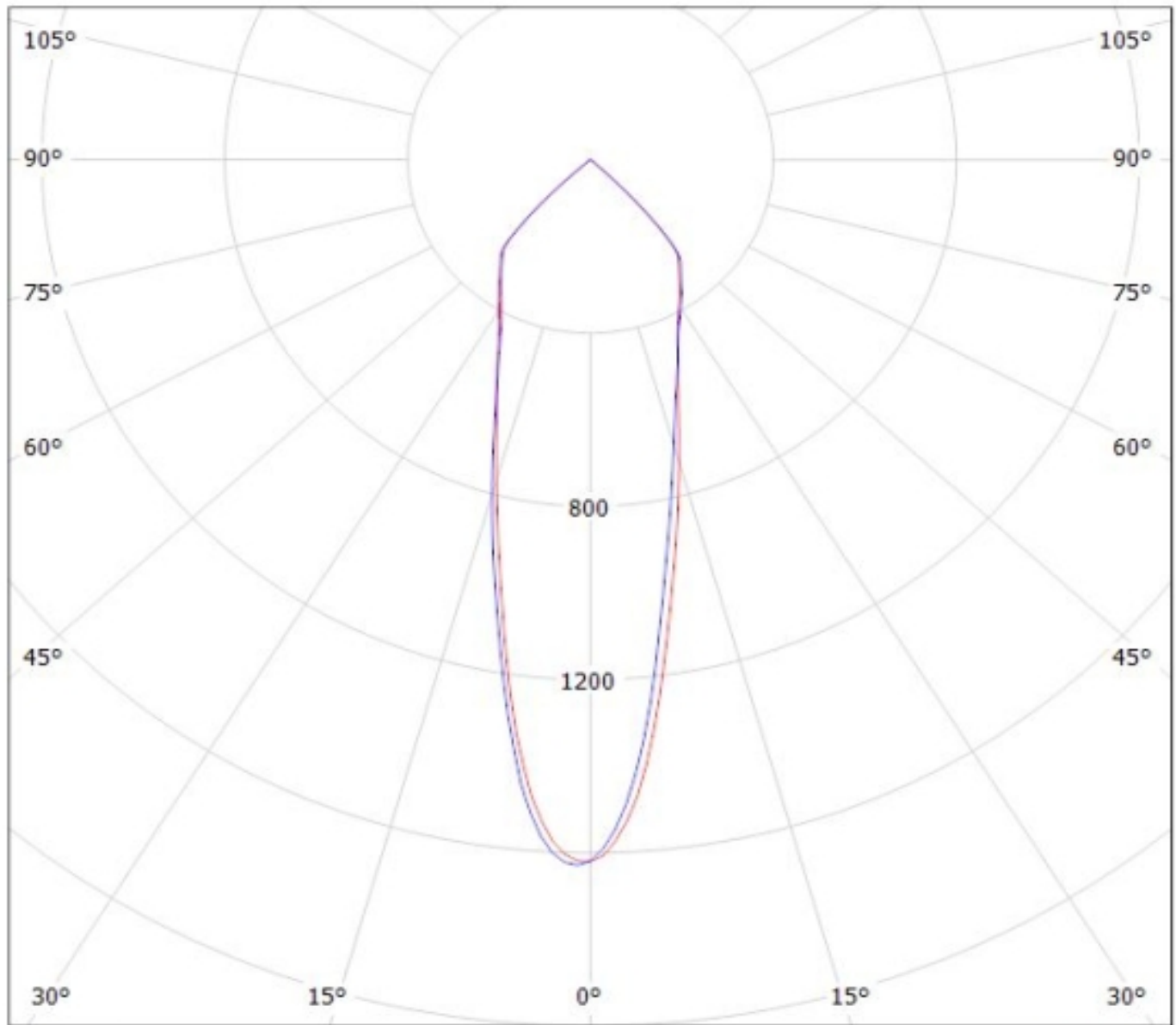

cd/klm

— C0 - C180 — C90 - C270

$\eta = 93\%$

Luminaire: LEDiL Oy F13401_ANGELINA-M_(LUXEON_COB_1205) Eff.92.4%

Lamps: 1 x LUXEON_COB_1205_(LHC1-3080-1205)_1084.49lm@250mA_CCT=3000K_P=8.31784W_I=249.8mA

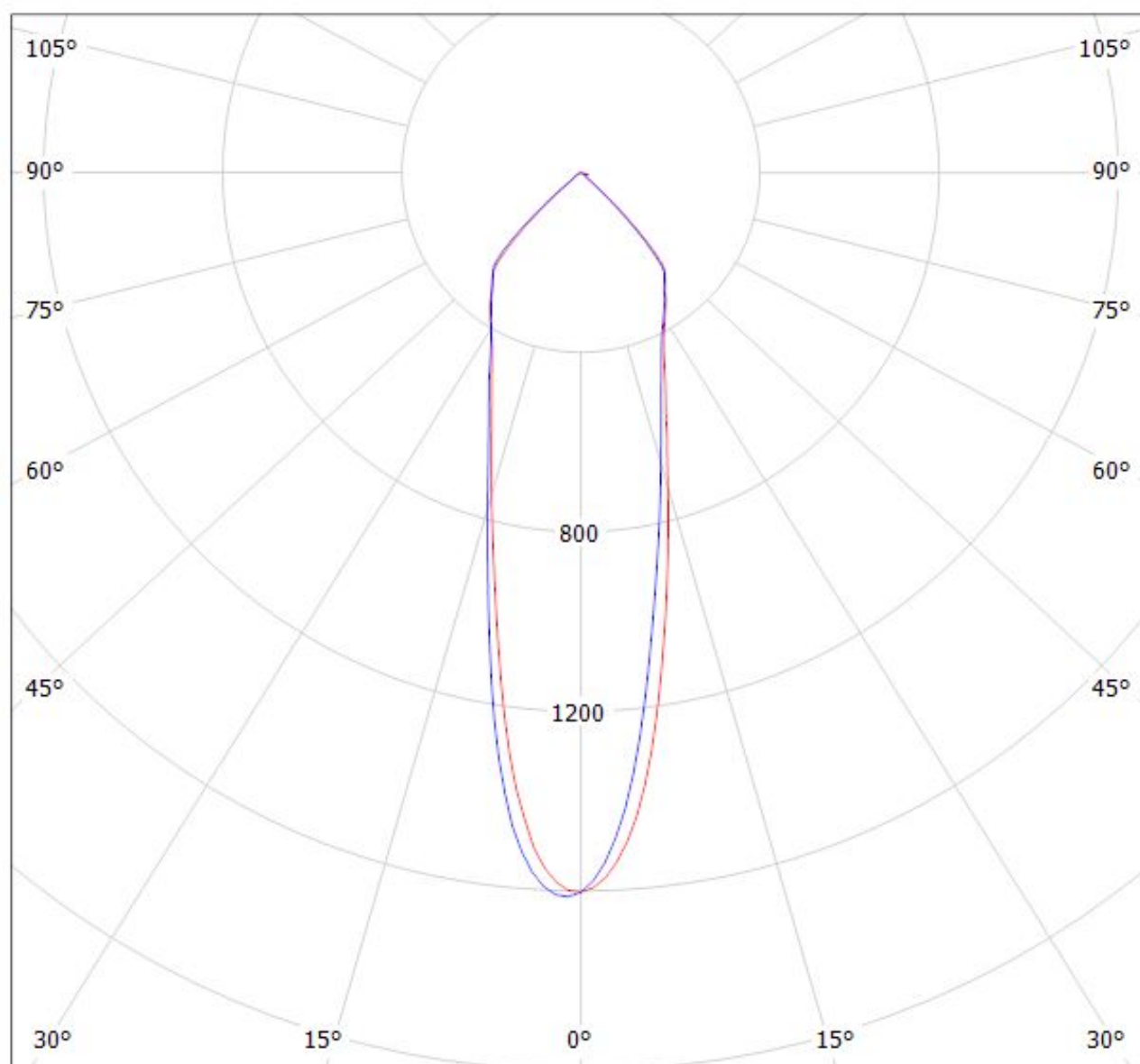

cd/klm

$\eta = 92\%$

— C0 - C180

— C90 - C270

Luminaire: LEDiL Oy F13401_ANGELINA-M_(LG_COB-10W) Eff.92.4%
Lamps: 1 x LG_COB-10W_1024lm@250mA_CCT=5090K_P=9W_I=250mA

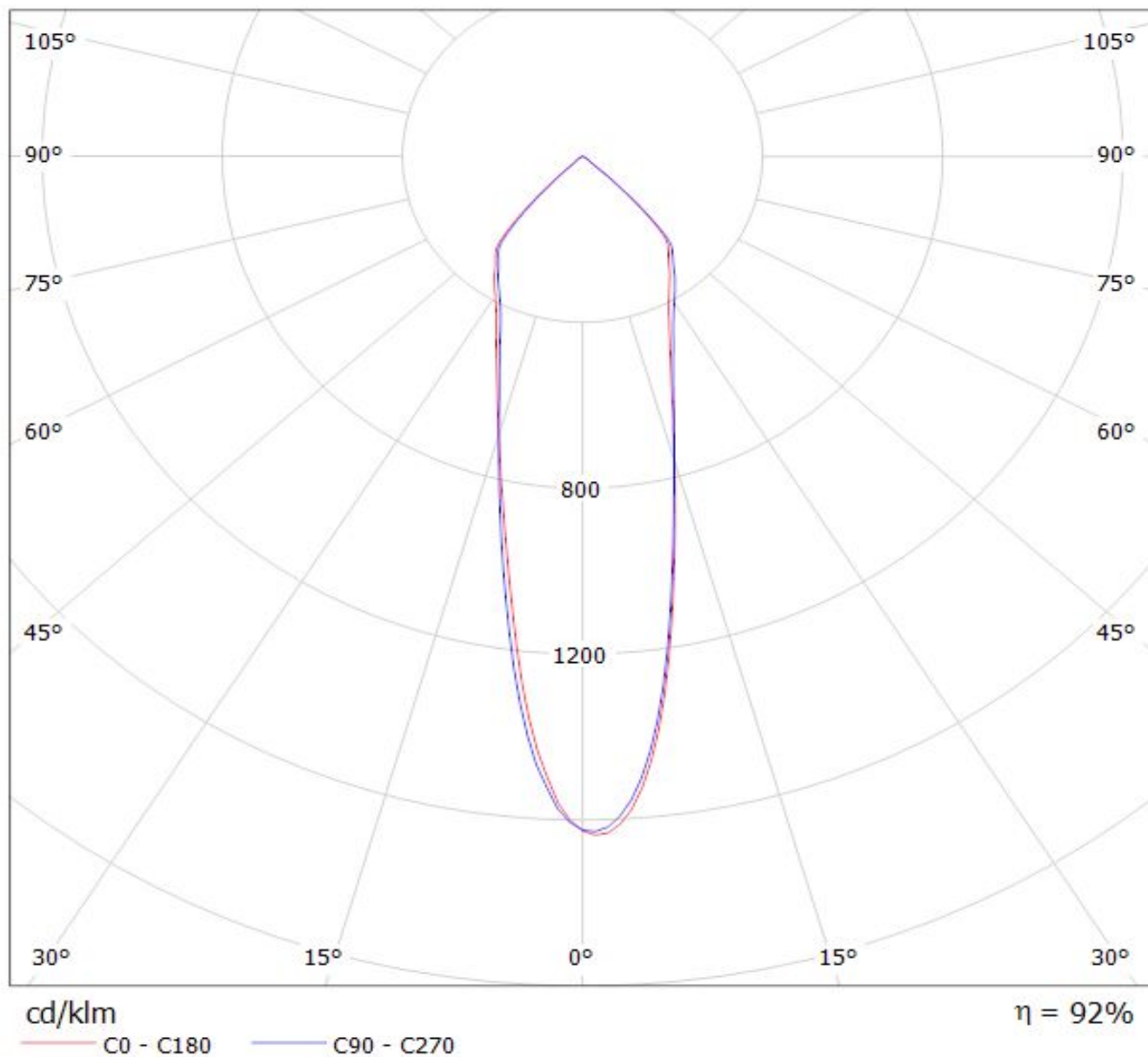

LEDiL Oy C13401_ANGELINA-M_(LUXEON_K12) Eff.94.0% / LDC (Polar)

Luminaire: LEDiL Oy C13401_ANGELINA-M_(LUXEON_K12) Eff.94.0%
Lamps: 1 x LUXEON_K12 (929.543lm@250mA)

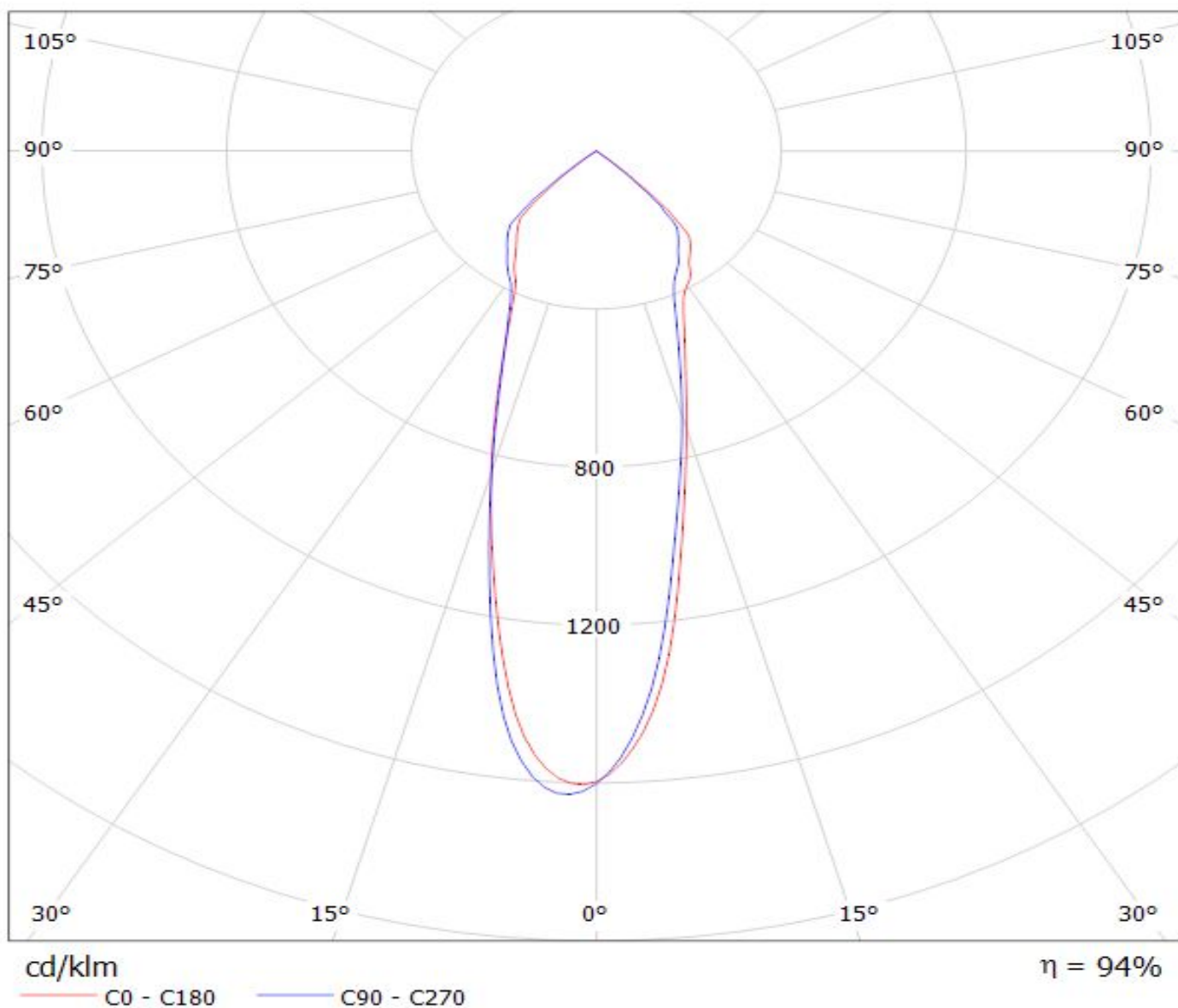

Luminaire: LEDiL Oy F13401_ANGELINA-M_(BXRA_ES) Eff.92.6%

Lamps: 1 x BXRA_ES_(BXRA-W1203_102820-3110)_281.549lm@250mA_P=4.09397W_I=249.8mA

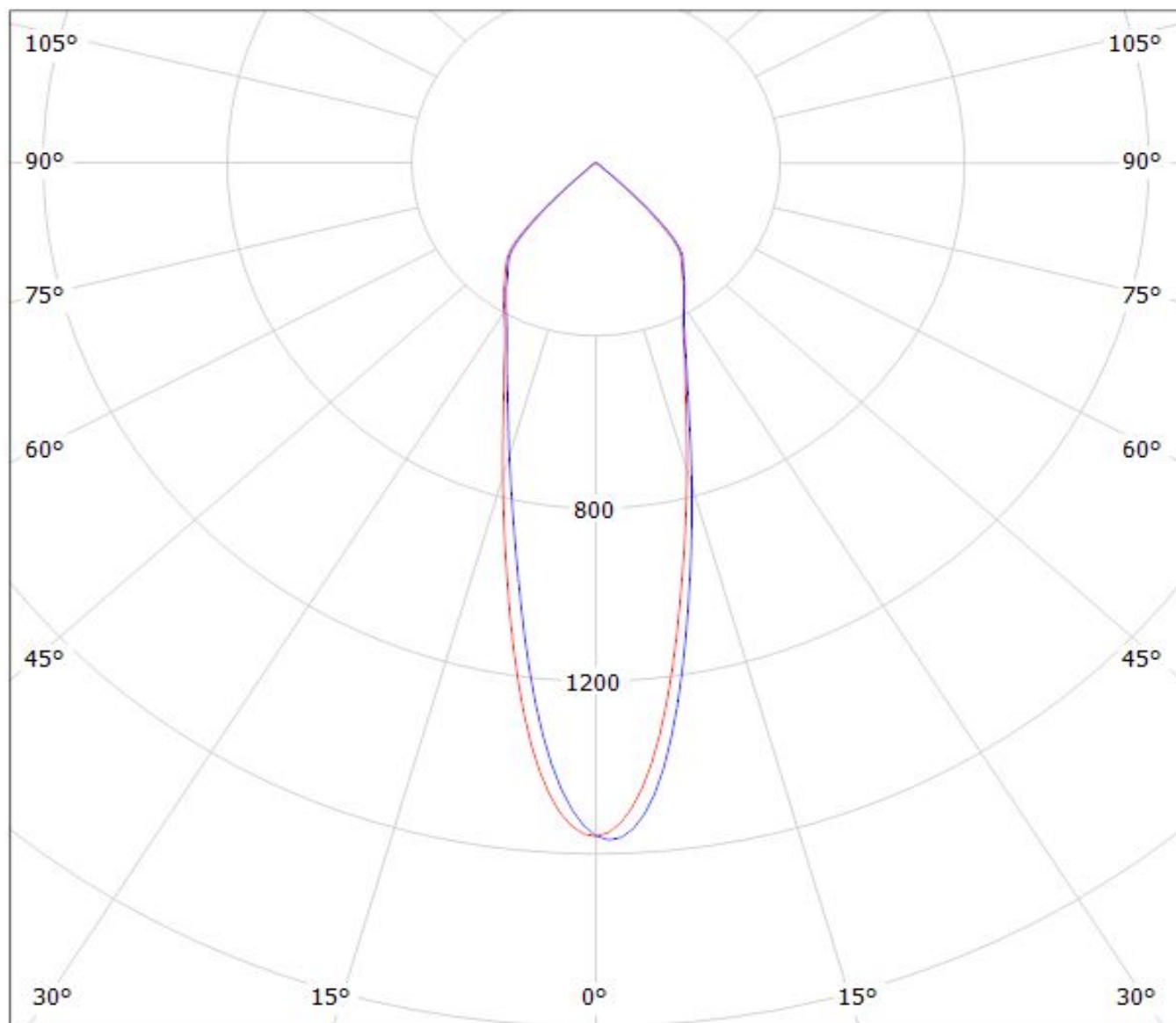

cd/klm

— C0 - C180

— C90 - C270

$\eta = 93\%$

Luminaire: LEDiL Oy F13401_ANGELINA-M_(MEGAZENIGATA) Eff.92.5%
Lamps: 1 x SHARP_MEGAZENIGATA_(GW6DME30NFC)_1238.26lm@250mA_CCT=3000K_P=11.1211W_I=249.8mA

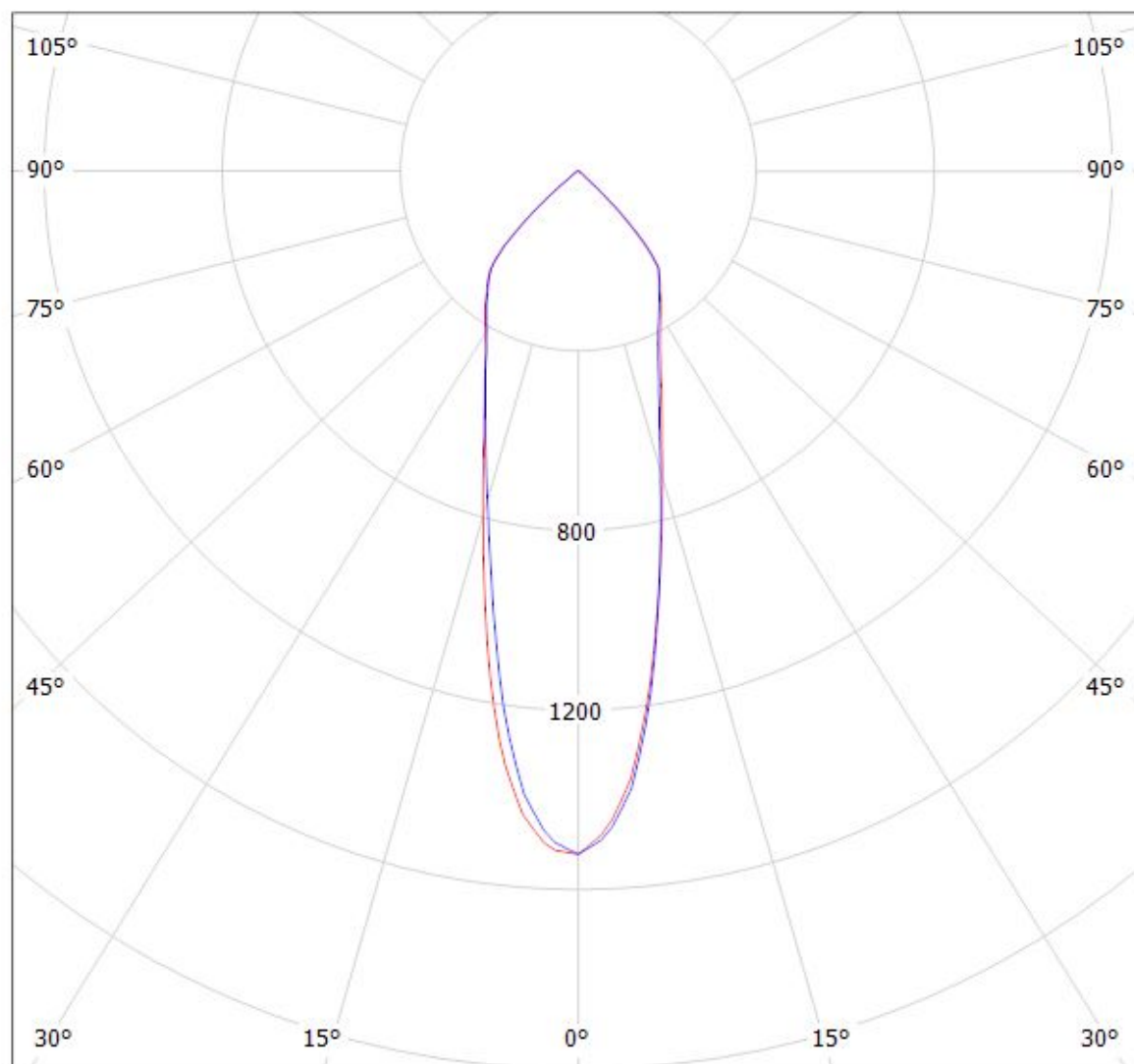

cd/klm

— C0 - C180 — C90 - C270

$\eta = 93\%$

Luminaire: LEDiL Oy F13401_ANGELINA-M_(LUXEON_CoB_1205) Eff: 94 %

Lamps: 1 x LUXEON CoB 1205 (LHC1-3080-1205) 1082lm@250mA CCT=3000K P=8.3W I=250mA

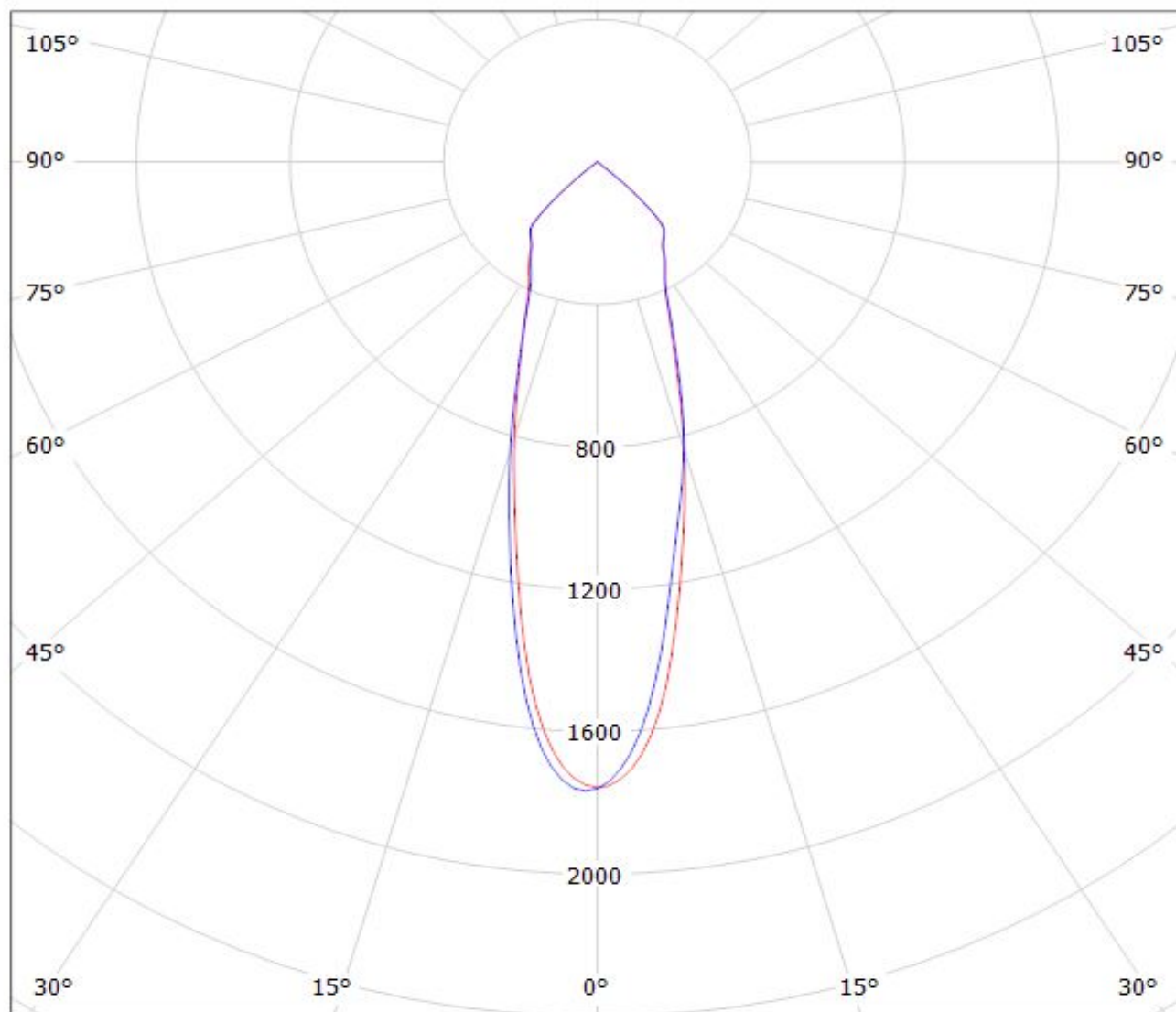

cd/klm

— C0 - C180

— C90 - C270

$\eta = 93\%$

Luminaire: LEDiL Oy F13401_ANGELINA-M_(CLL030) Eff.92.3%

Lamps: 1 x CITIZEN_CLL030_(CLL030-1205A5-303H1A7)_758.588lm@250mA_CCT=5090K_P=8.61086W_I=249.8mA

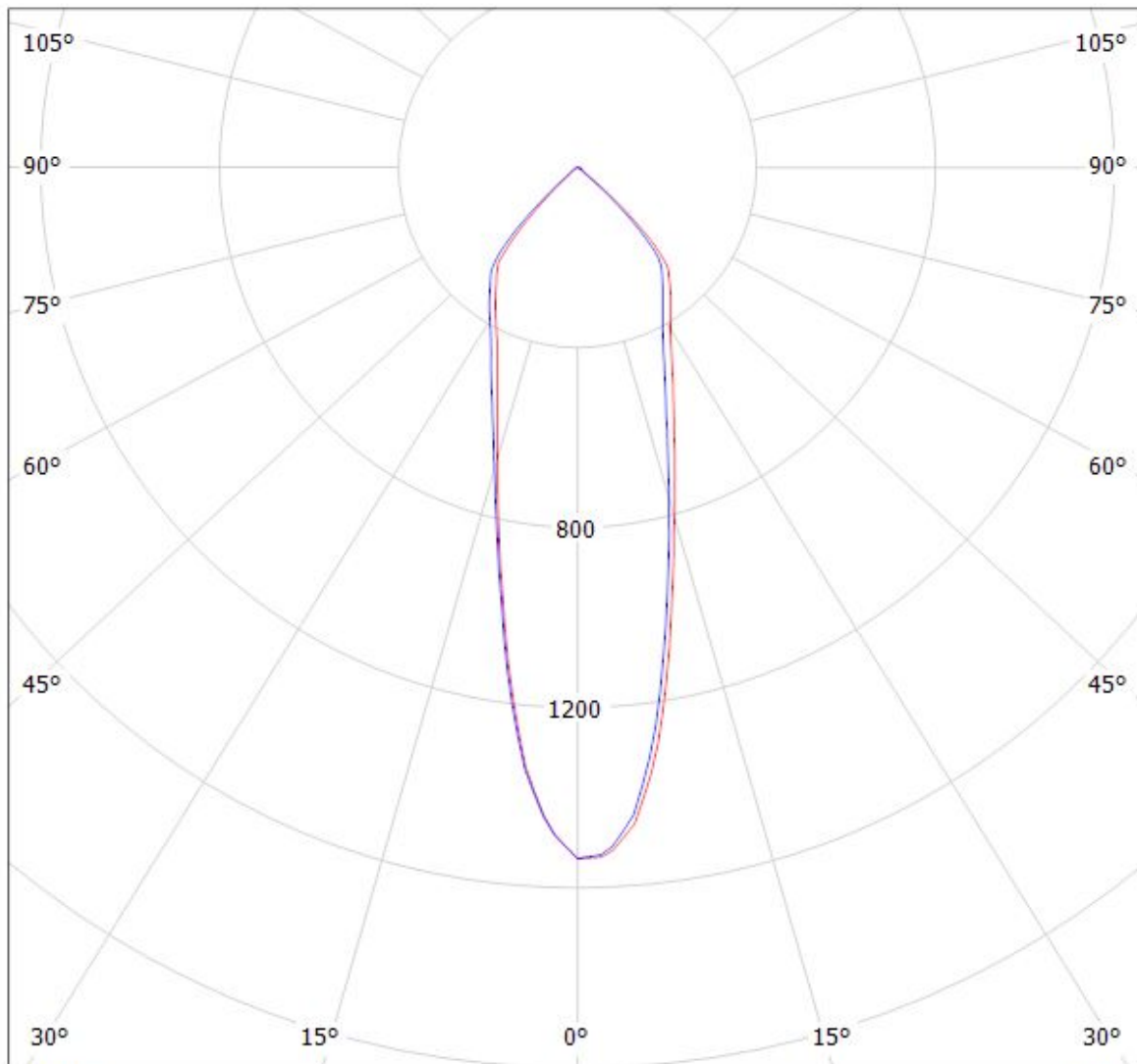

cd/klm

$\eta = 92\%$

— C0 - C180

— C90 - C270

Luminaire: LEDiL Oy F13401_ANGELINA-M_(LUXEON_COB_1208) Eff.92.5%

Lamps: 1 x LUXEON_COB_1208_(LHC1-3080-1208)_1015.13lm@250mA_CCT=3000K_P=8.15972W_I=249.8mA

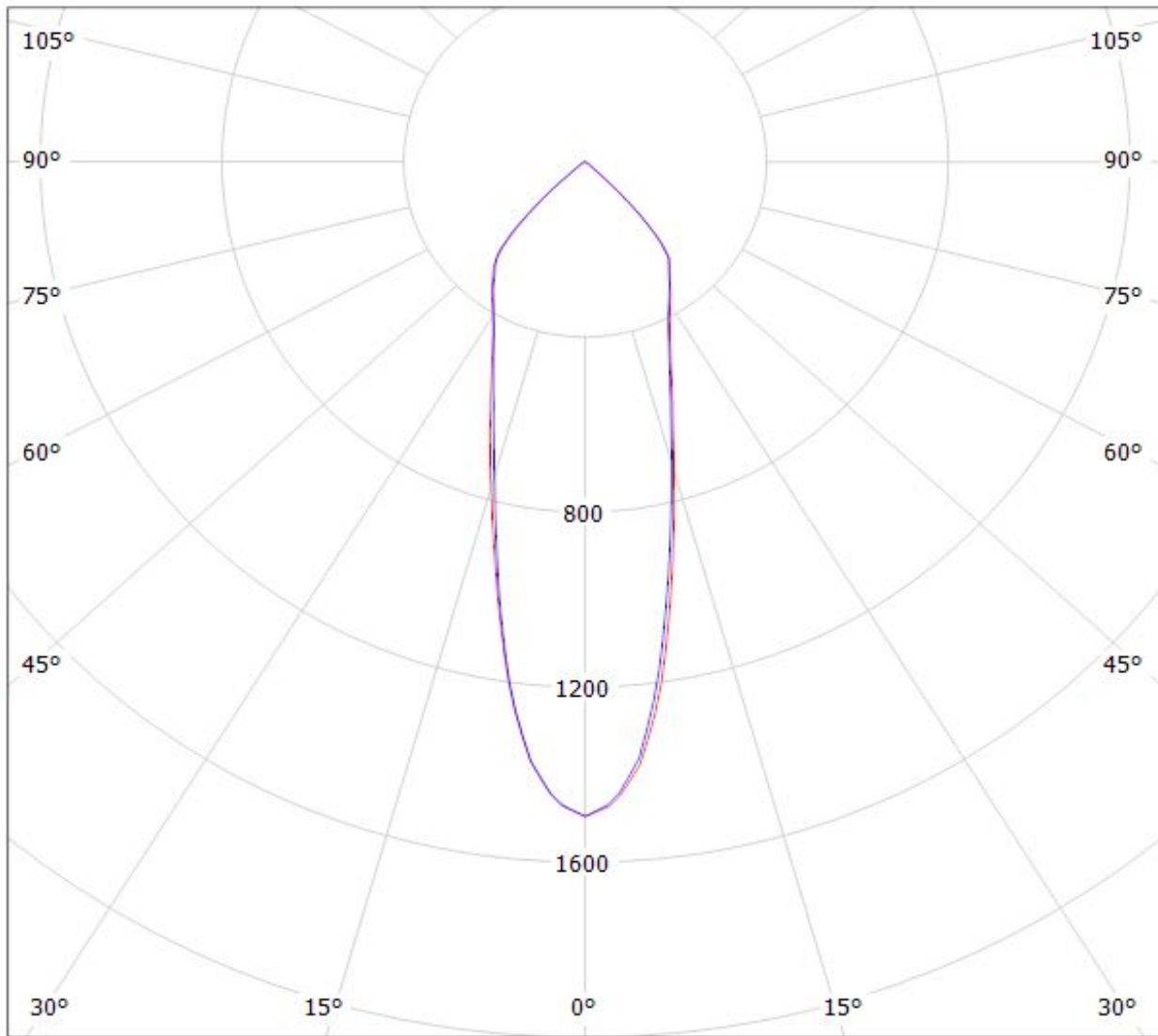

cd/klm

— C0 - C180

— C90 - C270

$\eta = 93\%$

Luminaire: LEDiL Oy F13401_ANGELINA-M_(NSCxJ216A) Eff.93.5%
Lamps: 1 x NICHIA_NSCxJ216A_(NSCLJ216AE)_949.847lm@250mA_CCT=3000K_P=7.96937W_I=249.8mA

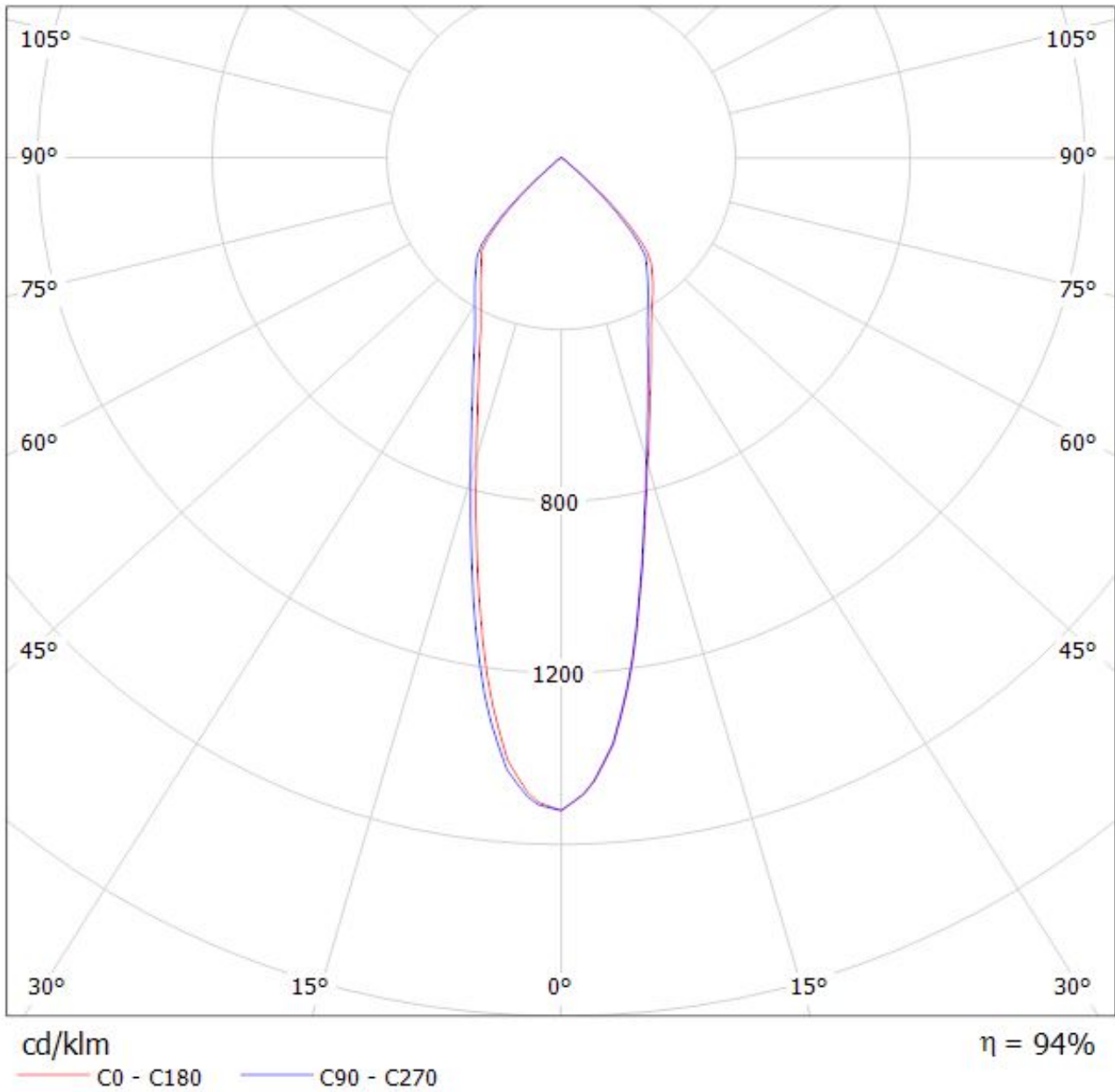

LEDiL Oy C13401_ANGELINA-M_(LUXEON_K16) Eff.93.6% / LDC (Polar)

Luminaire: LEDiL Oy C13401_ANGELINA-M_(LUXEON_K16) Eff.93.6%

Lamps: 1 x LUXEON_K16 (1204.33lm@250mA)

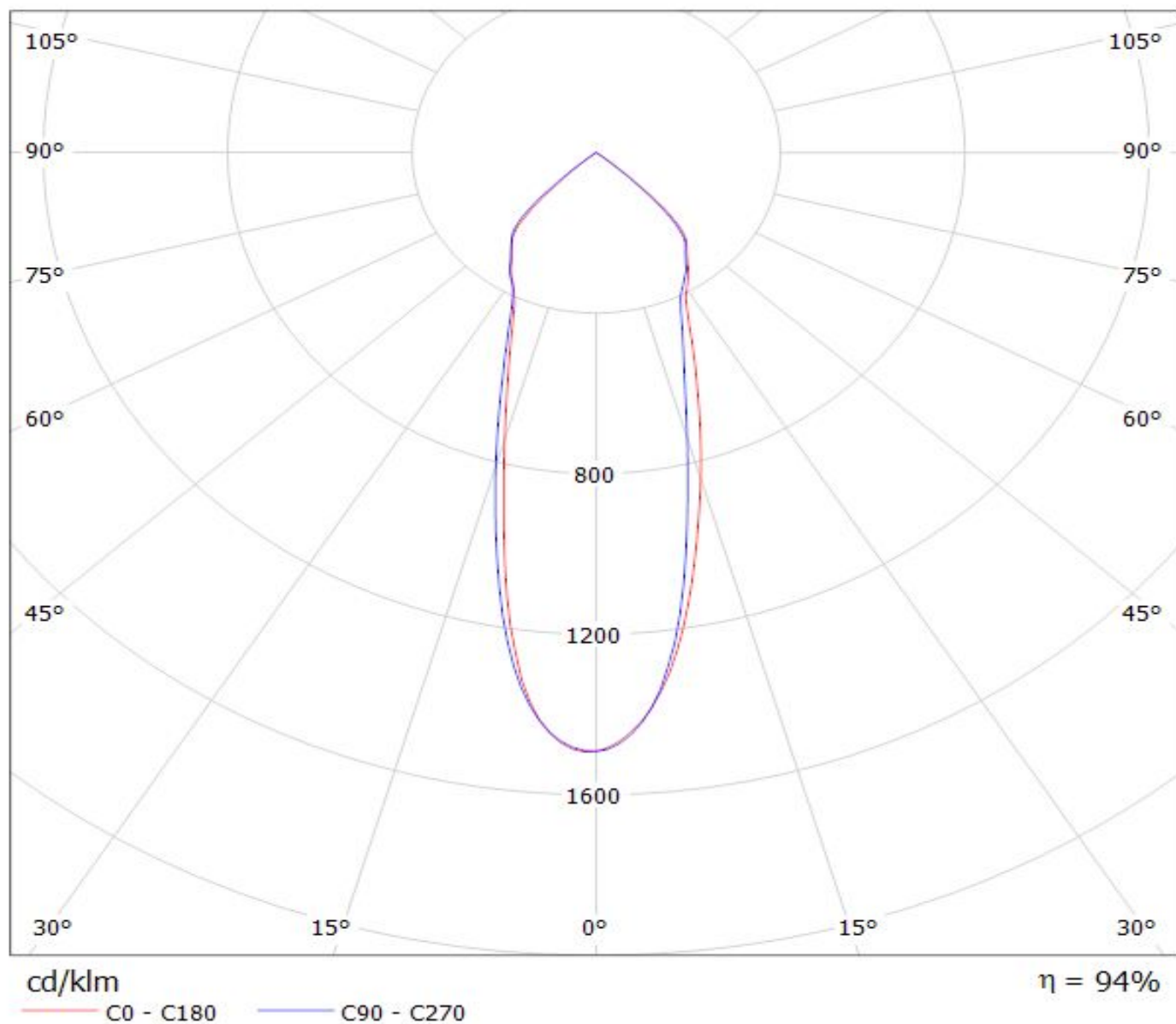

Luminaire: LEDiL Oy F13401_ANGELINA-M_(MegaZenigata) 92.0%
Lamps: 1 x MegaZenigata_GW6DME (518.495lm@100mA)

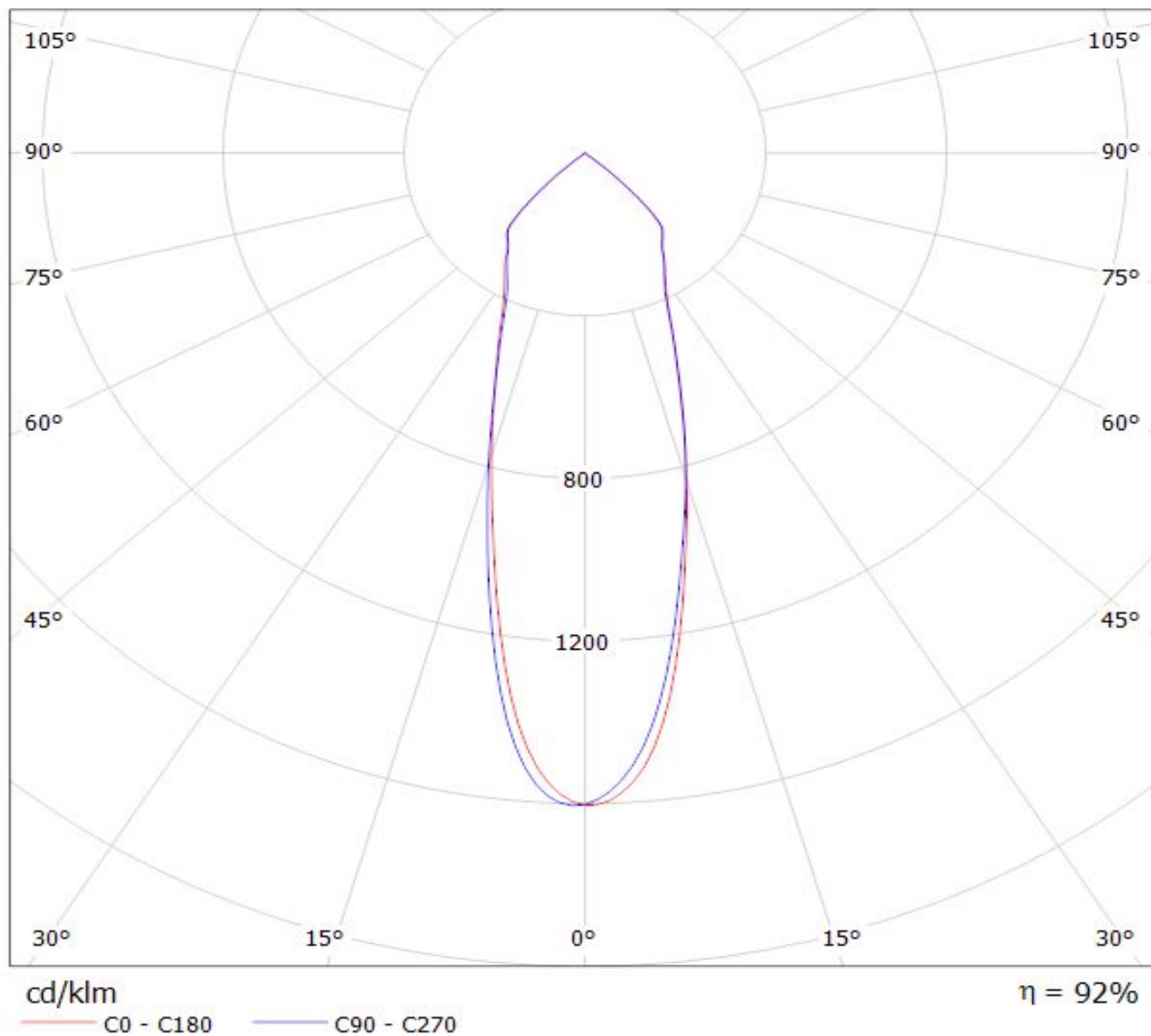

Luminaire: LEDiL Oy F13401_ANGELINA-M (LUXEON_CoB_1208) Eff: 93 %
Lamps: 1 x Luxeon CoB 1208 (LHC1-3080-1208) 1029lm@250mA CCT=3000K P=8.2W I=250mA

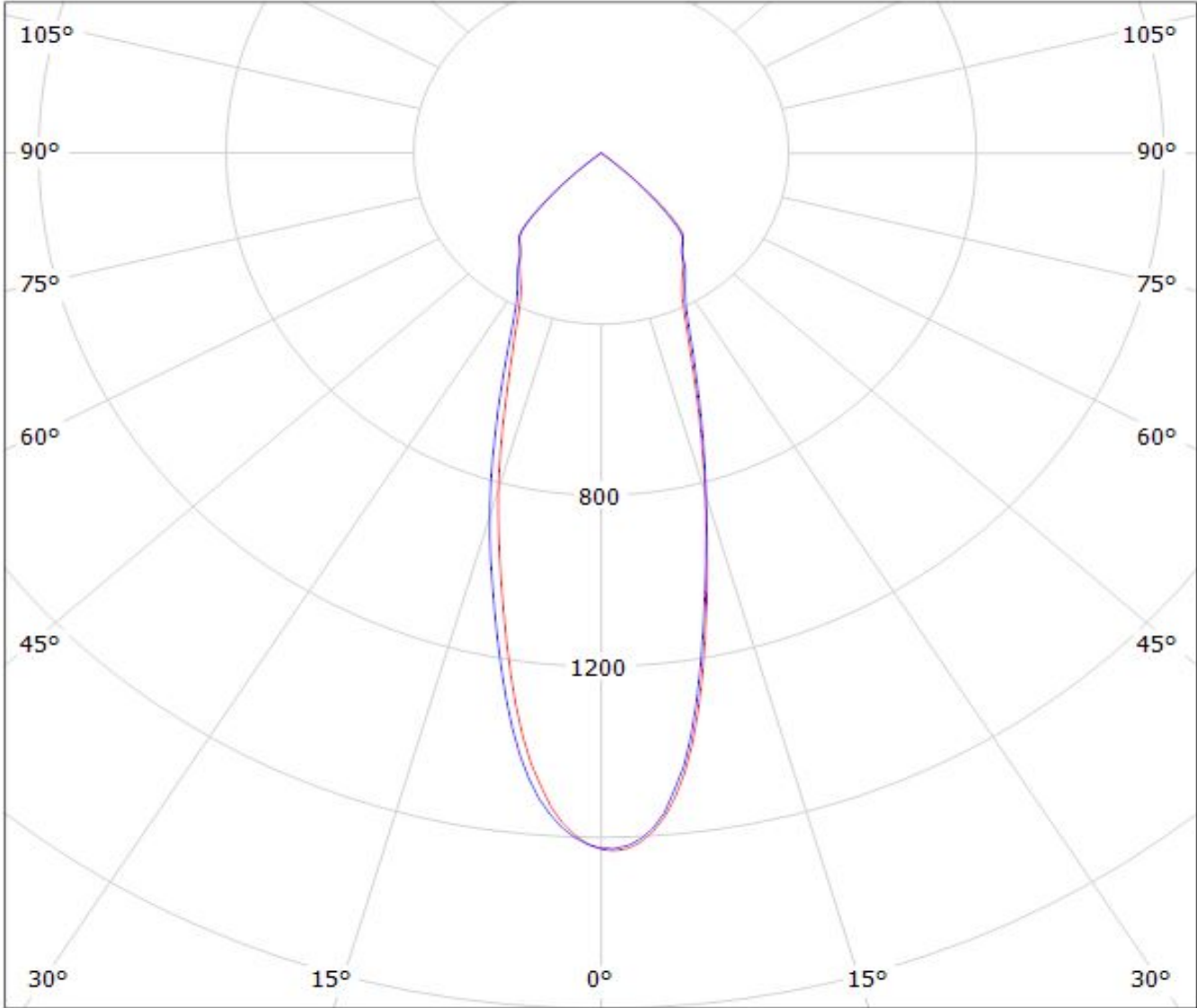

cd/klm

— C0 - C180 — C90 - C270

$\eta = 93\%$

Luminaire: LEDiL Oy F13401_ANGELINA-M_(STARK_SLE_G2_LES19) Eff.91.6%
Lamps: 1 x TRIDONIC STARK SLE G2 LES19 830 CLA 964.643lm@250mA CCT=3000K P=8W I=250mA

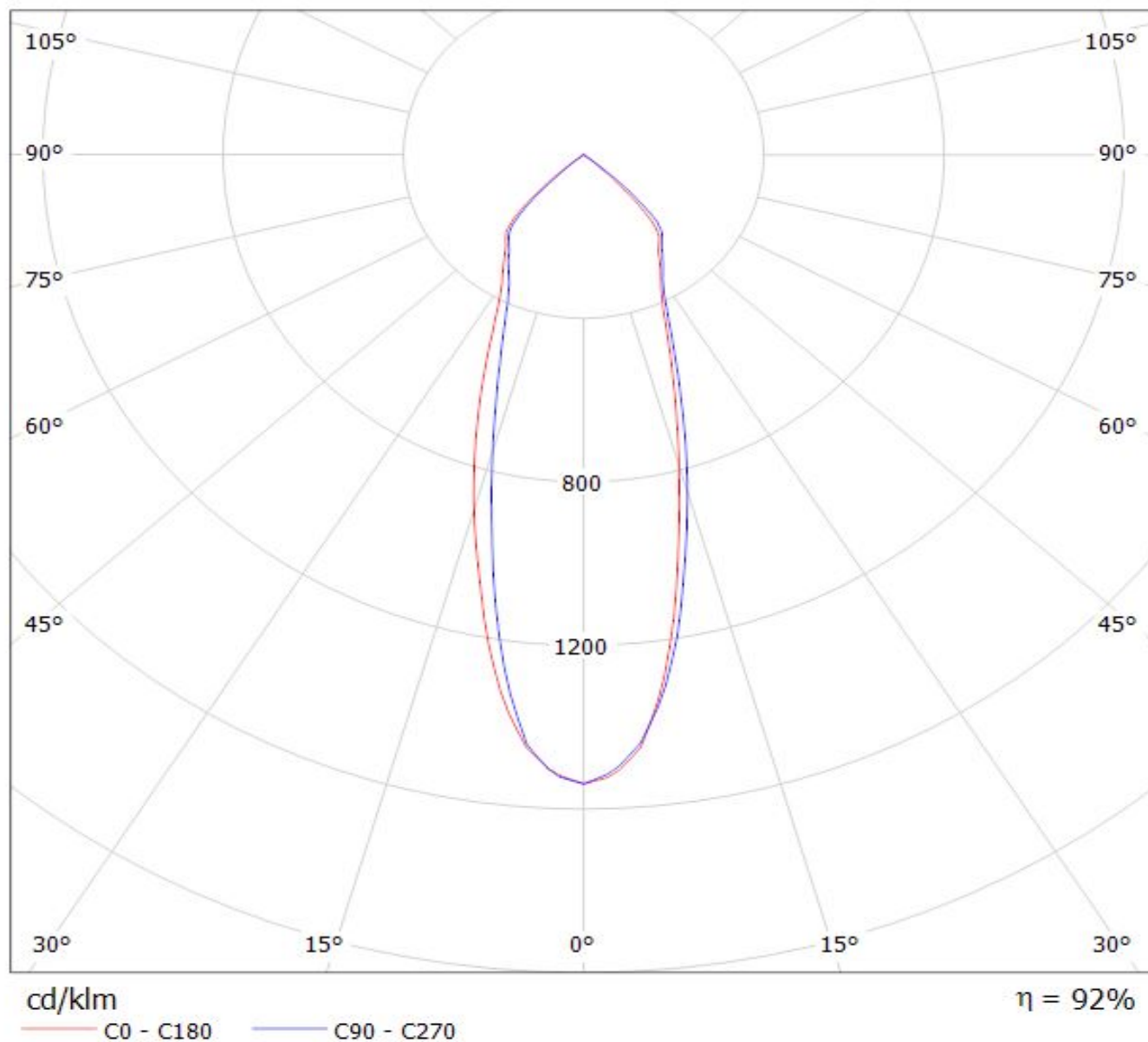

Luminaire: LEDil Oy F13401_ANGELINA-M_(Soleriq_S13) Efficiency=94%

Lamps: 1 x Osram Soleriq S13 (GW KAGHB1.EM) 855lm @ 250mA CCT=3100K P=7.5W I=250mA

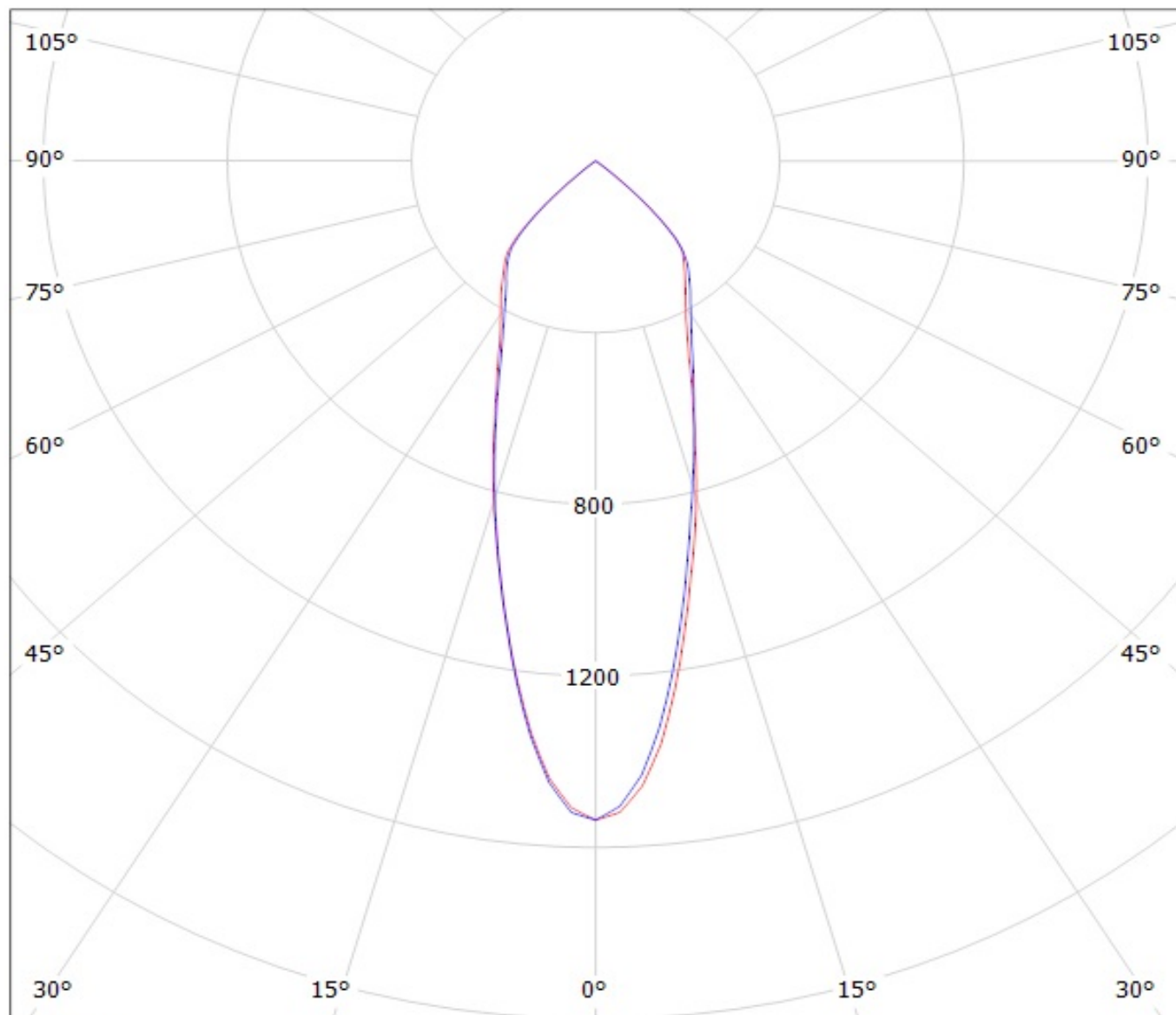

cd/klm

— C0 - C180

— C90 - C270

Luminaire: LEDiL Oy F13401_ANGELINA-M_(CXM-14)

Lamps: 1 x LUMINUS_CXM-14_1114.36lm@250mA_P=8.36106W_I=249.8mA

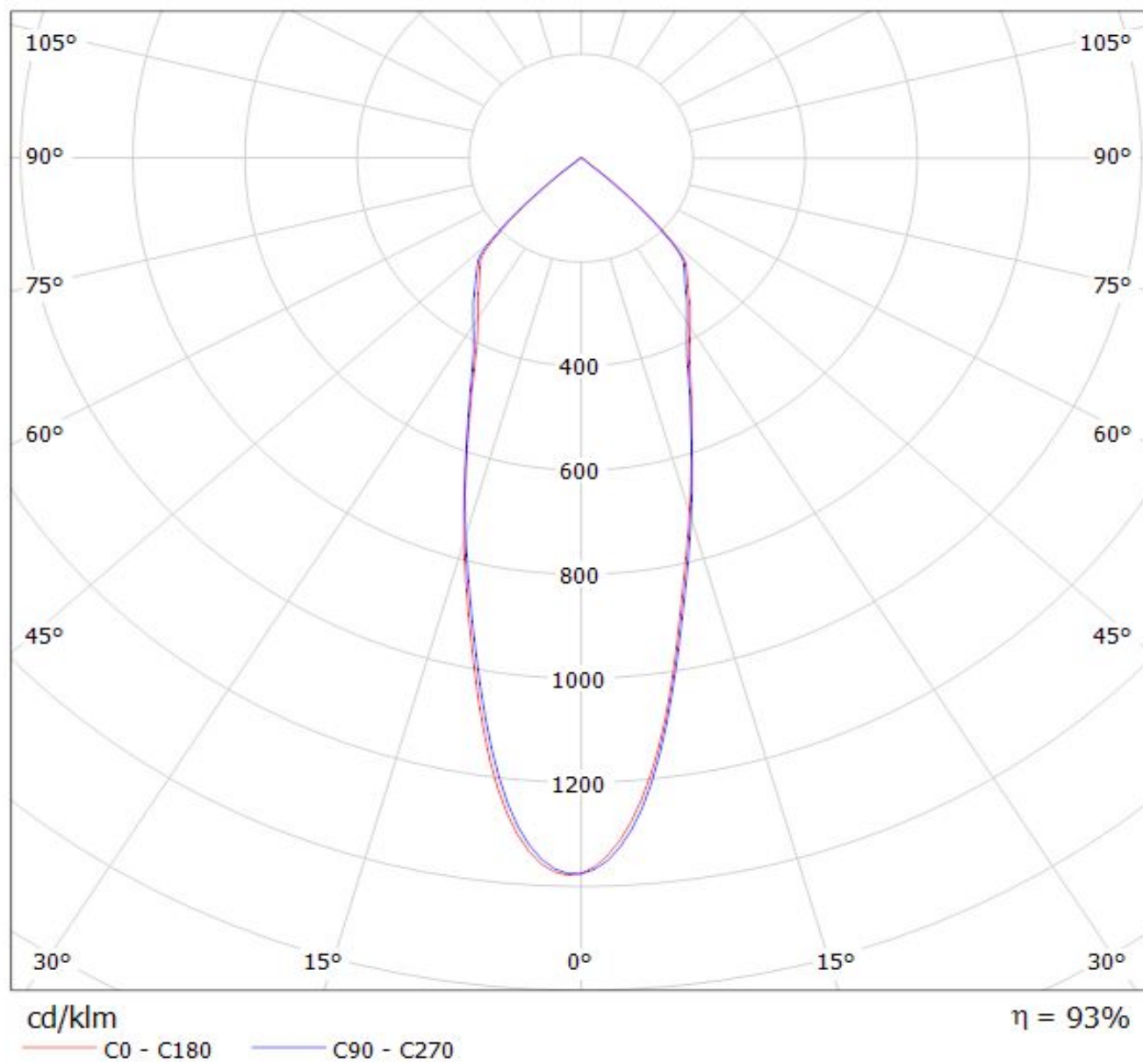

Luminaire: LEDiL Oy F13401_ANGELINA-M_(PrevaLED_Z4) Eff.93%

Lamps: 1 x Osram_PrevaLED_CORE_Z4_(PL-CORE-3000-830-Z4)_1423.93lm@250mA_P=10.7652W_I=249.9mA

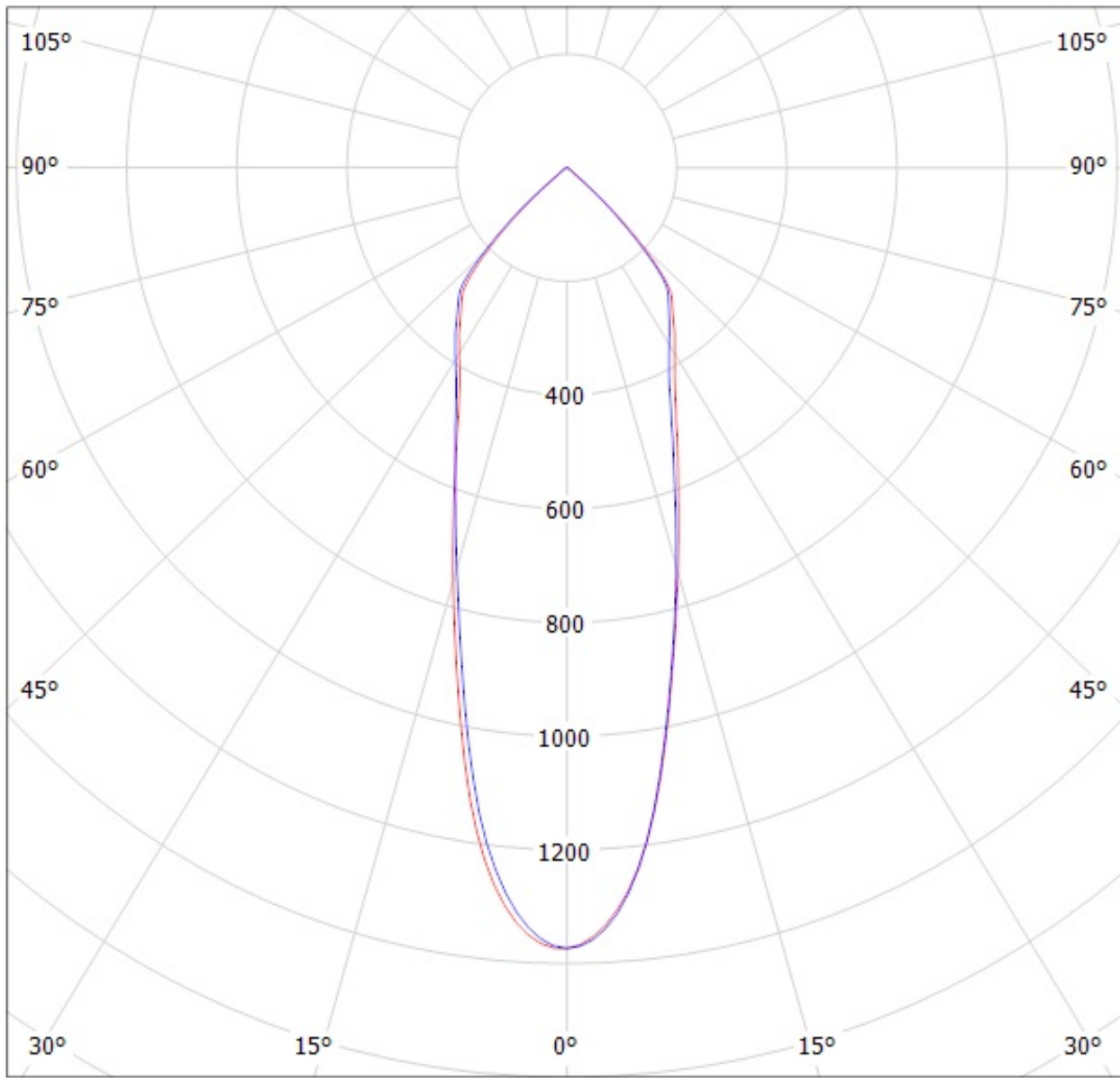

cd/klm

$\eta = 93\%$

— C0 - C180

— C90 - C270

Luminaire: LEDiL Oy F13401_ANGELINA-M_(CXA25) Eff.93.0%
Lamps: 1 x CREE_CXA25_(CXA2530-7C0-T2-N0H)_1151.98lm@250mA_CCT=3000K_P=8.4892W_I=249.8mA

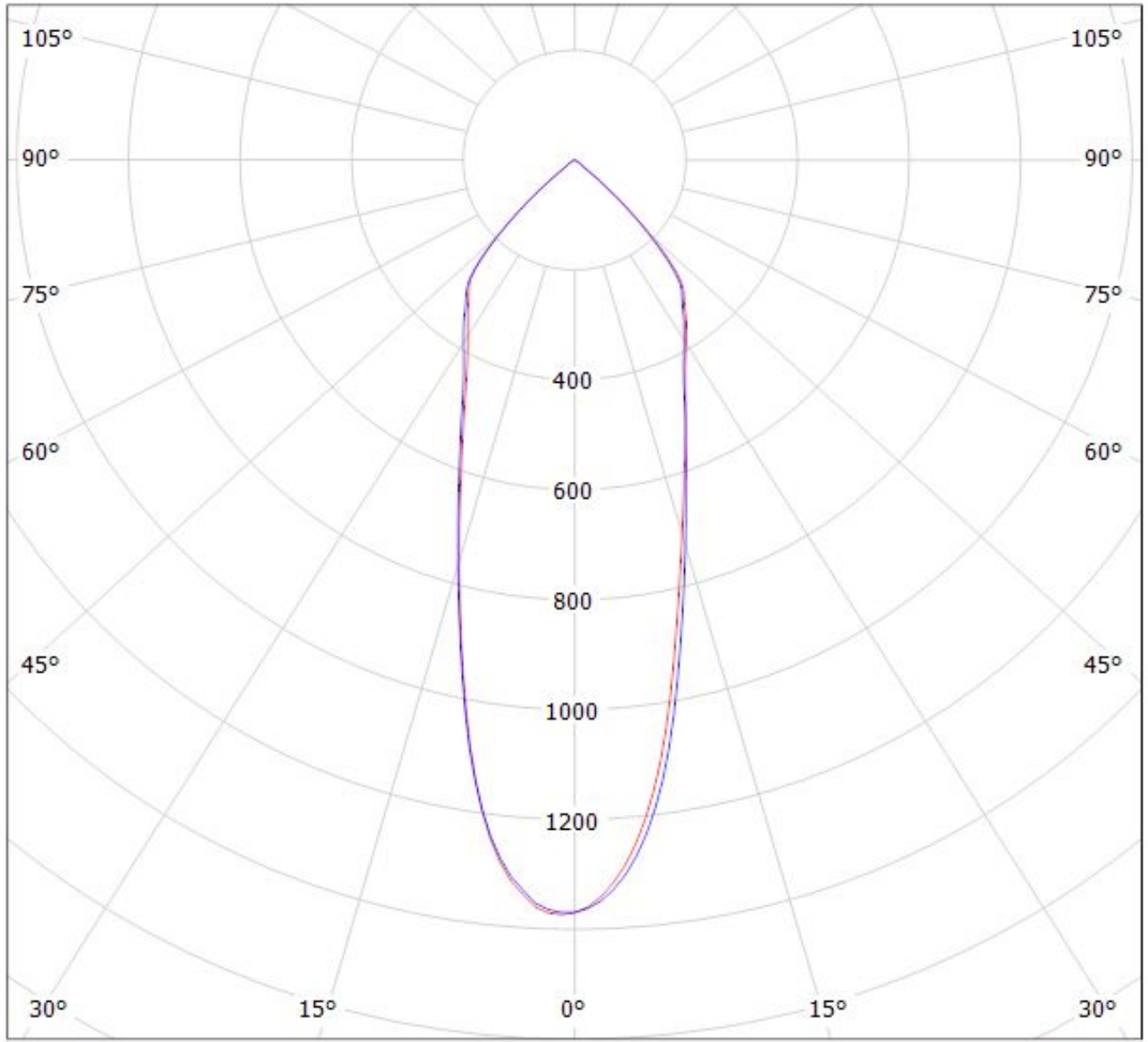

cd/klm

— C0 - C180 — C90 - C270

$\eta = 93\%$

Luminaire: LEDiL Oy F13401_ANGELINA-M_(FORTIMO_2000) Eff.90.5%

Lamps: 1 x PHILIPS Fortimo LED SLM 2000 23W/930 L19 G3 665.774lm@250mA CCT=3000K P=6W I=250mA

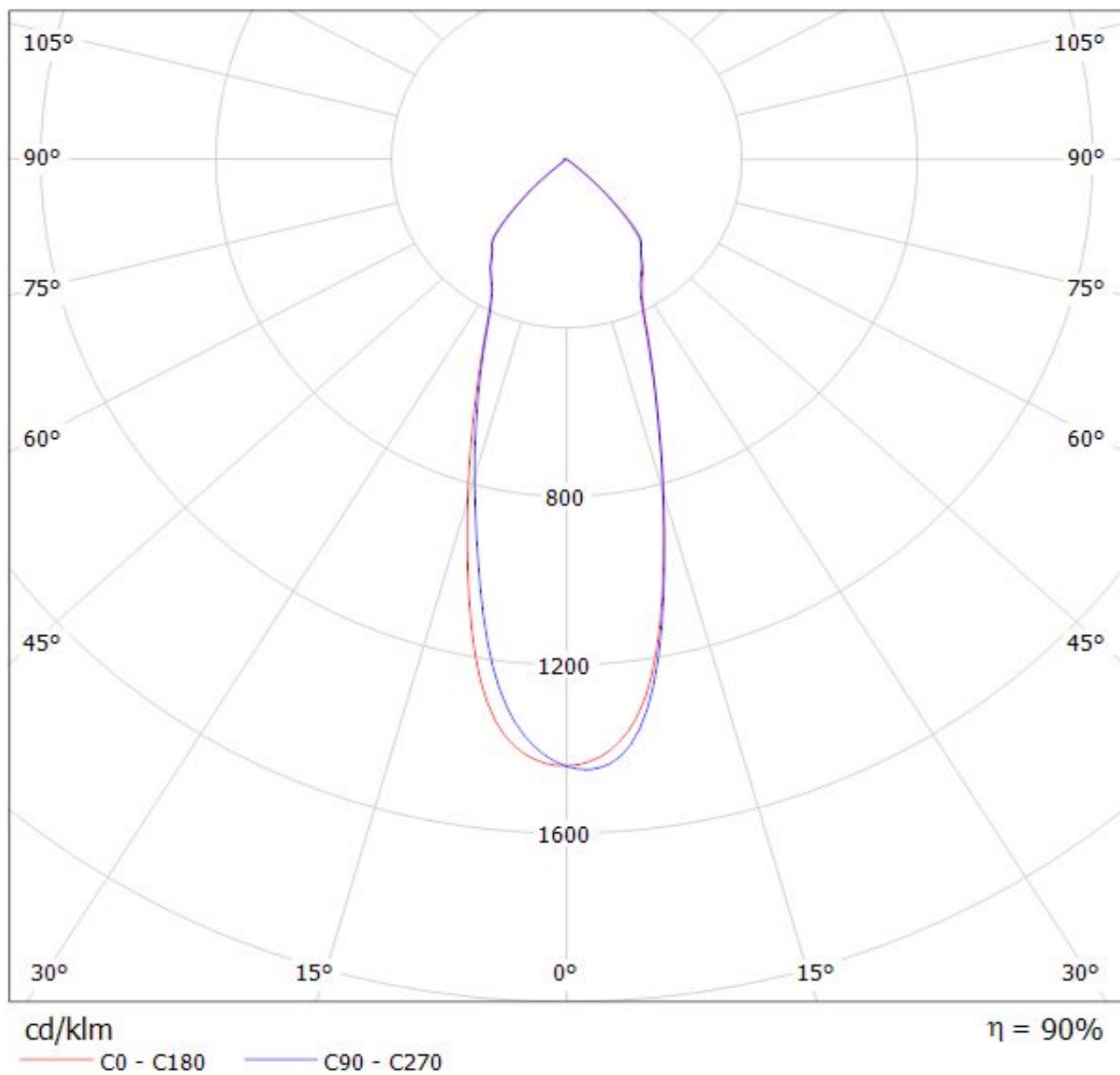

Luminaire: LEDiL Oy F13401_ANGELINA-M_(FORTIMO_3000) Eff.90.3%
Lamps: 1 x PHILIPS Fortimo LED SLM 3000 28W/830 L19 G3 1046.76lm@250mA CCT=3000K P=9W I=250mA

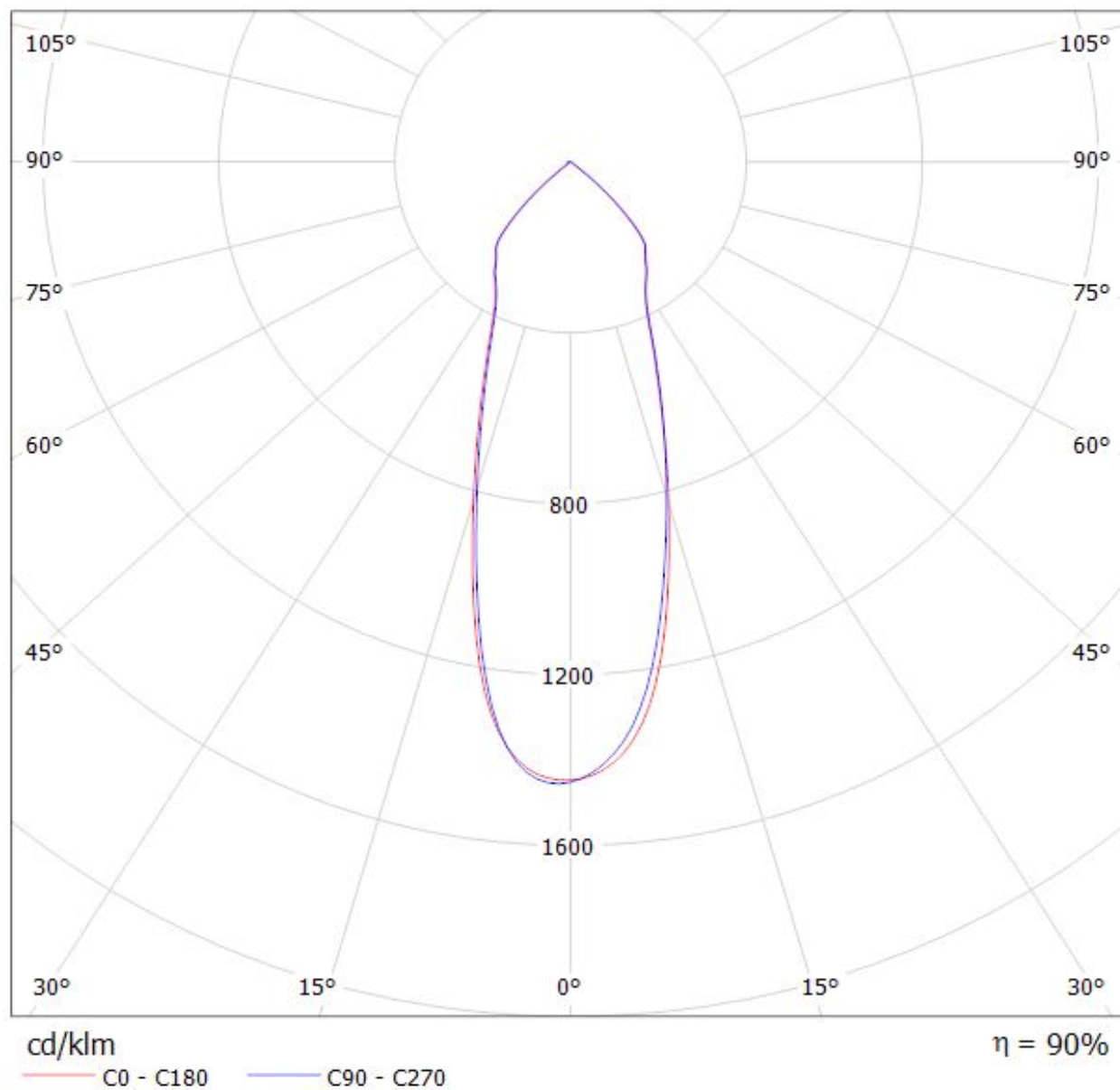

Luminaire: LEDiL F13401_ANGELINA-M_(CLL030)

Lamps: 1 x CLL030 740lm@250mA (CLL030-1205A5-303H1A7) CCT:3000K P:8.6W

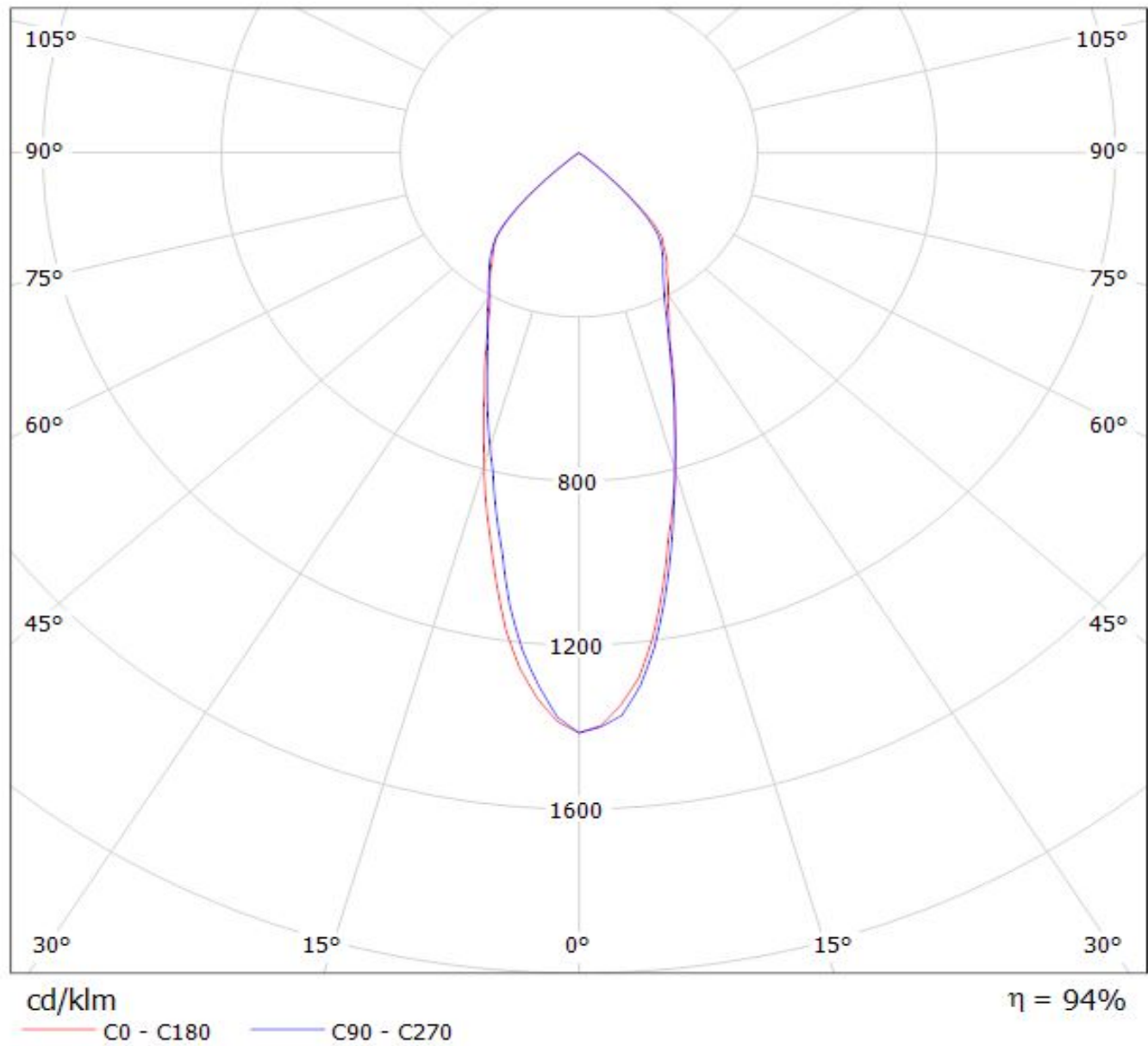

Luminaire: LEDiL Oy F13401_ANGELINA-M_(WU-M-461-827)

Lamps: 1 x Vossloh_WU-M-461-827_773.276lm@250mA_P=6.27423W_I=249.8mA

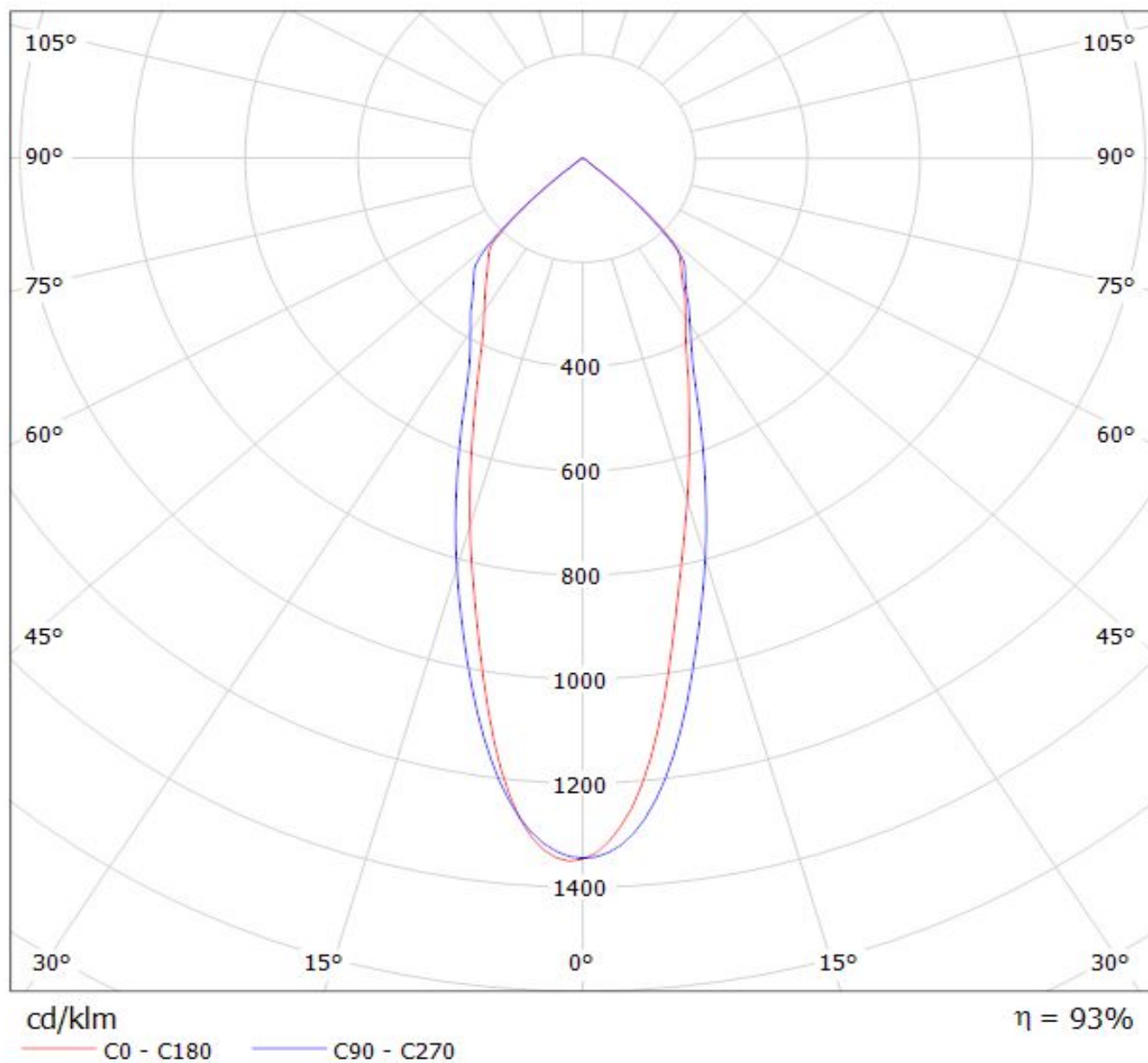

Luminaire: LEDiL Oy F13401_ANGELINA-M_(WU-M-484)

Lamps: 1 x Vossloh_Schwabe-WU-M-484_(WU-M-484-830)_657.125lm@250mA_P=5.59976W_I=249.9mA

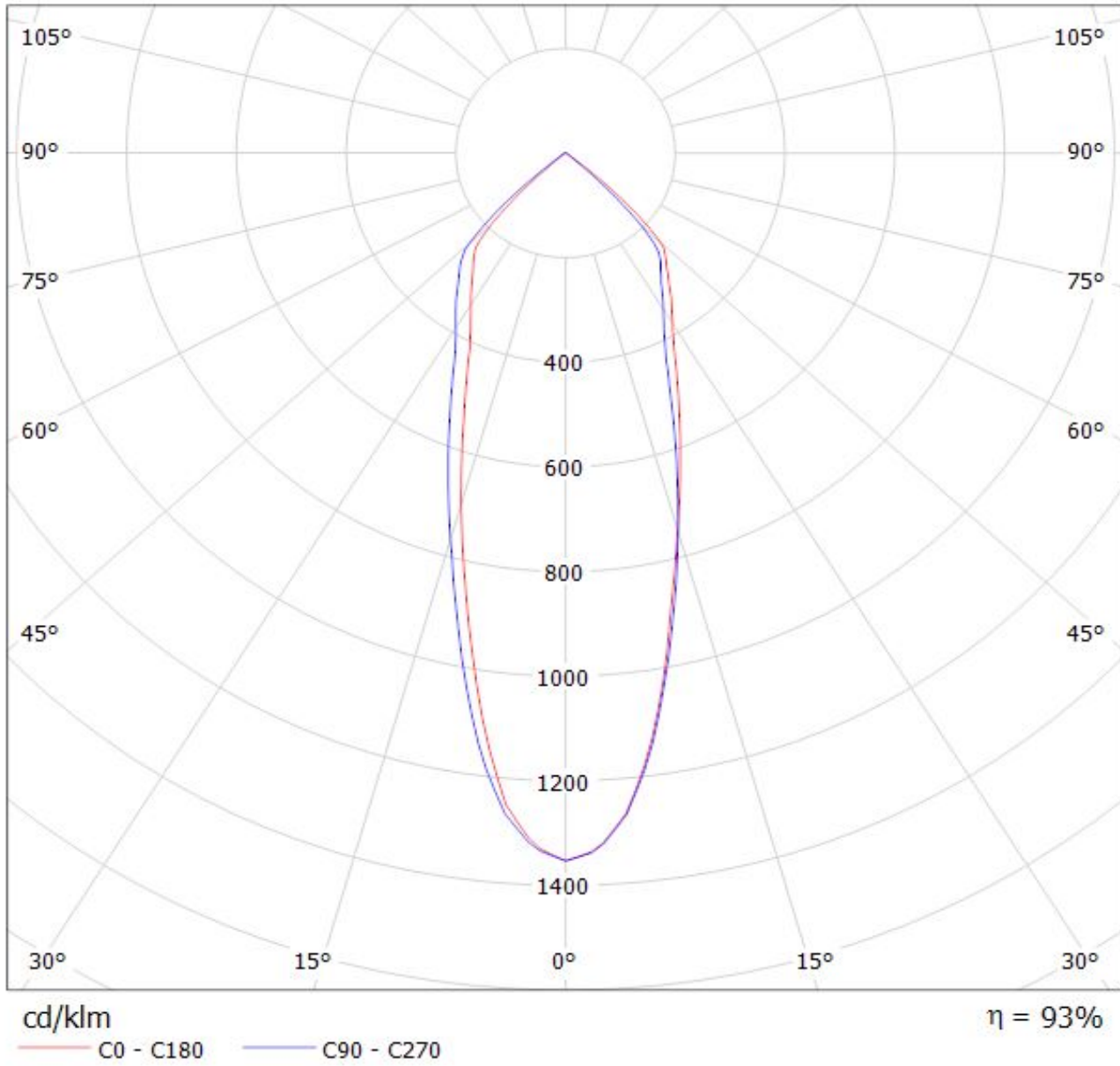

Luminaire: LEDiL Oy F13401_ANGELINA-M_(LEP-2000-827-C-AC)
Lamps: 1 x OSRAM PrevaLED Core AC (LEP-2000-827-C-AC)

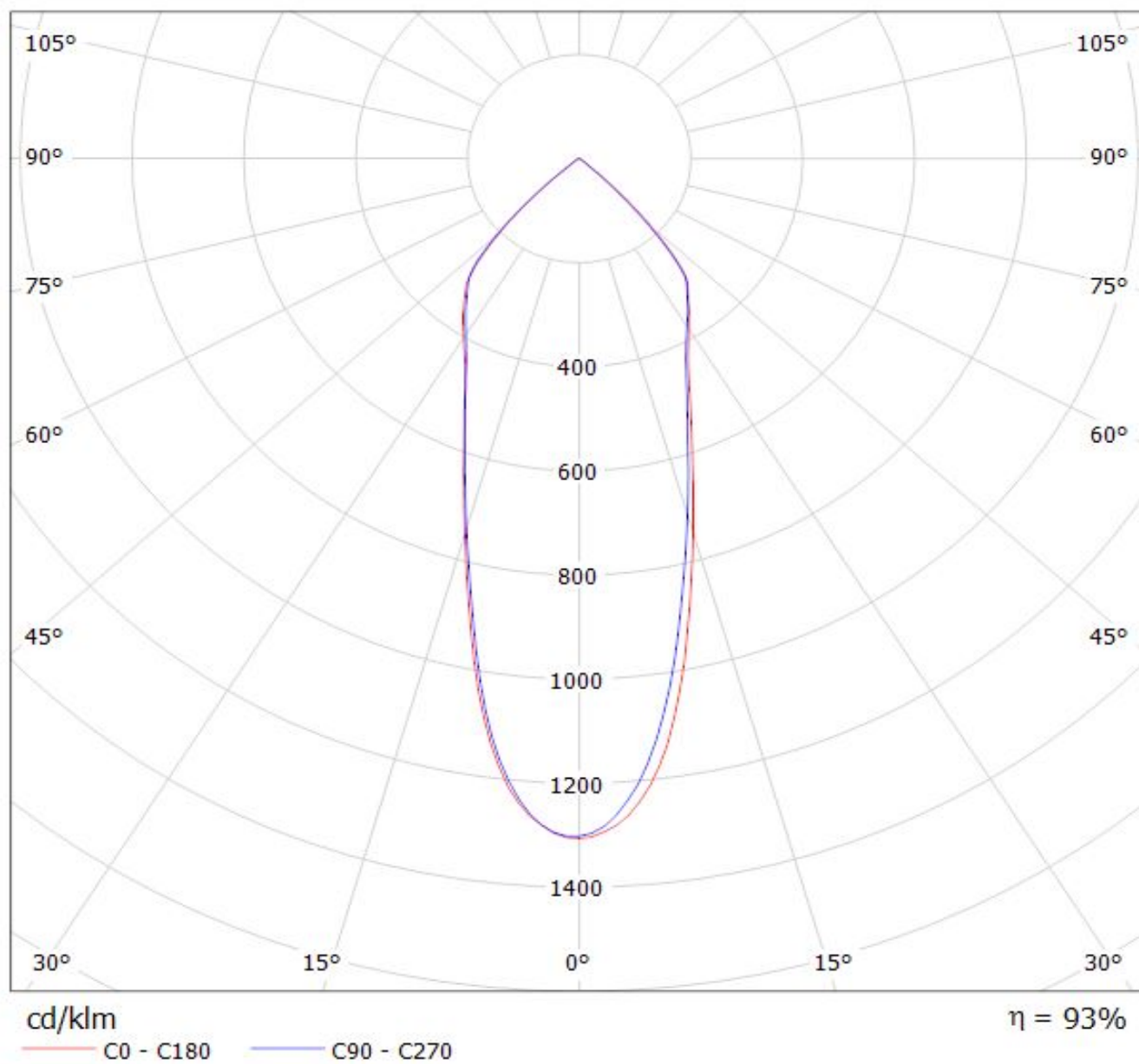

Luminaire: LEDiL Oy F13401_ANGELINA-M_(PrevaLED_LES19) Eff. 93%

Lamps: 1 x PrevaLED_LES19_(PL-CORE-2000-830-Z3)_1333.47lm@250mA_P=10.4584W_I=249.8mA

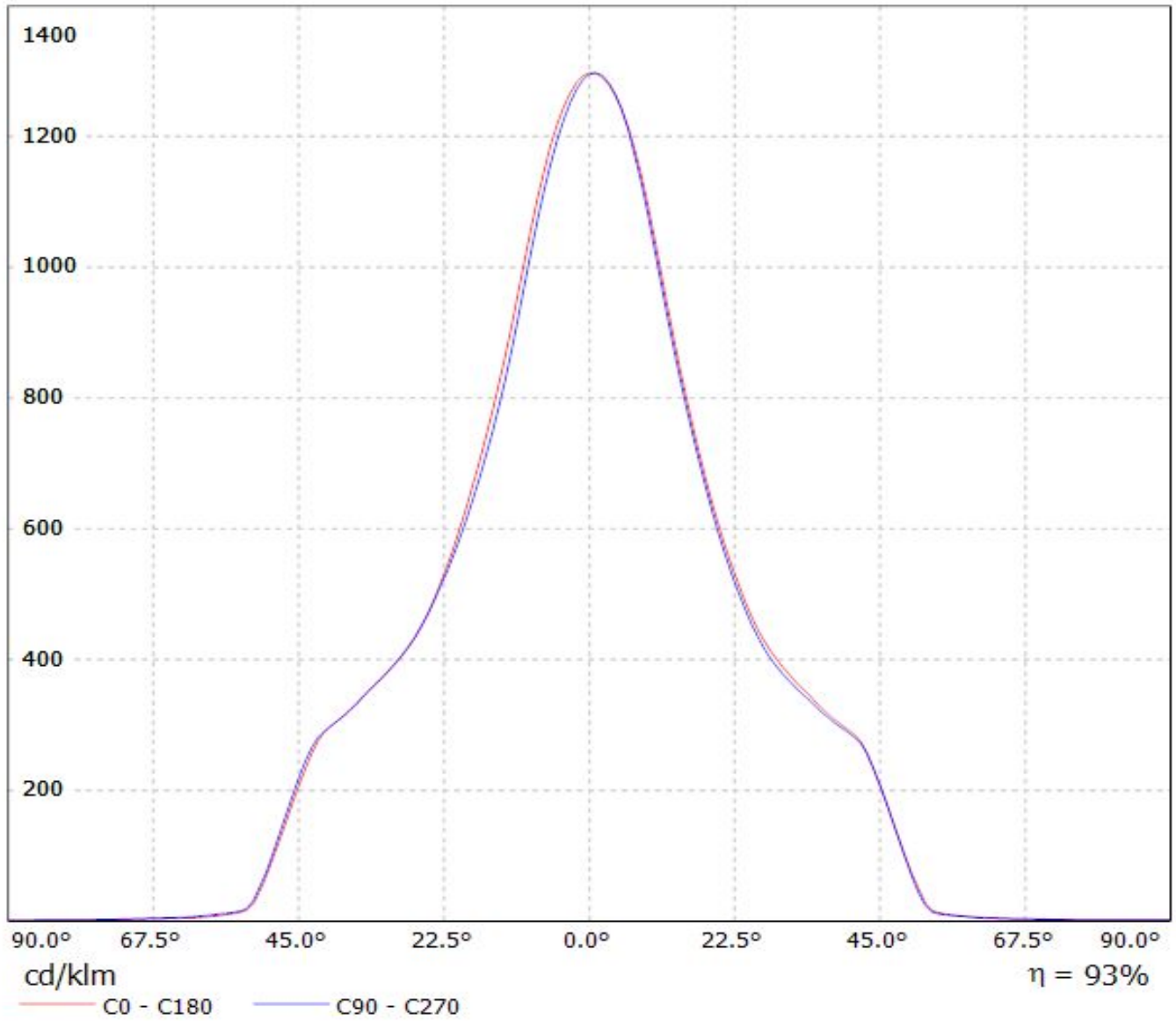

Luminaire: LEDiL Oy F13401_ANGELINA-M_(SOLERIQ_S19_&_TE_2213407-2)

Lamps: 1 x OSRAM_SOLERIQ_S19_(GW_KAHJB1.EM)_1393.62lm@250mA_CCT=3000K_P=10.5683W_I=249.8mA

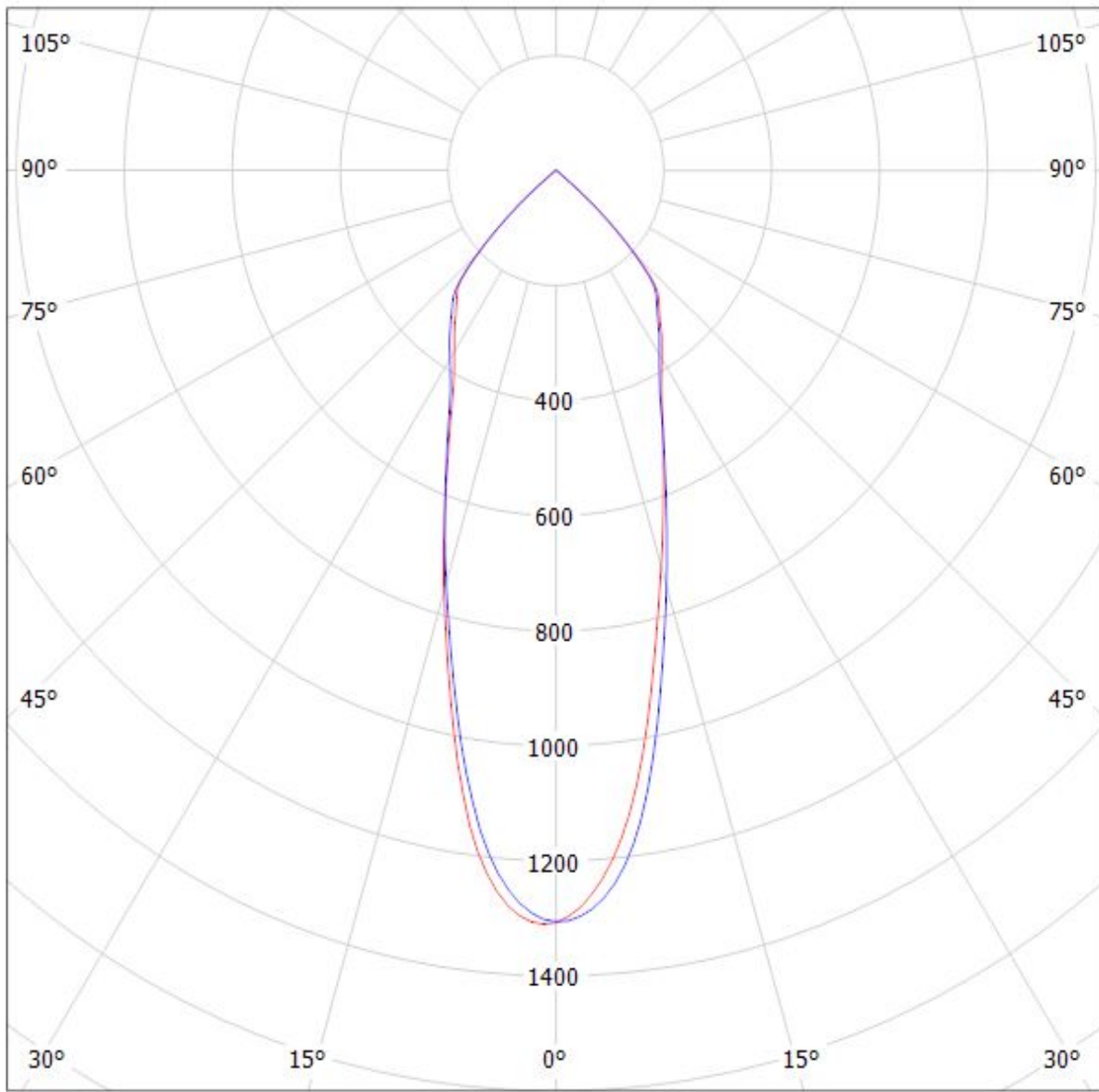

cd/klm

— C0 - C180 — C90 - C270

$\eta = 93\%$

Luminaire: LEDiL Oy F13401_ANGELINA-M_(NSBxL121A)

Lamps: 1 x Nichia_NSBxL121A_914.478lm@250mA_P=7.56872W_I=249.9mA

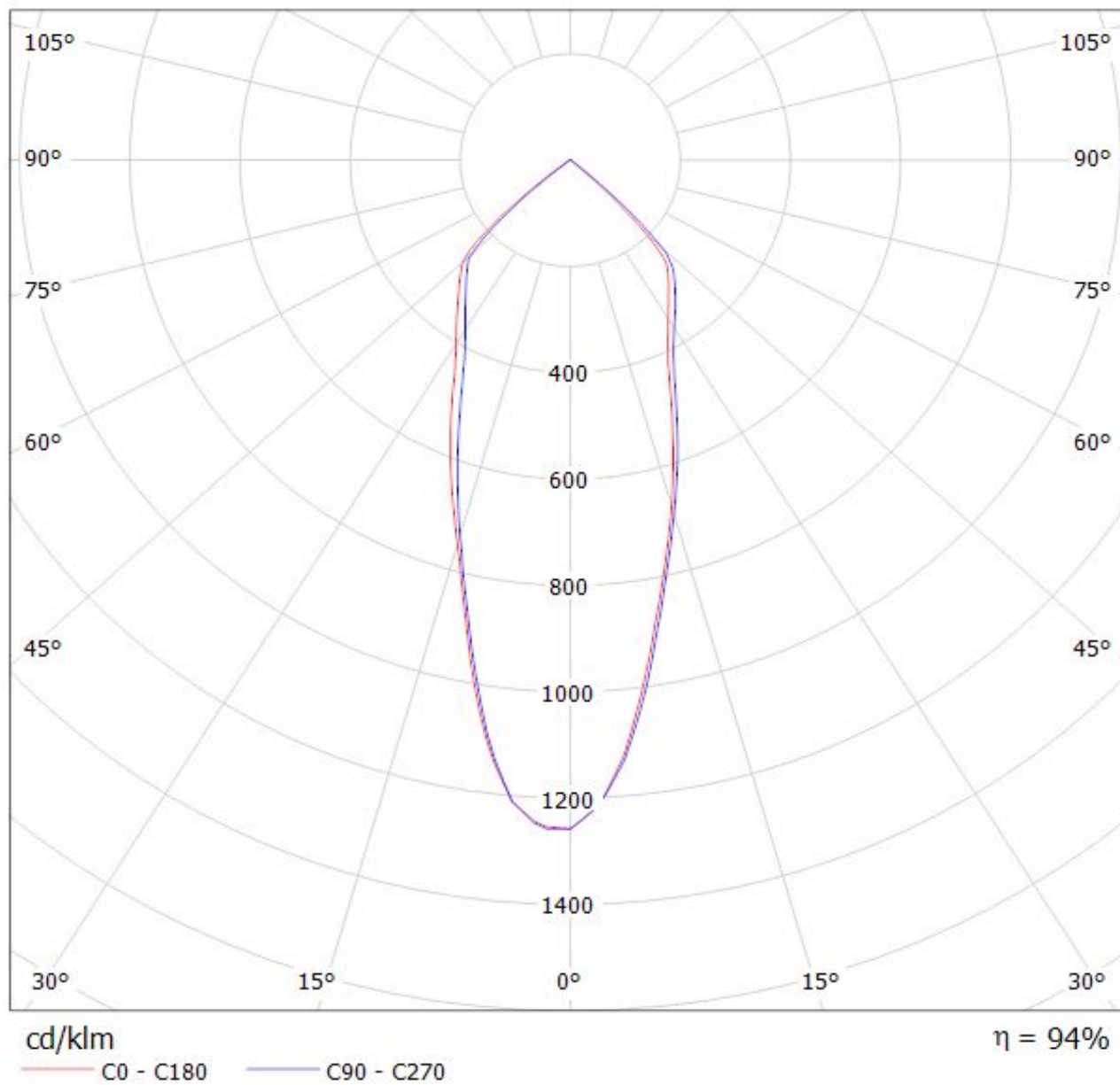

Luminaire: LEDiL Oy F13401_ANGELINA-M_(STARK_SLE_G2_LES23) Eff.90.2%

Lamps: 1 x TRIDONIC STARK SLE G2 LES23 830 CLA 982.731lm@250mA CCT=3000K P=8W I=250mA

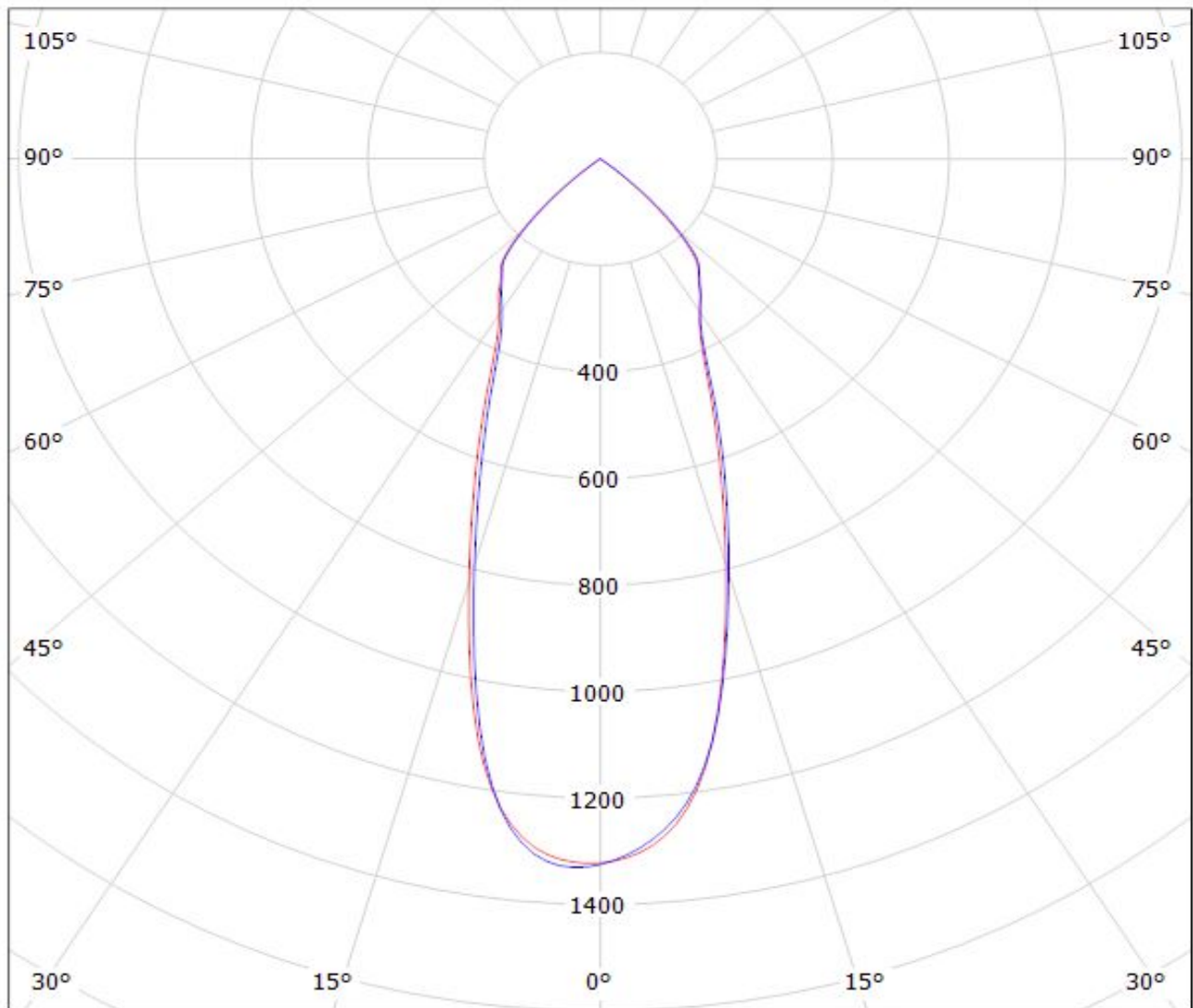

cd/klm

— C0 - C180

— C90 - C270

$\eta = 90\%$

Luminaire: LEDiL Oy F13401_ANGELINA-M_(SLE_G3_LES19) Eff.92.1%

Lamps: 1 x TRIDONIC_STARK_SLE_G3_LES19_(STARK-SLE-G3-LES19-2000-840-CLA)_1058.33lm@250mA_P=8.32833W_I=249.8mA

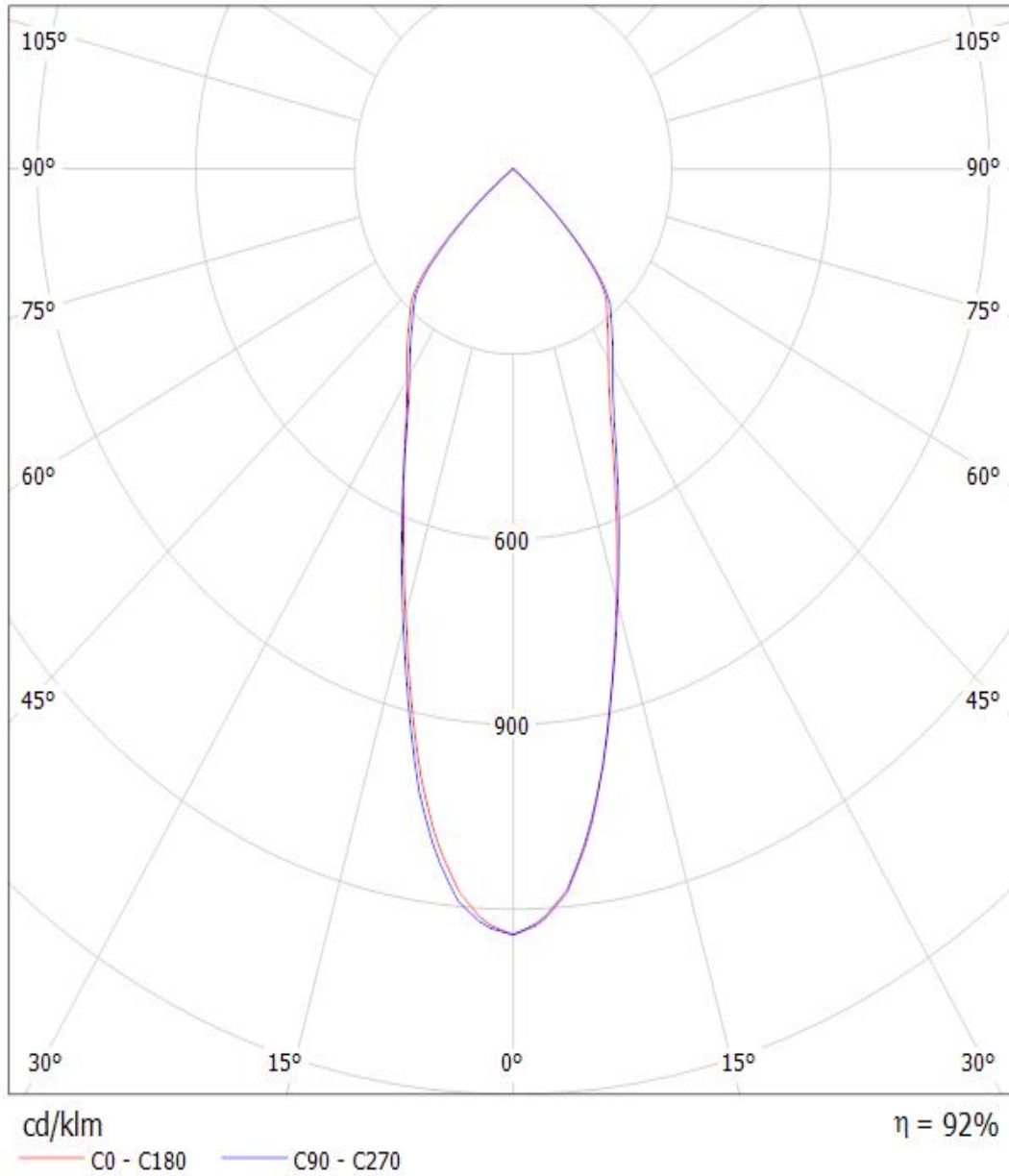

Luminaire: LEDiL Oy F13401_ANGELINA-M_(FORTIMO_3000) Eff.90.3%
Lamps: 1 x PHILIPS Fortimo LED SLM 3000 28W/830 L19 G3 1046.76lm@250mA CCT=3000K P=9W I=250mA

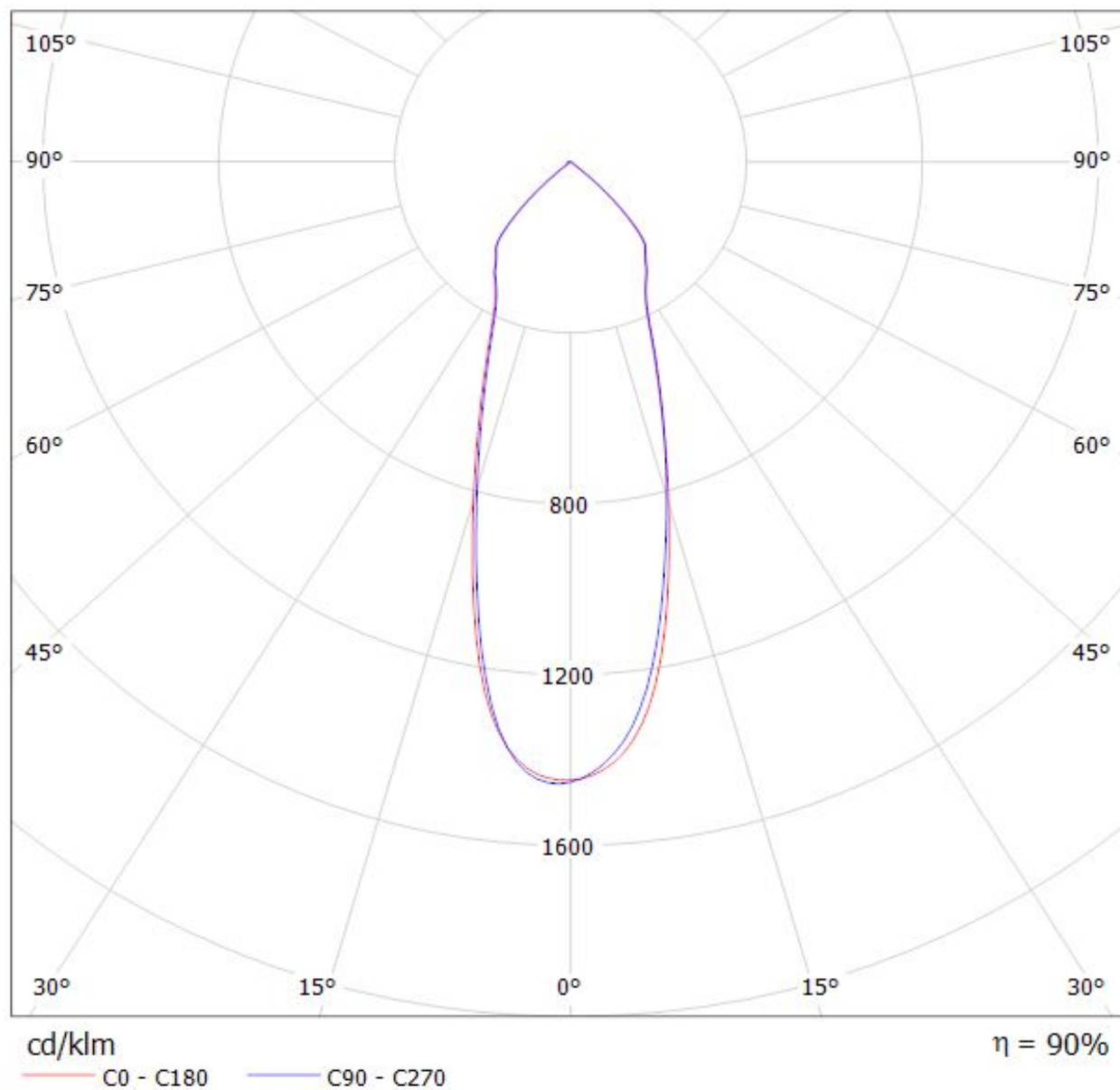

Luminaire: LEDiL Oy F13325_ANGELINA-S_(COB-LC026B) Eff.93.5%

Lamps: 1 x SAMSUNG_COB-LC026B_(SPHWWTHDNC25YHV52F)_1136.23lm@250mA_P=8.23191W_I=249.8mA

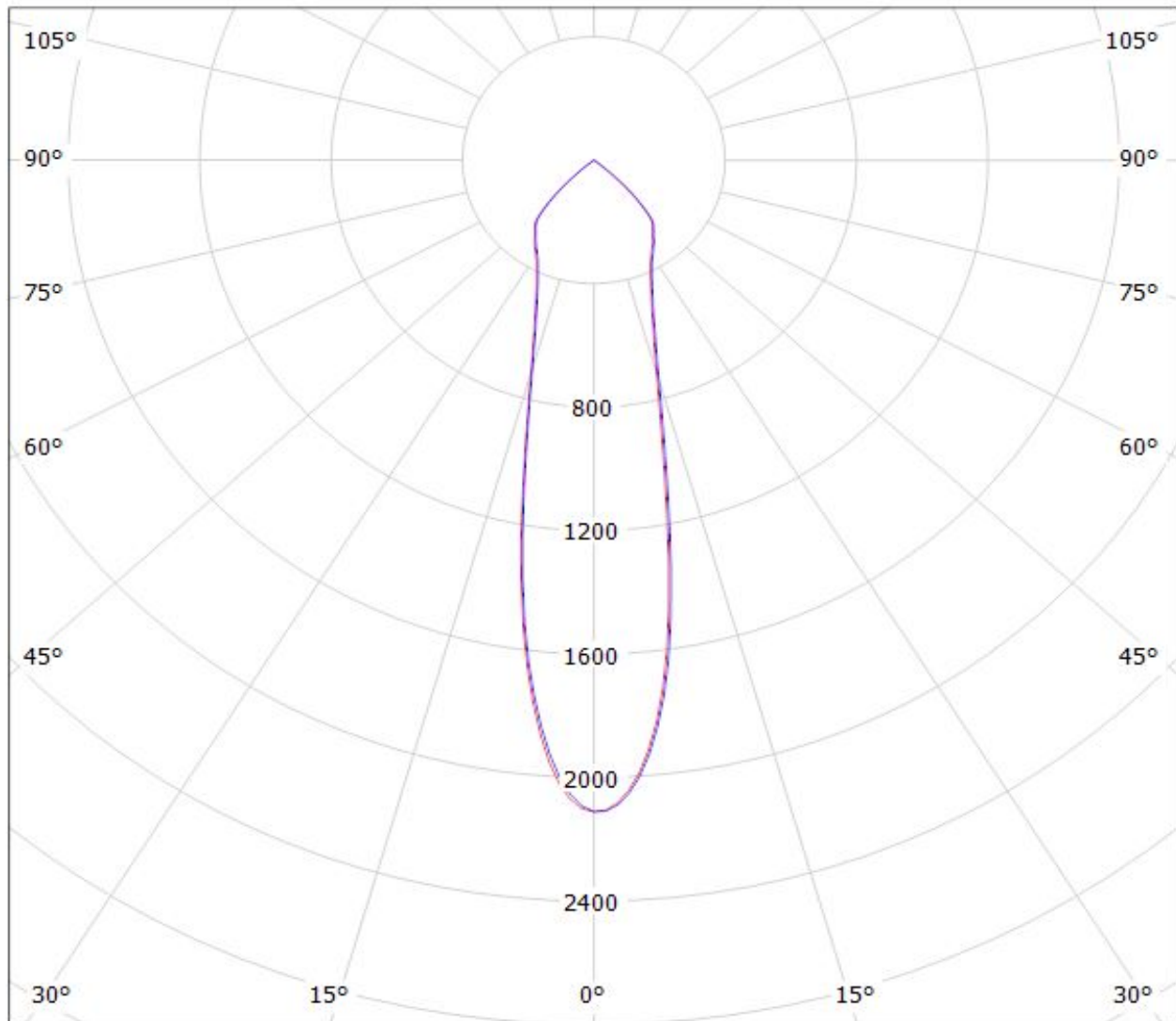

$\eta = 93\%$

cd/klm

— C0 - C180

— C90 - C270

Luminaire: LEDiL Oy F13401_ANGELINA-M_(CXA30) Eff. 93%

Lamps: 1 x CREE_CXA30_(CXA3050-3C0-Y2-N0H)_1340.66lm@250mA_P=8.16471W_CCT=5000K_I=249.8mA

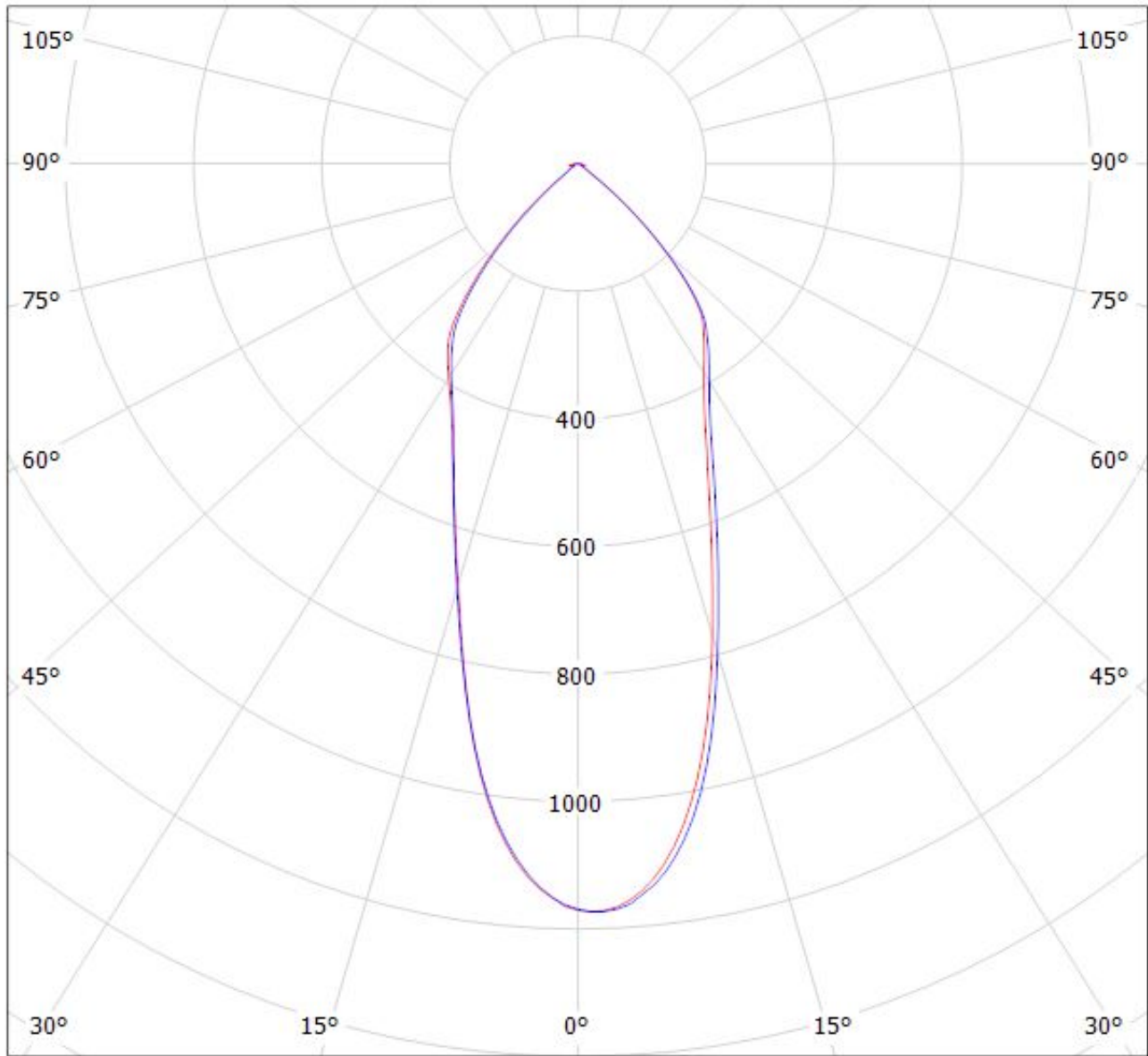

cd/klm

— C0 - C180

— C90 - C270

$\eta = 93\%$

Luminaire: LEDiL Oy F13401_ANGELINA-M_(STARK_SLE_G2_LES26) Eff.89.0%
Lamps: 1 x TRIDONIC STARK SLE G2 LES26 830 CLA 1095.88lm@250mA CCT=3000K P=8W I=250mA

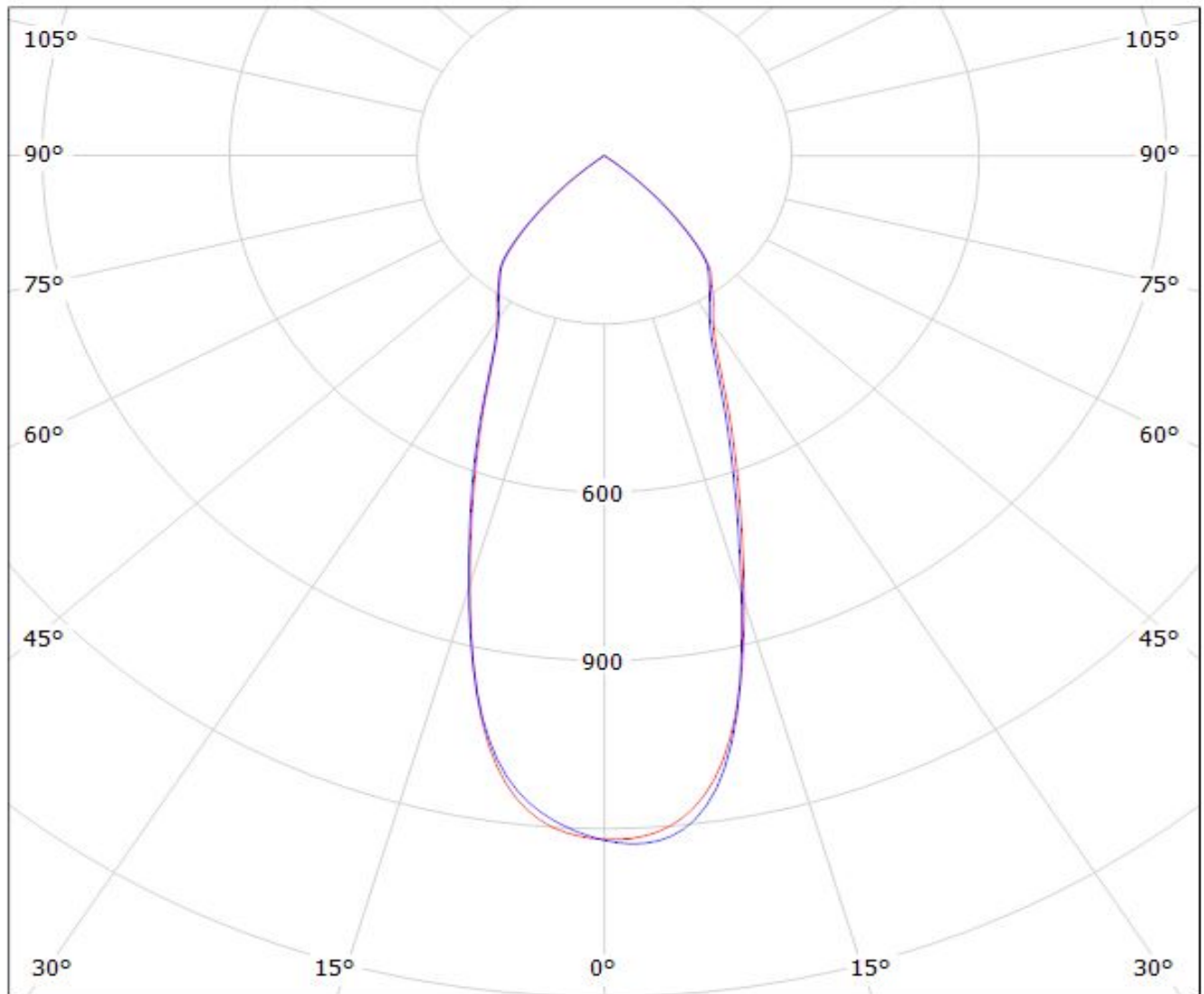

cd/klm

— C0 - C180 — C90 - C270

η = 89%

Luminaire: LEDiL Oy F13401_ANGELINA-M_(WU-M-486) Eff.92.1%
Lamps: 1 x Vossloh_Schwabe-WU-M-486_(WU-M-486-830)
_1474.55lm@250mA_P=10.4456W_I=249.8mA

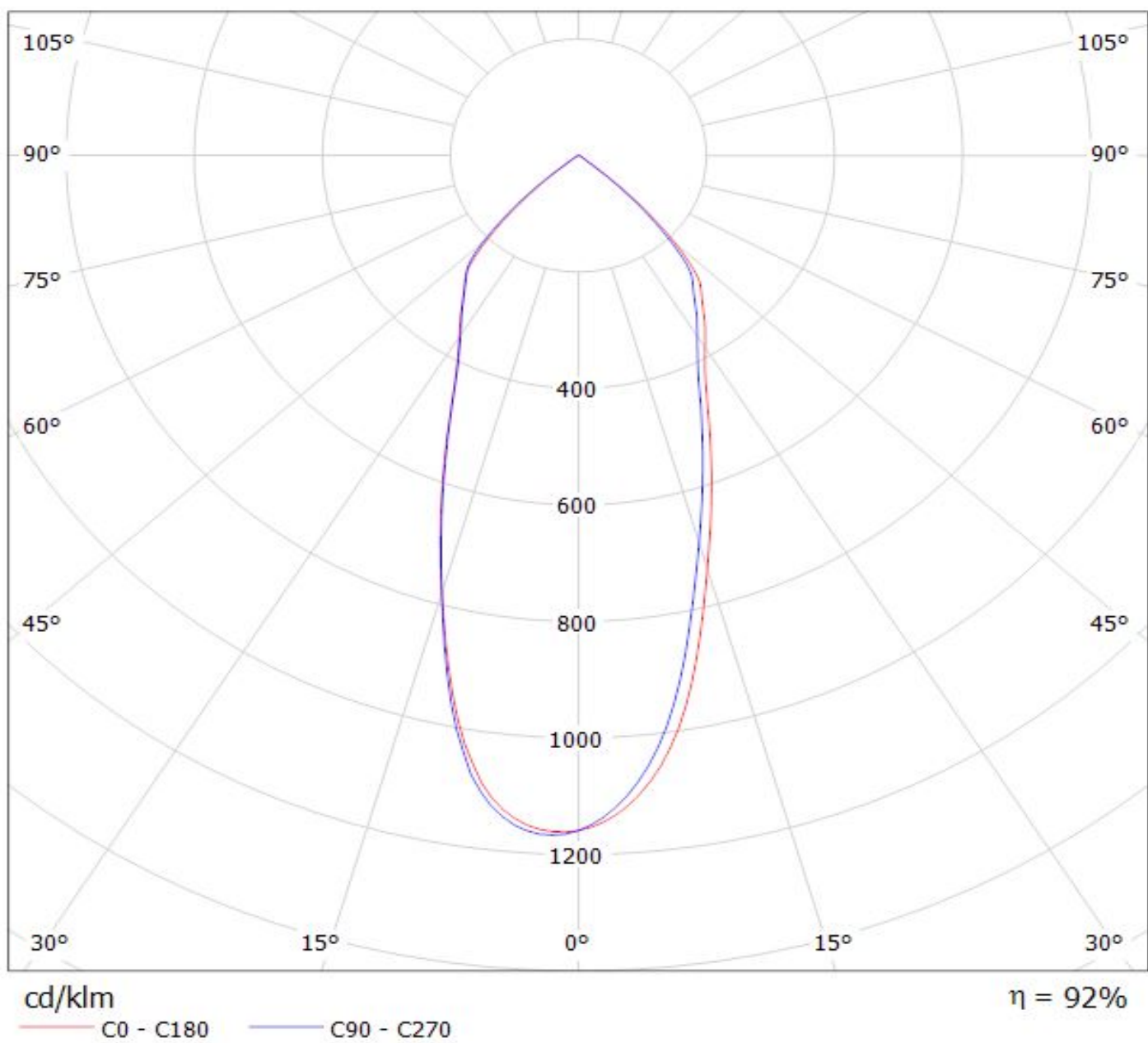

Luminaire: LEDiL Oy F13401_ANGELINA-M_(WU-M-462-827)

Lamps: 1 x Vossloh_WU-M-462-827_1116.7lm@250mA_P=8.9943W_I=249.8mA

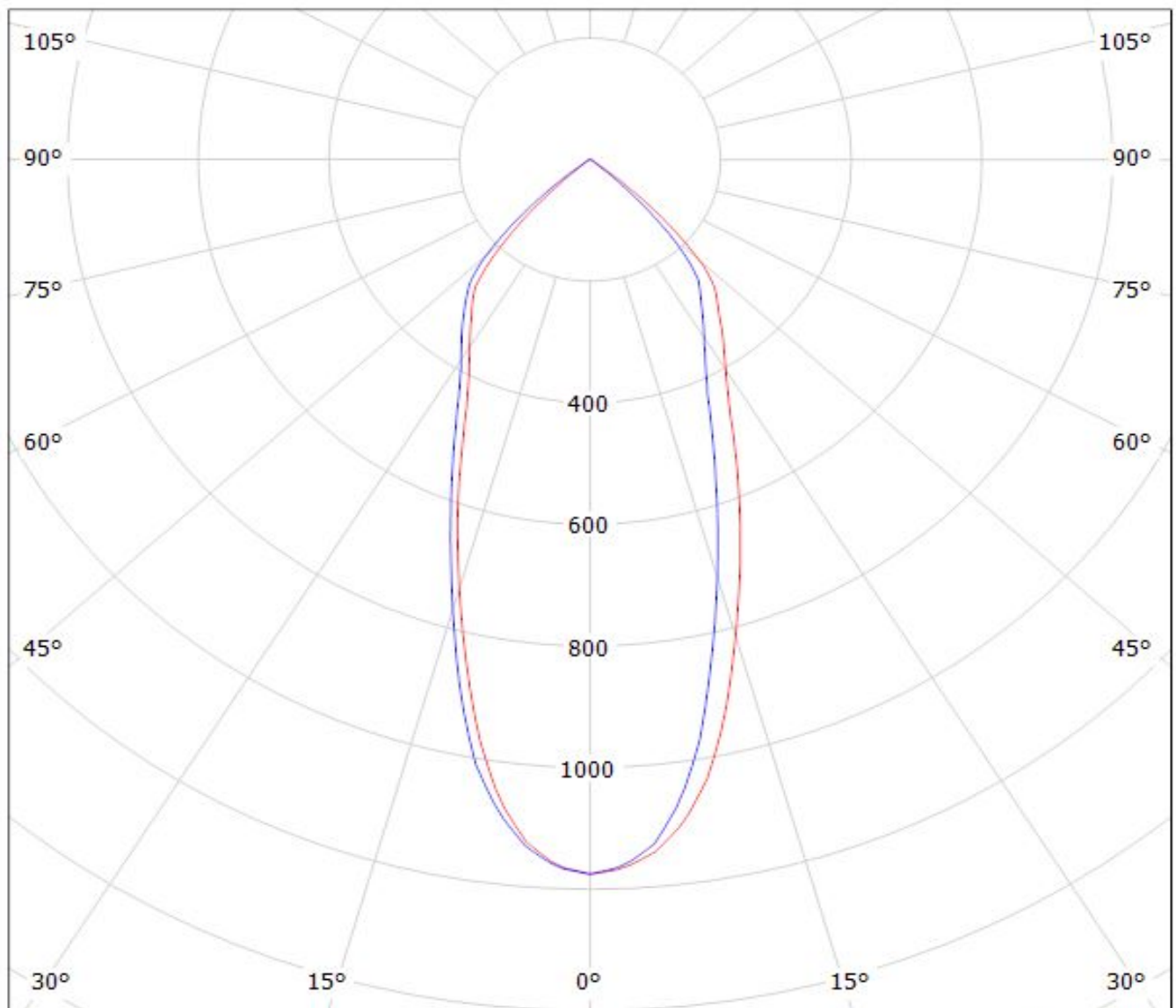

cd/klm

$\eta = 93\%$

— C0 - C180 — C90 - C270

Luminaire: LEDiL Oy F13401_ANGELINA-M_(WU-M-464-827)

Lamps: 1 x Vossloh_WU-M-464-827_1452.93lm@250mA_P=11.6939W_I=249.8mA

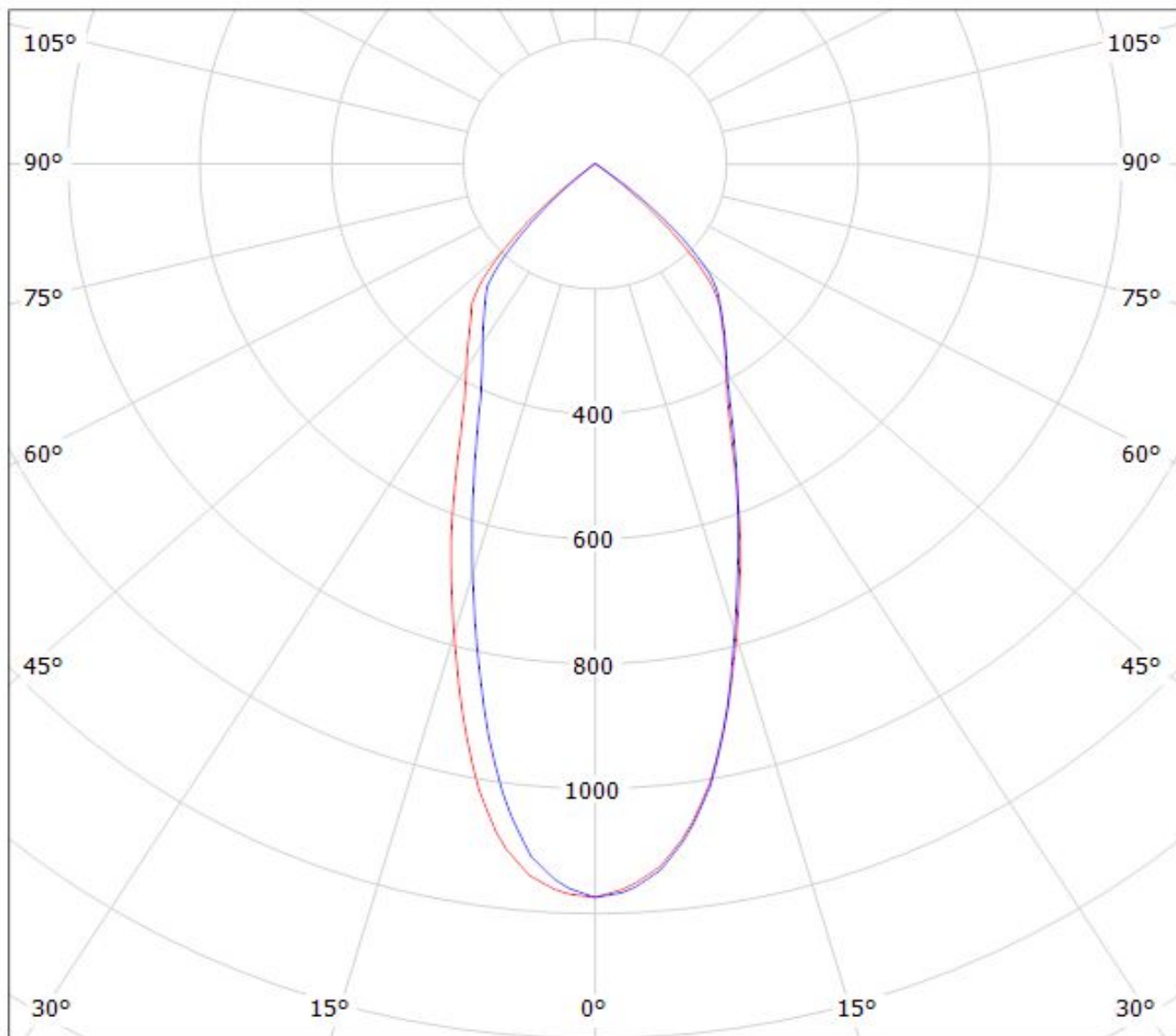

cd/klm

— C0 - C180

— C90 - C270

$\eta = 93\%$

Luminaire: LEDiL Oy F13401_ANGELINA-M_(PrevaLED_LES23) Eff.94%

Lamps: 1 x OSRAM PrevaLED_LES23_(PL-CORE-5000-930-Z3)_1102.2lm@250mA_P=9.93654W_I=249.8mA

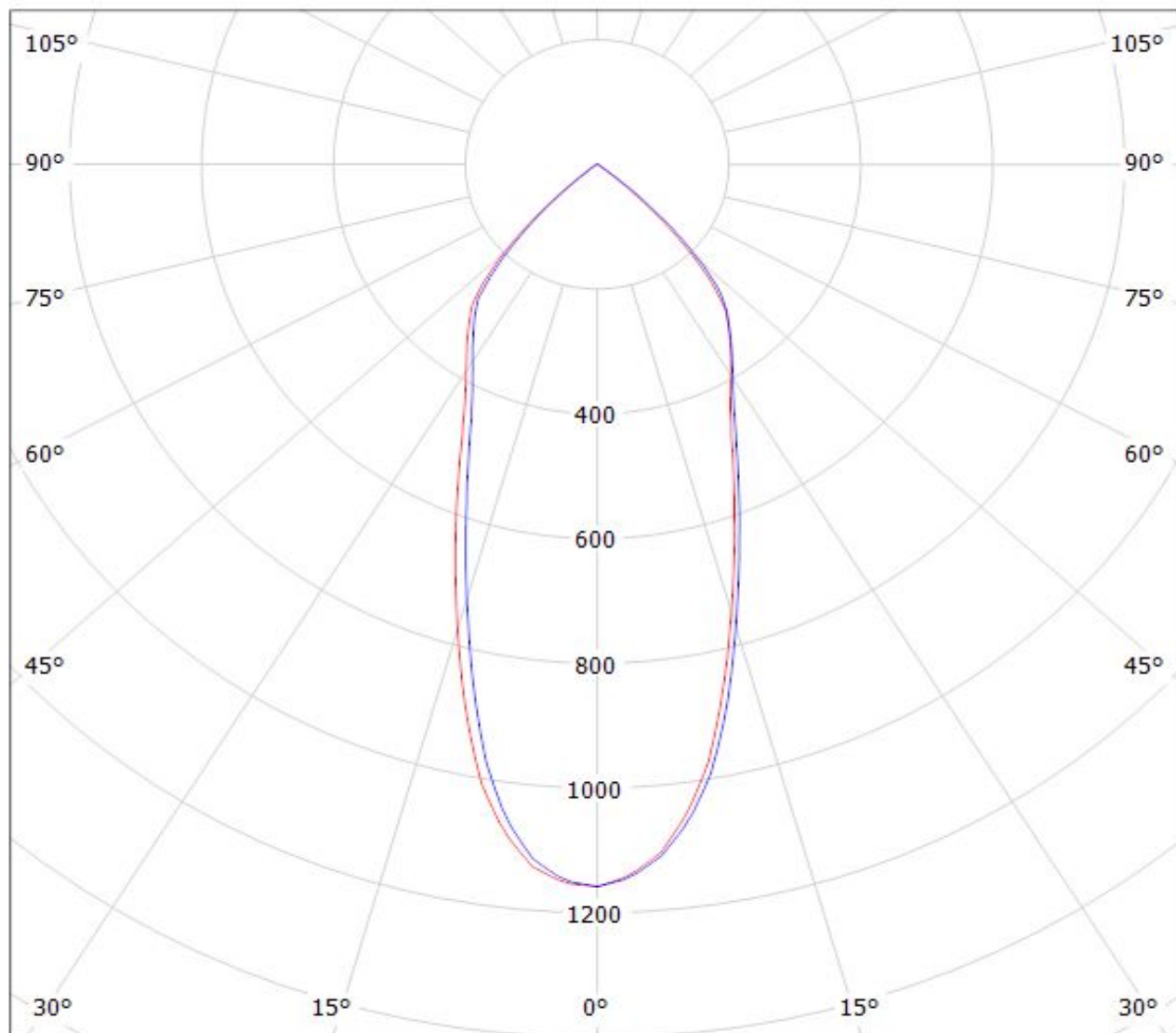

cd/klm

— C0 - C180

— C90 - C270

$\eta = 94\%$

Luminaire: LEDiL Oy F13401_ANGELINA-M_(WU-M-485)

Lamps: 1 x Vossloh_Schwabe-WU-M-485_(WU-M-485-830)_1209.62lm@250mA_P=8.43849W_I=249.8mA

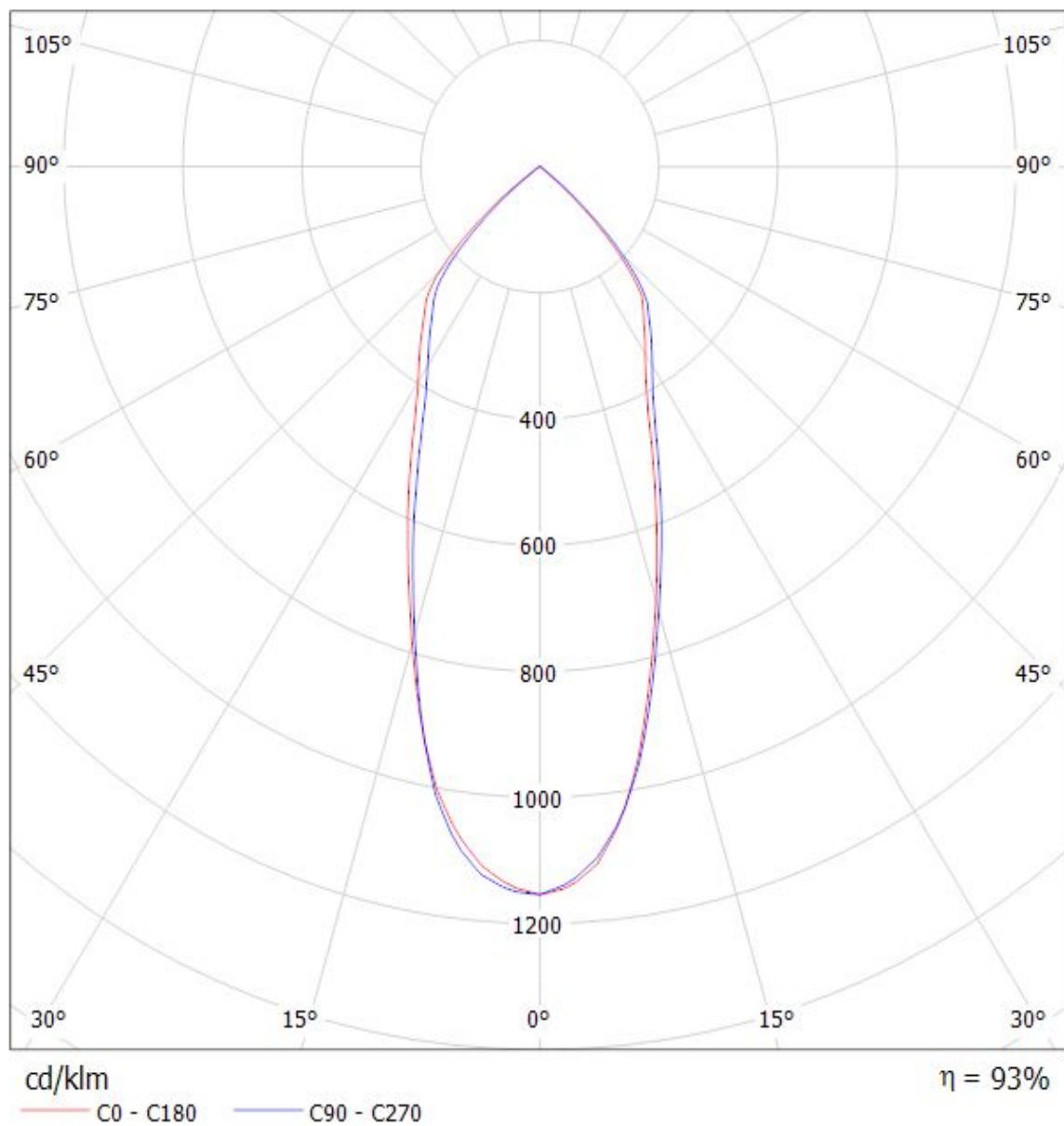

Luminaire: LEDiL Oy F13401_ANGELINA-M_(SLE_G3_LES23) Eff.90.0%

Lamps: 1 x TRIDONIC_STARK_SLE_G3_LES23_(STARK-SLE-PURE_G3-23-3000-930-SEL)_813.196lm@250mA_CCT=3000K_P=8.20018W_I=249.8mA

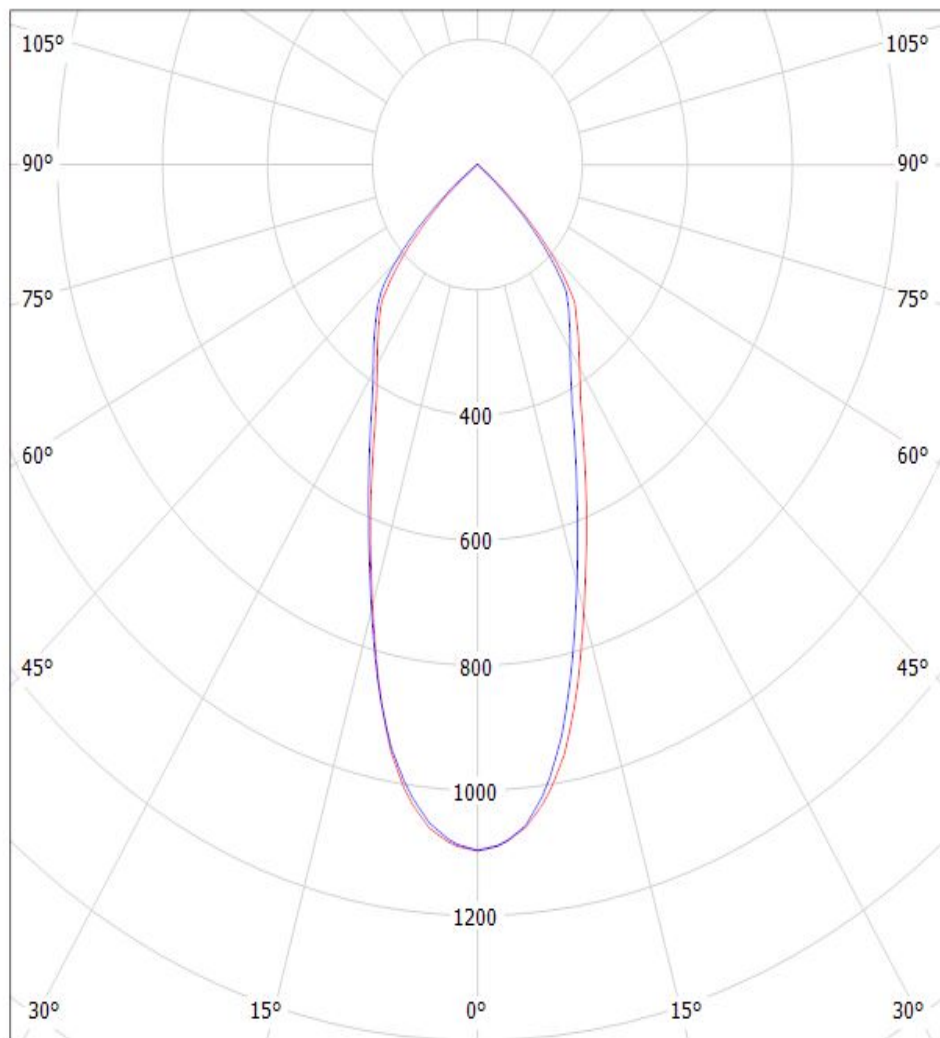

cd/klm

— C0 - C180

— C90 - C270

$\eta = 90\%$

Luminaire: LEDiL Oy F13401_ANGELINA-M_(CXA3590)

Lamps: 1 x CREE_CXA3590_(CXA3590-30F-BD-R0H-0002)_2640.14lm@250mA_CCT=3000K_P=16.3941W_I=249.8mA

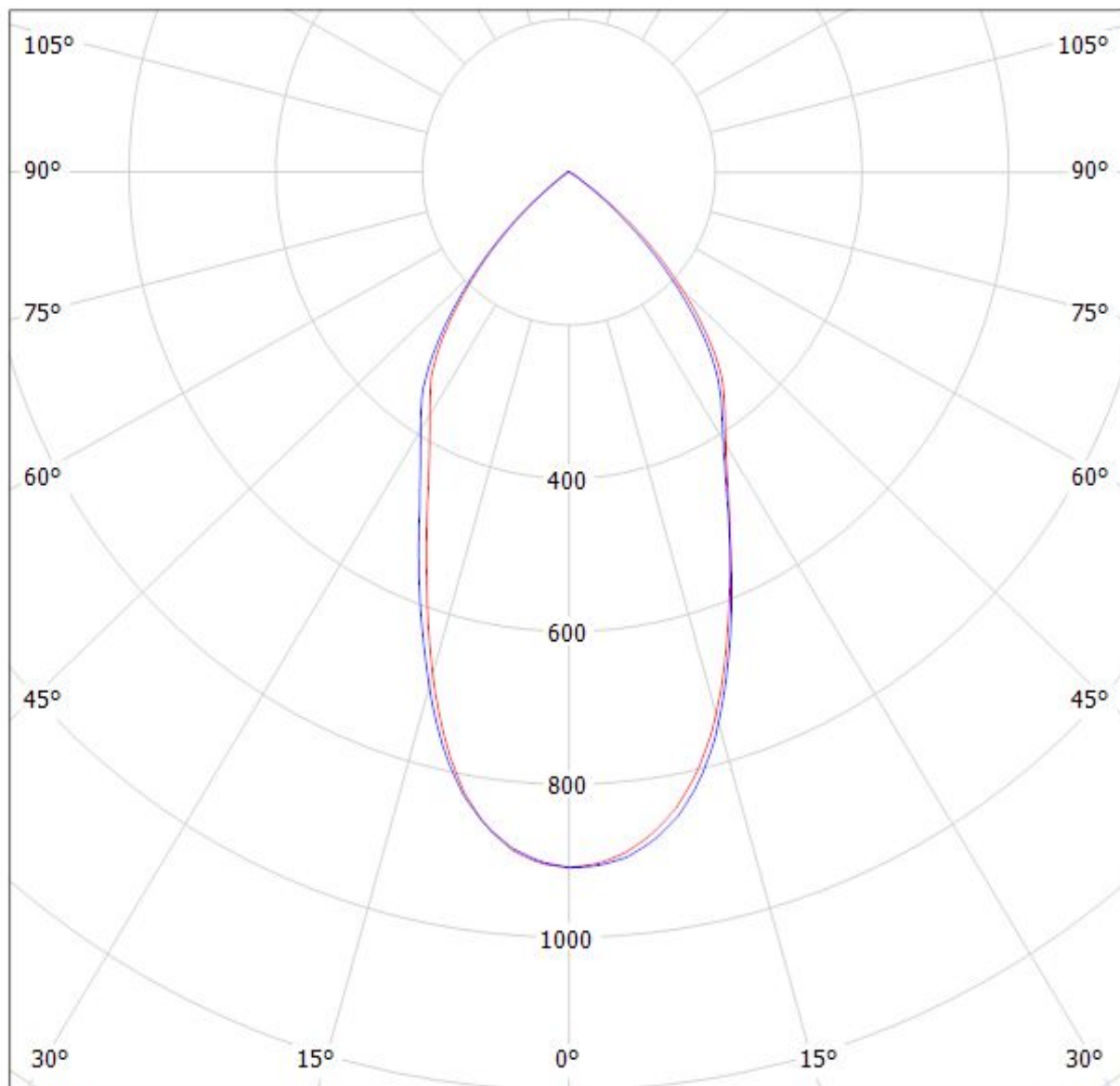

cd/klm

$\eta = 92\%$

— C0 - C180 — C90 - C270

NOTE: The typical divergence will be changed by different color, chip size and chip position tolerance. The typical total divergence is the full angle measured where the luminous intensity is half of the peak value.

GENERAL INFORMATION

- Product series especially designed & optimized for series of LEDs.
- Special care taken to make light distribution as uniform as possible.
- Reflector is made of aluminium coated PC (120 degrees of Celcius / 248 degrees of Fahrenheit) with protective lacquer (short term 100 degrees of Celcius / 212 degrees of Fahrenheit).

Note! Due to use of high power COB's with this product, special attention to proper thermal design is highly recommended. LEDiL has no liability for direct, indirect or consecutive damages arising from the LEDiL products being used outside of the recommended temperature range.