



Main

Range of product	Modicon M221
Product or component type	Logic controller
[Us] rated supply voltage	24 V DC
Discrete input number	9 discrete input conforming to IEC 61131-2 Type 1 including 4 fast input
Analogue input number	2 at input range: 0...10 V
Discrete output type	Transistor
Discrete output number	7 transistor including 2 fast output
Discrete output voltage	24 V DC
Discrete output current	0.5 A

Complementary

Discrete I/O number	16
Number of I/O expansion module	<= 4 with <= 28 discrete output(s) for relay output <= 4 with <= 136 discrete output(s) for transistor output
Supply voltage limits	19.2...28.8 V
Inrush current	<= 35 A
Power consumption in W	<= 10 W at 24 V
Discrete input logic	Sink or source (positive/negative)
Discrete input voltage	24 V
Discrete input voltage type	DC
Analogue input resolution	10 bits
LSB value	10 mV
Conversion time	1 ms per channel + 1 controller cycle time for analog input
Permitted overload on inputs	+/- 15 V DC for analog input permanent +/- 30 V DC for analog input with 5 min maximum
Voltage state1 guaranteed	>= 15 V for input
Current state 1 guaranteed	>= 2.5 mA for input
Voltage state 0 guaranteed	<= 5 V for input
Current state 0 guaranteed	<= 1 mA for input
Discrete input current	7 mA for input
Input impedance	100 kOhm for analog input 3.4 kOhm for discrete input
Response time	10 ms turn-off operation for output 10 ms turn-on operation for output 5 µs turn-off operation for fast input 5 µs turn-on operation for fast input 100 µs turn-off operation for input; I8...I15 terminal 100 µs turn-on operation for input; I8...I15 terminal 35 µs turn-off operation for input; I2...I5 terminal 35 µs turn-on operation for input; I2...I5 terminal
Configurable filtering time	12 ms for input 3 ms for input 0 ms for input
Discrete output logic	Positive logic (source)
Output frequency	100 kHz for fast output (PWM/PLS mode) at Q0...Q1 terminal 0.1 kHz at Q2...Q6 terminal
Absolute accuracy error	+/- 1 % of full scale for analog input
Leakage current	0.1 mA for transistor output
Voltage drop	<= 1 V

Mechanical durability	>= 20000000 cycles for transistor output
Tungsten load	<= 12 W for output and fast output
Protection type	Overload and short-circuit protection at 1.3 A
Reset time	1 s automatic reset
Memory capacity	256 kB for program with 10000 instructions
Data backed up	256 kB built-in flash memory for backup of programs
Data storage equipment	2 GB SD card optional
Battery type	BR2032 lithium non-rechargeable, battery life: 4 yr
Backup time	1 year at 25 °C by interruption of power supply
Execution time for 1 KInstruction	0.3 ms for event and periodic task
Execution time per instruction	0.2 µs Boolean
Exct time for event task	60 µs response time
Clock drift	<= 30 s/month at 25 °C
Regulation loop	Adjustable PID regulator up to 14 simultaneous loops
Positioning functions	PWM/PLS function 2 channel(s) (positioning frequency: 100 kHz)
Control signal type	Single phase signal at 100 kHz for fast input (HSC mode) Pulse/Direction signal at 100 kHz for fast input (HSC mode) A/B signal at 50 kHz for fast input (HSC mode)
Counting input number	4 fast input (HSC mode) (counting frequency: 100 kHz), counting capacity: 32 bits
Integrated connection type	Non isolated serial link "serial 2" with connector RJ45 and interface RS232/RS485 Non isolated serial link "serial 1" with connector RJ45 and interface RS485 USB port with connector mini B USB 2.0
Supply	Serial serial link supply at 5 V 200 mA
Transmission rate	480 Mbit/s - communication protocol: USB 1.2...115.2 kbit/s (115.2 kbit/s by default) for bus length of 3 m - communication protocol: RS232 1.2...115.2 kbit/s (115.2 kbit/s by default) for bus length of 15 m - communication protocol: RS485
Communication port protocol	Non isolated serial link : Modbus protocol master/slave - RTU/ASCII or SoMachine-Network USB port : USB protocol - SoMachine-Network
Local signalling	1 LED per channel green for I/O state 1 LED green for SL2 1 LED green for SL1 1 LED red for BAT 1 LED green for SD card access (SD) 1 LED red for module error (ERR) 1 LED green for RUN 1 LED green for PWR
Electrical connection	Mini B USB 2.0 connector for a programming terminal Connector, 4 terminal(s) for analogue inputs Terminal block, 3 terminal(s) for connecting the 24 V DC power supply Removable screw terminal block for outputs Removable screw terminal block for inputs
Cable length	<= 3 m shielded cable for fast output <= 30 m unshielded cable for output <= 10 m shielded cable for fast input <= 30 m unshielded cable for input
Insulation	Non-insulated between analogue inputs Non-insulated between analogue input and internal logic 500 V AC between output and internal logic Non-insulated between inputs 500 V AC between fast input and internal logic 500 V AC between input and internal logic
Marking	CE
Mounting support	Plate or panel with fixing kit Top hat type TH35-7.5 rail conforming to IEC 60715 Top hat type TH35-15 rail conforming to IEC 60715
Height	70 mm
Depth	70 mm
Width	95 mm
Product weight	0.346 kg

Environment

Standards	EN/IEC 61131-2 EN/IEC 61010-2-201
Product certifications	CSA CULus IACS E10 RCM
Resistance to electrostatic discharge	4 kV on contact conforming to EN/IEC 61000-4-2 8 kV in air conforming to EN/IEC 61000-4-2
Resistance to electromagnetic fields	1 V/m (2 GHz...3 GHz) conforming to EN/IEC 61000-4-3 3 V/m (1.4 GHz...2 GHz) conforming to EN/IEC 61000-4-3 10 V/m (80 MHz...1 GHz) conforming to EN/IEC 61000-4-3
Resistance to magnetic fields	30 A/m at 50...60 Hz conforming to EN/IEC 61000-4-8
Resistance to fast transients	1 kV for serial link conforming to EN/IEC 61000-4-4 1 kV for Ethernet line conforming to EN/IEC 61000-4-4 1 kV for I/O conforming to EN/IEC 61000-4-4 2 kV for relay output conforming to EN/IEC 61000-4-4 2 kV for power lines conforming to EN/IEC 61000-4-4
Surge withstand	1 kV for relay output in differential mode conforming to EN/IEC 61000-4-5 1 kV for power lines (AC) in differential mode conforming to EN/IEC 61000-4-5 0.5 kV for power lines (DC) in differential mode conforming to EN/IEC 61000-4-5 1 kV for shielded cable in common mode conforming to EN/IEC 61000-4-5 1 kV for I/O in common mode conforming to EN/IEC 61000-4-5 2 kV for relay output in common mode conforming to EN/IEC 61000-4-5 2 kV for power lines (AC) in common mode conforming to EN/IEC 61000-4-5 1 kV for power lines (DC) in common mode conforming to EN/IEC 61000-4-5
Resistance to conducted disturbances, induced by radio frequency fields	10 Vrms (spot frequency (2, 3, 4, 6.2, 8.2, 12.6, 16.5, 18.8, 22, 25 MHz)) conforming to Marine specification (LR, ABS, DNV, GL) 3 Vrms (0.1...80 MHz) conforming to Marine specification (LR, ABS, DNV, GL) 10 Vrms (0.15...80 MHz) conforming to EN/IEC 61000-4-6
Electromagnetic emission	Radiated emissions conforming to EN/IEC 55011 class A 10 m, 230 MHz...1 GHz : 47 dB μ V/m QP Radiated emissions conforming to EN/IEC 55011 class A 10 m, 30...230 MHz : 40 dB μ V/m QP Conducted emissions conforming to EN/IEC 55011 power lines, 1.5...30 MHz : 63 dB μ V/m QP Conducted emissions conforming to EN/IEC 55011 power lines, 150 kHz...1.5 MHz : 79...63 dB μ V/m QP Conducted emissions conforming to EN/IEC 55011 power lines, 10...150 kHz : 120...69 dB μ V/m QP Conducted emissions conforming to EN/IEC 55011 power lines (AC), 0.5...300 MHz : 73 dB μ V/m QP/60 dB μ V/m AV Conducted emissions conforming to EN/IEC 55011 power lines (AC), 0.15...0.5 MHz : 79 dB μ V/m QP/66 dB μ V/m AV
Immunity to microbreaks	10 ms
Ambient air temperature for operation	-10...35 °C for vertical installation -10...55 °C for horizontal installation
Ambient air temperature for storage	-25...70 °C
Relative humidity	10...95 % without condensation in storage 10...95 % without condensation in operation
IP degree of protection	IP20 with protective cover in place
Pollution degree	\leq 2
Operating altitude	0...2000 m
Storage altitude	0...3000 m
Vibration resistance	3 gn (vibration frequency: 8.4...150 Hz) on panel mounting 3.5 mm (vibration frequency: 5...8.4 Hz) on panel mounting 3 gn (vibration frequency: 8.4...150 Hz) on symmetrical rail 3.5 mm (vibration frequency: 5...8.4 Hz) on symmetrical rail
Shock resistance	15 gn (test wave duration:11 ms)

Dimensions

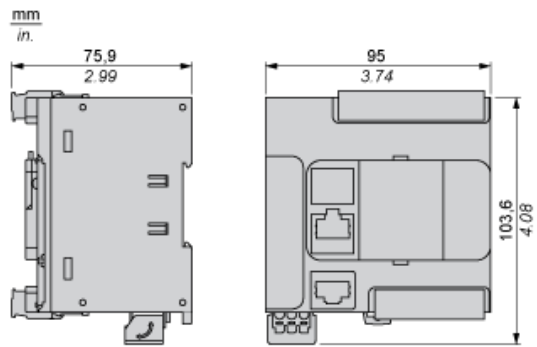

Mounting on a Rail

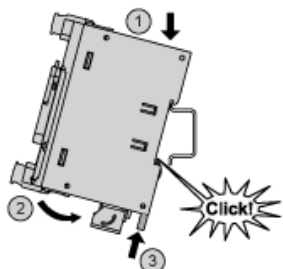

Direct Mounting on a Panel Surface

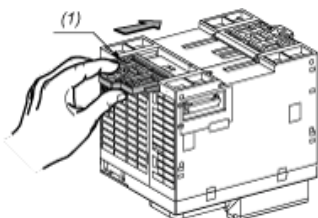

- (1) Install a mounting strip

Mounting Hole Layout

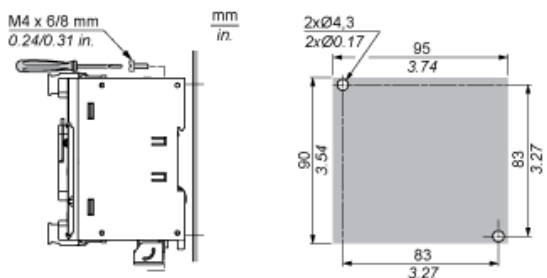

Mounting

Correct Mounting Position

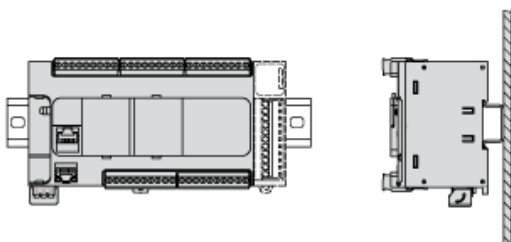

Acceptable Mounting Position

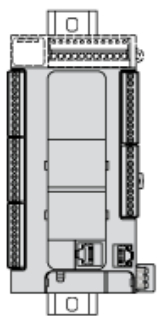

Incorrect Mounting Position

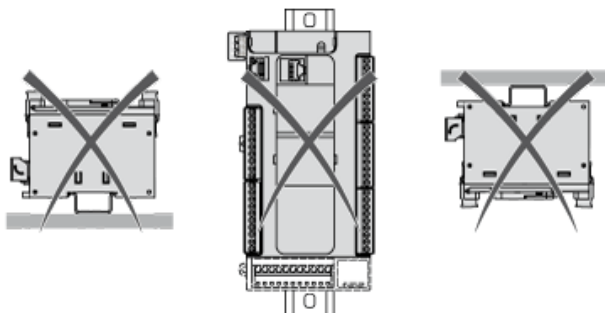

Clearance

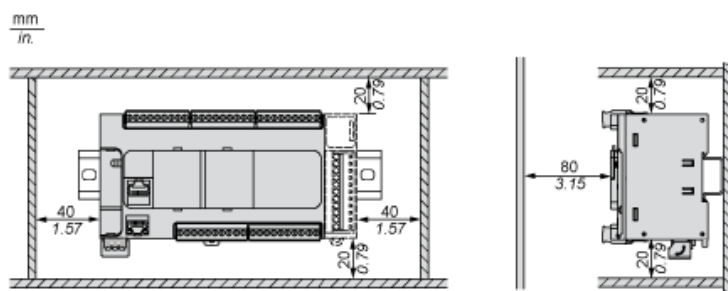

Digital Inputs

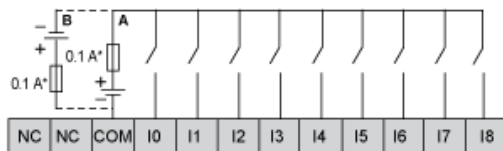

- (*) Type T fuse
- (A) Sink wiring (positive logic).
- (B) Source wiring (negative logic).

Connection of the Fast Inputs

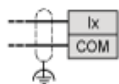

Transistor Output

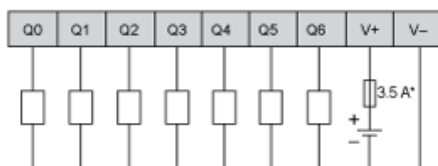

- (*) Type T fuse

Connection of the Fast Outputs

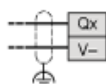

Analog Inputs

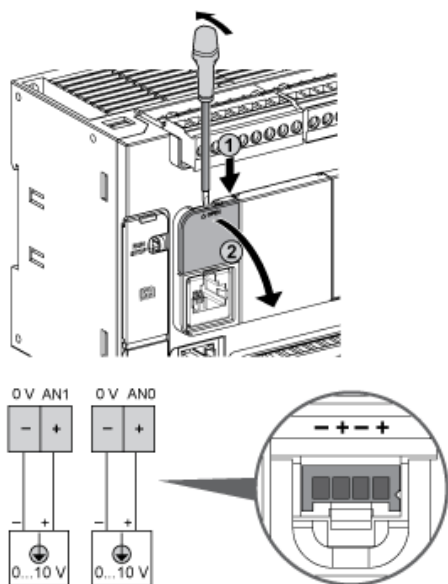

The (-) poles are connected internally.

Pin	Wire Color
0 V	Black
AN1	Red
0 V	Black
AN0	Red

USB Mini-B Connection

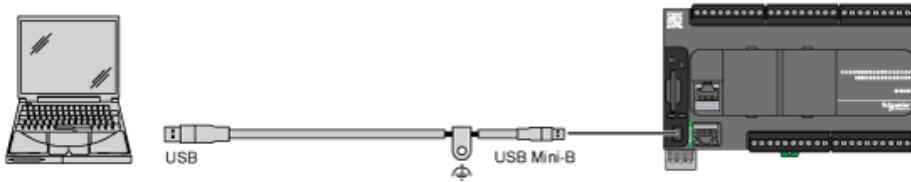

SL1 Connection

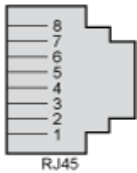

SL1

N °	RS 232	RS 485
1	RxD	N.C.
2	TxD	N.C.
3	RTS	N.C.
4	N.C.	D1 (A+)
5	N.C.	D0 (B-)
6	CTS	N.C.
7	N.C.	5 Vdc
8	Common	Common

N.C.: not connected

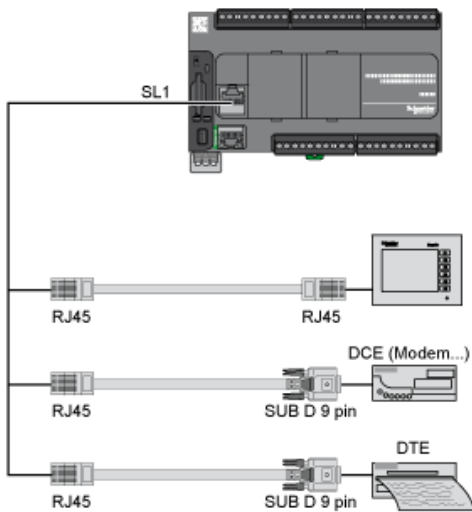

SL2 Connection

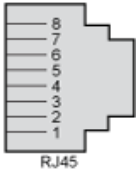

N °	RS 485
1	N.C.
2	N.C.
3	N.C.
4	D1 (A+)
5	D0 (B-)
6	N.C.
7	N.C.
8	Common

N.C.: not connected

Derating Curves

Embedded Digital Inputs (No Cartridge)

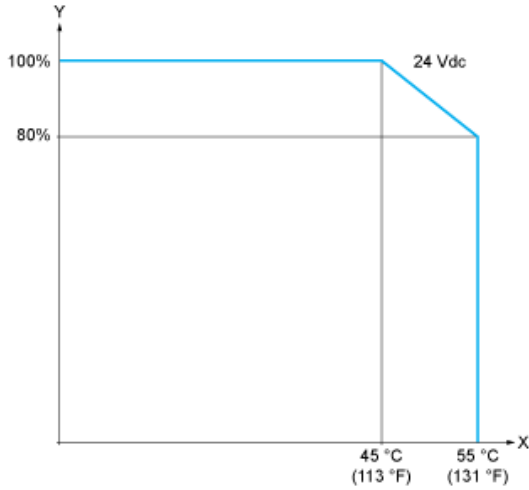

X : Ambient temperature
Y : Input simultaneous ON ratio

Embedded Digital Inputs (with Cartridge)

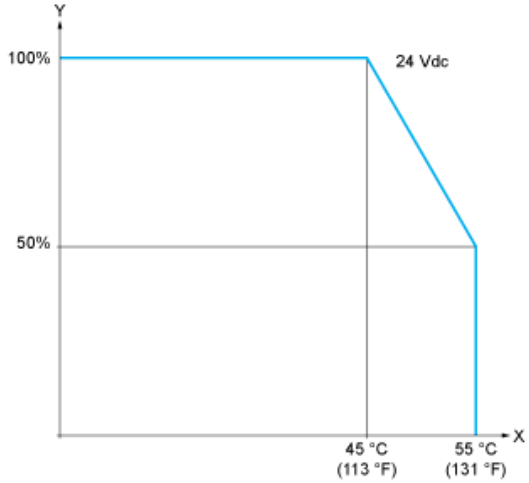

X : Ambient temperature
Y : Input simultaneous ON ratio

Derating Curves

Embedded Digital Outputs (No Cartridge)

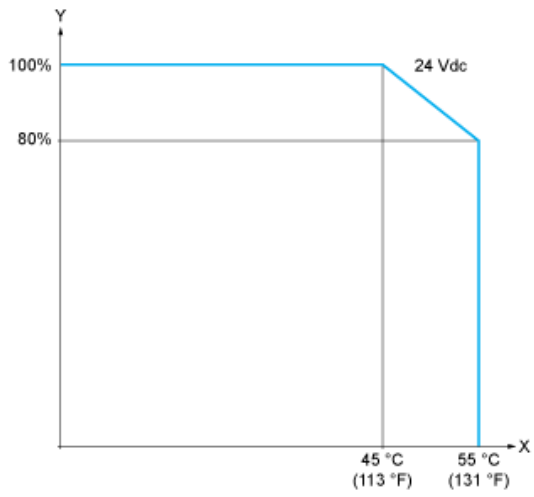

X : Ambient temperature
Y : Output simultaneous ON ratio

Embedded Digital Outputs (with Cartridge)

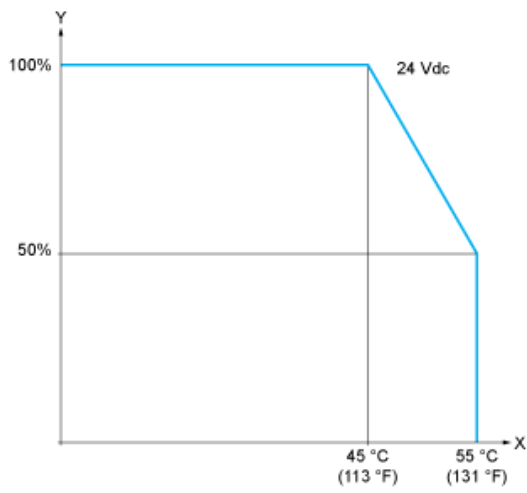

X : Ambient temperature
Y : Output simultaneous ON ratio