

# Touch Panel Applications Using MC34940/MC33794 E-Field ICs

The MC34940/MC33794 are intended for cost-sensitive applications where non-contact sensing of objects is desired. When connected to external electrodes, an electric field is created. The MC34940/MC33794 detects objects in this electric field. The IC generates a low-frequency sine wave, which is adjustable by using an external resistor and is optimized for 120 kHz. The sine wave has very low harmonic content to reduce harmonic interference. The MC34940/MC33794 also contains support circuits for a microcontroller unit (MCU) to allow the construction of a two-chip E-field system.

## Features

- Supports 7 or 9 Electrodes
- Shield Driver for Driving Remote Electrodes Through Coaxial
- High-Purity Sine Wave Generator Tunable with External Resistor
- Response Time Tunable with External Capacitor
- Can support up to 28 touch pad sensors (MC34940)
- Pb-Free and RoHS compliant (MC34940)

## Contents

<a href="#">1.0 E-Field Sensing: An Alternative Solution to Control Panel Applications .....</a>	<a href="#">2</a>
<a href="#">2.0 How the MC34940/MC33794 E-Field Sensors Work .....</a>	<a href="#">2</a>
<a href="#">3.0 Using the MC34940/MC33794 for Touch Control Applications .....</a>	<a href="#">3</a>
<a href="#">3.1 Electrode Design .....</a>	<a href="#">4</a>
<a href="#">3.2 Dielectric Material for Panel Coverings ..</a>	<a href="#">13</a>
<a href="#">3.3 Environment Effects .....</a>	<a href="#">16</a>
<a href="#">4.0 Summary .....</a>	<a href="#">21</a>

# 1.0 E-Field Sensing: An Alternative Solution to Control Panel Applications

Human touch can be a useful tool. Control panels, appliances, heavy machinery, toys, lighting controls, and anything that has a mechanical switch or push button requires some sort of human interaction to operate. Traditionally, push buttons are made out of mechanical switches and/or multi-layer resistive touch pads that can deteriorate and become less dependable over time. This is because most of these switches require physical displacement and pressure which are susceptible to wear-out, contact bounce, corrosion and arcing.

The MC34940/MC33794 Electric Field Imaging devices from Freescale offer an alternative to mechanical push buttons for control panel applications. The MC34940/MC33794 Integrated Circuits (IC) contain the circuitry necessary to generate a low level electric field and measure the field loading caused by objects moving into or out of the field. It is ideal for applications that require non-contact sensing, proximity detection, and three-dimensional e-field imaging. The ICs integrate support for a microcontroller and 7 to 9 electrodes, which can be used independently to determine the size or location of an object in a weak electric field.

With the MC34940/MC33794, membrane switches and resistive touch pads can be replaced with an array of touch pads consisting of conductive electrodes embedded beneath an insulating surface. Since it has the capability of sensing touch and proximity through the insulating surface, without direct electrical contact with the electrode metal, problems of wear, contamination, and corrosion are eliminated. This capability is also important for sophisticated touch control applications, including a user interface panel that is sensitive to different degrees of proximity — enabling the system to go from standby to active mode as a finger approaches the panel.

Further, one of the MC34940/MC33794 key features that surpass simple capacitive-based sensors is its on-board shield driver. Touch pads do not have to be combined and located at one centralized location. With proper shielding, coaxial cables or PCB layers can be used to connect remote touch pads up to a few meters away, while obtaining measurements as accurately as if the touch pads were directly connected to the IC. The MC34940/MC33794 does this by driving a signal on the shield of the coax or a PCB trace which closely follows the signal conductor voltage. The current which flows through the electric field between two conductors is proportional to the voltage difference between them. With little or no voltage difference between them, there is little or no current flow between the electrode conductor and the shielding trace or coax shield. In a cook top application, for example, this capability allows the activation touch pads for an individual burner to be in different places, rather than at the usual centralized location, without requiring a separate IC at each location. The same IC could be used to activate the down-draft vent and oven with their touch control near what they are controlling.

The potential for the chip goes well beyond touch panel applications. Target applications of the IC includes appliances, machine tools, security systems, and automotive safety systems. From liquid level sensing, to occupant classification, to theft detection, the applications list for the MC34940/MC33794 are growing.

## 2.0 How the MC34940/MC33794 E-Field Sensors Work

The MC34940/MC33794 electric field is derived by the oscillator circuitry within the IC which generates a high purity, low frequency, 5 V peak-to-peak sine wave. This frequency is tunable by

an external resistor and is optimized for 120 kHz. This AC signal is fed through an internal 22 k $\Omega$  resistor, to a multiplexer which directs the signal to the selected electrode or reference pin or to an internal measurement node. Unselected electrodes are automatically connected to the circuit ground by the IC.

These deselected electrodes can act as the return path needed to create the electric field current, since in order to create current flow, the current must follow a complete path: out of the electrode pin and back to the common ground of the IC GND pin. Thus, an electric field will cause a current to flow between the active electrode and any object with an electrical path to the IC ground, including deselected electrodes.

The current flowing between the electrode and its surrounding grounds will result in a voltage drop across the internal resistance. This, in turn, results in a voltage change at the pin. An on-board detector in the IC converts the AC signal to DC level. The DC level is then low-pass filtered using an internal series resistor and an external parallel capacitor. This DC voltage is multiplied, offset and sent to the LEVEL pin of the IC.

To help reduce application development cycle times, Freescale offers an evaluation module for the MC33794, called KIT33794DWBEVM and an evaluation model for the MC34940 called DEMO1985MC34940. This application note will focus on the use of the KIT33794DWBEVM, however the same principles apply for the evaluation kit DEMO1985MC34940 for the MC34940. Besides the different E-Field sensor IC, the main difference between the kits is the resolution of the onboard MCU. The KIT33794 uses an 8-bit ADC while the DEMO1985MC34940 uses a 10-bit ADC. When applying the data in the application note to the DEMO1985MC34940 please note that all the values in this note were recorded in an 8-bit ADC while all data reported by the DEMO1985MC34940 are reported in 10- or 12-bit values.

The KIT33794DWBEVM kit includes an MC33794DWB, a preprogrammed Freescale 68HC908QY4 8-bit microcontroller, an RS-232 communication IC, and other passive supporting components on a Printed Circuit Board. The 8-bit microcontroller converts the analog signal from the MC33794 into a 8-bit byte. The MCU transmits this value to a computer via its COM port. A Windows type program is included in the kit. This program displays the measured A-to-D value in real time along with its corresponding analog bar graph. The program can be made to scan all of the electrodes.

### **3.0 Using the MC34940/MC33794 for Touch Control Applications**

The MC34940/MC33794 can detect anything that is either conductive or has different dielectric properties than the electrodes' surroundings. Human beings are well suited for e-field imaging. This is because the human body is composed mainly of water that has a high dielectric constant and contains ionic matter which gives it good conductivity. The body also provides good electrical coupling to earth ground which can be connected to the ground return of the IC. Thus, when a finger is brought close to a metal electrode, an electrical path is formed, producing a change in electric field current that is detected by the MC34940/MC33794 and translated to a different output voltage.

The things which need to be determined in the development of an MC34940/MC33794 touch panel application are:

1. Touch pad electrode layout and design.
2. The different dielectric materials for the surface of the panel.
3. The effect on e-field measurements of various environmental conditions.

The above matters were investigated using the available KIT33794DWBEVM evaluation module. **Figure 1** displays the general setup using the kit.

Throughout the tests, all the generated data was obtained using a “calibrated” artificial finger equivalent to medium pressure applied by a finger based on actual tests and data. The artificial finger was designed to make the pressure applied to the panel consistent. The artificial finger was connected to ground and made from a copper rod with a surface area of 0.26 in<sup>2</sup> and mass of 62 grams.

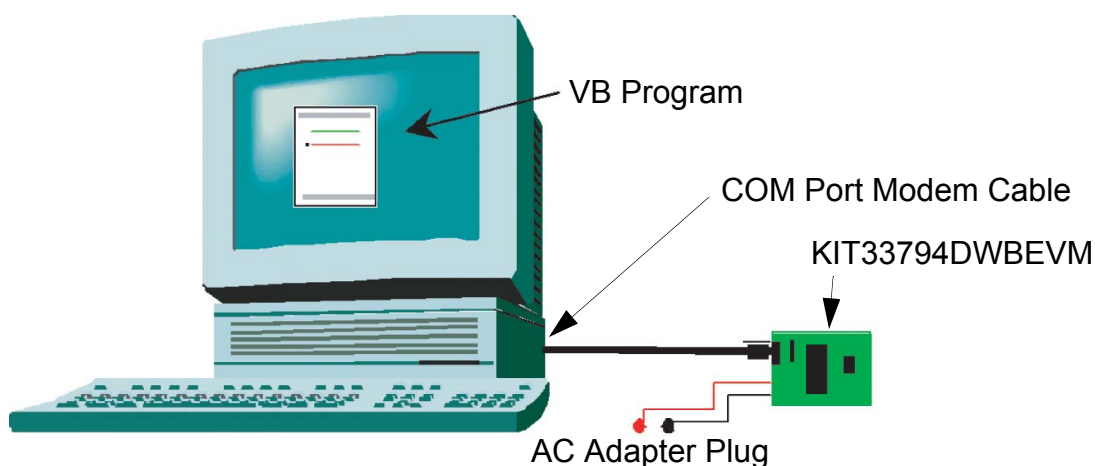

**Figure 1. E-Field Evaluation Module Setup**

### 3.1 Electrode Design

To understand how electrode designs effect the IC’s capabilities, it is important to understand the basic definition of a capacitor. A common capacitor uses an electric field and an insulating dielectric to allow current conduction to occur. It can be made by placing two metal plates in parallel with each other if the plates are separated by a distance “d” with each plate having an area of “A.”

The capacitance of the capacitor can be calculated using the formula:

$$C = (kA\epsilon)/d$$

where

C is the capacitance of the capacitor in Farads

A is the area of the plates in meter<sup>2</sup>

d is the distance between the plates in meters

k is the dielectric constant of the material between the plates

$\epsilon$  is the permittivity ( $8.85 \times 10^{-12}$  F/m)

From the above equation, it can be seen that area ( $A$ ), distance/spacing ( $d$ ), and the dielectric constant ( $k$ ) are the three factors that affect the magnitude of the capacitance. At a given frequency and voltage of an applied signal, the capacitance controls the resulting electric field current flow. The output of the MC34940/MC33794 responds to variations in this current.

### 3.1.1 Size Matters

An electrode can be anything that is electrically conductive. When designing the electrodes for any application, one must take into account the physical size of the conductive electrode. The larger the electrode, the more range and sensitivity will be obtained. However, as the electrode size is increased, so is its susceptibility to interference, electrical noise, and “stray” electric-field paths in its surroundings. One of the key practices regarding electrode design is for the electrode’s area to correspond with the surface area of the object being detected. Touch pads for touch panel applications, for example, would only require a size that suits the surface area of a finger.

### 3.1.2 Spacing

The area of the touch pads only needs to accommodate the contact area of the finger. This limits its usable size. Therefore, the distance or spacing factor will play a significant role on how the electrode should be laid out. Another factor which needs to be considered is how the fringing between the patterns adds to electric field current.

Some of the electric field current will flow in the fringing field between a pair of electrodes. **Figure 2** shows the direct field path between two conductors which are end-to-end and a few of the fringing field paths between the electrodes. If the ratio of the fringing field path to the direct path is held constant, the height of the fringing field relative to the plane of the electrodes increases in direct proportion with the spacing. **Figure 2** shows pictorially how the height of the fringing field relative to the electrodes becomes greater as the two electrodes are moved further away from each other.

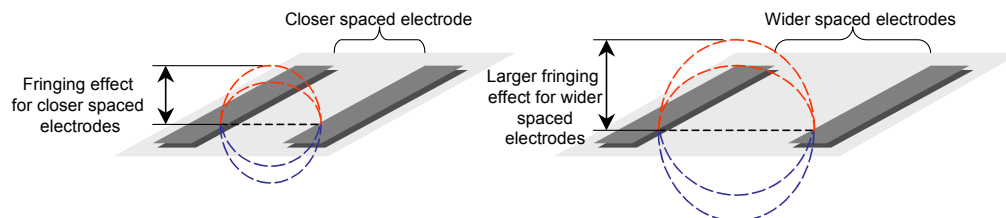

**Figure 2. Fringing Fields and the Effects of Spacing**

This fringing field allows an ungrounded object to be sensed in the “third” dimension above the essentially two dimensional array of electrodes, and the relative sensitivity for a given height above the plane of the electrodes increases with electrode spacing. It is important to note that the total current flow decreases with increased spacing. The point of this is that there is interaction between electrode size and spacing and their ability to sense objects in the third dimension. In the case of a grounded object, the fringing field will not play as much of a role since

some of the current will flow directly to the grounded object from the electrode, but good electrode design should keep both of these effects in mind.

The MC34940/MC33794 works best when the total capacitance between an electrode and ground or another electrode close to 50 pF, when the finger is in the “activate” range. The total system capacitance should be below 75 pF and preferably below 65 pF for best sensitivity. This includes the IC pin, PWB trace, wire, and any other stray capacitance. Large electrodes should be used when distances are great, and small electrodes when distances are small.

### 3.1.3 Significance of Ground — Single Electrode Sensing

The placement of ground is important. As mentioned earlier, electric field currents can exist between the active electrode and any grounded object. By intertwining the electrode with ground, the essential ground source needed to create an e-field is directly accessible to the electrode. This path is less variable than the path through a body and earth and provides a more predictable and less noisy path.

To investigate how variables in ground can effect the e-field measurement, we tested the ground phenomena with a two electrode design, a spiral and an inter-digitated layout. In addition, the width of the ground electrode intertwined with a signal electrode was varied to determine how much ground area affects the readings. One electrode-ground test configuration was designed with ground having the same width as the electrode, and another with the ground electrode thinner than the signal electrode. We designed touch pads which had an area large enough to accommodate a typical finger in a square shape with a length and width of 0.6 in. The dimensions of the electrodes are displayed in **Figure 3**.

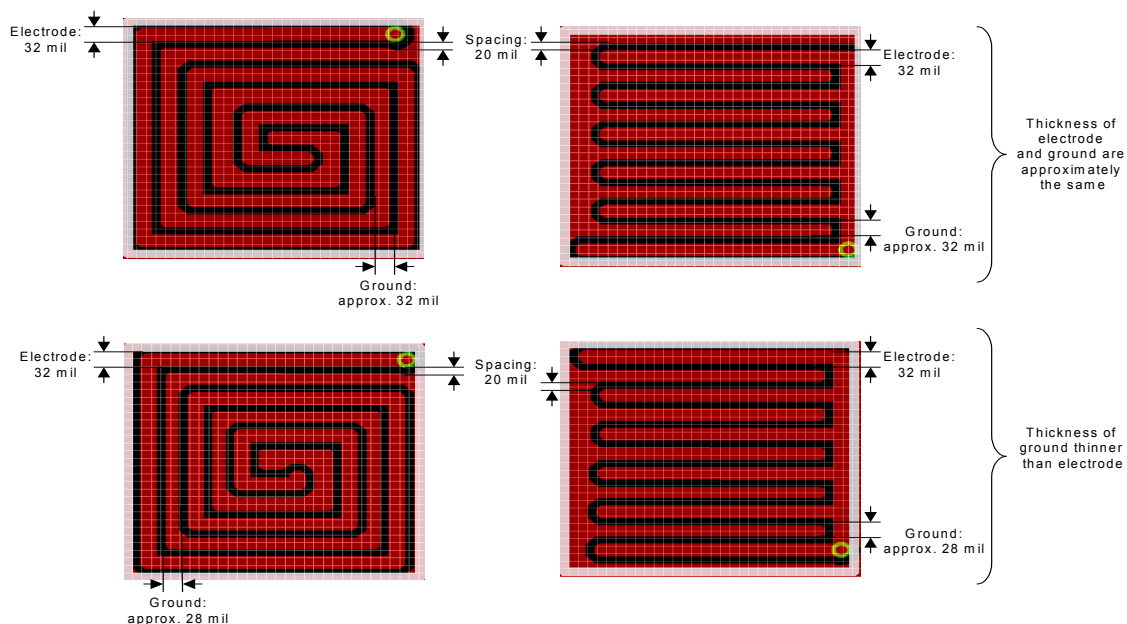

**Figure 3. Intertwined Electrode and Ground Designs and Dimensions**

The e-field loading for each touch pad is displayed in **Figure 4**. This figure shows the difference in measurement, not the absolute reading of the electrodes. A 4.5 mil (.0045) thick vinyl film was

used as an insulator over the patterns. The 2 top bars show the readings for a ground with the same width as the electrodes. The bottom 2 are for the electrodes where the grounded electrode is thinner than the signal electrode. The bar graph shows that the layout with the narrower ground electrode provided a slightly greater amount of difference in comparison to the design with ground having the same width.

The practice of intertwining electrodes with ground is more important when the electrodes connected to the IC's pins are at a distance from each other. When electrodes are close to each other, the adjacent electrodes could act as the ground source needed to create the field current. This is due to the IC connecting the deselected electrodes to ground; making the deselected electrode often act as the ground return path needed to allow an electric field current to flow.

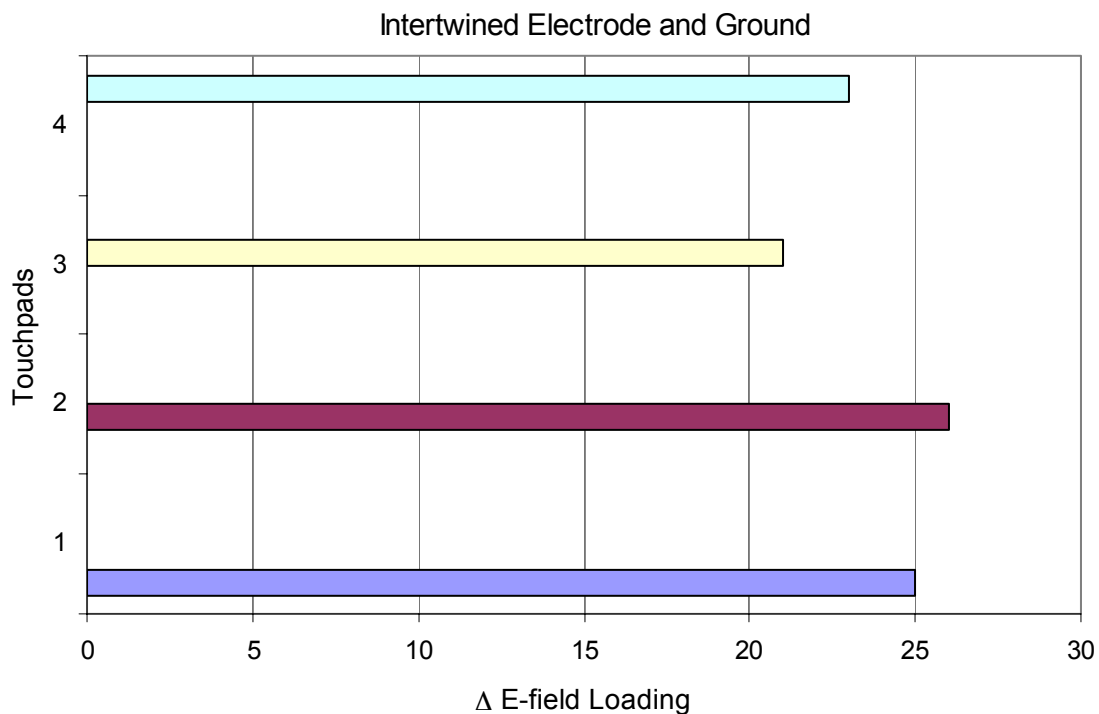

Figure 4. Results of Electrode-Ground Configuration Multiplexed Electrodes

### 3.1.4 Multiplexed Electrodes

A single MC34940/MC33794 can support as many as 7/11 electrodes which can be used independently to map the location and area of an object. By employing multiple electrodes, it is possible to get an idea about the size and shape of an object influencing the MC34940/MC33794's electric field depending on which electrodes indicate a change in their electric field current.

A panel that requires only a few push buttons could use a single electrode for each touch pad. Doing this would limit an application using a single MC34940/MC33794 to a maximum of 7/11 simple single element electrode buttons, corresponding to the 7/11 available electrode pins in the

IC. By intertwining multiple electrodes in each touch pad, many more touch pads could be supported by a single MC34940/MC33794.

To determine the best method to maximize the use of the available electrode connections on the IC, a number of design layouts were analyzed. For this investigation, we designed touch pads that had two, three, and four intertwined electrodes.

When integrating multiple electrodes in one touch pad, the electrode was laid out so that when a finger is over a touch pad, there is an even distribution of the finger's surface area over each of the electrodes. Numerous geometric arrangements and shapes were investigated to determine the best way to construct the electrodes in a square area. The inter-digitated configuration like the two right side drawings in [Figure 4](#) were found to be the best layout for intertwining two electrodes when a thin membrane is used to cover the touch pads. When a thick overlay (4 mm glass) is placed above the touch pads, it is best to use a pattern that maximizes the surface area of the button. The inter-digitated had two comb-like patterns with the teeth of the combs meshed with each other but not touching each other. An inter-digitated configuration allows for an exact distribution of each electrode and allows the system to detect the same loading from each electrode when in the presence of a finger.

Further extending this idea, two electrodes in a single touch pad could be organized by multiplexing the electrode following a column-row configuration. Increasing the number of rows and/or columns in the array will provide more electrode combinations. With this configuration, a single IC could detect as many as 20 individual push buttons. [Figure 5](#) highlights the column-row configurations.

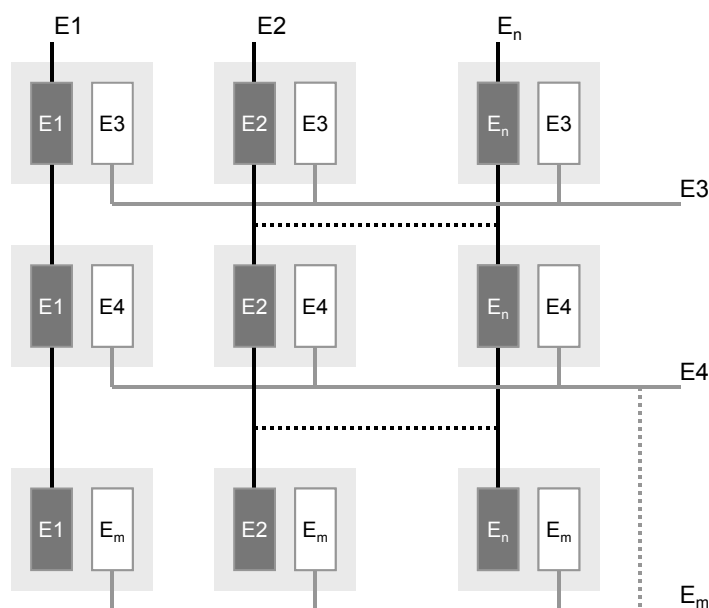

**Figure 5. Multiplexed Electrodes Following a Column-Row Configuration**

The electrode layout gets more complex as the number of electrodes in each touch pad increases. For three intertwined electrodes, a spiral like geometry is suitable as shown in [Figure 6](#). Although the exposed electrode surface areas are not exactly equal to each other, when a finger is placed over the center of the pad, the currents will be reasonably close to the same. For four intertwined electrodes, the layout design had electrodes following an “S” shape.



Again, when a finger is over the center of the pad, it would be able to cover the majority of each electrode's exposed area.

When intertwining five or more electrodes, the design gets more complex. One must take into account the size of the available area for the touch pads when determining the maximum number of electrodes in a touch pad. The number of electrodes is limited by the width and spacing requirements of the electrodes and the minimum area of each electrode for the required sensitivity.

Earlier, we discussed electrodes which were intertwined with ground in order to form a path for the field current. In a multiplexing configuration, a separate ground does not have to be intertwined because the IC automatically connects the unselected electrodes to ground. For example, in the case of the two intertwined electrodes following an inter-digitated configuration and connected to *E1* and *E2*, when *E1* is selected, *E2* (the deselected electrode) acts as the ground return to produce the field current between the two electrodes. After the system has gone through the measurement process for *E1*, the role of the two electrodes are then reversed (e.g. *E2* is selected for measurement while *E1* is connected to ground). The same phenomenon is present for touch pads with three and four intertwined electrodes.

These layouts were tested using a 4.5 mil vinyl covering. The difference in loading can be seen in the graph of [Figure 6](#).

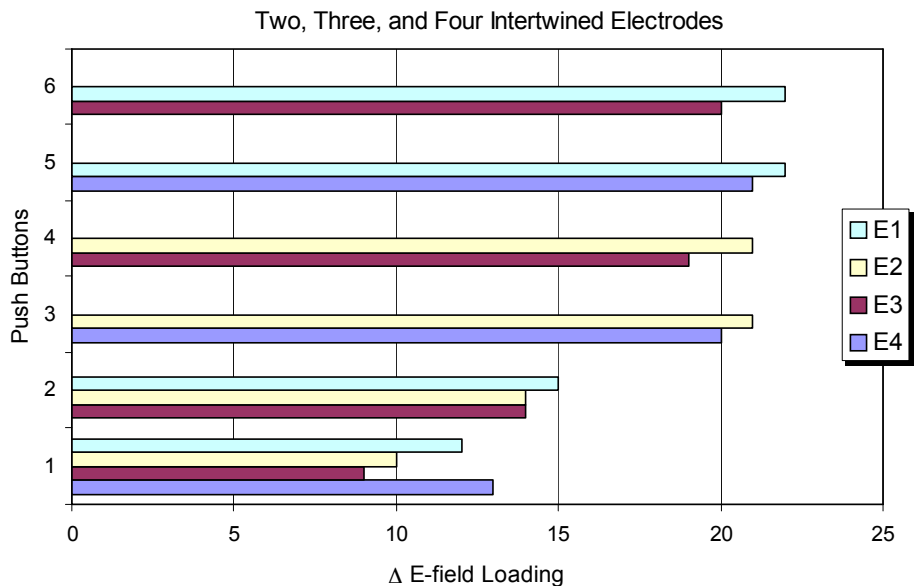

**Figure 6. Difference in E-Field Loading Resulting from 2, 3, and 4 Intertwined Electrodes in a Push Button**

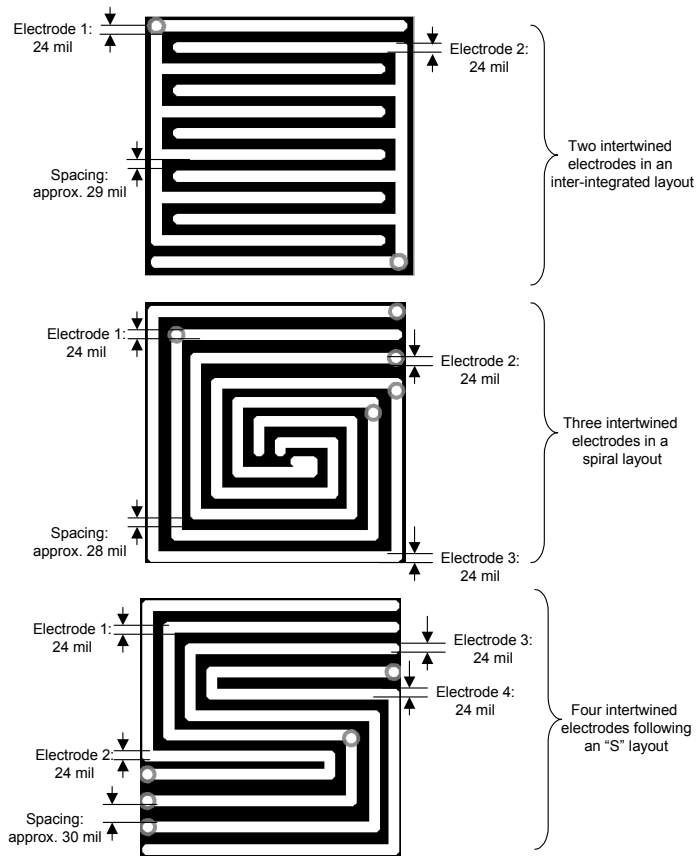

**Figure 7. Two, Three, and Four Electrodes Ideally Intertwined to Form a Touch Pads**

The top four bar pairs of the graph display the value obtained having two intertwined electrodes (like [Figure 3](#)). The measurements are very similar to each other. For the three intertwined electrodes, the difference in measurement is still visible, having about a third less magnitude than the ones with two intertwined electrodes. The reading from a touch pad with four intertwined electrodes shows even lower sensitivity. The reduction in sensitivity as the number of intertwined electrodes is increased is due to the reduction of area in each of the electrodes.

The reduction of sensitivity as the number of intertwined electrodes is increased can be offset by a thinner or higher dielectric constant cover over the touch pads. Conversely, the thickness and dielectric constant of the covering may limit the number of inter-twined electrodes.

The electrode layout and design used to measure the data in [Figure 6](#) is displayed in [Figure 7](#). Where 2 bars are together in [Figure 6](#), the bars are showing the different measurements for each electrode when using 2 intertwined electrodes in the touch pads. Three bars together are for 3 intertwined electrodes and the group of four are for 4 intertwined electrodes in touch pads.

The number of touch pads supported by the available electrode connections is more than a simple multiplexing scheme might appear to indicate. Touch pads made of 1, 2, 3, 4 or more electrodes can all be used in the same system. For instance *E1* could be intertwined with a circuit ground electrode to form a touch pad which would show only *E1* being affected when it is selected by a finger. In the same application *E1* and *E2* can be intertwined to form a touch pad so that a finger selecting it would affect both electrodes. Since both electrodes are affected in this

touch pad and only *E1* was affected in the other touch pads, the one being selected can be determined.

**Table 1** shows the 45 touch pads electrode combinations possible using 1 and 2 electrodes per touch pad with the 9 electrodes available on the MC33794. This gives some idea of the power of electric field multiplexing. If combinations of 1, 2 and 3 electrodes were used per touch pad, the number of possible unique touch pads a single MC33794 could support grows to 126!

**Table 1. 1 and 2 Electrode Touch Pad Combinations**

Electrode=> touch pads	A	B	C	D	E	F	G	H	I	Electrodes touch pads
↓										↓
1	X									1
2		X								1
3			X							1
4				X						1
5					X					1
6						X				1
7							X			1
8								X		1
9									X	1
10	X	X								2
11	X		X							2
12	X			X						2
13	X				X					2
14	X					X				2
15	X						X			2
16	X							X		2
17	X								X	2
18		X	X							2
19		X		X						2
20		X			X					2
21		X				X				2
22		X					X			2
23		X						X		2
24		X							X	2
25			X	X						2
26			X		X					2
27			X			X				2
28			X				X			2
29			X					X		2
30			X						X	2
31				X	X					2
32				X		X				2
33				X			X			2
34				X				X		2
35				X					X	2
36					X	X				2
37					X		X			2
38					X			X		2
39					X				X	2

Table 1. 1 and 2 Electrode Touch Pad Combinations (continued)

Electrode=>	A	B	C	D	E	F	G	H	I	Electrodes
40						X	X			2
41						X		X		2
42						X			X	2
43							X	X		2
44							X		X	2
45								X	X	2

### 3.1.5 Electrode—Isolated or a Unit?

Electrically conductive electrodes can be attached directly to the MC34940/MC33794 electrode pins via wire or coax cable. The IC SHIELD pin allows coaxial cable to be used without reducing sensitivity or adding variations due to changes in the coax capacitance. The signal from the SHIELD pin is a buffered version of the signal driving the selected electrode. It has the same amplitude and phase. This reduces amplitude of the electric field between the center conductor and the shield of the coax to nearly 0. This results in nearly zero field current between them and doesn't add to the field current at the electrodes.

The electrodes of a touch pad can be formed directly on Printed Circuit Boards (PCB) using copper circuit traces. We formed the electrodes used in [Figure 3](#) (electrode intertwined with ground) and [Figure 6](#) (two, three, four intertwined electrodes) this way. The field current of the wires used to connect the IC pins to the electrodes was reduced by placing a copper layer connected to the shield pin over the signal traces. This is shown in [Figure 8](#). This practice also hides the exposed wires from the plate to be contacted by the user. This prevents false indications of a touch when a finger touches an area above the routing traces.

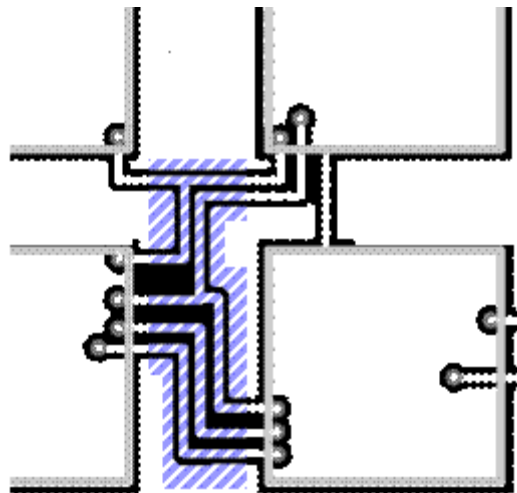
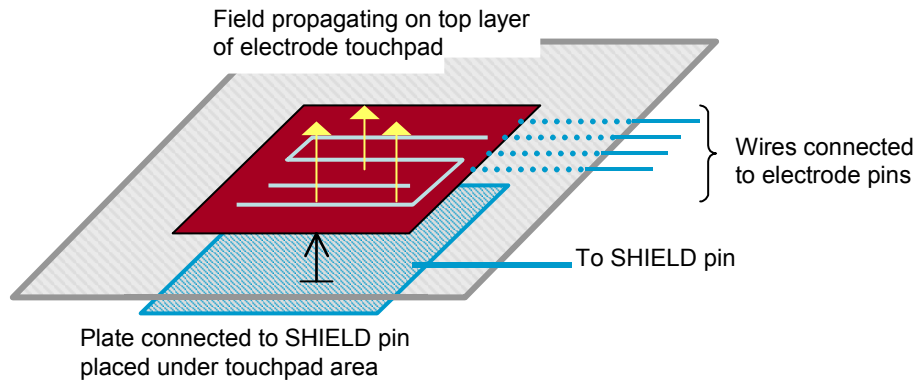

Figure 8. Wires Covered with Conductive Plate Connected to the SHIELD Pin to Minimize Effective Capacitance of Wire

Further, an electric current could flow in the field created from the touch pad to an object above or below it. Since we want the field to only propagate on top of the touch pads, [Figure 9](#) shows how we eliminated the effective capacitance on the back side of the touch pad by placing a conductive layer under all of the touch pads and connected it to the shield driver pin of the IC.



**Figure 9. Shielded Conductive Plate Placed Under Touch Pads to Remove Bottom Fringing Path**

When touch pads are close together, it is possible that a finger could be over more than one touch pad at a time. In this case, the analog levels from the IC can be used to determine which of the electrodes has more coverage. In a column-row configuration, for example, when a finger with its surface area distributed between buttons A and B (as in **Figure 10**), *E1* will attain a great amount of loading, while *E3* and *E4* will also detect some difference in measurements. Software can determine which of the electrodes (*E3* or *E4*) will have a higher amount of loading difference. The higher reading of *E3* or *E4*, when combined with *E1* would then be chosen to perform whatever particular task was intended.

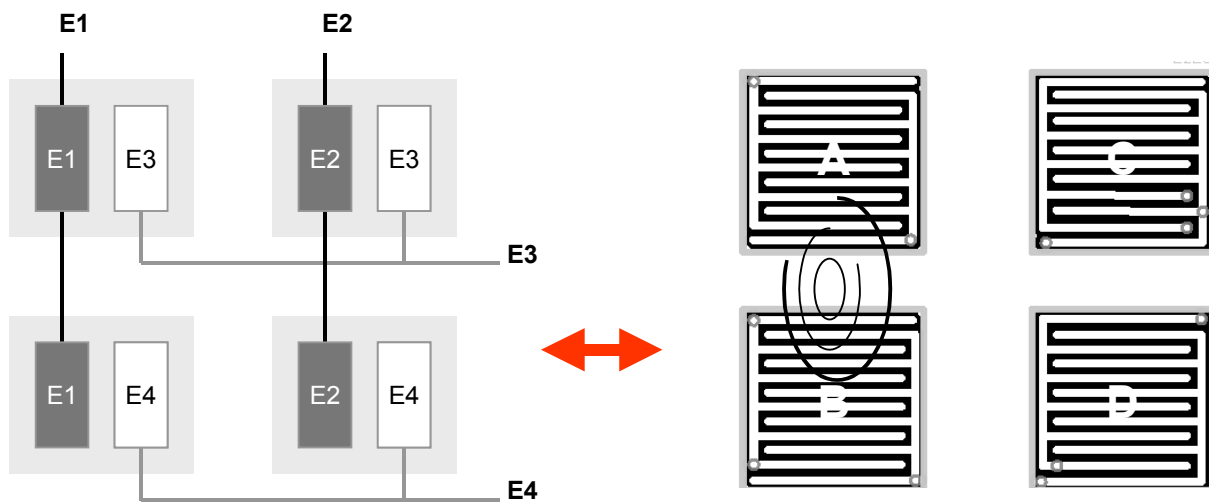

**Figure 10. An Array of 2x2 Inter-Integrated Electrodes Following a Column-Row Configuration**

### 3.2 Dielectric Material for Panel Coverings

In order to have a non-direct electrical connection, electrodes must be covered with an insulator. When selecting the proper material for the surface of the touch panel, one must take into

consideration the thickness and the composition of the material. The thickness and the dielectric constant of the insulator both play a significant role in the sensitivity of the system.

To determine how the e-field is affected by the insulator's thickness and composition, we tested the touch panel setup with the different materials and thicknesses listed in [Table 2](#).

**Table 2. Dielectric Materials with Different Thicknesses and Dielectric Constants**

Dielectric Material	Thickness (mil)	k
Acrylic	84.5	2.7-4.5
Glass	74.5	7.5
Nylon Plastic	68.0	3.0-5.0
Polycarbonate	61.0	2.9-3
PVC (Polyvinyl chloride)	59.5	3.18
Polystyrene	43.0	2.4-2.6
Soft Neoprene Rubber	38.0	5
Polypropylene	14.0	1.5
Polyester Film	10.0	3.2
Flexible Vinyl Film	9.0	2.8-4.5
Air	-	1
Water	-	80
Ice	-	3.2

Data for [Figure 12](#) through [Figure 16](#) was obtained using an inter-digitated touch pad configuration with the same dimensions as in [Figure 3](#). Note that throughout the experiment, the existence of air ( $k = 1$ ) was minimized between the cover and the electrode in order to obtain the best results.

### 3.2.1 Dielectric Constant

A material with high dielectric constant ( $k$ ) will help propagate the field through to the front of the panel better than a low dielectric constant material, enabling the system to better detect an object at the surface.

As seen in [Figure 12](#), the difference in e-field measurements was quite noticeable between polypropylene, polyester film, and flexible vinyl film. Also notice that despite the greater thickness of the flexible neoprene rubber, a very large difference in loading was noted. This is due to its high dielectric constant and, perhaps, its pliable nature. Neoprene ( $k = 5$ ) allows the field to propagate through it with around 3 times the magnitude of polypropylene plastic ( $k = 1.5$ ).

In general, the results show what we would expect. Increasing thickness reduces sensitivity. Increasing dielectric constant increases sensitivity. A good example is the comparison between glass and nylon. The glass is thicker than the nylon but shows a larger change because of its higher dielectric constant.

### 3.2.2 Insulation Thickness

An interesting exception to this generalization is soft neoprene rubber. Its dielectric constant is, at best only twice that of flexible vinyl film but its thickness is more than 4 times as much. The sensitivity is around twice as much. It would be expected to be half as sensitive. One possible explanation for this is the compliance of the rubber and its porosity. As the rubber is compressed, the small internal air pockets get squeezed such that more of the path is through the solid part of the rubber which has a much higher dielectric constant. If this theory is correct, the dielectric

constant effectively increases as pressure is put on it. Further, the thickness is reduced as pressure is put on the rubber which would also increase the amount of change. The bottom line is that soft neoprene rubber would make a great covering for the electrodes.

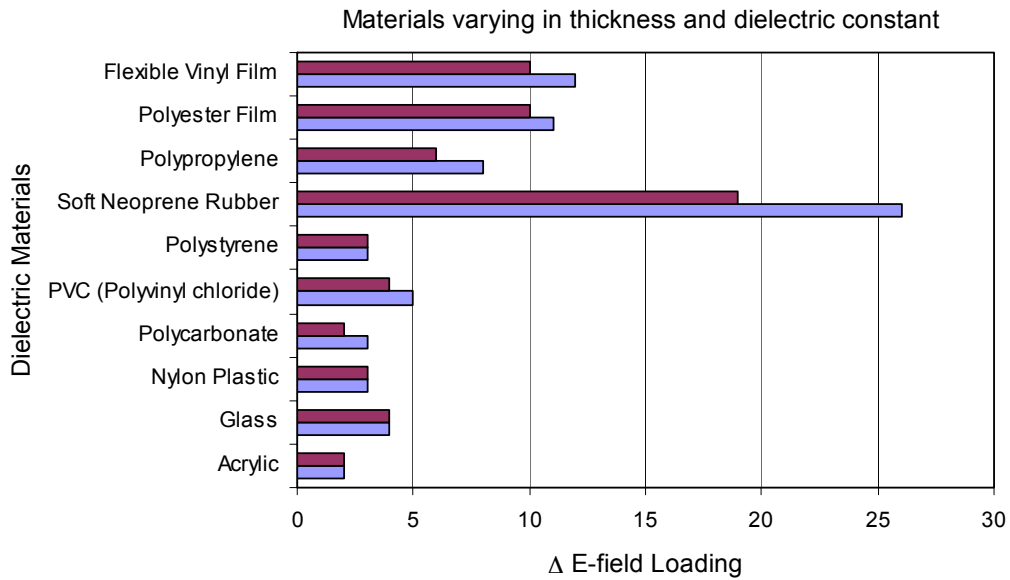

**Figure 11. Difference in E-Field Loading with Varying Materials as Panel**

In general, the thinner the insulation, the more sensitive the touch pads are to touch. In order to investigate this more thoroughly, the same test was applied for polyester film ( $k = 3.2$ ) with thicknesses that varied from 1 mil to 10 mils. The tests were done using 2 inter-digitated electrodes. The results are shown in [Figure 12](#). The strong relationship between thickness and sensitivity is quite visible in this curve.

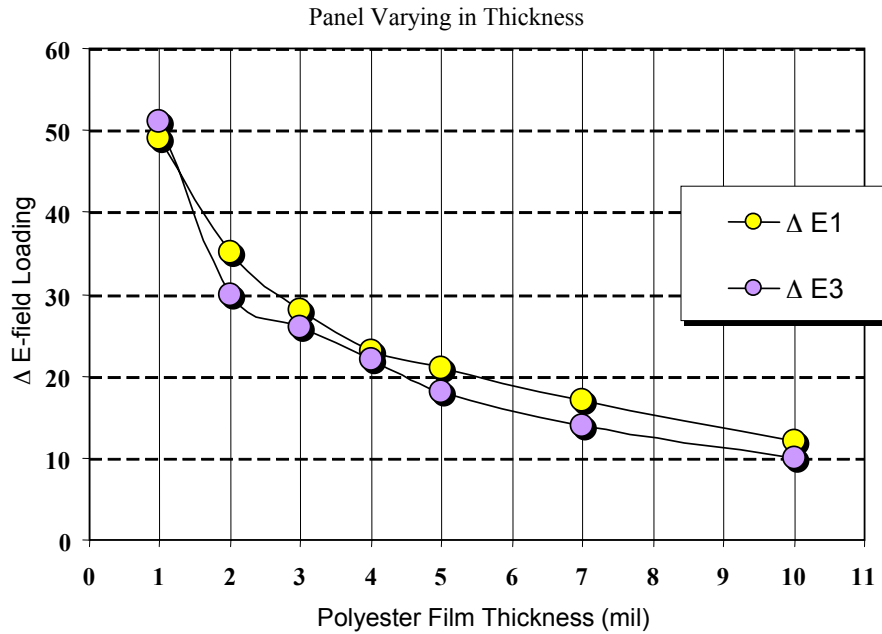

Figure 12. Data with Polyester Film ( $k = 3.2$ ) Varying in Thickness

### 3.3 Environment Effects

The different dielectric materials from [Table 1](#) were tested under various conditions to determine the effect of moisture or oil on the surface and for the effect of gloves. This was done to measure how naturally occurring conditions might affect an application using this technology. Moisture is often encountered in outdoor applications, and oils can build up when people touch the panel.

#### 3.3.1 Influence of Oil and Moisture

[Figure 13](#) shows the results obtained with oil on the surface. The oil did not significantly affect the readings, due to the low dielectric constant of oil (vegetable oil,  $k = 3$ ). Comparing the results with that of [Figure 11](#), it can be seen that the oil film on top of the material actually improved the detection of the finger. This is due to the oil filling the air gaps in the finger print. Its higher dielectric constant increased the amount of current created by the field.



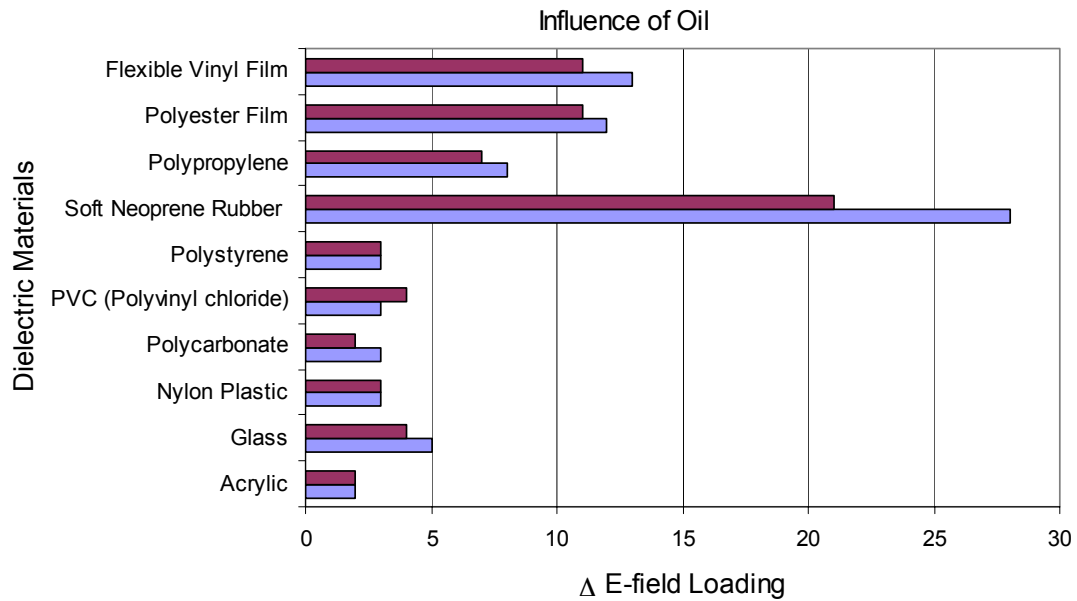

**Figure 13. Difference in E-Field Loading Under Influence of Oil (k = 3)**

Water was put on the surface of the panel and the data in [Figure 14](#) was obtained. The amount of change in the output was better than when using oil. It was noticed that there was more effect on the adjacent touch pads. This is probably due to the higher current path provided by the high dielectric constant water from the finger to the other electrodes. This could be a problem requiring some change in the physical design of the panel. Wider separation of the touch pads reduces the effect. The slope of the panel to make water run off it would help. A material which “sheds” water might also be beneficial.

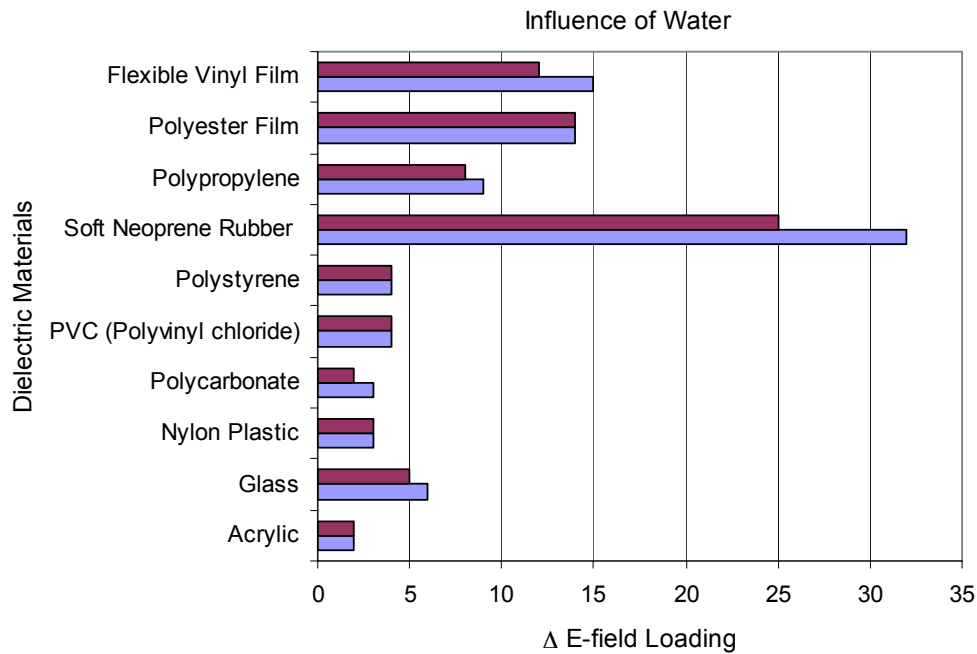

Figure 14. Difference in E-Field Loading Under the Influence of Water (k = 80)

### 3.3.2 Effect of Gloves

Another test applied to the system was that of using a gloved finger. The data shows that a gloved finger is difficult to detect. The gloves add distance between the surface of the panel and the finger. The glove used in the experiment was rather thick and was made of cotton materials with dielectric constant close to air ( $k = 1.3-1.4$ ). The data is shown in [Figure 15](#).

For this application an electrode that is responsive to a degree of pressure would be more suitable. Instead of depending on the finger's capacitance, a conductive membrane could be embedded behind a flexible panel and would alter the reading based on the applied pressure.

Another option is based on the large amount of change that was detected from the soft neoprene rubber. This gave rise to another experiment. A piece of neoprene was placed above the electrode in such a way that there was a gap of air between the electrode and the rubber. When pressure was placed on top of the rubber by a finger, the air between the rubber and the electrode was eliminated and a great amount of difference (almost a count of 40) was detected. This was because the field current is primarily limited by the low dielectric constant of air in the gap between the neoprene and the touch pads. When pressure was applied by the finger, the rubber closed this air-gap providing a lower impedance to the field current between the interwoven ground and sense electrodes.

<sup>1</sup>All the generated data was obtained using a "calibrated" artificial finger equivalent to a medium pressure applied by a finger based on actual tests and data. The rod finger is designed in an effort to keep the pressure controlled. The artificial finger is connected to ground and is made out of copper rod with a surface area of  $0.26 \text{ in}^2$  and mass of  $61900.76 \text{ mg}$ .

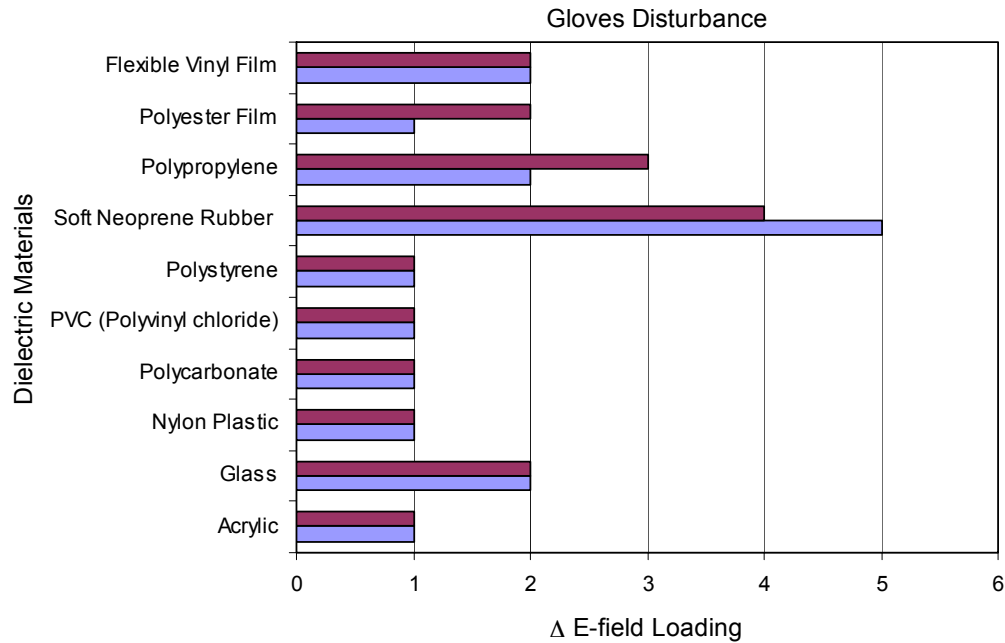

**Figure 15. Difference in E-Field Loading Measured with the Presence of a Gloved Finger**

### 3.3.3 Effects of Temperature

Another test that was conducted was observing how the MC34940/MC33794 system was affected by heat and frost.

The first occurrence observed was how the references reach a particular value for every given temperature, as shown in [Table 3](#).

Frequency and other component values may change over time or be affected by environmental variables such as temperature and humidity. To compensate for this, the MC33794 relies on two reference inputs, Ref A and Ref B, that would be connected to temperature stable capacitors. When using the MC34940, simply connect the capacitors to regular electrode inputs. When selecting the electrode to read the capacitor, allow enough time for the capacitor to charge before taking a reading. One capacitor is chosen with a capacitance near the expected minimum capacitance, while the other is chosen with a capacitance near the maximum capacitance to be expected at the electrodes. These reference capacitances and their corresponding measured voltages provide a pair of value that can be used to correct errors in the electrode measurements caused by temperature, aging or other component related changes.

The curves in [Figure 16](#) display the occurrence of increasing reference A and B values with decreasing temperature.

**Table 3. Ref A and B versus Temperature Table**

deg. Fahrenheit	-5	0	10	20	30	40	50	60	70	80	90	100	110
deg. Celcius	-20	-18	-12	-7	-1	4	10	16	21	27	32	38	43
Ref A	179	178	178	177	176	175	174	173	173	172	171	170	169
Ref B	75	74	72	69	66	64	61	58	55	52	50	47	45

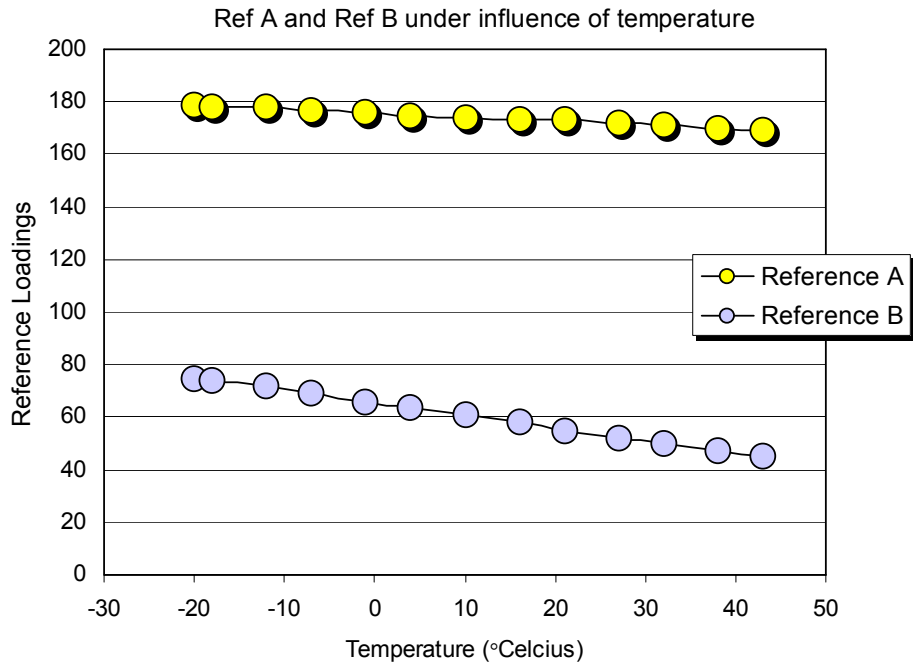

**Figure 16. A-to-D Value of Ref A and Ref B Based on Varying Temperature**

From the above lists of materials, neoprene, polypropylene, polyester and vinyl film were also tested to determine the effect on e-field measurements with variations in temperature (-20°C to 43°C).

**Figure 17** highlights the difference in loading for a touch pad with inter-digitated electrodes for different insulation materials over varying temperature. Note that the curves in **Figure 16** and **Figure 17** have opposite temperature coefficients. This is how the correction can be done. Since the capacitors don't change their capacitance over temperature, the current through them would be expected to stay the same. Since the readings do change, it can be assumed that the measurements of the unknown field currents would change a proportionate amount. The correction method is to subtract the change in the reference capacitor from the readings taken. In other words, if the reference readings go up by 3 counts, subtract 3 counts from the electrode values to obtain a "corrected" value. The best correction would use a "normalization" technique using the 2 reference values to correct for both offset and gain drift.

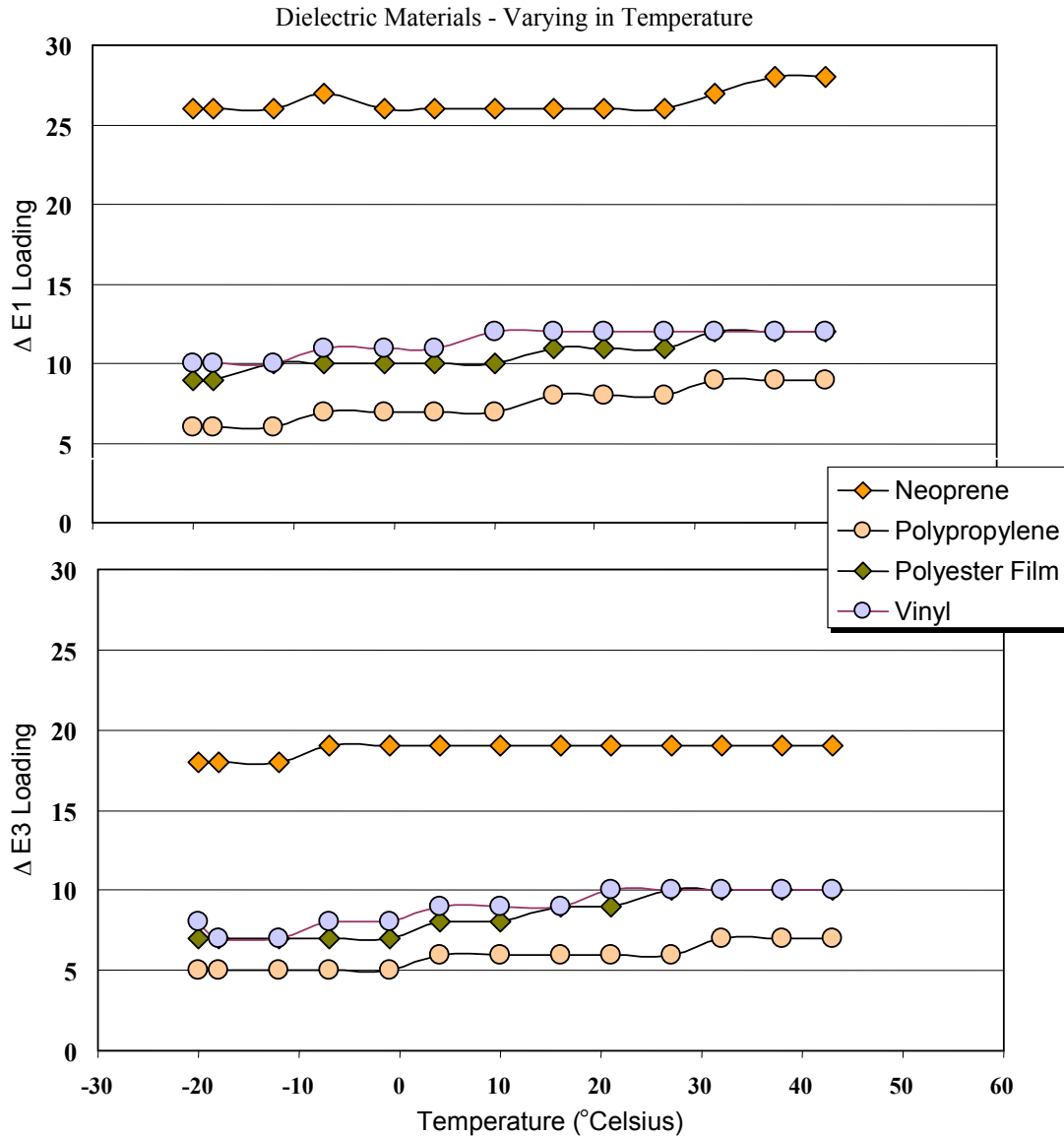

Figure 17. Difference in E-Field Loading with System Under the Influence of Varying Temperature

## 4.0 Summary

When developing a touch panel using the MC34940/MC33794 ICs the following key points should be kept in mind:

- The size of the electrode should correspond to the size of the object operating the panel, such as a finger or palm. The area of the electrodes should be made as large as possible within this constraint.
- The insulator over the touch pads should be as thin as possible with as high a dielectric constant as possible.
- Multiplexing can dramatically increase the number of touch pads supported by a single IC.

- If you anticipate that the device will be affected by excessive moisture make sure the panel is mounted at an angle to aid in water run-off.
- The reference correction method should be used to offset the effects of temperature and component drift.
- The MC34940/MC33794 can support many other things than touch controls. These devices can be maximized by using any left over electrodes for liquid level sensing and proximity detection.

## **How to Reach Us:**

### **Home Page:**

[www.freescale.com](http://www.freescale.com)

### **Web Support:**

<http://www.freescale.com/support>

### **USA/Europe or Locations Not Listed:**

Freescale Semiconductor, Inc.  
Technical Information Center, EL516  
2100 East Elliot Road  
Tempe, Arizona 85284  
+1-800-521-6274 or +1-480-768-2130  
[www.freescale.com/support](http://www.freescale.com/support)

### **Europe, Middle East, and Africa:**

Freescale Halbleiter Deutschland GmbH  
Technical Information Center  
Schatzbogen 7  
81829 Muenchen, Germany  
+44 1296 380 456 (English)  
+46 8 52200080 (English)  
+49 89 92103 559 (German)  
+33 1 69 35 48 48 (French)  
[www.freescale.com/support](http://www.freescale.com/support)

### **Japan:**

Freescale Semiconductor Japan Ltd.  
Headquarters  
ARCO Tower 15F  
1-8-1, Shimo-Meguro, Meguro-ku,  
Tokyo 153-0064  
Japan  
0120 191014 or +81 3 5437 9125  
[support.japan@freescale.com](mailto:support.japan@freescale.com)

### **Asia/Pacific:**

Freescale Semiconductor Hong Kong Ltd.  
Technical Information Center  
2 Dai King Street  
Tai Po Industrial Estate  
Tai Po, N.T., Hong Kong  
+800 2666 8080  
[support.asia@freescale.com](mailto:support.asia@freescale.com)

### **For Literature Requests Only:**

Freescale Semiconductor Literature Distribution Center  
P.O. Box 5405  
Denver, Colorado 80217  
1-800-441-2447 or 303-675-2140  
Fax: 303-675-2150  
[LDCForFreescaleSemiconductor@hibbertgroup.com](mailto:LDCForFreescaleSemiconductor@hibbertgroup.com)

Information in this document is provided solely to enable system and software implementers to use Freescale Semiconductor products. There are no express or implied copyright licenses granted hereunder to design or fabricate any integrated circuits or integrated circuits based on the information in this document.

Freescale Semiconductor reserves the right to make changes without further notice to any products herein. Freescale Semiconductor makes no warranty, representation or guarantee regarding the suitability of its products for any particular purpose, nor does Freescale Semiconductor assume any liability arising out of the application or use of any product or circuit, and specifically disclaims any and all liability, including without limitation consequential or incidental damages. "Typical" parameters that may be provided in Freescale Semiconductor data sheets and/or specifications can and do vary in different applications and actual performance may vary over time. All operating parameters, including "Typicals", must be validated for each customer application by customer's technical experts. Freescale Semiconductor does not convey any license under its patent rights nor the rights of others. Freescale Semiconductor products are not designed, intended, or authorized for use as components in systems intended for surgical implant into the body, or other applications intended to support or sustain life, or for any other application in which the failure of the Freescale Semiconductor product could create a situation where personal injury or death may occur. Should Buyer purchase or use Freescale Semiconductor products for any such unintended or unauthorized application, Buyer shall indemnify and hold Freescale Semiconductor and its officers, employees, subsidiaries, affiliates, and distributors harmless against all claims, costs, damages, and expenses, and reasonable attorney fees arising out of, directly or indirectly, any claim of personal injury or death associated with such unintended or unauthorized use, even if such claim alleges that Freescale Semiconductor was negligent regarding the design or manufacture of the part.

Freescale™ and the Freescale logo are trademarks of Freescale Semiconductor, Inc. All other product or service names are the property of their respective owners.

© Freescale Semiconductor, Inc. 2006. All rights reserved.