



## Specifications:

Mechanical Characteristic	
Motor design	Single phase, 4-poles Brushless DC motor
Bearing system	Vapo Bearing System
Dimensions	40mm × 40mm × 6mm
Materials of frame	Thermoplastic PBT
Materials of fan blade	Thermoplastic PBT
Direction of rotation	Counter-clockwise viewed from front of fan blade
Mounting holes	Diameter 3.4mm in 4 holes
Weight	6.8g

Electric Characteristic	
Rated voltage	5V DC
Rated current	65mA / Max. 75mA
Rated power consumption	0.33 Watts / Max. 0.38 Watts
Operating voltage range	2.5V DC to 5.5V DC
Starting voltage	2.5V DC (25°C power on/off)
Operating temperature range	-10°C to +70°C
Storage temperature range	-40°C to +70°C

Performance Characteristic	
Rated speed	6,000 RPM ±15% at rated voltage
Air flow	5.5CFM
Static pressure	0.08"-H <sub>2</sub> O
Acoustic noise	25.7dB(A)
Insulation resistance plastic housing	10MΩ at 500V DC between internal stator and lead wire(+)
Dielectric strength	Applied AC 500V for one minute or AC 600V for 2 seconds between housing and lead wire (+)
Life expectancy	60,000 Hours at 40°C, 65% Humidity, 90% CL.
Protection	*Automatic Restart
	Polarity Protection

\*In a situation where the fan is locked by an external force while the electricity is on, an increase in coil temperature will be prevented by temporarily turning off the electrical power to the motor. The fan will automatically restart when the locked rotor condition is released.

# DC Axial Fan



## Performance Curves

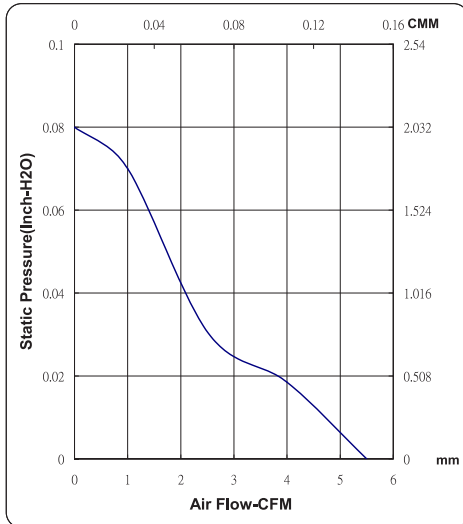

## Dimensions

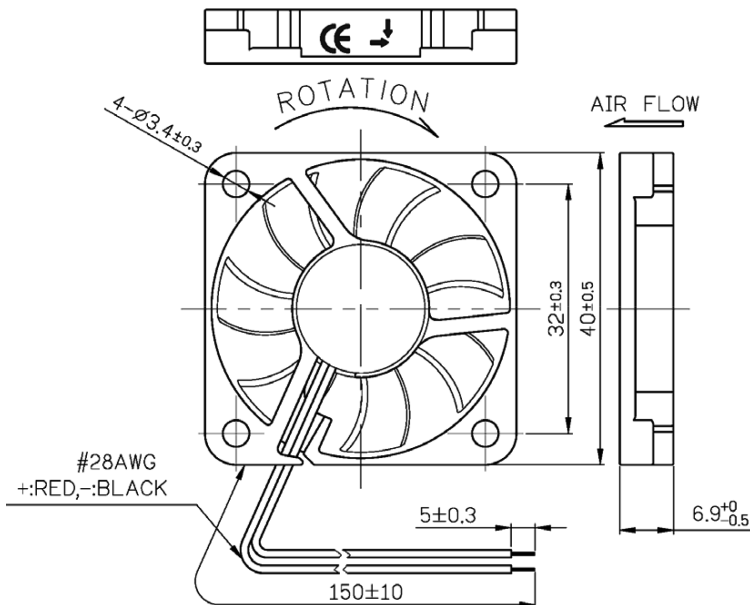

## Part Number Table

Description	Part Number
DC Axial Fan	MC36369

**Important Notice :** This data sheet and its contents (the "Information") belong to the members of the Premier Farnell group of companies (the "Group") or are licensed to it. No licence is granted for the use of it other than for information purposes in connection with the products to which it relates. No licence of any intellectual property rights is granted. The Information is subject to change without notice and replaces all data sheets previously supplied. The Information supplied is believed to be accurate but the Group assumes no responsibility for its accuracy or completeness, any error in or omission from it or for any use made of it. Users of this data sheet should check for themselves the Information and the suitability of the products for their purpose and not make any assumptions based on information included or omitted. Liability for loss or damage resulting from any reliance on the Information or use of it (including liability resulting from negligence or where the Group was aware of the possibility of such loss or damage arising) is excluded. This will not operate to limit or restrict the Group's liability for death or personal injury resulting from its negligence. Multicomp is the registered trademark of the Group. © Premier Farnell plc 2012.

