

Keysight E4981A Capacitance Meter

Data Sheet



Definitions and Specifications

This document provides specifications and supplemental information for the Keysight Technologies, Inc. E4981A capacitance meter. All specifications apply to the conditions of a 0 °C to 45 °C temperature range, unless otherwise stated, and 30 minutes after the instrument has been turned on.

Definitions

Specification (spec.):	<p>Warranted performance. Specifications include guard bands to account for the expected statistical performance distribution, measurement uncertainties, and changes in performance due to environmental conditions.</p> <p>Supplemental information is intended to provide information that is helpful for using the instrument but that is not guaranteed by the product warranty.</p>
Typical (typ.):	Describes performance that will be met by a minimum of 80% of all products. It is not guaranteed by the product warranty.
Nominal (nom.):	A general descriptive term that does not imply a level of performance.
Option dependencies	<p>The available frequency is defined as follows.</p> <p>E4981A-001: 120 Hz/1 kHz/1 MHz/1 MHz \pm 1%/1 MHz \pm 2% E4981A-002: 120 Hz/1 kHz</p> <p>The information regarding "Frequency 1 MHz/1 MHz \pm 1%/1 MHz \pm 2%" in specifications, supplemental and general information is not valid for the E4981A-002.</p>

Basic specifications

Measurement parameters	<ul style="list-style-type: none">– Cp-D, Cp-Q, Cp-Rp, Cp-G– Cs-D, Cs-Q, Cs-Rs
	where
	<p>Cp: Capacitance value measured using the parallel equivalent circuit model</p> <p>Cs: Capacitance value measured using the series equivalent circuit model</p> <p>D: Dissipation factor</p> <p>Q: Quality factor (inverse of D)</p> <p>G: Equivalent parallel conductance measured using the parallel equivalent circuit model</p> <p>Rp: Equivalent parallel resistance measured using the parallel equivalent circuit model</p> <p>Rs: Equivalent series resistance measured using the series equivalent circuit model</p>

Specifications

Measurement

Measurement signals

Frequency	Allowable frequencies	120 Hz
		1 kHz
		1 MHz
		0.98 MHz (1 MHz – 2%) 0.99 MHz (1 MHz – 1%) 1.01 MHz (1 MHz + 1%) 1.02 MHz (1 MHz + 2%)
	Accuracy	±0.02%
Level	Range	0.1 V to 1 V
	Resolution	0.01 V
	Accuracy	±5%
Output mode	Continuous or Synchronous	
Source delay time ¹	Range	0 to 1 s
	Resolution	0.1 ms

1. Source delay time is effective when output mode is set to Synchronous mode.

Measurement cable lengths: 0 m, 1 m, 2 m

Measurement time selection: 5 speeds measurement time mode N = 1, 2, 4, 6, 8
For information on the measurement time in each mode, refer to Table 15
"Measurement time."

Measurement range selection: Auto, Hold

Measurement range:

Measurement signal frequency: 120 Hz	10 nF 220 nF 4.7 μ F 100 μ F	22 nF 470 nF 10 μ F 220 μ F	47 nF 1 μ F 22 μ F 470 μ F	100 nF 2.2 μ F 47 μ F 1 mF
Measurement signal frequency: 1 kHz	100 pF 2.2 nF 47 nF 1 μ F 22 μ F	220 pF 4.7 nF 100 nF 2.2 μ F 47 μ F	470 pF 10 nF 220 nF 4.7 μ F 100 μ F	1 nF 22 nF 470 nF 10 μ F
Measurement signal frequency: 1 MHz / 1 MHz \pm 1% / 1 MHz \pm 2%	1 pF 22 pF 470 pF	2.2 pF 47 pF 1 nF	4.7 pF 100 pF	10 pF 220 pF

For information on measurable range in each measurement mode, refer to "Available measurement ranges" (Tables 2 through 4).

Averaging:

Range	1 to 256 measurements
Resolution	1

Trigger mode: Internal trigger (Int), Manual trigger (Man), External trigger (Ext), GPIB/USB/LAN trigger (Bus)

Trigger delay time:

Range	0 to 1 s
Resolution	0.1 ms

Measurement display ranges

Table 1 shows the range of the measured value that can be displayed on the screen.

Table 1. Allowable measured value display range

Parameter	Measurement display range
Cs, Cp	±1.000000 aF to 999.9999 EF
D	±0.000001 to 9.999999
Q	±0.01 to 99999.99
Rs, Rp	±1.000000 aΩ to 999.9999 EΩ
G	±1.000000 aS to 999.9999 ES
Δ%	±0.0001 % to 999.9999 %

a: 1×10^{-18} , E: 1×10^{18}

Available measurement ranges

Tables 2 through 4 show recommended measurement ranges (recommended for accurate measurement) and significant measurement ranges (ranges that do not cause overload) for each measurement value under the condition D (dissipation factor) ≤ 0.5 .

Table 2. Measurable capacitance ranges when measurement frequency is 120 Hz

Measurement range setting	Recommended measurement range	Significant measurement range
10 nF	0 F to 15 nF	0 F to 15 nF
22 nF	15 nF to 33 nF	0 F to 33 nF
47 nF	33 nF to 68 nF	0 F to 68 nF
100 nF	68 nF to 150 nF	0 F to 150 nF
220 nF	150 nF to 330 nF	0 F to 330 nF
470 nF	330 nF to 680 nF	0 F to 680 nF
1 μ F	680 nF to 1.5 μ F	0 F to 1.5 μ F
2.2 μ F	1.5 μ F to 3.3 μ F	0 F to 3.3 μ F
4.7 μ F	3.3 μ F to 6.8 μ F	0 F to 6.8 μ F
10 μ F	6.8 μ F to 15 μ F	0 F to 15 μ F
22 μ F	15 μ F to 33 μ F	0 F to 33 μ F
47 μ F	33 μ F to 68 μ F	0 F to 68 μ F
100 μ F	68 μ F to 150 μ F	0 F to 150 μ F
220 μ F	150 μ F to 330 μ F	0 F to 330 μ F
470 μ F	330 μ F to 680 μ F	0 F to 680 μ F
1 mF	680 μ F to 2 mF	0 F to 2 mF

Available measurement ranges (continued)

Table 3. Measurable capacitance ranges when measurement frequency is 1 kHz

Measurement range setting	Recommended measurement range	Significant measurement range
100 pF	0 pF to 150 pF	0 F to 150 pF
220 pF	150 pF to 330 pF	0 F to 330 pF
470 pF	330 pF to 680 pF	0 F to 680 pF
1 nF	680 pF to 1.5 nF	0 F to 1.5 nF
2.2 nF	1.5 nF to 3.3 nF	0 F to 3.3 nF
4.7 nF	3.3 nF to 6.8 nF	0 F to 6.8 nF
10 nF	6.8 nF to 15 nF	0 F to 15 nF
22 nF	15 nF to 33 nF	0 F to 33 nF
47 nF	33 nF to 68 nF	0 F to 68 nF
100 nF	68 nF to 150 nF	0 F to 150 nF
220 nF	150 nF to 330 nF	0 F to 330 nF
470 nF	330 nF to 680 nF	0 F to 680 nF
1 μ F	680 nF to 1.5 μ F	0 F to 1.5 μ F
2.2 μ F	1.5 μ F to 3.3 μ F	0 F to 3.3 μ F
4.7 μ F	3.3 μ F to 6.8 μ F	0 F to 6.8 μ F
10 μ F	6.8 μ F to 15 μ F	0 F to 15 μ F
22 μ F	15 μ F to 33 μ F	0 F to 33 μ F
47 μ F	33 μ F to 68 μ F	0 F to 68 μ F
100 μ F	68 μ F to 200 μ F	0 F to 200 μ F

Available measurement ranges (continued)

Table 4. Measurable capacitance ranges when measurement frequency is 1 MHz, 1 MHz ±1%, 1 MHz ±2%

Measurement range setting	Recommended measurement range	Significant measurement range
1 pF	0 F to 1.5 pF	0 F to 1.5 pF
2.2 pF	1.5 pF to 3.3 pF	0 F to 3.3 pF
4.7 pF	3.3 pF to 6.8 pF	0 F to 6.8 pF
10 pF	6.8 pF to 15 pF	0 F to 15 pF
22 pF	15 pF to 33 pF	0 F to 33 pF
47 pF	33 pF to 68 pF	0 F to 68 pF
100 pF	68 pF to 150 pF	0 F to 150 pF
220 pF	150 pF to 330 pF	0 F to 330 pF
470 pF	330 pF to 680 pF	0 F to 680 pF
1 nF	680 pF to 1.5 nF	0 F to 1.5 nF

Measurement accuracy

The measurement accuracy is defined when all of the following conditions are met:

- Warm-up time: 30 minutes or longer
- Ambient temperature: 18 °C to 28 °C
- Execution of OPEN Correction
- Execution of Cable Correction for 1 MHz measurement
- Measurement cable length: 0 m, 1 m, or 2 m (16048A/B/D)¹
- D (dissipation factor) ≤ 0.5

Accuracy of Cp, Cs, D, G, Rs, Q and Rp

Tables 8 through 13 show the measurement accuracy of Cp, Cs, and D when D ≤ 0.1.

Table 14 shows the formula of the measurement accuracy of G, Rs, Q and Rn when D ≤ 0.1.

When 0.1 < D ≤ 0.5, multiply the accuracy obtained in Tables 8 through 13 by the coefficient in Table 5.

Table 5. Dissipation factor Coefficient

Parameter	Coefficient
Cp, Cs, G, Rs ²	1 + D ²
D	1 + D

Table 6. Formula of the measurement accuracy of G, R_s, Q and R_p

Parameter	Formula
G _e (G accuracy)	$(C_e/100) \times 2 \times \pi \times f \times C_x$
Rs _e (R _s accuracy)	$(C_e/100) / (2 \times \pi \times f \times C_x)$
Q _e (Q accuracy)	$\frac{\pm Q_x^2 \times D_e}{1 \mp Q_x \times D_e}$
Rp _e (Rp accuracy)	$\frac{\pm Rpx^2 \times Ge}{1 \mp Rpx \times Ge}$

C_e: Cp or Cs accuracy [%]

f: Measurement frequency [Hz]

C_x: Measurement value of Cp or Cs [F]

Q_x: Measurement value of Q

Rp_x: Measurement value of Rp [Ω]

D_e: D accuracy [%]

1. The outer conductor resistance of cable requires the following condition.

16048A/B: 62 mΩ or below

16048D: 90 mΩ or below

2. If you select a secondary measurement parameter other than D, calculate D.

Accuracy when ambient temperature exceeds the range of 18 °C to 28 °C (typical)

When the ambient temperature exceeds the range of 18 °C to 28 °C, multiply the accuracy obtained above by the coefficient shown in the table below.

Table 7. Temperature Coefficient

	Coefficient
0 °C ≤ ambient temperature < 8 °C	3
8 °C ≤ ambient temperature < 18 °C	2
18 °C ≤ ambient temperature ≤ 28 °C	1
28 °C ≤ ambient temperature ≤ 38 °C	2
38 °C ≤ ambient temperature ≤ 45 °C	3

Accuracy when an Alternative Current magnetic field is applied

When an alternating current magnetic field is applied to the instrument. Multiply the accuracy obtained in Tables 8 through 13.

$$1+B \times (2+0.5 \times K)$$

B: Magnetic flux density [Gauss]

Cx: Measured value of the capacitance (Cp or Cs),

Cr: A measurement range [F]

Vs: A measurement signal level [V].

In Tables 8 through 13, K is defined as follows:

$$C_x \leq C_r: K = (1/V_s) \times (C_r/C_x)$$

$$C_x > C_r: K = 1/V_s$$

where

Cx is measured value of the capacitance (Cp or Cs),

Cr is a measurement range and

Vs is a measurement signal level [V].

Measurement accuracy (continued)

Table 8. Measurement accuracy of C_p , C_s (measurement frequency: 120 Hz)

Measurement time mode (N)	Cp, Cs [%]				
	1	2	4	6	8
10 nF 22 nF 47 nF 100 nF 220 nF 470 nF 1 μ F 2.2 μ F 4.7 μ F 10 μ F 22 μ F 47 μ F 100 μ F	$0.055 + 0.030 \times K$	$0.055 + 0.022 \times K$	$0.055 + 0.018 \times K$	$0.055 + 0.016 \times K$	$0.055 + 0.015 \times K$
220 μ F 470 μ F 1 mF	$0.4 + 0.060 \times K$	$0.4 + 0.044 \times K$	$0.4 + 0.036 \times K$	$0.4 + 0.032 \times K$	$0.4 + 0.030 \times K$

Table 9. Measurement accuracy of D (measurement frequency: 120 Hz)

Measurement time mode (N)	D				
	1	2	4	6	8
10 nF 22 nF 47 nF 100 nF 220 nF 470 nF 1 μ F 2.2 μ F 4.7 μ F 10 μ F 22 μ F 47 μ F 100 μ F	$0.00035 + 0.00030 \times K$	$0.00035 + 0.00022 \times K$	$0.00035 + 0.00018 \times K$	$0.00035 + 0.00016 \times K$	$0.00035 + 0.00015 \times K$
220 μ F 470 μ F 1 mF	$0.004 + 0.00060 \times K$	$0.004 + 0.00044 \times K$	$0.004 + 0.00036 \times K$	$0.004 + 0.00032 \times K$	$0.004 + 0.00030 \times K$

Measurement accuracy (continued)

Table 10. Measurement accuracy of C_p , C_s (measurement frequency: 1 kHz)

Measurement time mode (N)	C_p, C_s [%]				
	1	2	4	6	8
100 pF	$0.055 + 0.070 \times K$	$0.055 + 0.047 \times K$	$0.055 + 0.036 \times K$	$0.055 + 0.033 \times K$	$0.055 + 0.030 \times K$
220 pF	$0.055 + 0.045 \times K$	$0.055 + 0.032 \times K$	$0.055 + 0.025 \times K$	$0.055 + 0.022 \times K$	$0.055 + 0.020 \times K$
470 pF 1 nF 2.2 nF 4.7 nF 10 nF 22 nF 47 nF 100 nF 220 nF 470 nF 1 μ F 2.2 μ F 4.7 μ F 10 μ F	$0.055 + 0.030 \times K$	$0.055 + 0.022 \times K$	$0.055 + 0.018 \times K$	$0.055 + 0.016 \times K$	$0.055 + 0.015 \times K$
22 μ F 47 μ F 100 μ F	$0.4 + 0.060 \times K$	$0.4 + 0.044 \times K$	$0.4 + 0.036 \times K$	$0.4 + 0.032 \times K$	$0.4 + 0.030 \times K$

Table 11. Measurement accuracy of D (measurement frequency: 1 kHz)

Measurement time mode (N)	D				
	1	2	4	6	8
100 pF	$0.00035 + 0.00070 \times K$	$0.00035 + 0.00047 \times K$	$0.00035 + 0.00036 \times K$	$0.00035 + 0.00033 \times K$	$0.00035 + 0.00030 \times K$
220 pF	$0.00035 + 0.00045 \times K$	$0.00035 + 0.00032 \times K$	$0.00035 + 0.00025 \times K$	$0.00035 + 0.00022 \times K$	$0.00035 + 0.00020 \times K$
470 pF 1 nF 2.2 nF 4.7 nF 10 nF 22 nF 47 nF 100 nF 220 nF 470 nF 1 μ F 2.2 μ F 4.7 μ F 10 μ F	$0.00035 + 0.00030 \times K$	$0.00035 + 0.00022 \times K$	$0.00035 + 0.00018 \times K$	$0.00035 + 0.00016 \times K$	$0.00035 + 0.00015 \times K$
22 μ F 47 μ F 100 μ F	$0.004 + 0.00060 \times K$	$0.004 + 0.00044 \times K$	$0.004 + 0.00036 \times K$	$0.004 + 0.00032 \times K$	$0.004 + 0.00030 \times K$

Measurement accuracy (continued)

Table 12. Measurement accuracy of C_p, C_s (measurement frequency: 1 MHz, 1 MHz \pm 1%, 1 MHz \pm 2%)

C_p, C_s [%]					
Measurement time mode (N)	1	2	4	6	8
1 pF	$0.055 + 0.070 \times K$	$0.055 + 0.047 \times K$	$0.055 + 0.036 \times K$	$0.055 + 0.033 \times K$	$0.055 + 0.030 \times K$
2.2 pF	$0.055 + 0.045 \times K$	$0.055 + 0.032 \times K$	$0.055 + 0.025 \times K$	$0.055 + 0.022 \times K$	$0.055 + 0.020 \times K$
4.7 pF 10 pF 22 pF 47 pF 100 pF 220 pF 470 pF 1 nF	$0.055 + 0.030 \times K$	$0.055 + 0.022 \times K$	$0.055 + 0.018 \times K$	$0.055 + 0.016 \times K$	$0.055 + 0.015 \times K$

Table 13. Measurement accuracy of D (measurement frequency: 1 MHz, 1 MHz \pm 1%, 1 MHz \pm 2%)

D					
Measurement time mode (N)	1	2	4	6	8
1 pF	$0.00035 + 0.00070 \times K$	$0.00035 + 0.00047 \times K$	$0.00035 + 0.00036 \times K$	$0.00035 + 0.00033 \times K$	$0.00035 + 0.00030 \times K$
2.2 pF	$0.00035 + 0.00045 \times K$	$0.00035 + 0.00032 \times K$	$0.00035 + 0.00025 \times K$	$0.00035 + 0.00022 \times K$	$0.00035 + 0.00020 \times K$
4.7 pF 10 pF 22 pF 47 pF 100 pF 220 pF 470 pF 1 nF	$0.00035 + 0.00030 \times K$	$0.00035 + 0.00022 \times K$	$0.00035 + 0.00018 \times K$	$0.00035 + 0.00016 \times K$	$0.00035 + 0.00015 \times K$

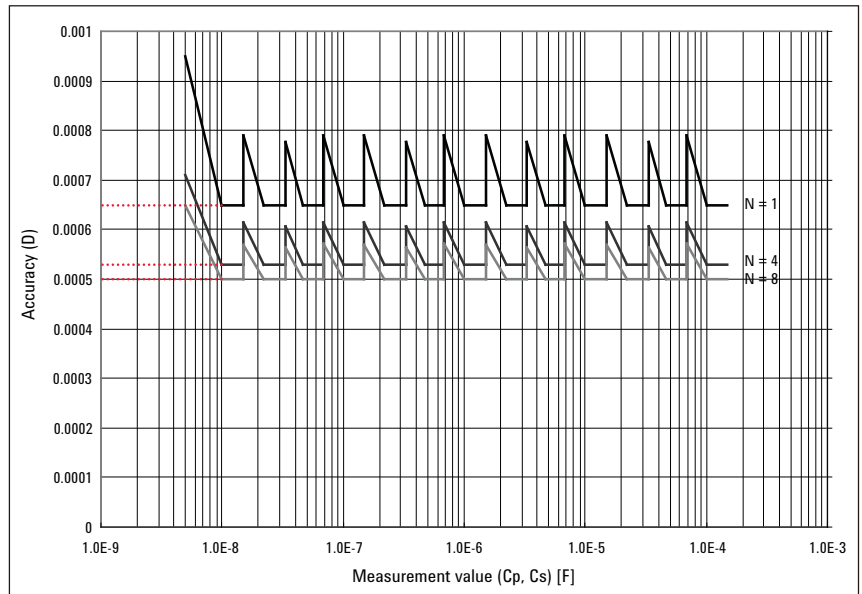

Figure 1. Accuracy of D when measurement frequency is 120 Hz
(measurement range: 10 nF to 100 μ F / measurement signal level: 0.5 V)

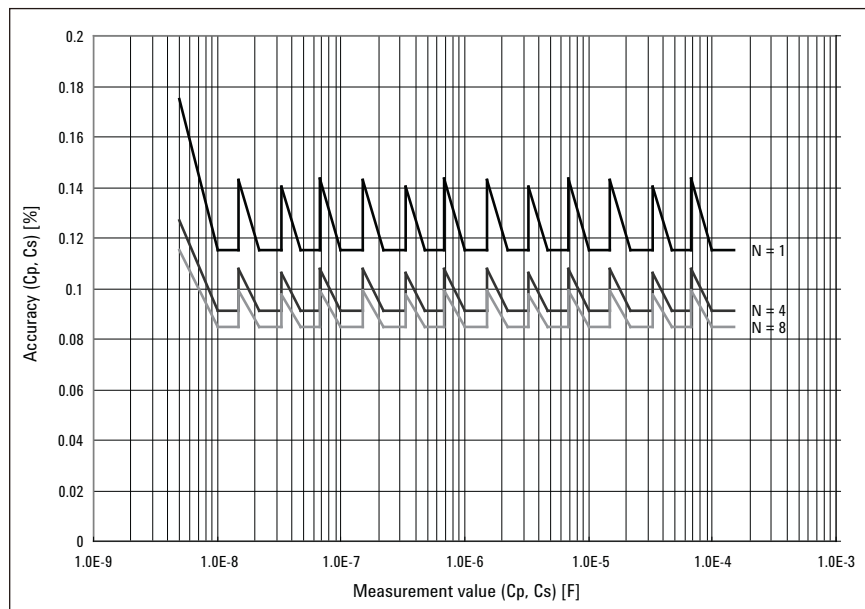

Figure 2. Accuracy of Cp and Cs when measurement frequency is 120 Hz
(measurement range: 10 nF to 100 μ F / measurement signal level: 0.5 V)

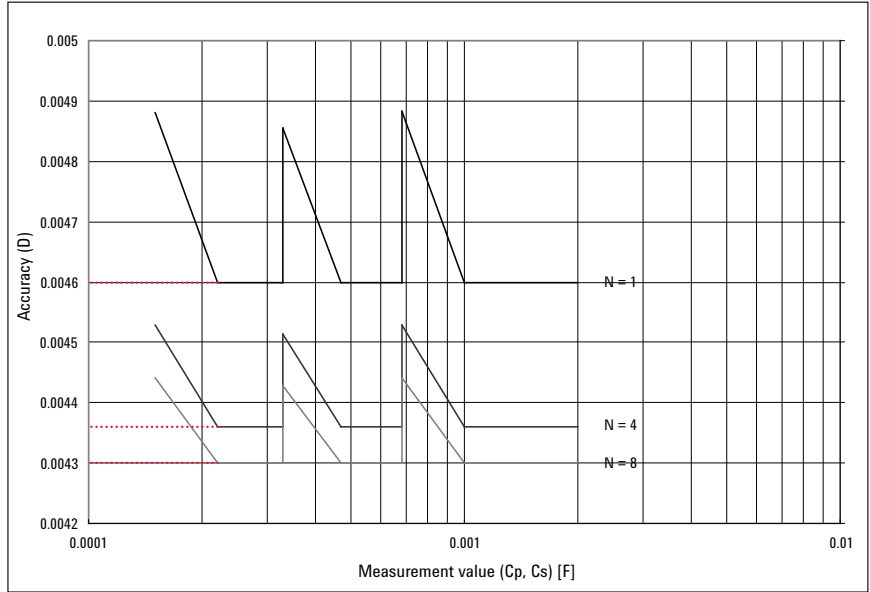

Figure 3. Accuracy of D when measurement frequency is 120 Hz (measurement range: 220 μ F to 1 mF / measurement signal level: 1 V)

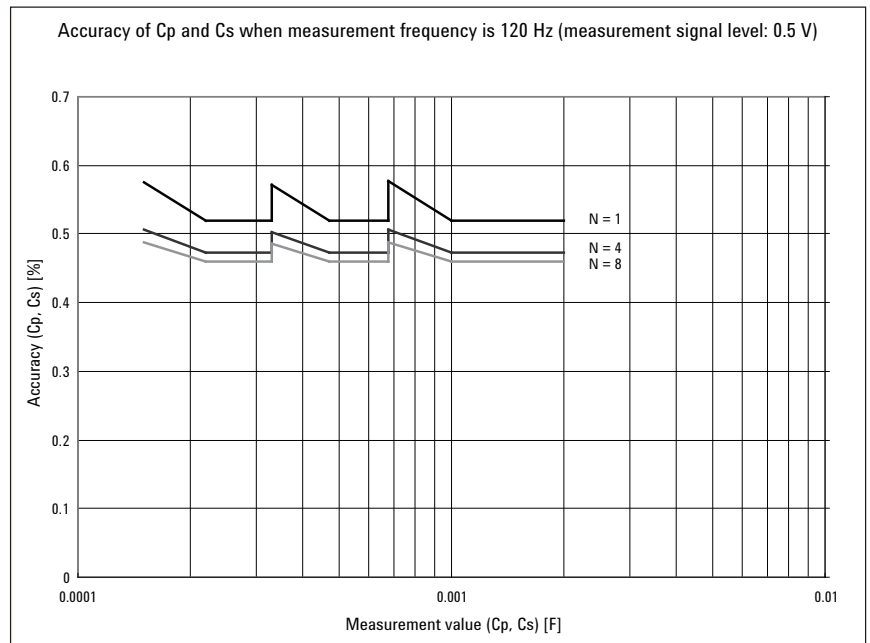

Figure 4. Accuracy of Cp and Cs when measurement frequency is 120 Hz (measurement range: 220 μ F to 1 mF / measurement signal level: 1 V)

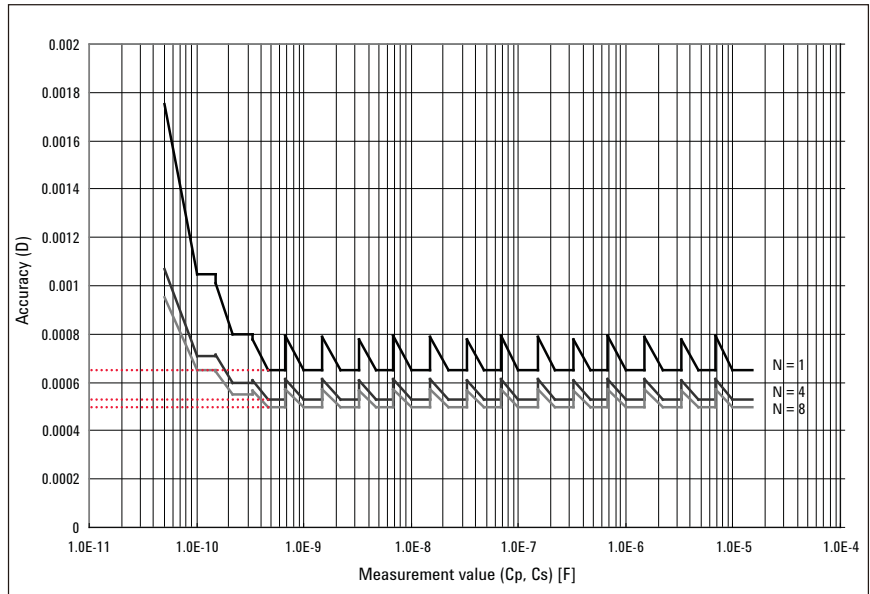

Figure 5. Accuracy of D when measurement frequency is 1 kHz
(measurement range: 100 pF to 10 μ F / measurement signal level: 1 V)

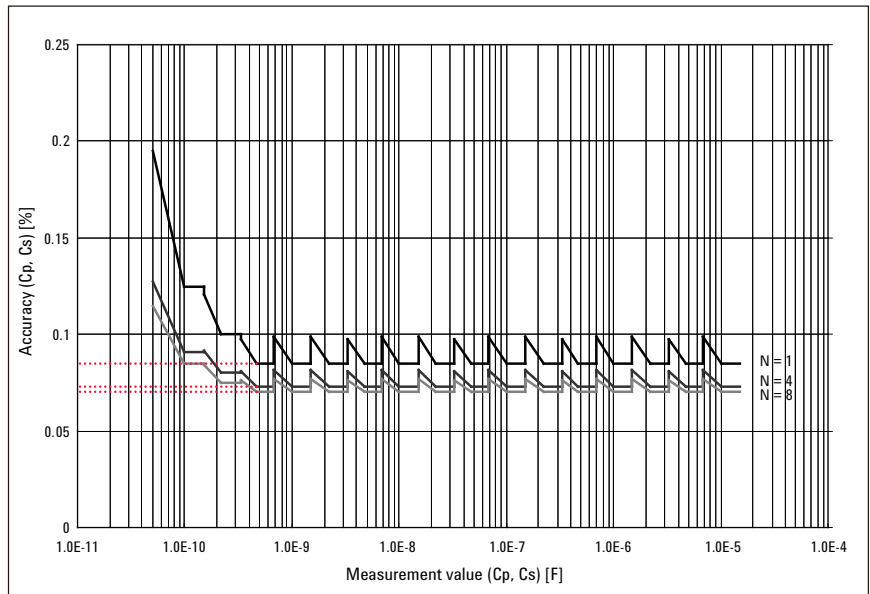

Figure 6. Accuracy of Cp and Cs when measurement frequency is 1 kHz
(measurement range: 100 pF to 10 μ F / measurement signal level: 1 V)

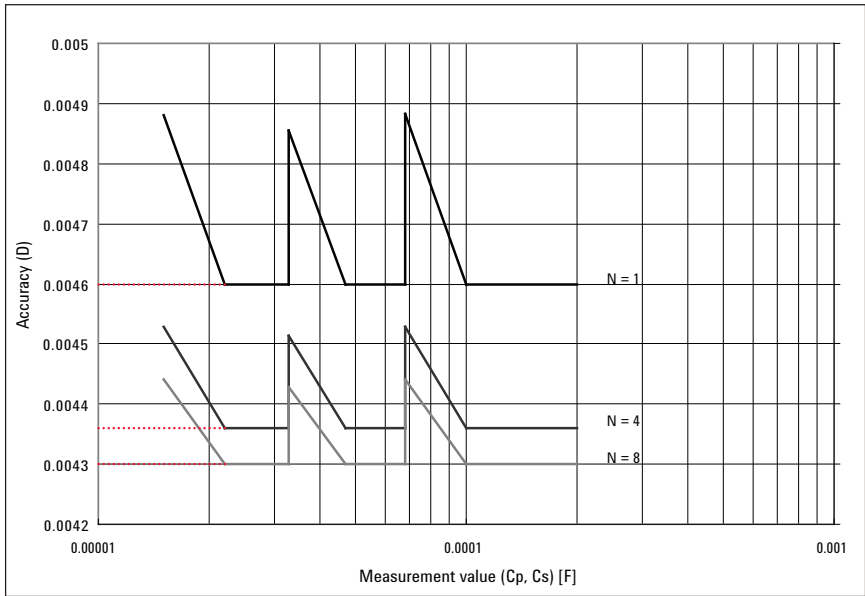

Figure 7. Accuracy of D when measurement frequency is 1 kHz
(measurement range: 22 μ F to 100 μ F / measurement signal level: 1 V)

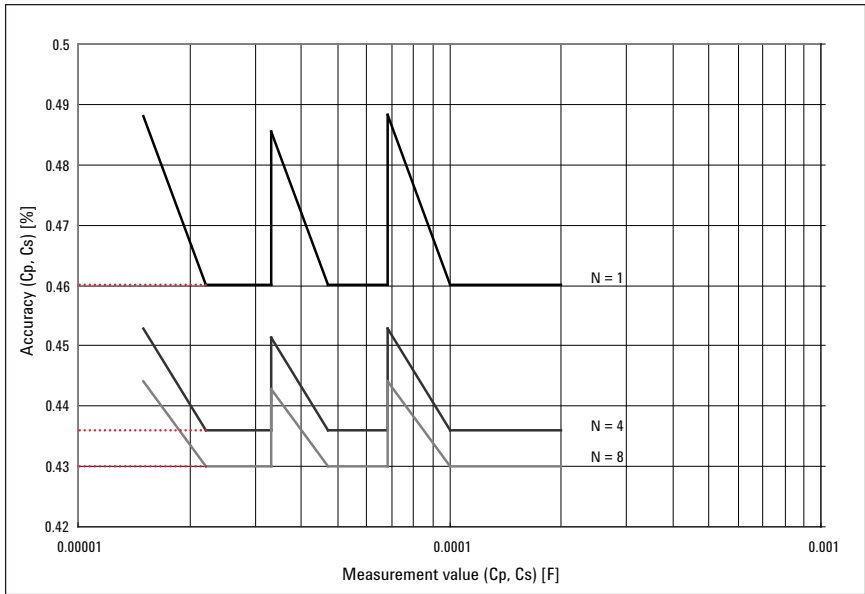

Figure 8. Accuracy of Cp and Cs when measurement frequency is 1 kHz
(measurement range: 22 μ F to 100 μ F / measurement signal level: 1 V)

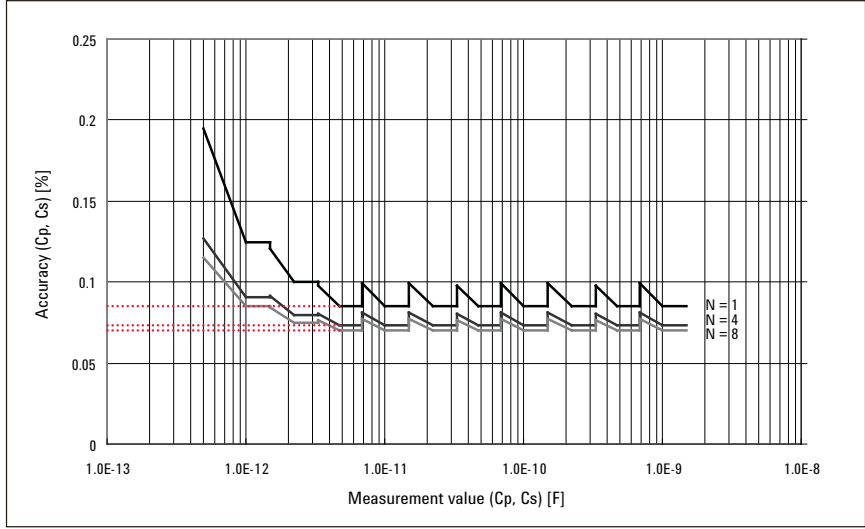

Figure 9. Accuracy of Cp and Cs when measurement frequency is 1 MHz (measurement signal level: 1 V)

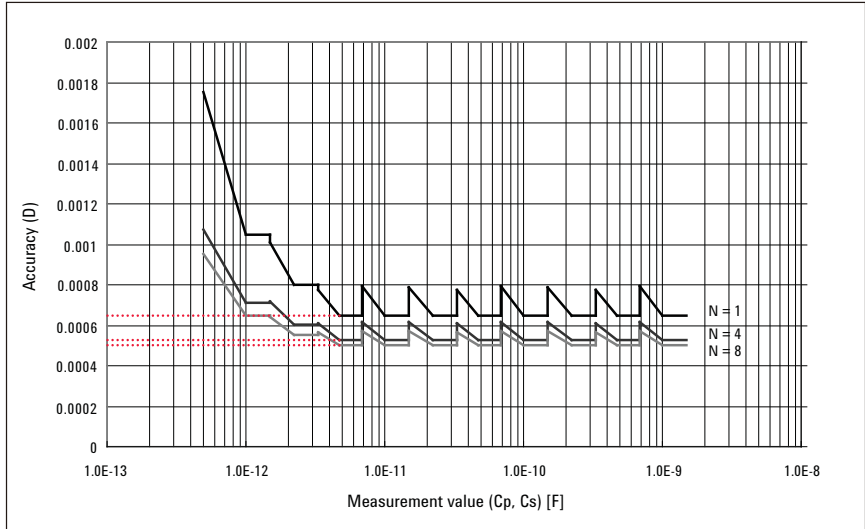

Figure 10. Accuracy of D when measurement frequency is 1 MHz (measurement signal level: 1 V)

Sample calculation of measurement accuracy is described on page 31.

Supplemental Information

Measurement signals

	SLC OFF ($\geq 220 \mu\text{F}$ range)	1.5 Ω (nom.) ¹
Frequency: 120 Hz	SLC ON ($\geq 220 \mu\text{F}$ range)	0.3 Ω (nom.) ¹
	2.2 μF to 100 μF range	0.3 Ω (nom.) ¹
	10 nF to 1 μF range	20 Ω (nom.) ¹
Output impedance	SLC OFF ($\geq 22 \mu\text{F}$ range)	1.5 Ω (nom.) ¹
Frequency: 1 kHz	SLC ON ($\geq 22 \mu\text{F}$ range)	0.5 Ω (nom.) ¹
	220 nF to 10 μF range	0.3 Ω (nom.) ¹
	100 pF to 100 nF range	20 Ω (nom.) ¹
Frequency: 1 MHz / 1 MHz \pm 2% / 1 MHz \pm 1%		20 Ω (nom.) ¹

Measurement time

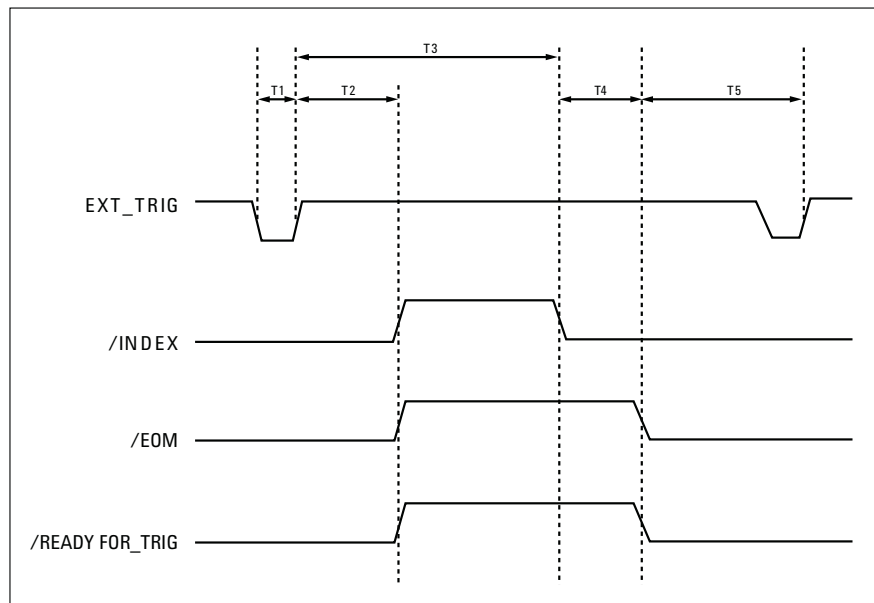

Figure 11. Timing chart and measurement time

1. This value is defined without an extension cable.

Table 14 shows the values of T1 – T5 when the following conditions are met:

- Display update: Off
- Synchronous source: On
- Measurement range mode: Hold range mode (Hold)
- Source delay time: 0 ms
- Trigger delay time: 0 ms
- Averaging factor: 1
- SLC: Off
- Measurement time mode (N): 1
- Correction: On
- Multi connection: On
- LAN: Not connected

Table 14. Values of T1 – T5 (typical)

		Measurement frequency	Minimum value	Typical value
T1				
Trigger pulse width		N/A	1 μ s	–
T2				
Trigger response time of /READY_FOR_TRIG, /INDEX and /EOM		N/A	–	40 μ s
(T3 + T4)	T3			
Measurement time	Analog	120 Hz	–	10.0 ms
	measurement	1 kHz	–	2.0 ms
	time	1 MHz	–	1.3 ms
(T3 + T4)	T4			
Measurement time	Measurement computation time	N/A	–	1.0 ms
T5				
Trigger wait time		N/A	0 μ Sec	–

Display time

Except in the case of the DISPLAY BLANK page, the time required to update the display on each page (display time) is as follows (Table 15). When the screen is changed, drawing time and switching time are added. The measurement display is updated about every 100 ms.

Table 15. Display time

Item	Time
MEAS DISPLAY page drawing time	10 ms
MEAS DISPLAY page (large) drawing time	10 ms
BIN No. DISPLAY page drawing time	10 ms
BIN COUNT DISPLAY page drawing time	10 ms
Measurement display switching time	35 ms

Table 16 shows the measurement time (T3 + T4) for each measurement time mode.

Measurement time

Table 16. Measurement time

Frequency	Measurement time [ms]
120 Hz	$(N \times 8.3 \times Ave + 2.7) \pm 0.5$
1 kHz	$(N \times 1.0 \times Ave + 2.0) \pm 0.5$
1 MHz / 1 MHz \pm 1% / 1 MHz \pm 2%	$(N \times 1.0 \times (100 / (100 + Fshift)) \times Ave + 1.3) \pm 0.5$

Measurement time mode (N) = 1, 2, 4, 6, 8

Ave: Averaging factor

Fshift: Frequency shift setting

Measurement data transfer time

Table 17 shows the measurement data transfer time under the following conditions. The measurement transfer time varies with the measurement conditions and computer used.

- Host computer: DELL PRECISION 390, 1.86 GHz/Windows XP
- USB GPIB Interface Card: 82350A
- USB GPIB Interface: E2078A
- Display: ON
- Measurement range mode: Hold range mode (Hold)
- OPEN/SHORT/LOAD correction: OFF
- Measurement signal monitor: OFF
- BIN count function: OFF

Table 17. Measurement data transfer time (typical)

Interface	Data transfer format	using :FETC? command (one point measurement)		using :READ command (one point measurement)		using data buffer memory (1000 measurement points (BUFFER3))	
		Comparator ON [ms]	Comparator OFF [ms]	Comparator ON [ms]	Comparator OFF [ms]	Comparator ON [ms]	Comparator OFF [ms]
GPIB	ASCII	1	1	3	3	202	186
	ASCII Long	1	1	3	3	247	231
	Binary	1	1	3	4	145	111
USB	ASCII	1	1	4	4	101	94
	ASCII Long	1	1	4	4	121	114
	Binary	1	1	4	4	43	33
LAN	ASCII	3	3	5	5	158	146
	ASCII Long	3	3	6	6	193	181
	Binary	5	5	7	7	105	79

Measurement Assistance Functions

Measurement assistance functions

Correction function	<ul style="list-style-type: none"> – OPEN/SHORT/LOAD Correction are available – The OFFSET Correction is available
MULTI Correction function	<ul style="list-style-type: none"> – OPEN/SHORT/LOAD Correction for 256 channels – The LOAD Correction standard value can be defined for each channel
Cable Correction function	Cable Correction is available
Deviation measurement function	Deviation from reference value and percentage of deviation from the reference value can be outputted as the result
Comparator function	<ul style="list-style-type: none"> – BIN sort: The primary parameter can be sorted into 9 BINS, OUT_OF_BINS, AUX_BIN, and LOWC_OR_NC. The secondary parameter can be sorted into High, In, and Low. – Limit setup: An absolute value, deviation value, and % deviation value can be used for setup – Bin count: Countable from 0 to 999999
Low C reject function	Extremely low measured capacitance values can be automatically detected as measurement errors
Contact check function	The contact check function is available on 120 Hz and 1 kHz
Single Level Compensation	<ul style="list-style-type: none"> – SLC function compensates the voltage drop by the resistance inside the E4981A and the extension cable under the following frequencies and ranges – Measurement cable: 16048A or 16048D – When the measurement frequency is 120 Hz: 220 μF range, 470 μF range, 1 mF range – When the measurement frequency is 1 kHz: 22 μF range, 47 μF range, 100 μF range

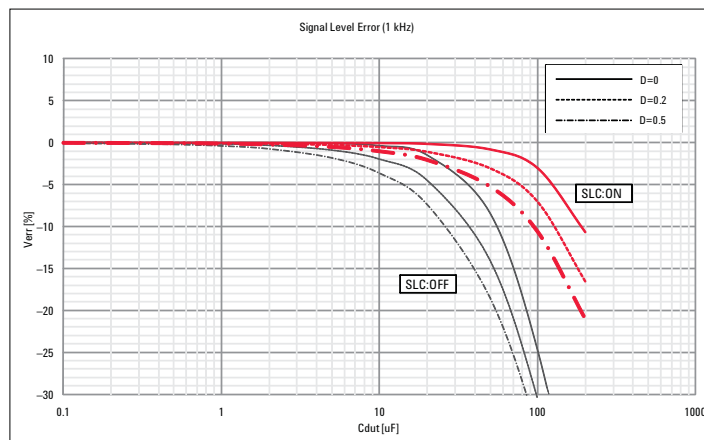
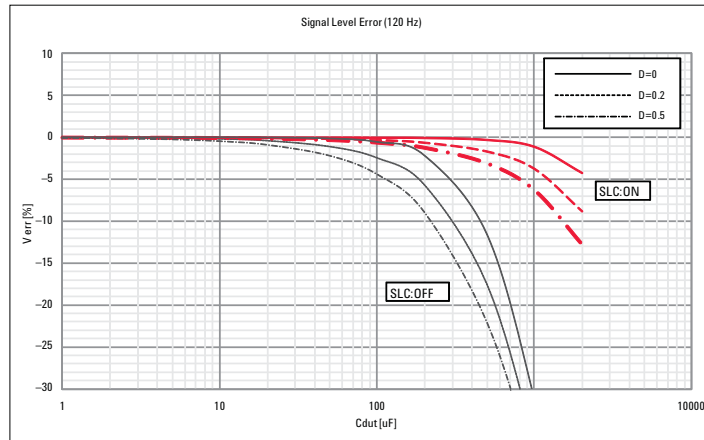

Measurement assistance functions

Measurement signal level monitor function	<ul style="list-style-type: none"> – Measurement voltage and measurement current can be monitored – Level monitor accuracy (typical): $\pm (3\% + 1 \text{ mV})$
Data buffer function	Up to 1000 measurement results can be read out in batch
Save/recall function	<ul style="list-style-type: none"> – Up to 10 setup conditions can be written to/read from the built-in nonvolatile memory – Up to 10 setup conditions can be written to/read from the external USB memory – Auto recall function can be performed when the setting conditions are written to Register 9 in the built-in non-volatile memory
Key lock function	The front panel keys can be locked
GPIB interface	Complies with IEEE488.1, 2 and SCPI
USB host port	<p>Universal serial bus jack, type-A (4 contact positions, contact 1 is on your left); female; for connection to USB memory device only</p> <p>Note: The following USB memory can be used.</p> <ul style="list-style-type: none"> – Complies with USB 1.1; mass storage class, FAT16/FAT32 format; maximum consumption current is below 500 mA – Recommended USB memory: 4 GB USB Flash memory (Keysight PN 1819-0637) – Use the prepared USB memory device exclusively for the E4981A; otherwise, other previously saved data may be cleared. If you use a USB memory other than the recommended device, data may not be saved or recalled normally. – Keysight will NOT be responsible for data loss in the USB memory caused by using the E4981A
USB interface port	<ul style="list-style-type: none"> – Universal serial bus jack, type mini-B (4 contact positions); complies with USBTMC-USB488 and USB 2.0; female; for connection to the external controller. – USBTMC: Abbreviation for USB Test & Measurement Class
LAN interface	<ul style="list-style-type: none"> – 10/100 BaseT Ethernet, 8 pins; two speed options – Compliant with LXI standard (LAN eXtensions for Instrumentation): Version 1.2, Class C – Auto MDIX
Handler interface	<p>The input/output signals are negative logic and optically isolated open collector signals</p> <ul style="list-style-type: none"> – Output signal: Bin1–Bin9, Out of Bins, Aux Bin, P-Hi, P-Lo, S-Reject, INDEX, EOM, Alarm, OVLD, Low C Reject or No Contact, Ready_For_Trigger – Input signal: Keylock, Ext-Trigger
Scanner interface	<p>The input/output signals are negative logic and optically isolated open collector signals</p> <ul style="list-style-type: none"> – Output signal: INDEX, EOM – Input signal: Ch0 – Ch7, Ch valid, Ext-Trigger
Measurement circuit protection	<p>The maximum discharge withstand voltage, where the internal circuit remains protected if a charged capacitor is connected to the UNKNOWN terminal, is illustrated below.</p> <p>NOTE: Discharge capacitors before connecting them to the UNKNOWN terminal or a test fixture.</p>

Table 18. Maximum discharge withstand voltage (typical)

Maximum discharge withstand voltage	Range of capacitance value C of DUT
1000 V	$C < 2 \mu\text{F}$
$\sqrt{2/C}$ V	$C \geq 2 \mu\text{F}$

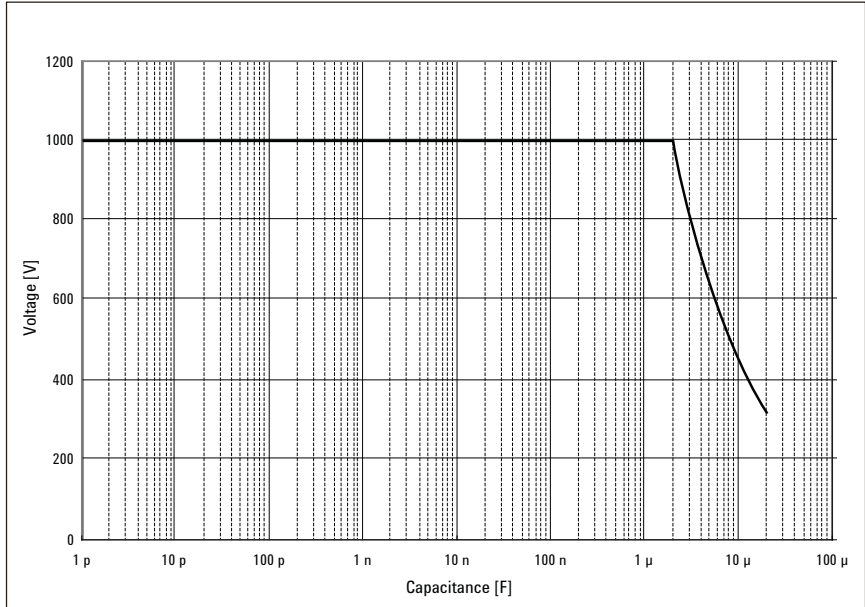

Figure 13. Maximum discharge withstand voltage (typical)

General Specifications

Power source	
Voltage	90 VAC to 264 VAC
Frequency	47 Hz to 63 Hz
Power consumption	Maximum 150 VA

Operating environment	
Temperature	0 °C to 45 °C
Humidity (≤ 40 °C, no condensation)	15% to 85% RH
Altitude	0 m to 2000 m

Storage environment	
Temperature	−20 °C to 70 °C
Humidity (≤ 65 °C, no condensation)	0% to 90% RH
Altitude	0 m to 4572 m

Other	
Weight	4.3 kg (nominal)
Display	LCD, 320 x 240 (pixel), RGB color
Outer dimensions	370 (width) x 105 (height) x 405 (depth) mm (nominal)

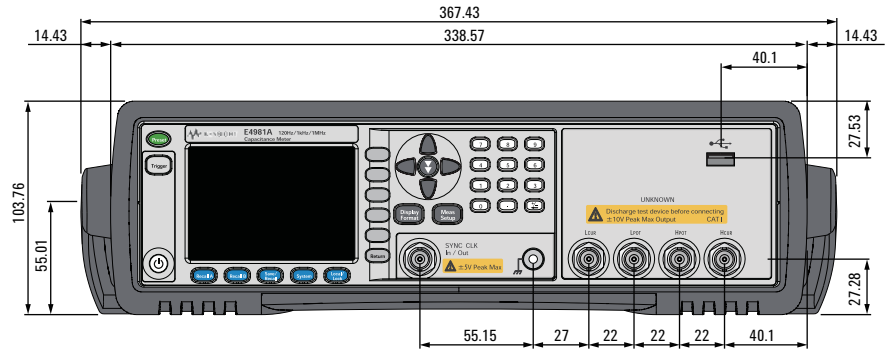

Figure 14. Dimensions (front view, with handle and bumper, in millimeters, nominal)

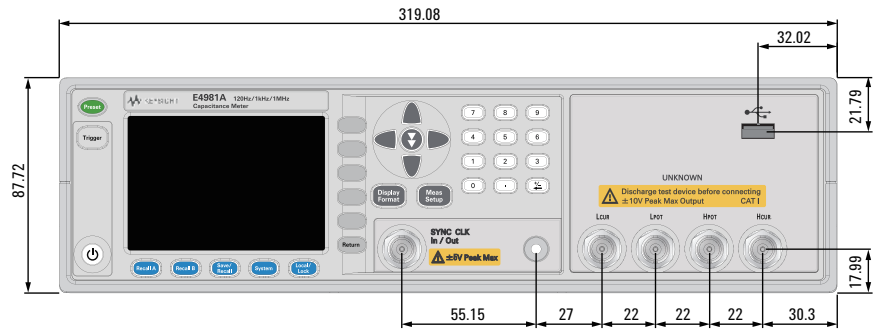

Figure 15. Dimensions (front view, without handle and bumper, in millimeters, nominal)

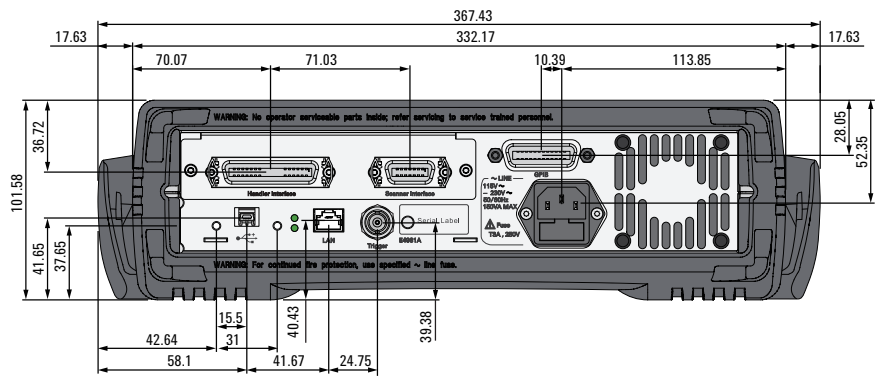

Figure 16. Dimensions (rear view, with handle and bumper, in millimeters, nominal)

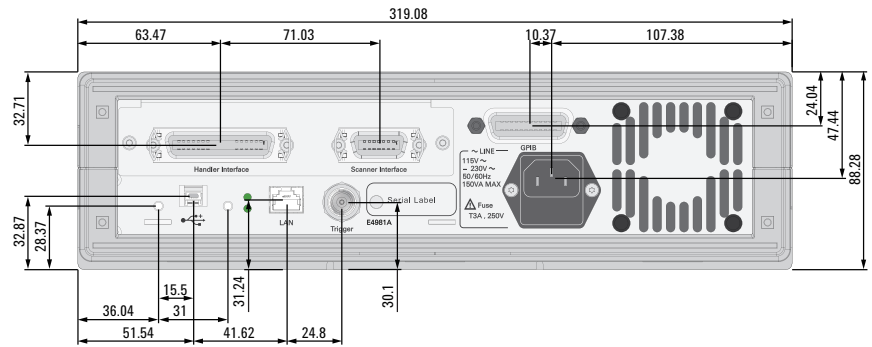

Figure 17. Dimensions (rear view, without handle and bumper, in millimeters, nominal)

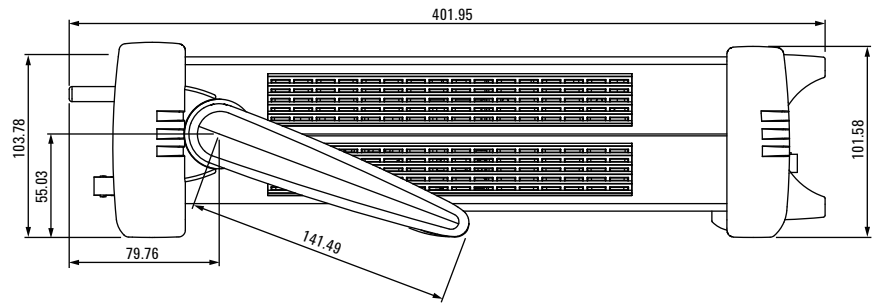

Figure 18. Dimensions (side view, with handle and bumper, in millimeters, nominal)

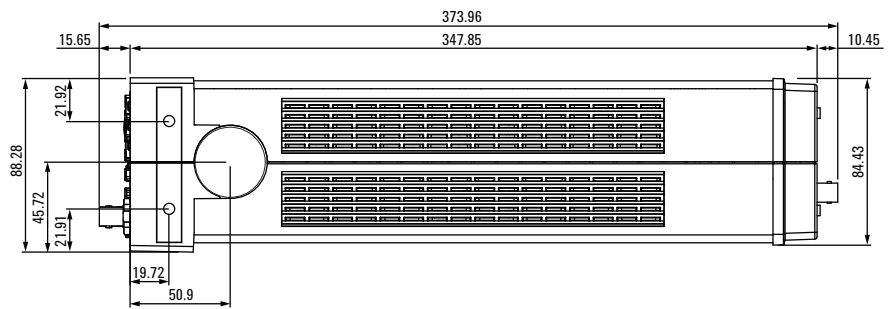

Figure 19. Dimensions (side view, without handle and bumper, in millimeters, nominal)

EMC

European Council Directive
2004/108/EC

IEC 61326-1:1997 +A1:1998 +A2:2000
EN 61326-1:1997 +A1:1998 +A2:2001

CISPR 11:1997 +A1:1999 +A2:2002
EN 55011:1998 +A1:1999 +A2:2002

Group 1, Class A

IEC 61000-4-2:1995 +A1:1998 +A2:2001
EN 61000-4-2:1995 +A1:1998 +A2:2001

4 kV CD / 8 kV AD

IEC 61000-4-3:1995 +A1:1998 +A2:2001
EN 61000-4-3:1996 +A1:1998 +A2:2001

3 V/m, 80-1000 MHz, 80% AM

IEC 61000-4-4:1995 +A1:2001 +A2:2001
EN 61000-4-4:1995 +A1:2001 +A2:2001

1 kV power / 0.5 kV Signal

IEC 61000-4-5:1995 +A1:2001
EN 61000-4-5:1995 +A1:2001

0.5 kV Normal / 1 kV Common

IEC 61000-4-6:1996 +A1:2001
EN 61000-4-6:1996 +A1:2001

3 V, 0.15-80 MHz, 80% AM

IEC 61000-4-11:1994 +A1:2001
EN 61000-4-11:1994 +A1:2001

100% 1cycle

ICES/NMB-001

This ISM device complies with Canadian ICES-001:1998.
Cet appareil ISM est conforme à la norme NMB-001 du Canada.



N10149

AS/NZS 2064.1

Group 1, Class A

Safety

European Council Directive
73/23/EEC, 93/68/EEC

IEC 61010-1:2001
EN 61010-1:2001

Measurement Category I
Pollution Degree 2
Indoor Use

IEC60825-1:1994

Class 1 LED



LR95111C

CAN/CSA C22.2 61010-1-04

Measurement Category I
Pollution Degree 2
Indoor Use

WEEE

European Council Directive
2002/96/EC

Sample Calculation of Measurement Accuracy

This section describes an example for calculating the measurement accuracy of each measurement parameter, assuming the following measurement conditions

Sample

- Measurement signal frequency: 1 kHz
- Measurement signal level: 0.5 V
- Measurement range: 10 nF
- Measurement time mode: N = 1
- Ambient temperature: 28 °C

When measurement parameter is Cp-D (or Cs-D)

The following is an example for calculating the accuracy of Cp (or Cs) and D, assuming that measured result of Cp (or Cs) is 8.00000 nF and measured result of D is 0.01000.

From Table 7, the equation to calculate the accuracy of Cp (or Cs) is

$$0.055 + 0.030 \times K$$

and the equation to calculate the accuracy of D is

$$0.00035 + 0.00030 \times K$$

The measurement signal level is 0.5, the measurement range is 10 nF, and the measured result of Cp (or Cs) is 8.00000 nF. Therefore,

$$K = (1/0.5) \times (10/8.00000) = 2.5$$

Substitute this result into the equation. As a result, the accuracy of Cp (or Cs) is

$$0.055 + 0.030 \times 2.5 = 0.13\%$$

and the accuracy of D is

$$0.00035 + 0.00030 \times 2.5 = 0.0011$$

Therefore, the true Cp (or Cs) value exists within

$$8.00000 \pm (8.00000 \times 0.13/100) = 8.00000 \pm 0.0104 \text{ nF}$$

that is,

$$7.9896 \text{ nF to } 8.0104 \text{ nF}$$

and the true D value exists within

$$0.01000 \pm 0.0011$$

that is,

$$0.0089 \text{ to } 0.0111$$

When measurement parameter is Cp-Q (or Cs-Q)

The following is an example for calculating the accuracy of Cp (or Cs) and Q, assuming that measured result of Cp (or Cs) is 8.00000 nF and measured result of Q is 20.0.

The accuracy of Cp (or Cs) is the same as that in the example of Cp-D.

From Table 8, the equation to calculate the accuracy of D is

$$0.00035 + 0.00030 \times K$$

Substitute $K = 2.5$ (same as Cp-D) into this equation.

The accuracy of D is

$$0.00035 + 0.00030 \times 2.5 = 0.0011$$

Then, substitute the obtained D accuracy into Equation 1. The accuracy of Q is

$$\pm(20.0)^2 \times 0.0011 / (1 \mp 20.0 \times 0.0011) = \pm 0.44 / (1 \mp 0.022)$$

that is,

$$-0.43 \text{ to } 0.45$$

Therefore, the true Q value exists within the range of

$$19.57 \text{ to } 20.45$$

When measurement parameter is Cp-G

The following is an example for calculating the accuracy of Cp and G, assuming that measured result of Cp is 8.00000 nF and measured result of G is 1.00000 μ S.

The accuracy of Cp is the same as that in the example of Cp-D.

From Table 11, the equation to calculate the accuracy of G is

$$(3.5 + 2.0 \times K) \times C_x$$

Substitute $K = 2.5$ (same as Cp-D) and 8.00000 nF of the measured Cp result into this equation.

The accuracy of G is

$$(3.5 + 2.0 \times 2.5) \times 8.00000 = 68 \text{ nS} (0.068 \mu\text{S})$$

Therefore, the true G value exists within

$$1.00000 \pm 0.068 \mu\text{S}$$

that is,

$$0.932 \mu\text{S} \text{ to } 1.068 \mu\text{S}$$

When measurement parameter is Cp-Rp

The following is an example for calculating the accuracy of Cp and Rp, assuming that measured result of Cp is 8.00000 nF and measured result of Rp is 2.00000 MΩ.

The accuracy of Cp is the same as that in the example of Cp-D.

From Table 11 the equation to calculate the accuracy of G is

$$(3.5 + 2.0 \times K) \times C_x$$

Substitute K = 2.5 (same as Cp-D) and 8.00000 nF of the measured Cp result into this equation.

The accuracy of G is

$$(3.5 + 2.0 \times 2.5) \times 8.00000 = 68 \text{ nS}$$

Then, substitute the obtained G accuracy into Equation 2. The accuracy of Rp is

$$\pm (2 \times 10^6)^2 \times 68 \times 10^{-9} / (1 \mp 2 \times 10^6 \times 68 \times 10^{-9}) = \pm 0.272 \times 10^6 / (1 \mp 0.136)$$

that is,

$$-0.23944 \text{ M}\Omega \text{ to } 0.31481 \text{ M}\Omega$$

Therefore, the true Rp value exists within

$$1.76056 \text{ M}\Omega \text{ to } 2.31481 \text{ M}\Omega$$

When measurement parameter is Cs-Rs

The following is an example for calculating the accuracy of Cp and Rs, assuming that measured result of Cs is 8.00000 nF and measured result of Rs is 4.00000 kΩ.

Because the Cs accuracy is

$$D = 2 \times \pi \times \text{Freq} \times C_s \times R_p = 2 \times \pi \times 10^3 \times 8 \times 10^{-9} \times 4 \times 10^3 = 0.2 > 0.1$$

multiply 0.13% (the result obtained for Cs-D) by 1 + D2.

The result is

$$0.13 \times (1 + 0.22) = 0.1352\%$$

From Table 11 the equation to calculate the accuracy of Rs is

$$(90 + 50 \times K)/C_x$$

Substitute K = 2.5 (same as Cs-D) and 8.00000 nF of the measured Cs result into this equation.

The accuracy of G is

$$(90 + 50 \times 2.5)/8.00000 = 26.875 \Omega$$

Because D > 0.1, multiply the result by 1 + D2 as in the case of Cs. The final result is 27.95 Ω.

Therefore, the true Cs value exists within

$$8.00000 \pm (8.00000 \times 0.1352/100) = 8.00000 \pm 0.01082 \text{ nF}$$

that is,

$$7.98918 \text{ nF to } 8.01082 \text{ nF}$$

and the true Rs value exists within

$$4.00000 \pm 0.02795 \text{ k}\Omega$$

that is,

$$3.97205 \text{ to } 4.02795 \text{ k}\Omega$$

myKeysight

myKeysight

www.keysight.com/find/mykeysight

A personalized view into the information most relevant to you.



www.axiestandard.org

AdvancedTCA® Extensions for Instrumentation and Test (AXIe) is an open standard that extends the AdvancedTCA for general purpose and semiconductor test. Keysight is a founding member of the AXIe consortium. ATCA®, AdvancedTCA®, and the ATCA logo are registered US trademarks of the PCI Industrial Computer Manufacturers Group.



www.lxistandard.org

LAN eXtensions for Instruments puts the power of Ethernet and the Web inside your test systems. Keysight is a founding member of the LXI consortium.



www.pxisa.org

PCI eXtensions for Instrumentation (PXI) modular instrumentation delivers a rugged, PC-based high-performance measurement and automation system.



Three-Year Warranty

www.keysight.com/find/ThreeYearWarranty

Keysight's commitment to superior product quality and lower total cost of ownership. The only test and measurement company with three-year warranty standard on all instruments, worldwide.



Keysight Assurance Plans

www.keysight.com/find/AssurancePlans

Up to five years of protection and no budgetary surprises to ensure your instruments are operating to specification so you can rely on accurate measurements.



www.keysight.com/quality

Keysight Technologies, Inc.
DEKRA Certified ISO 9001:2008
Quality Management System

Keysight Channel Partners

www.keysight.com/find/channelpartners

Get the best of both worlds: Keysight's measurement expertise and product breadth, combined with channel partner convenience.

For more information on Keysight Technologies' products, applications or services, please contact your local Keysight office. The complete list is available at: www.keysight.com/find/contactus

Americas

Canada	(877) 894 4414
Brazil	55 11 3351 7010
Mexico	001 800 254 2440
United States	(800) 829 4444

Asia Pacific

Australia	1 800 629 485
China	800 810 0189
Hong Kong	800 938 693
India	1 800 112 929
Japan	0120 (421) 345
Korea	080 769 0800
Malaysia	1 800 888 848
Singapore	1 800 375 8100
Taiwan	0800 047 866
Other AP Countries	(65) 6375 8100

Europe & Middle East

Austria	0800 001122
Belgium	0800 58580
Finland	0800 523252
France	0805 980333
Germany	0800 6270999
Ireland	1800 832700
Israel	1 809 343051
Italy	800 599100
Luxembourg	+32 800 58580
Netherlands	0800 0233200
Russia	8800 5009286
Spain	0800 000154
Sweden	0200 882255
Switzerland	0800 805353
	Opt. 1 (DE)
	Opt. 2 (FR)
	Opt. 3 (IT)
United Kingdom	0800 0260637

For other unlisted countries:
www.keysight.com/find/contactus
(BP-07-10-14)