

PLEASE CHECK WWW.MOLEX.COM FOR LATEST PART INFORMATION

Part Number: [43045-1600](#)

Status: **Active**

Overview: Micro-Fit 3.0™ Connectors

Description: Micro-Fit 3.0™ Header, Surface Mount Compatible, Dual Row, Right Angle, with Snap-in Plastic Peg PCB Lock, 16 Circuits, Tin (Sn) Plating, Glow Wire Compatible

Documents:

[3D Model](#)

[Drawing \(PDF\)](#)

[Product Specification PS-43045 \(PDF\)](#)

[Test Summary TS-43045-001 \(PDF\)](#)

[RoHS Certificate of Compliance \(PDF\)](#)

[Product Literature \(PDF\)](#)

Agency Certification

CSA	LR19980
TUV	R72081037
UL	E29179

General

Product Family	PCB Headers
Series	43045
Application	Power, Wire-to-Board
Comments	"High Temperature Square Pin Solder Type<P><P>This Molex product is manufactured from material that has the following ratings, tested by independent agencies: a) A Glow Wire Ignition Temperature (GWIT) of at least 775 deg C per IEC 60695-2-13.. b) A Glow Wire Flammability Index (GWFI) above 850 deg C per IEC 60695-2-12.and hence complies with the requirements set out in the International Standard IEC 60335-1 5th edition - household and similar electrical appliances - safety, section 30 Resistance to heat and fire. <P><P> The customers using this product must determine its suitability for use in their particular application through testing or other acceptable means as described in end-product glow-wire flammability test standard IEC 60695-2-11 and any applicable product end-use standard(s). <P> If it is determined during the customer's evaluation of suitability, that higher performance is required, please contact Molex for possible product options."
Overview	Micro-Fit 3.0™ Connectors
Product Literature Order No	987650-5984
Product Name	Micro-Fit 3.0™
UPC	800754315258

Physical

Breakaway	No
Circuits (Loaded)	16
Circuits (maximum)	16
Color - Resin	Black
Durability (mating cycles max)	30
Flammability	94V-0
Glow-Wire Compliant	Yes
Mated Height	10.29mm
Material - Metal	Brass
Material - Plating Mating	Tin
Material - Plating Termination	Tin

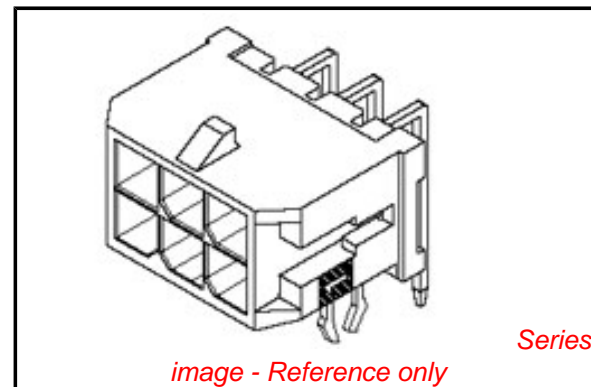

image - Reference only

EU RoHS

ELV and RoHS Compliant

REACH SVHC

Contains SVHC: No

Low-Halogen Status

Low-Halogen

China RoHS



Need more information on product environmental compliance?

Email productcompliance@molex.com
For a multiple part number RoHS Certificate of Compliance, [click here](#)

Please visit the [Contact Us](#) section for any non-product compliance questions.

Search Parts in this Series

[43045Series](#)

Mates With

[43025 Micro-Fit 3.0™ Receptacle Housing](#)

Material - Resin	High Temperature Thermoplastic
Net Weight	2.525/g
Number of Rows	2
Orientation	Right Angle
PCB Locator	Yes
PCB Retention	Yes
PCB Thickness - Recommended	1.60mm
Packaging Type	Tray
Pitch - Mating Interface	3.00mm
Plating min - Mating	0.254µm
Polarized to PCB	Yes
Shrouded	Fully
Stackable	No
Surface Mount Compatible (SMC)	Yes
Temperature Range - Operating	-40°C to +105°C
Termination Interface: Style	Through Hole

Electrical

Current - Maximum per Contact	5A
Voltage - Maximum	600V

Solder Process Data

Duration at Max. Process Temperature (seconds)	30
Lead-free Process Capability	SMC & Wave Capable (TH only)
Max. Cycles at Max. Process Temperature	3
Process Temperature max. C	260

Material Info

Reference - Drawing Numbers

Product Specification	PS-43045, RPS-43045-003, RPS-43045-004
Sales Drawing	SD-43045-001
Test Summary	TS-43045-001

This document was generated on 10/07/2014

PLEASE CHECK WWW.MOLEX.COM FOR LATEST PART INFORMATION