

Heterojunction Bipolar Transistor Technology (InGaP HBT)

Broadband High Linearity Amplifier

The MMG3002NT1 is a general purpose amplifier that is internally input and output matched. It is designed for a broad range of Class A, small-signal, high linearity, general purpose applications. It is suitable for applications with frequencies from 40 to 3600 MHz such as cellular, PCS, BWA, WLL, PHS, CATV, VHF, UHF, UMTS and general small-signal RF.

Features

- Frequency: 40–3600 MHz
- P1dB: 21 dBm @ 900 MHz
- Small-Signal Gain: 20 dB @ 900 MHz
- Third Order Output Intercept Point: 37.5 dBm @ 900 MHz
- Single Voltage Supply
- Internally Matched to 50 Ohms
- Cost-effective SOT-89 Surface Mount Plastic Package
- In Tape and Reel. T1 Suffix = 1,000 Units, 12 mm Tape Width, 7-inch Reel.

MMG3002NT1

**40–3600 MHz, 20 dB
 21 dBm
 InGaP HBT GPA**



SOT-89

Table 1. Typical Performance (1)

Characteristic	Symbol	900 MHz	2140 MHz	3500 MHz	Unit
Small-Signal Gain (S21)	G _p	20	18	14.5	dB
Input Return Loss (S11)	IRL	-16	-26	-16	dB
Output Return Loss (S22)	ORL	-12	-8	-11	dB
Power Output @ 1dB Compression	P1dB	21	21	18.5	dBm
Third Order Output Intercept Point	OIP3	37.5	36	32	dBm

1. V_{CC} = 5.2 Vdc, T_A = 25°C, 50 ohm system.

Table 2. Maximum Ratings

Rating	Symbol	Value	Unit
Supply Voltage	V _{CC}	7	V
Supply Current	I _{CC}	400	mA
RF Input Power	P _{in}	12	dBm
Storage Temperature Range	T _{stg}	-65 to +150	°C
Junction Temperature	T _J	175	°C

Table 3. Thermal Characteristics

Characteristic	Symbol	Value (2)	Unit
Thermal Resistance, Junction to Case Case Temperature 118°C, 5.2 Vdc, 110 mA, no RF applied	R _{θJC}	46.5	°C/W

2. Refer to AN1955, *Thermal Measurement Methodology of RF Power Amplifiers*. Go to <http://www.freescale.com/rf>.
 Select Documentation/Application Notes – AN1955.

NOT RECOMMENDED FOR NEW DESIGN

NOT RECOMMENDED FOR NEW DESIGN

Table 4. Electrical Characteristics ($V_{CC} = 5.2$ Vdc, 900 MHz, $T_A = 25^\circ\text{C}$, 50 ohm system, in Freescale Application Circuit)

Characteristic	Symbol	Min	Typ	Max	Unit
Small-Signal Gain (S21)	G_p	19.3	20	—	dB
Input Return Loss (S11)	IRL	—	-16	—	dB
Output Return Loss (S22)	ORL	—	-12	—	dB
Power Output @ 1dB Compression	P1dB	—	21	—	dBm
Third Order Output Intercept Point	OIP3	—	37.5	—	dBm
Noise Figure	NF	—	4.2	—	dB
Supply Current	I_{CC}	95	110	125	mA
Supply Voltage	V_{CC}	—	5.2	—	V

Table 5. Functional Pin Description

Pin Number	Pin Function
1	RF_{in}
2	Ground
3	RF_{out}/DC Supply

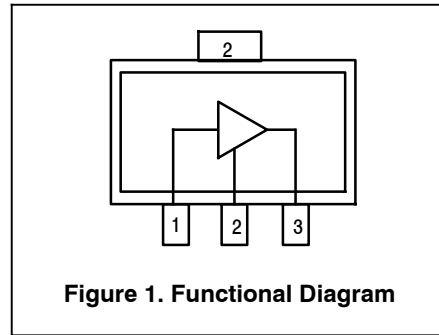

Table 6. ESD Protection Characteristics

Test Conditions/Test Methodology	Class
Human Body Model (per JESD 22-A114)	1B
Machine Model (per EIA/JESD 22-A115)	A
Charge Device Model (per JESD 22-C101)	IV

Table 7. Moisture Sensitivity Level

Test Methodology	Rating	Package Peak Temperature	Unit
Per JESD 22-A113, IPC/JEDEC J-STD-020	1	260	$^\circ\text{C}$

50 OHM TYPICAL CHARACTERISTICS

NOT RECOMMENDED FOR NEW DESIGN

NOT RECOMMENDED FOR NEW DESIGN

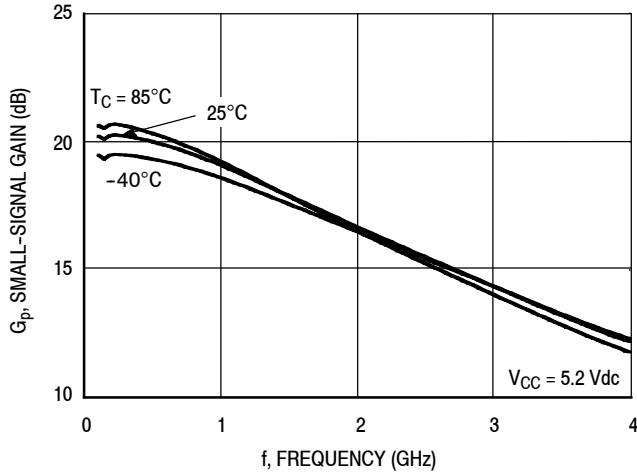

Figure 2. Small-Signal Gain (S21) versus Frequency

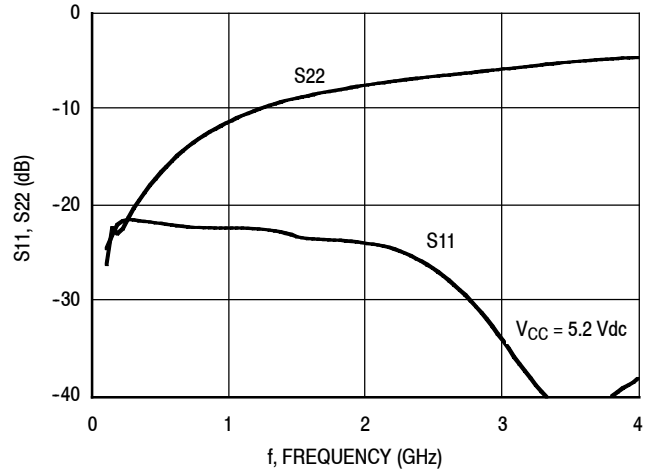

Figure 3. Input/Output Return Loss versus Frequency

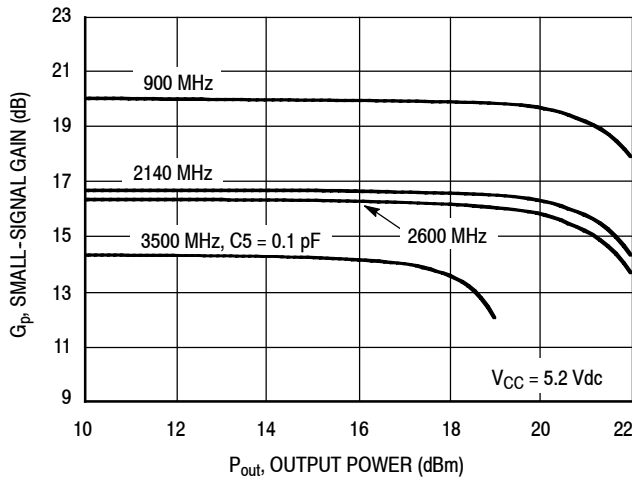

Figure 4. Small-Signal Gain versus Output Power

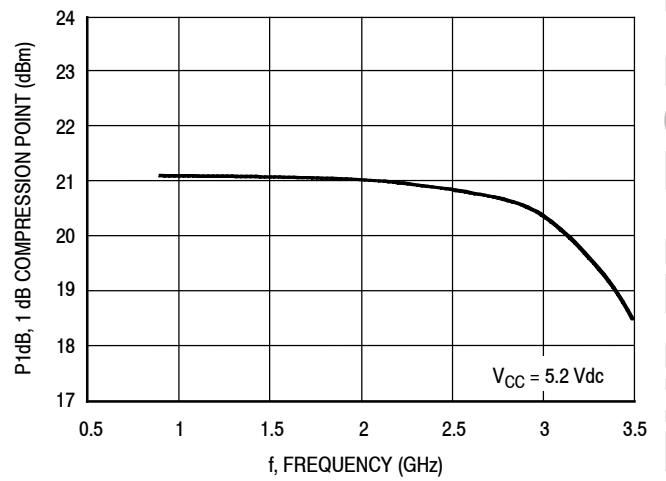

Figure 5. P1dB versus Frequency

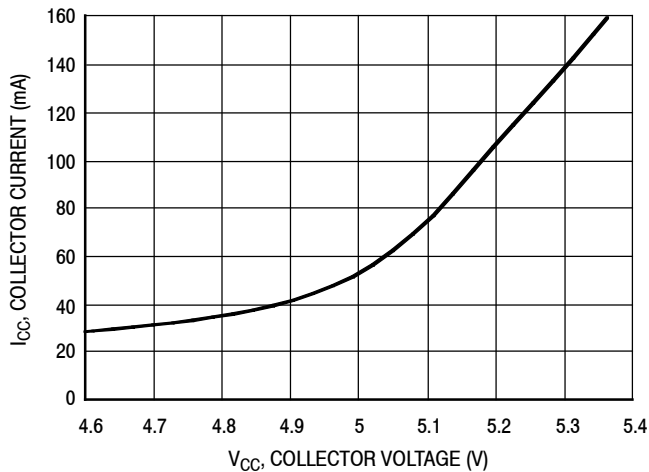

Figure 6. Collector Current versus Collector Voltage

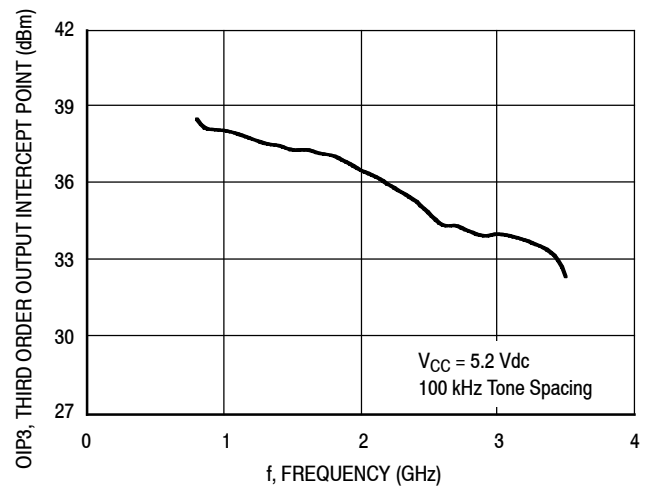

Figure 7. Third Order Output Intercept Point versus Frequency

50 OHM TYPICAL CHARACTERISTICS

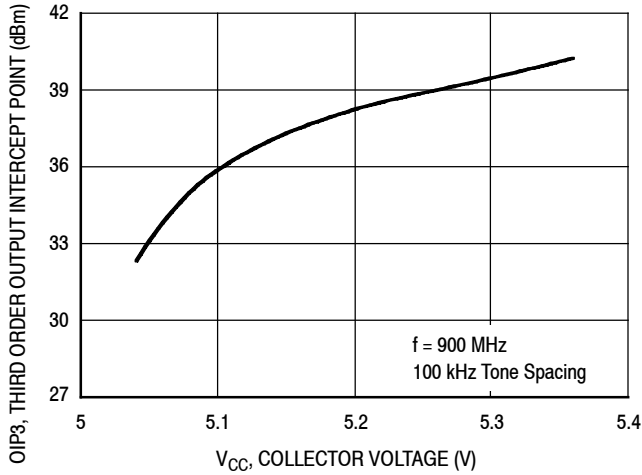

Figure 8. Third Order Output Intercept Point versus Collector Voltage

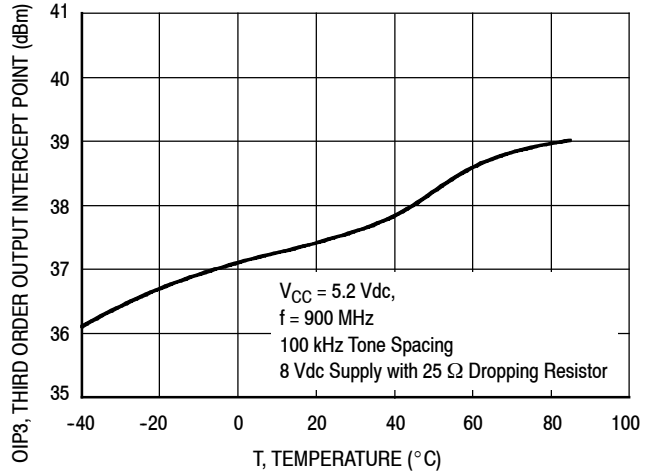

Figure 9. Third Order Output Intercept Point versus Case Temperature

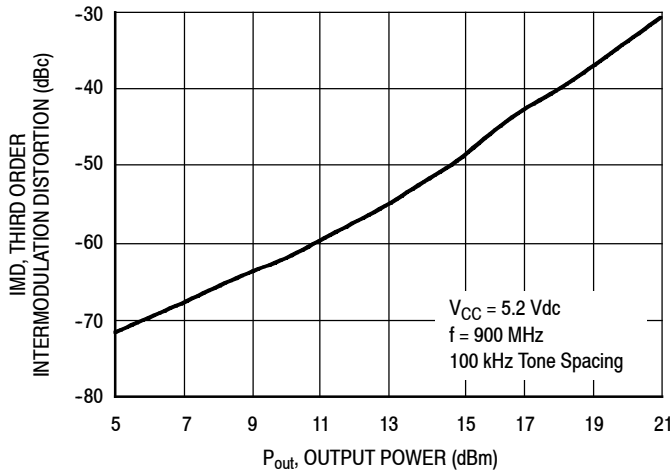
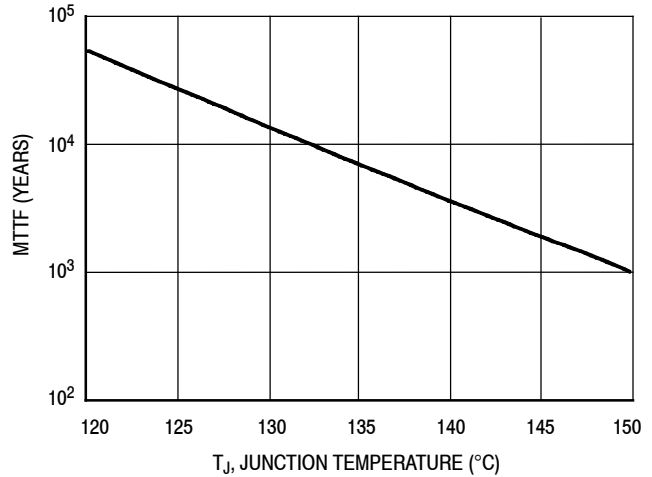

Figure 10. Third Order Intermodulation Distortion versus Output Power



NOTE: The MTTF is calculated with $V_{CC} = 5.2 \text{ Vdc}$, $I_{CC} = 110 \text{ mA}$

Figure 11. MTTF versus Junction Temperature

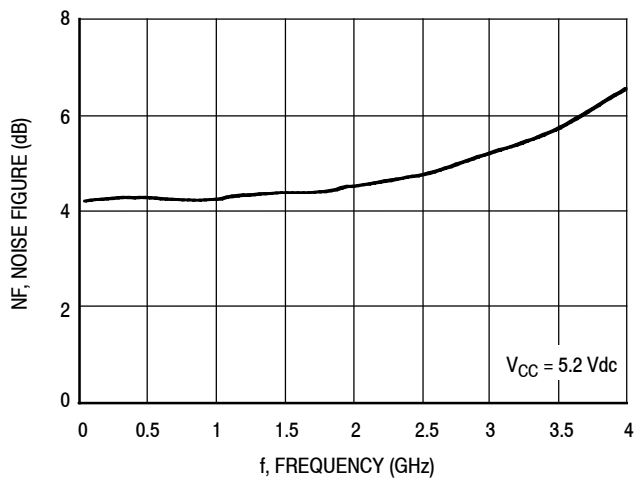

Figure 12. Noise Figure versus Frequency

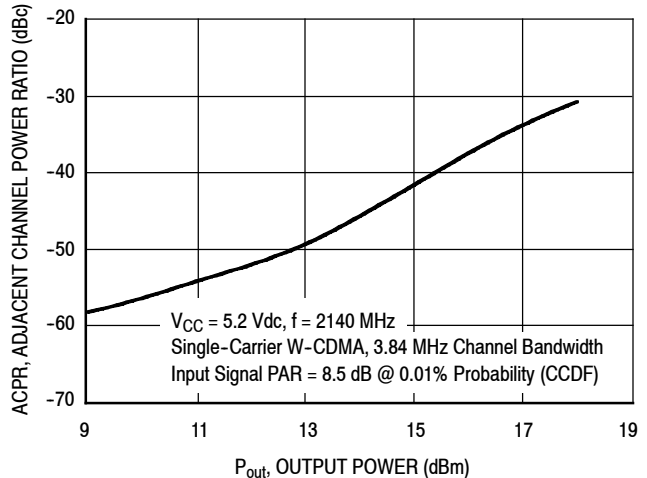

Figure 13. Single-Carrier W-CDMA Adjacent Channel Power Ratio versus Output Power

NOT RECOMMENDED FOR NEW DESIGN

NOT RECOMMENDED FOR NEW DESIGN

50 OHM APPLICATION CIRCUIT: 40-800 MHz

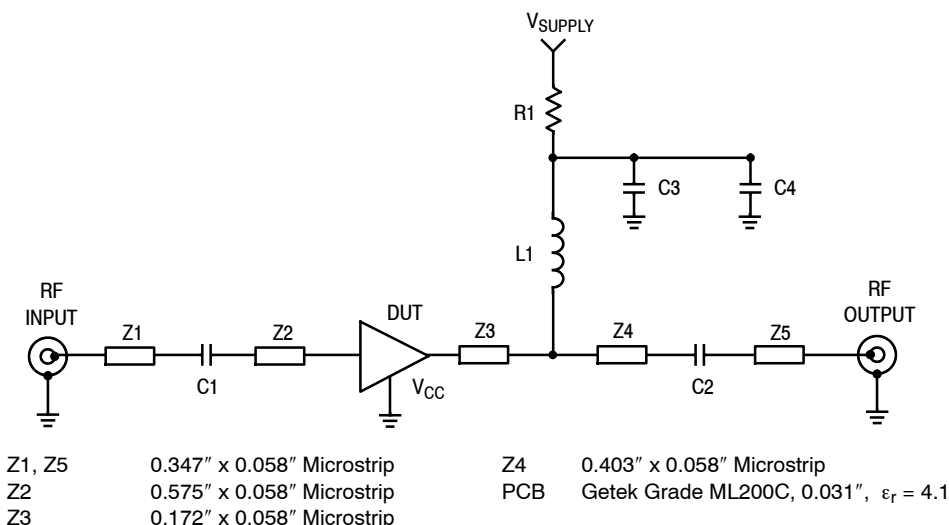

Figure 14. 50 Ohm Test Circuit Schematic

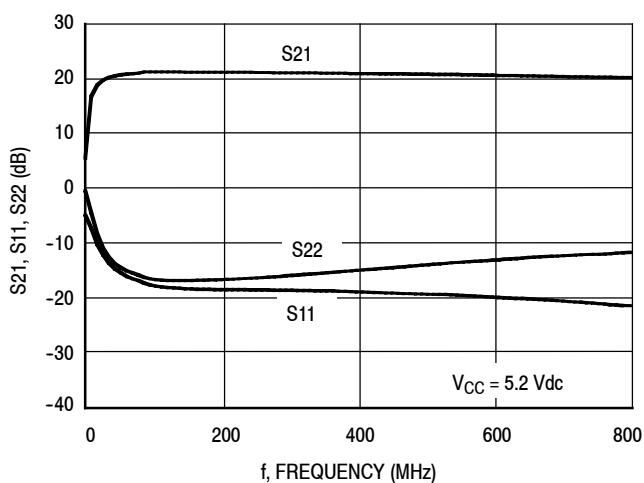

Figure 15. S21, S11 and S22 versus Frequency

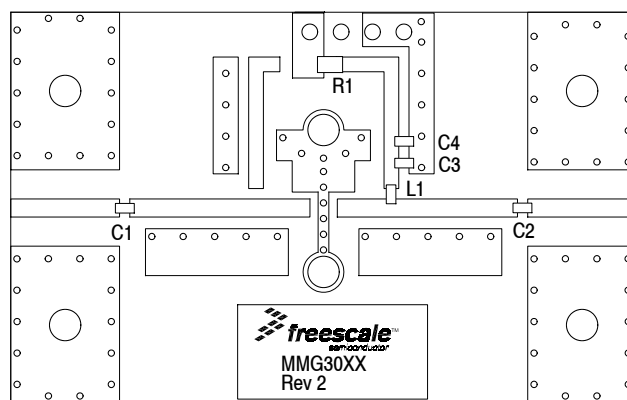

Figure 16. 50 Ohm Test Circuit Component Layout

Table 8. 50 Ohm Test Circuit Component Designations and Values

Part	Description	Part Number	Manufacturer
C1, C2	0.01 μ F Chip Capacitors	C0603C103J5RAC	Kemet
C3	0.1 μ F Chip Capacitor	C0603C104J5RAC	Kemet
C4	1 μ F Chip Capacitor	C0603C105J5RAC	Kemet
L1	470 nH Chip Inductor	BK2125HM471-T	Taiyo Yuden
R1	7.5 Ω Chip Resistor	RK73B2ATTE7R5J	KOA Speer

Table 9. Supply Voltage versus R1 Values

Supply Voltage	6	7	8	9	10	11	12	V
R1 Value	7.3	16	25	35	44	53	62	Ω

Note: To provide $V_{CC} = 5.2$ Vdc and $I_{CC} = 110$ mA at the device.

50 OHM APPLICATION CIRCUIT: 800-3400 MHz

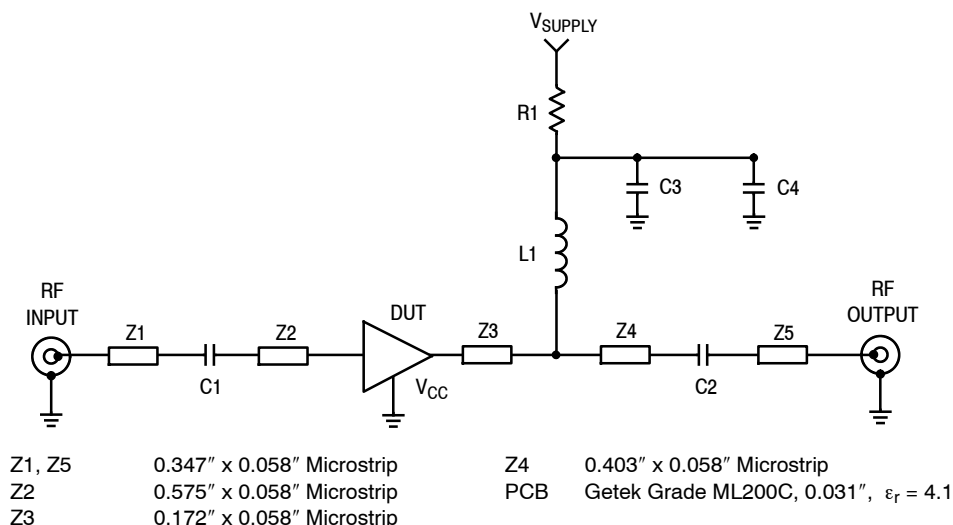

Figure 17. 50 Ohm Test Circuit Schematic

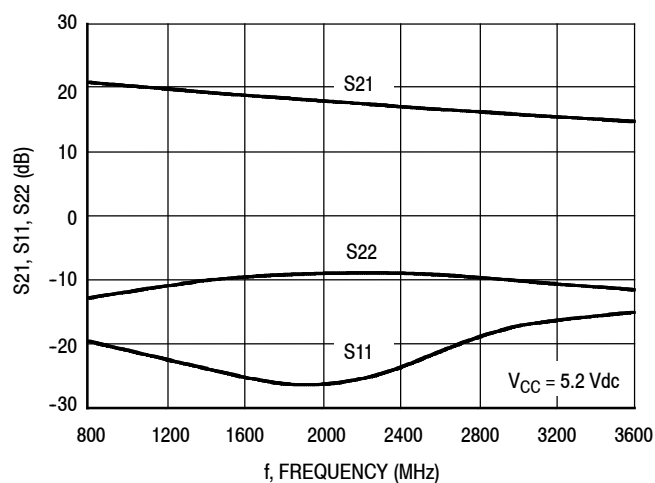

Figure 18. S21, S11 and S22 versus Frequency

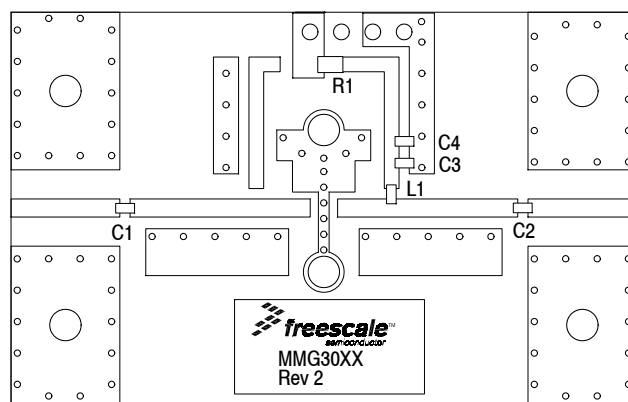

Figure 19. 50 Ohm Test Circuit Component Layout

Table 10. 50 Ohm Test Circuit Component Designations and Values

Part	Description	Part Number	Manufacturer
C1, C2	150 pF Chip Capacitors	C0603C151J5RAC	Kemet
C3	0.1 μ F Chip Capacitor	C0603C104J5RAC	Kemet
C4	1 μ F Chip Capacitor	C0603C105J5RAC	Kemet
L1	56 nH Chip Inductor	HK160856NJ-T	Taiyo Yuden
R1	7.5 Ω Chip Resistor	RK73B2ATTE7R5J	KOA Speer

NOT RECOMMENDED FOR NEW DESIGN

NOT RECOMMENDED FOR NEW DESIGN

50 OHM APPLICATION CIRCUIT: 3400-3600 MHz

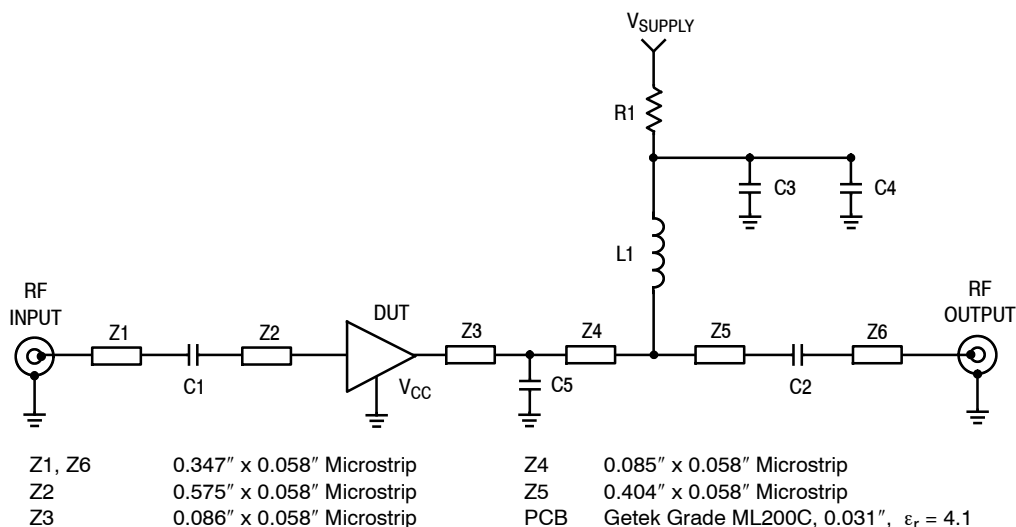

Figure 20. 50 Ohm Test Circuit Schematic

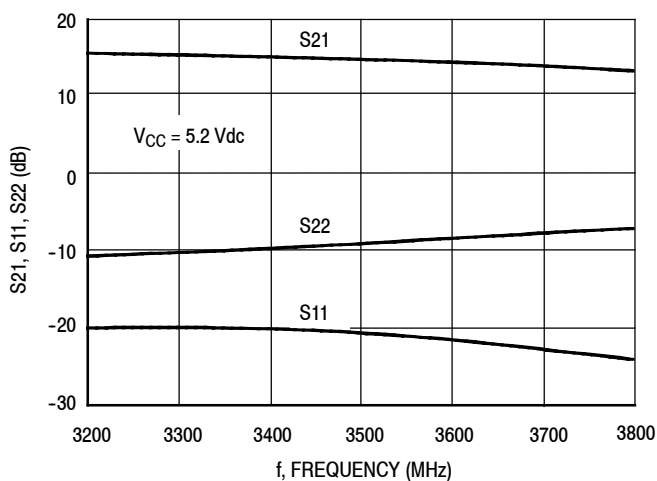

Figure 21. S21, S11 and S22 versus Frequency

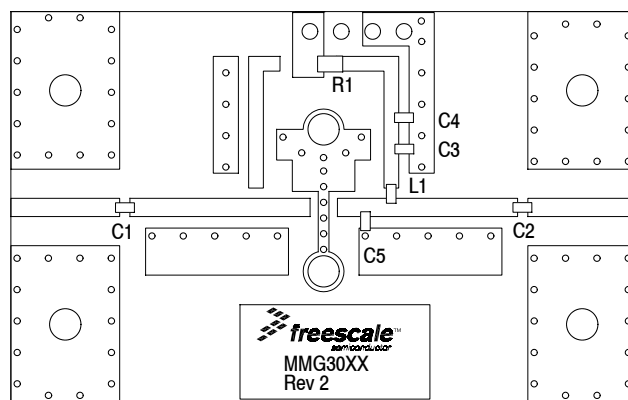

Figure 22. 50 Ohm Test Circuit Component Layout

Table 11. 50 Ohm Test Circuit Component Designations and Values

Part	Description	Part Number	Manufacturer
C1, C2	150 pF Chip Capacitors	C0603C151J5RAC	Kemet
C3	0.1 μF Chip Capacitor	C0603C104J5RAC	Kemet
C4	1 μF Chip Capacitor	C0603C105J5RAC	Kemet
C5 (1)	0.1 pF Chip Capacitor	06035J0R1BS	AVX
L1	39 nH Chip Inductor	HK160839NJ-T	Taiyo Yuden
R1	7.5 Ω Chip Resistor	RK73B2ATTE7R5J	KOA Speer

1. Tuning capacitor: Capacitor value and location on the transmission line are varied for different frequencies.

NOT RECOMMENDED FOR NEW DESIGN

NOT RECOMMENDED FOR NEW DESIGN

50 OHM TYPICAL CHARACTERISTICS

Table 12. Common Emitter S-Parameters ($V_{CC} = 5.2 \text{ Vdc}$, $T_A = 25^\circ\text{C}$, 50 Ohm System)

f MHz	S ₁₁		S ₂₁		S ₁₂		S ₂₂	
	S ₁₁	∠ φ	S ₂₁	∠ φ	S ₁₂	∠ φ	S ₂₂	∠ φ
100	0.05966	176.181	10.25158	174.805	0.07235	-0.722	0.04946	-167.612
150	0.07228	-178.627	9.96687	171.111	0.07071	-1.821	0.0953	-129.396
200	0.09041	151.476	10.46556	167.719	0.07464	-3.053	0.05913	-124.668
250	0.0909	149.96	10.36837	164.949	0.07424	-3.553	0.08015	-125.378
300	0.08882	145.472	10.30366	162.017	0.07406	-4.277	0.09694	-122.814
350	0.08508	140.833	10.2505	158.995	0.07407	-4.934	0.11062	-121.876
400	0.08377	136.078	10.17971	156.158	0.07405	-5.7	0.12723	-122.007
450	0.08191	131.492	10.10383	153.293	0.07365	-6.307	0.14156	-122.555
500	0.07982	125.857	10.02536	150.437	0.07358	-7.037	0.15558	-123.436
550	0.07776	120.816	9.94165	147.642	0.07346	-7.676	0.1685	-124.8
600	0.0773	115.435	9.85596	144.898	0.07336	-8.2	0.18177	-126.796
650	0.07677	110.371	9.76098	142.109	0.07321	-8.911	0.19472	-128.506
700	0.07664	104.874	9.6623	139.374	0.07301	-9.464	0.20662	-130.47
750	0.07628	100.112	9.56168	136.692	0.0729	-10.069	0.21833	-132.663
800	0.07619	95.73	9.45426	134.024	0.07275	-10.618	0.22977	-134.835
850	0.07601	91.72	9.34921	131.391	0.07273	-11.184	0.24125	-137.084
900	0.07567	87.313	9.23967	128.792	0.07257	-11.821	0.25232	-139.685
950	0.07642	83.036	9.13144	126.149	0.07238	-12.312	0.26303	-142.257
1000	0.07619	80.021	9.01205	123.659	0.07228	-12.88	0.27394	-144.736
1050	0.07666	76.201	8.90327	121.137	0.07218	-13.474	0.28332	-147.346
1100	0.07678	73.008	8.78013	118.657	0.07202	-13.93	0.29417	-150.042
1150	0.07673	70.68	8.66342	116.191	0.0719	-14.519	0.30394	-152.767
1200	0.07674	68.773	8.53991	113.779	0.07178	-15.062	0.31393	-155.358
1250	0.07628	66.216	8.42251	111.392	0.07176	-15.551	0.32286	-157.992
1300	0.07618	64.635	8.30514	109.034	0.07164	-16.115	0.33259	-160.483
1350	0.07454	62.959	8.18109	106.673	0.07149	-16.539	0.34127	-162.981
1400	0.07373	60.65	8.06498	104.367	0.07152	-17.114	0.34972	-165.377
1450	0.0724	59.062	7.94403	102.073	0.07137	-17.565	0.35931	-167.823
1500	0.06466	48.656	7.85198	99.72	0.0715	-18.187	0.35762	-170.82
1550	0.0646	44.563	7.73641	97.503	0.07167	-18.755	0.36484	-172.845
1600	0.06495	39.856	7.63068	95.372	0.07161	-19.217	0.37158	-174.751
1650	0.0657	35.953	7.52257	93.247	0.07165	-19.614	0.37821	-176.697
1700	0.06599	31.949	7.43591	91.089	0.07171	-20.239	0.38558	-178.85
1750	0.0666	28.693	7.31976	88.981	0.07168	-20.731	0.39036	179.588
1800	0.06649	25.448	7.22121	86.872	0.07176	-21.241	0.39732	177.775
1850	0.06637	22.687	7.11782	84.83	0.07181	-21.685	0.40211	175.992
1900	0.06563	19.369	7.01794	82.771	0.07188	-22.233	0.40749	174.294
1950	0.06514	15.516	6.91688	80.824	0.07197	-22.678	0.41306	172.684
2000	0.0641	13.294	6.82126	78.739	0.07217	-23.218	0.41825	170.97
2050	0.06323	9.843	6.72865	76.797	0.07214	-23.632	0.42367	169.372
2100	0.06288	6.976	6.63794	74.849	0.07234	-24.15	0.42905	167.644
2150	0.06195	4.218	6.55483	72.888	0.07244	-24.689	0.43442	166.014
2200	0.06084	2.075	6.46275	70.939	0.07265	-25.273	0.43857	164.274
2250	0.05942	-0.3	6.37821	69.013	0.07275	-25.755	0.44419	162.598

(continued)

NOT RECOMMENDED FOR NEW DESIGN

NOT RECOMMENDED FOR NEW DESIGN

50 OHM TYPICAL CHARACTERISTICS

Table 12. Common Emitter S-Parameters ($V_{CC} = 5.2 \text{ Vdc}$, $T_A = 25^\circ\text{C}$, 50 Ohm System) (continued)

f MHz	S ₁₁		S ₂₁		S ₁₂		S ₂₂	
	S ₁₁	∠ φ	S ₂₁	∠ φ	S ₁₂	∠ φ	S ₂₂	∠ φ
2300	0.05808	-2.187	6.29055	67.098	0.07295	-26.316	0.44756	160.879
2350	0.05526	-4.038	6.20851	65.179	0.07318	-26.813	0.45231	159.11
2400	0.05338	-6.096	6.12256	63.315	0.07337	-27.387	0.45571	157.425
2450	0.05054	-7.643	6.04461	61.45	0.07359	-27.903	0.46063	155.679
2500	0.04768	-10.036	5.96594	59.564	0.07386	-28.462	0.46419	153.884
2550	0.04494	-12.811	5.88833	57.733	0.07416	-29.19	0.4681	152.005
2600	0.04239	-14.731	5.81782	55.868	0.07435	-29.754	0.47249	150.142
2650	0.0393	-16.676	5.74121	53.98	0.07445	-30.312	0.47601	148.126
2700	0.03707	-20.889	5.66538	52.04	0.0748	-31.053	0.47991	146.214
2750	0.0346	-21.7	5.59155	50.247	0.07499	-31.654	0.48371	144.147
2800	0.03163	-24.056	5.51967	48.401	0.07519	-32.344	0.48777	142.183
2850	0.02869	-26.756	5.44631	46.54	0.0754	-33.048	0.49144	140.072
2900	0.02667	-28.324	5.37422	44.74	0.07563	-33.749	0.4961	138.081
2950	0.02324	-29.457	5.30336	42.914	0.07577	-34.431	0.50017	136.001
3000	0.02069	-34.403	5.23613	41.138	0.07596	-35.209	0.5054	133.872
3050	0.01861	-37.625	5.16698	39.322	0.07624	-35.917	0.50901	131.91
3100	0.01563	-41.101	5.09908	37.495	0.07648	-36.648	0.51431	129.855
3150	0.01407	-49.967	5.03148	35.696	0.0766	-37.389	0.51844	127.844
3200	0.01296	-54.052	4.96452	33.935	0.07684	-38.12	0.52333	125.818
3250	0.01129	-59.44	4.89769	32.159	0.07708	-38.894	0.52814	123.86
3300	0.01031	-67.904	4.83271	30.407	0.07721	-39.663	0.53368	121.891
3350	0.00977	-71.657	4.76883	28.702	0.07742	-40.479	0.53765	120.096
3400	0.00821	-77.779	4.707	26.984	0.07764	-41.116	0.54299	118.206
3450	0.0076	-90.054	4.64886	25.288	0.07774	-41.964	0.54702	116.357
3500	0.0074	-97.151	4.59041	23.575	0.07797	-42.707	0.55121	114.75
3550	0.00666	-114.876	4.5319	21.885	0.07819	-43.538	0.55593	113.11
3600	0.00749	-127.171	4.47455	20.231	0.07843	-44.293	0.55935	111.522

NOT RECOMMENDED FOR NEW DESIGN

NOT RECOMMENDED FOR NEW DESIGN

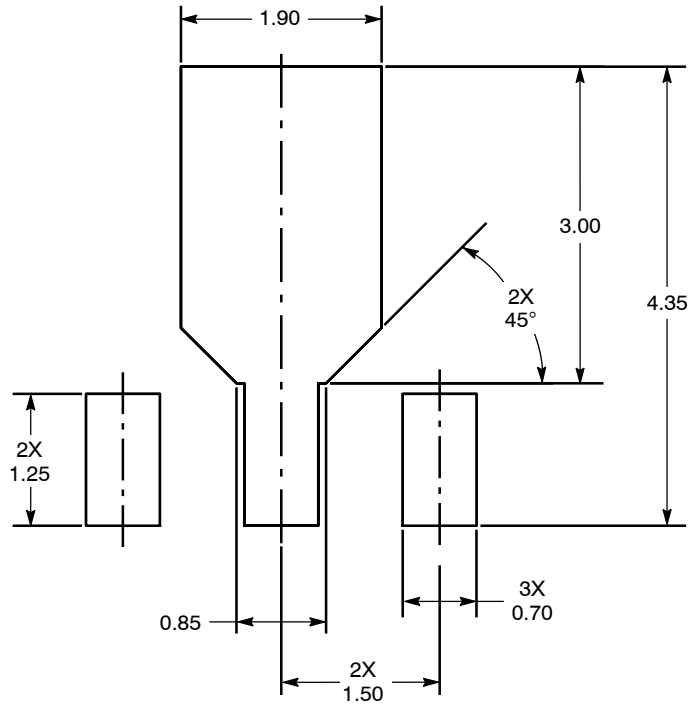

Figure 23. PCB Pad Layout for SOT-89A

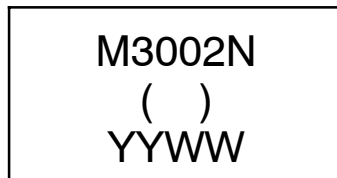
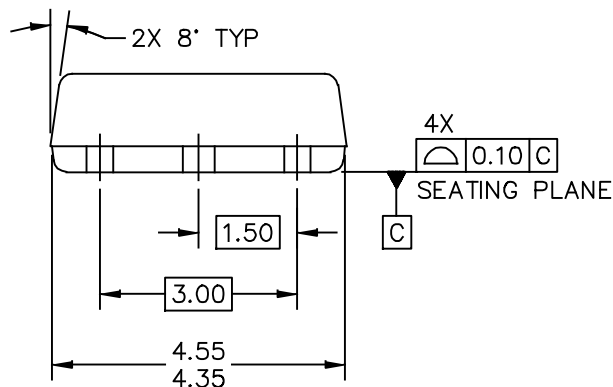
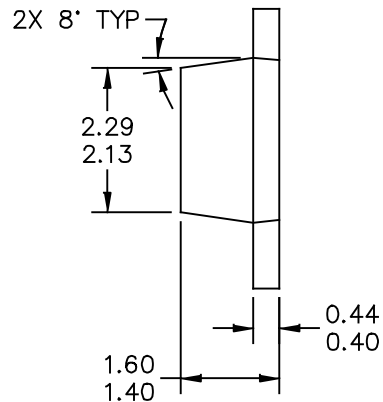
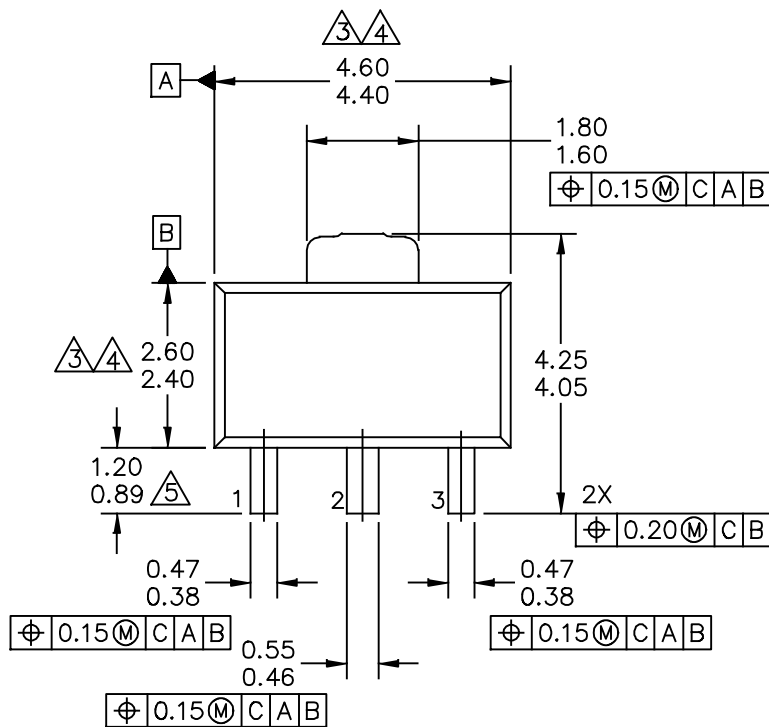

Figure 24. Product Marking

PACKAGE DIMENSIONS



NOT RECOMMENDED FOR NEW DESIGN

NOT RECOMMENDED FOR NEW DESIGN

© FREESCALE SEMICONDUCTOR, INC. ALL RIGHTS RESERVED.		MECHANICAL OUTLINE		PRINT VERSION NOT TO SCALE	
TITLE: SOT-89A, 3 LEAD, 4.5 X 2.5 PKG, 1.5 MM PITCH		DOCUMENT NO: 98ASA00241D		REV: 0	
		CASE NUMBER: 2142-01		15 JUL 2010	
		STANDARD: NON-JEDEC			

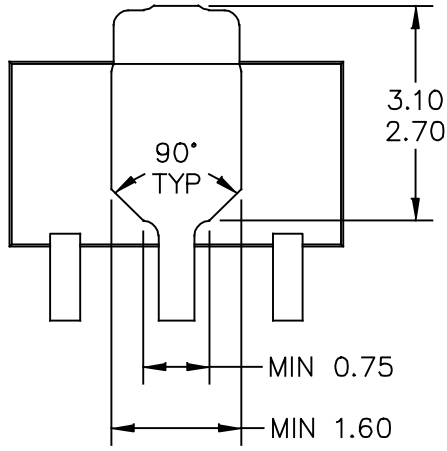

BOTTOM VIEW

© FREESCALE SEMICONDUCTOR, INC. ALL RIGHTS RESERVED.	MECHANICAL OUTLINE	PRINT VERSION NOT TO SCALE	
TITLE: SOT-89A, 3 LEAD, 4.5 X 2.5 PKG, 1.5 MM PITCH	DOCUMENT NO: 98ASA00241D	REV: 0	
	CASE NUMBER: 2142-01	15 JUL 2010	
	STANDARD: NON-JEDEC		

NOT RECOMMENDED FOR NEW DESIGN

NOT RECOMMENDED FOR NEW DESIGN

NOTES:

- 1. DIMENSIONING AND TOLERANCING PER ASME Y14.5M – 1994.
- 2. ALL DIMENSIONS ARE IN MILLIMETERS.

3. DIMENSIONS DOES NOT INCLUDE MOLD FLASH. PROTRUSIONS OR GATE BURRS. MOLD FLASH, PROTRUSIONS OR GATE BURRS SHALL NOT EXCEED 0.5 MM PER END. DIMENSION DOES NOT INCLUDE INTERLEAD FLASH OR PROTRUSION. INTERLEAD FLASH OR PROTRUSION SHALL NOT EXCEED 0.5 MM PER SIDE.

4. DIMENSION ARE DETERMINED AT THE OUTMOST EXTREMES OF THE PLASTIC BODY EXCLUSIVE OF MOLD FLASH, TIE BAR BURRS, GATE BURRS AND INTERLEAD FLASH, BUT INCLUDING ANY MISMATCH BETWEEN THE TOP AND BOTTOM OF THE PLASTIC BODY.

5. TERMINAL NUMBERS ARE SHOWN FOR REFERENCE ONLY.

© FREESCALE SEMICONDUCTOR, INC. ALL RIGHTS RESERVED.		MECHANICAL OUTLINE		PRINT VERSION NOT TO SCALE	
TITLE: SOT-89A, 3 LEAD, 4.5 X 2.5 PKG, 1.5 MM PITCH			DOCUMENT NO: 98ASA00241D		REV: 0
			CASE NUMBER: 2142-01		15 JUL 2010
			STANDARD: NON-JEDEC		

PRODUCT DOCUMENTATION AND SOFTWARE

Refer to the following resources to aid your design process.

Application Notes

- AN1955: Thermal Measurement Methodology of RF Power Amplifiers
- AN3100: General Purpose Amplifier and MMIC Biasing

Software

- .s2p File

For Software, do a Part Number search at <http://www.freescale.com>, and select the “Part Number” link. Go to Software & Tools on the part’s Product Summary page to download the respective tool.

FAILURE ANALYSIS

At this time, because of the physical characteristics of the part, failure analysis is limited to electrical signature analysis. In cases where Freescale is contractually obligated to perform failure analysis (FA) services, full FA may be performed by third party vendors with moderate success. For updates contact your local Freescale Sales Office.

REVISION HISTORY

The following table summarizes revisions to this document.

Revision	Date	Description
7	Mar. 2007	<ul style="list-style-type: none">• Corrected and updated Part Numbers in Tables 8, 10 and 11, Component Designations and Values, to RoHS compliant part numbers, pp. 6-8
8	July 2007	<ul style="list-style-type: none">• Replaced Case Outline 1514-01 with 1514-02, Issue D, pp. 1, 12-14. Case updated to add missing dimension for Pin 1 and Pin 3.
9	Mar. 2008	<ul style="list-style-type: none">• Removed Footnote 2, Continuous voltage and current applied to device, from Table 2, Maximum Ratings, p. 1• Corrected Fig. 13, Single-Carrier W-CDMA Adjacent Channel Power Ratio versus Output Power y-axis (ACPR) unit of measure to dBc, p. 5• Corrected S-Parameter table frequency column label to read “MHz” versus “GHz” and corrected frequency values from GHz to MHz, pp. 9, 10
10	Feb. 2012	<ul style="list-style-type: none">• Corrected temperature at which Theta_{JC} is measured from 25°C to 118°C and added “no RF applied” to Thermal Characteristics table to indicate that thermal characterization is performed under DC test with no RF signal applied, p. 1• Table 6, ESD Protection Characteristics, removed the word “Minimum” after the ESD class rating. ESD ratings are characterized during new product development but are not 100% tested during production. ESD ratings provided in the data sheet are intended to be used as a guideline when handling ESD sensitive devices, p. 3• Removed I_{CC} bias callout from applicable graphs and Table 12, Common Emitter S-Parameters heading as bias is not a controlled value, pp. 4-10• Added .s2p File availability to Product Software, p. 15
11	Dec. 2012	<ul style="list-style-type: none">• Replaced the PCB Pad Layout drawing, the package isometric and mechanical outline for Case 1514-02 (SOT-89) with Case 2142-01 (SOT-89) as a result of the device transfer from a Freescale wafer fab to an external GaAs wafer fab and new assembly site. The new assembly and test site’s SOT-89 package has slight dimensional differences, pp. 1, 11-14. Refer to PCN13337, <i>GaAs Fab Transfer</i>.• Added Fig. 24, Product Marking, p. 11
12	Sept. 2014	<ul style="list-style-type: none">• Table 2, Maximum Ratings: updated Junction Temperature from 150°C to 175°C to reflect recent test results of the device, p. 1• Added Failure Analysis information, p. 14

How to Reach Us:**Home Page:**
freescale.com**Web Support:**
freescale.com/support

Information in this document is provided solely to enable system and software implementers to use Freescale products. There are no express or implied copyright licenses granted hereunder to design or fabricate any integrated circuits based on the information in this document.

Freescale reserves the right to make changes without further notice to any products herein. Freescale makes no warranty, representation, or guarantee regarding the suitability of its products for any particular purpose, nor does Freescale assume any liability arising out of the application or use of any product or circuit, and specifically disclaims any and all liability, including without limitation consequential or incidental damages. "Typical" parameters that may be provided in Freescale data sheets and/or specifications can and do vary in different applications, and actual performance may vary over time. All operating parameters, including "typicals," must be validated for each customer application by customer's technical experts. Freescale does not convey any license under its patent rights nor the rights of others. Freescale sells products pursuant to standard terms and conditions of sale, which can be found at the following address: freescale.com/SalesTermsandConditions.

Freescale and the Freescale logo are trademarks of Freescale Semiconductor, Inc., Reg. U.S. Pat. & Tm. Off. All other product or service names are the property of their respective owners.

© 2004-2008, 2012, 2014 Freescale Semiconductor, Inc.

