

Multi-stage high-performance filter FN 2080

- Current ratings from 1 to 16A
 - Very high differential and common mode attenuation
 - Good low-frequency attenuation
 - Optional medical versions (B types)
-
- Nennströme von 1 bis 16A
 - Sehr hohe Gleich- und Gegentaktdämpfung
 - Gute Niederfrequenzdämpfung
 - Optionale medizinische Versionen (Typ B)
-
- Courants de service de 1 à 16A
 - Très bonne atténuation en modes différentiel et commun
 - Bonne atténuation à des basses fréquences
 - En option version pour appareils médicaux (type B)



Filter selection table

Choose the filter FN xxxx-x with the required current rating and features, and add /?? to determine input/output (line/load) connection style. Example: FN 2080-10/06 is a 10A filter with fast-on connections.

Approvals



Filter	Connections			Current ratings at 40°C (25°) A	Inductance		Capacitance		Resistance R MΩ	Housing	Weight g
					L mH	L1 mH	Cx μF	Cy nF			
FN 2080 -1 /??	/06	/07		1 (1.15)	22	0.49	0.33	4.7	1	K1	200
FN 2080 -3 /??	/06	/07		3 (3.45)	9.8	0.16	0.47	4.7	0.47	K2	270
FN 2080 -6 /??	/06	/07		6 (6.9)	7.8	0.11	1	4.7	0.22	P	470
FN 2080 -10 /??	/06	/07		10 (11.5)	4.5	0.06	1	4.7	0.22	Q	750
FN 2080 -12 /??	/06	/07		12 (13.8)	3.25	0.05	1	4.7	0.22	Q	750
FN 2080 -16 /??	/06	/07	/08	16 (18.4)	2.8	0.043	1	4.7	0.22	L2	1020

Additional specifications

Filter type	Maximum operating voltage		Operating frequency Hz	Hipot test voltage		MTBF Per Mil-HB-217F at 40°C 230V hours	Maximum leakage mA/phase
	VAC	Hz		PN→E VAC	P→N VDC		
Standard types	250	50/60	DC to 400	2000	1700	1 650 000	0.4
B medical types (no Y capacitors)	250	50/60	DC to 400	2500	1700	1 700 000	0.002
A safety types (lower capacitance)	250	50/60	DC to 400	2500	1700	1 650 000	0.040

Electrical schematic

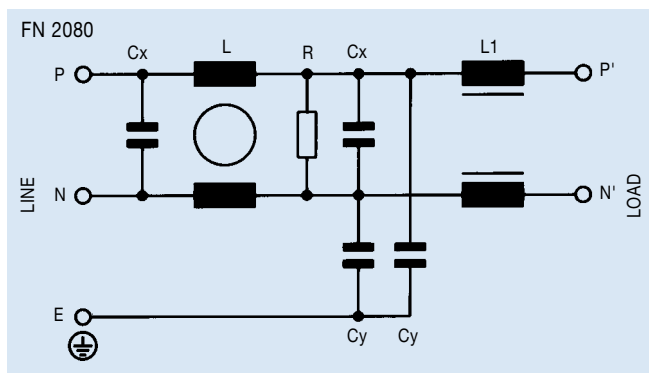

See tables for component values.

FN 2080 insertion loss

Per CISPR 17; A = 50Ω/50Ω sym, B = 50Ω/50Ω asym, C = 0.1Ω/100Ω sym, D = 100Ω/0.1Ω sym

1A types

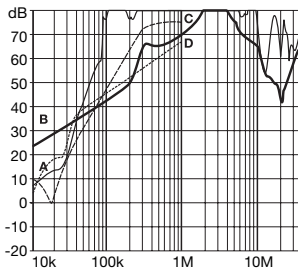

3A types

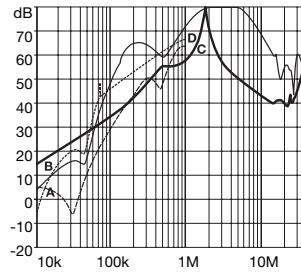

6A types

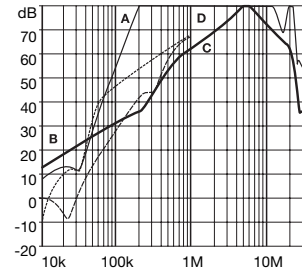

10A types (12A*)

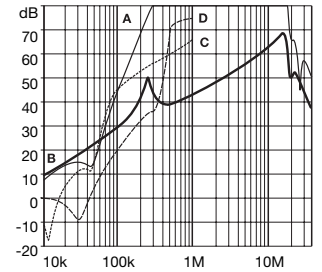

16A types

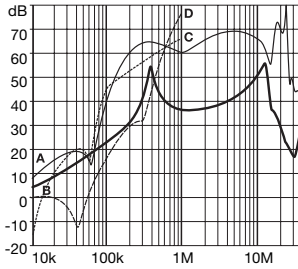

* attenuation performance of the 12A version is similar to the 10A component.

Mechanical data

Housing style	K1	K2	Tol. ± mm
A	85		± 0.5
B	54		± 0.5
C	30.3	40.3	± 0.5
D	64.8		± 0.5
F	75		± 0.3
J	27		± 0.2
K	12.3/8.3 [§]		± 0.5
L	20.8/23.3	29.8	± 0.5
M	5.3		± 0.1
N	6.3		± 0.1
P	0.7		± 0.1
S	19.9/34.9 [§]	11.4/34.9 [§]	± 0.5

§ with /07 connections
wire length of /07: 140 +5 mm

Housing style	P	Q	L2	Tol.* ± mm
A	113.5	156	119 ± 0.5	± 1
B	57.5		85.5	± 1
C	45.4 ± 1.2		57.6	± 1
D	94	130.5	98.5	± 1
F	103	143	109	± 0.3
J	25	40	40	± 0.2
K	12.4/8.4 [§]		15.6/8.6 [§]	± 0.5
L	32.4			± 0.5
M	4.4	5.3	4.4	± 0.1
N	6		7.4	± 0.1
P	0.9		1.2	± 0.1
Q			66	± 0.3
R			51	± 0.2
S	15.5/38 [§]			± 0.5

§ with /07 connections
wire length of /07: 140 +5 mm

* Measurements share this common tolerance unless otherwise stated.

All dimensions in mm; 1 inch = 25.4 mm

Front

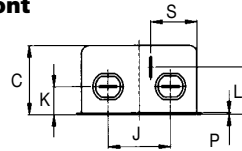

Top

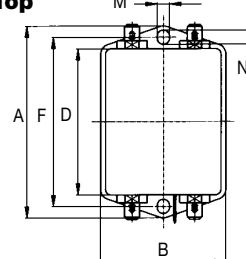

Housings K1, K2

Front

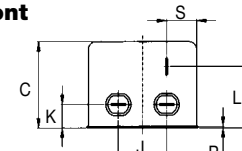

Top

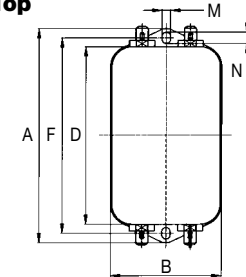

Housings P, Q

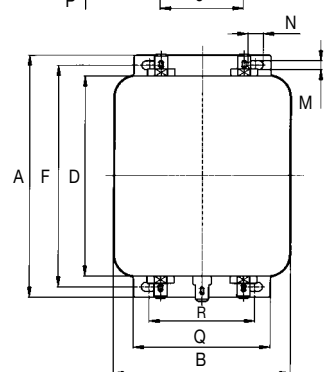
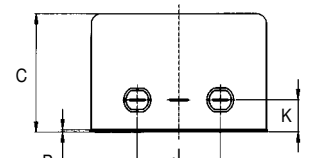

Housing L2