

# ASMT-YTB7-0AA02

## Tricolor PLCC6 Black Surface LED



### Data Sheet



Lead (Pb) Free  
RoHS 6 fully  
compliant



#### Description

This family of SMT LEDs packaged in the form of PLCC-6 with separate heat path for each LED dice, enabling it to be driven at higher current.

Individually addressable pin-outs give higher flexibility in circuitry design. With closely matched radiation pattern along the package's x-axis, these LEDs are suitable for indoor full color display application. The black top surface of the LED provides better contrast enhancement.

For easy pick and place, the LEDs are shipped in tape and reel. Every reel is shipped from a single intensity and color bin for better uniformity.

These LEDs are compatible with reflow soldering process.

#### Features

- Standard PLCC-6 package (Plastic Leaded Chip Carrier) with individual addressable pin-out for higher flexibility of driving configuration
- LED package with diffused silicone encapsulation
- Using AlInGaP and InGaN dice technologies
- Typical viewing angle 120°
- Compatible with reflow soldering process
- JEDEC MSL 3
- Water-Resistance (IPX6\*) per IEC 60529:2001
  - \* The test is conducted on the component level by mounting the components on the PCB with proper potting to protect the leads. It is strongly recommended that customers perform the necessary tests on the components for their final application.

#### Applications

- Full color display

**CAUTION:** These LEDs are Class 1C ESD sensitive. Observe appropriate precautions during handling and processing. For additional details, refer to Avago Application Note AN-1142.

**CAUTION:** Customer is advised to keep the LED in the MBB when not in use as prolonged exposure to environment might cause the silver-plated leads to tarnish, which might cause difficulties in soldering.

## Package Dimensions

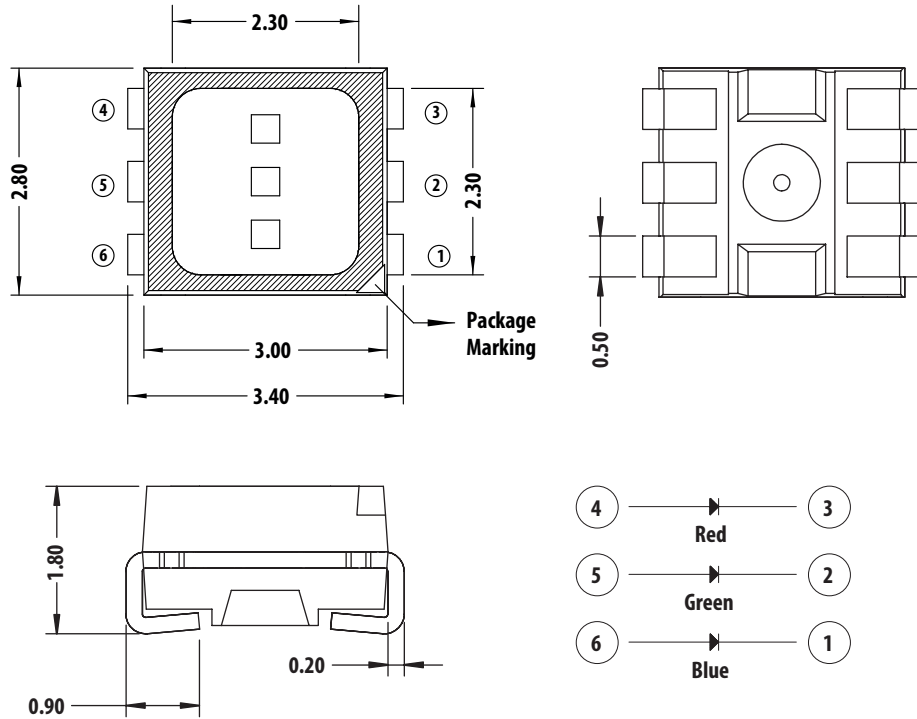

## Lead Configuration

1	Cathode (Blue)
2	Cathode (Green)
3	Cathode (Red)
4	Anode (Red)
5	Anode (Green)
6	Anode (Blue)

### Notes:

1. All dimensions are in millimeter (mm).
2. Unless otherwise specified, tolerance is  $\pm 0.20$  mm.
3. Encapsulation = silicone
4. Terminal finish = silver plating

**Table 1. Absolute Maximum Ratings (T<sub>J</sub> = 25 °C)**

Parameter	Red	Green & Blue	Unit
DC forward current [1]	50	25	mA
Peak forward current [2]	100	100	mA
Power dissipation	125	90	mW
Maximum junction temperature T <sub>J</sub> max	110		°C
Operating temperature range	- 40 to + 100		°C
Storage temperature range	- 40 to + 100		°C

Notes:

1. Derate linearly as shown in Figure 7 to Figure 10.
2. Duty Factor = 10% Frequency = 1 kHz.

**Table 2. Optical Characteristics (T<sub>J</sub> = 25 °C)**

Color	Luminous Intensity, I <sub>V</sub> (mcd) @ I <sub>F</sub> = 20 mA [1]			Dominant Wavelength, λ <sub>d</sub> (nm) @ I <sub>F</sub> = 20 mA [2]			Peak Wavelength, λ <sub>p</sub> (nm) @ I <sub>F</sub> = 20 mA	Viewing Angle, 2θ <sub>1/2</sub> (°) [3]	Test Current (mA)
	Min.	Typ.	Max.	Min.	Typ.	Max.	Typ.	Typ.	
Red	560	650	1125	617	623	627	630	120	20
Green	1400	1900	2850	525	529	537	522	120	
Blue	285	384	560	465	469	475	465	120	

Notes:

1. Luminous intensity, I<sub>V</sub> is measured at the mechanical axis of the LED package at a single current pulse condition. The actual peak of the spatial radiation pattern may not be aligned with the axis.
2. Dominant wavelength is derived from the CIE Chromaticity Diagram and represents the perceived color of the device.
3. θ<sub>1/2</sub> is the off-axis angle where the luminous intensity is 1/2 of the peak intensity.

**Table 3. Electrical Characteristics (T<sub>J</sub> = 25 °C)**

Color	Forward Voltage, V <sub>F</sub> (V) @ I <sub>F</sub> = 20 mA [1]			Reverse Voltage, V <sub>R</sub> (V) @ I <sub>R</sub> = 100 μA [2]	Reverse Voltage, V <sub>R</sub> (V) @ I <sub>R</sub> = 10 μA [2]	Thermal Resistance, R <sub>θJ-S</sub> (°C/W)	
	Min.	Typ.	Max.	Min.	Min.	1 chip on	3 chips on
Red	1.8	2.1	2.5	4.0	--	280	330
Green	2.8	3.1	3.6	--	4.0	240	357
Blue	2.8	3.1	3.6	--	4.0	240	357

Notes:

1. Tolerance = ±0.1 V.
2. Indicates product final testing condition. Long term reverse bias is not recommended.

## Part Numbering System

A S M T - Y T B 7 - 0 A A 0 2

x1

x2 x3 x4 x5

Code	Description	Option	
x1	Package type	B	Black surface
x2	Minimum intensity bin	A	Red: bin U2 Green: bin W2 Blue: bin T1
			Red: bin U2,V1,V2 Green: bin W2, X1, X2 Blue: bin T1, T2, U1
x3	Number of intensity bins	A	3 intensity bins from minimum
x4	Color bin combination	0	Red: full distribution Green: bin A, B, C Blue: bin A, B, C, D
x5	Test option	2	Test current = 20mA

**Table 4. Bin Information**

### Intensity Bins (CAT)

Bin ID	Luminous intensity (mcd)	
	Min	Max
T1	285	355
T2	355	450
U1	450	560
U2	560	715
V1	715	900
V2	900	1125
W1	1125	1400
W2	1400	1800
X1	1800	2240
X2	2240	2850

Tolerance:  $\pm 12\%$

### Color Bins (BIN) – Blue

Bin ID	Dominant Wavelength (nm)		Chromaticity coordinate (for reference)	
	Min.	Max.	Cx	Cy
A	465.0	469.0	0.1355	0.0399
			0.1751	0.0986
			0.1680	0.1094
			0.1267	0.0534
B	467.0	471.0	0.1314	0.0459
			0.1718	0.1034
			0.1638	0.1167
			0.1215	0.0626
C	469.0	473.0	0.1267	0.0534
			0.1680	0.1094
			0.1593	0.1255
			0.1158	0.0736
D	471.0	475.0	0.1215	0.0626
			0.1638	0.1167
			0.1543	0.1361
			0.1096	0.0868

Tolerance:  $\pm 1\text{nm}$

### Color Bins (BIN) – Green

Bin ID	Dominant Wavelength (nm)		Chromaticity Coordinate (for reference)	
	Min.	Max.	Cx	Cy
A	525.0	531.0	0.1142	0.8262
			0.1624	0.7178
			0.2001	0.6983
			0.1625	0.8012
B	528.0	534.0	0.1387	0.8148
			0.1815	0.7089
			0.2179	0.6870
			0.1854	0.7867
C	531.0	537.0	0.1625	0.8012
			0.2001	0.6983
			0.2353	0.6747
			0.2077	0.7711

Tolerance:  $\pm 1\text{ nm}$

### Color Bins (BIN) – Red

Bin ID	Dominant Wavelength (nm)		Chromaticity Coordinate (for reference)	
	Min.	Max.	Cx	Cy
--	617.0	627.0	0.6850	0.3149
			0.6815	0.3150
			0.7000	0.2966
			0.7037	0.2962

Tolerance:  $\pm 1\text{nm}$

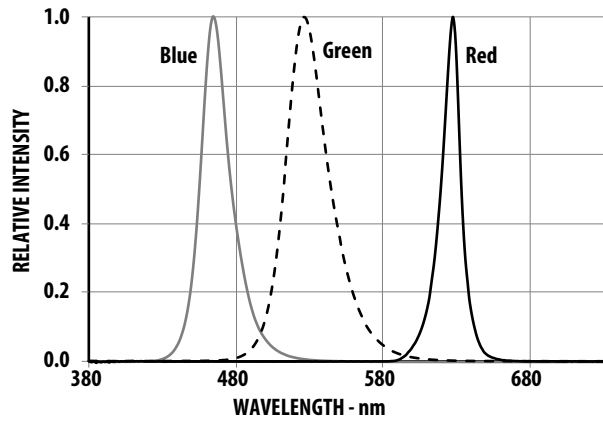

Figure 1. Relative Intensity vs. Wavelength

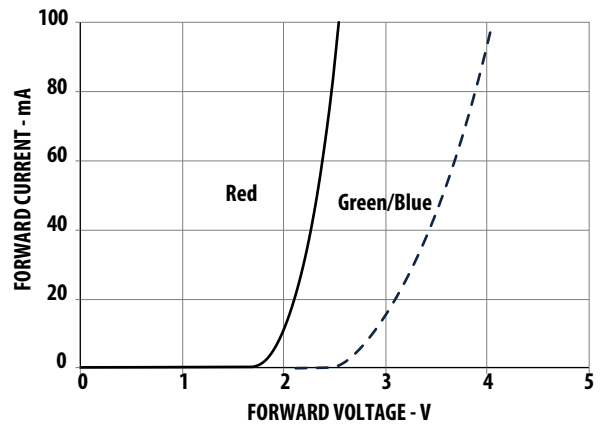

Figure 2. Forward Current -mA vs. Forward Voltage

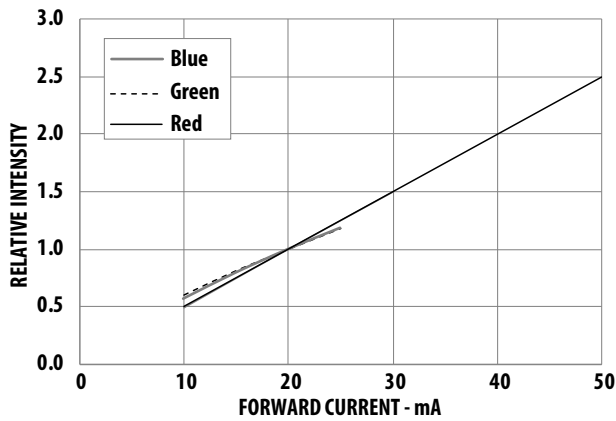

Figure 3. Relative Intensity vs. Forward Current

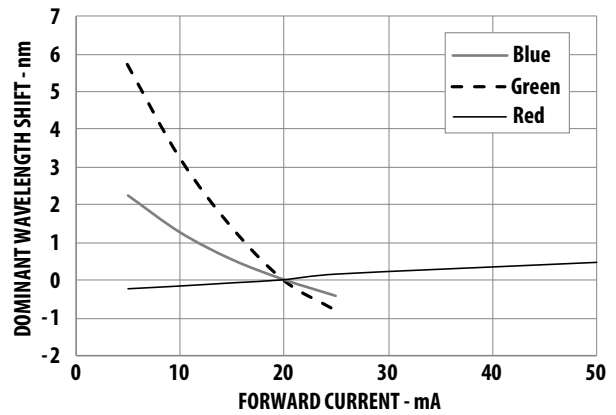

Figure 4. Dominant wavelength shift vs. Forward Current

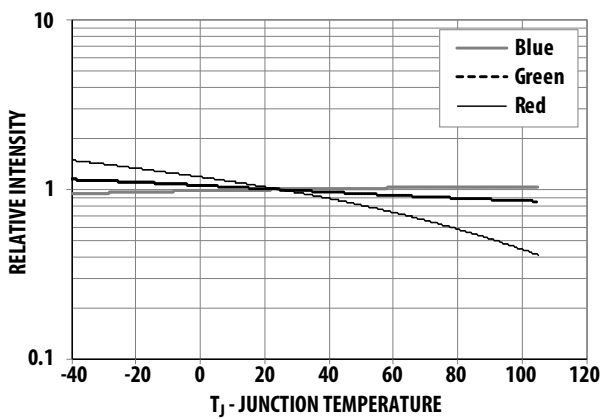

Figure 5. Relative Intensity vs. Junction Temperature

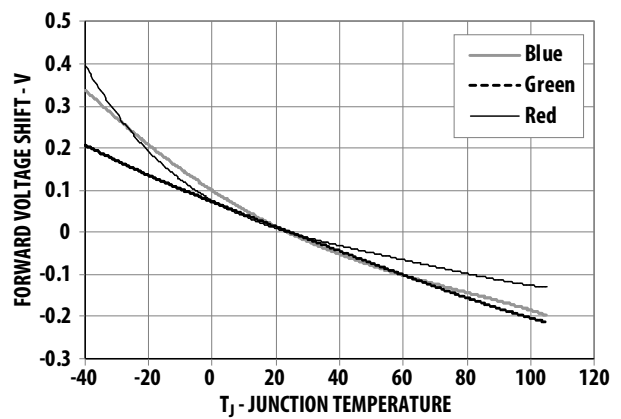

Figure 6. Forward Voltage vs. Junction Temperature

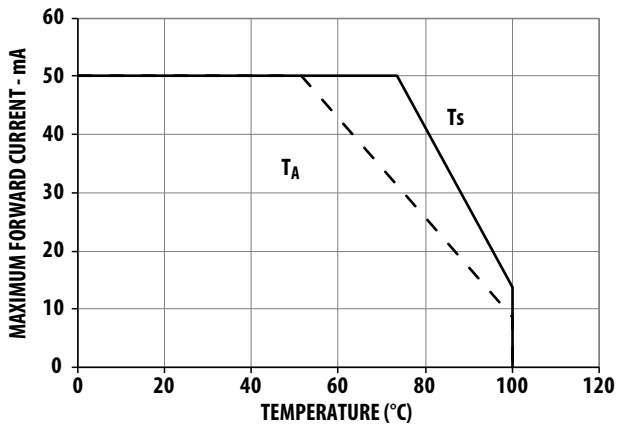

Figure 7. Maximum forward current vs. temperature for Red (1 chip on)

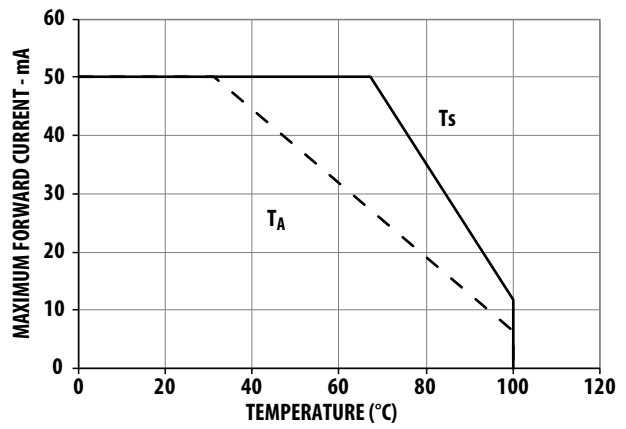

Figure 8. Maximum forward current vs. temperature for Red (3 chips on)

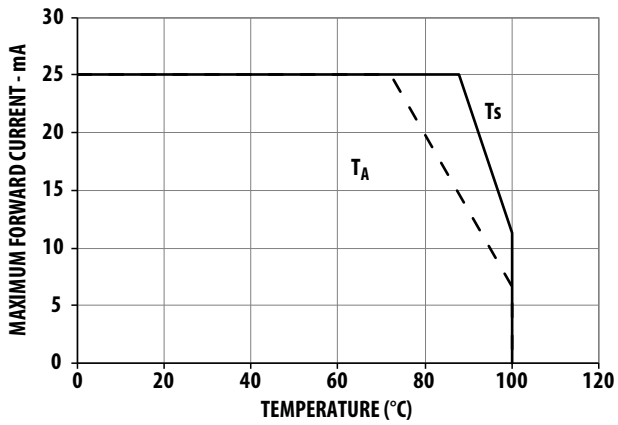

Figure 9. Maximum forward current vs. temperature for Green & Blue (1 chip on)

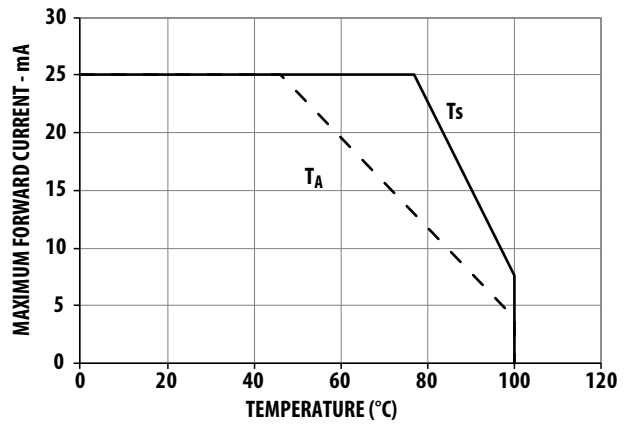
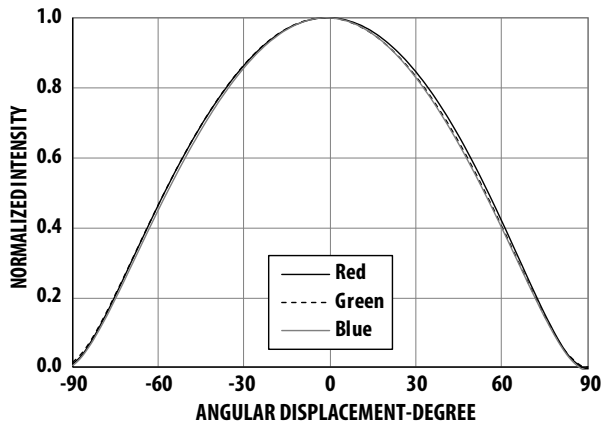

Figure 10. Maximum forward current vs. temperature for Green & Blue (3 chips on)

Note:

Maximum forward current graphs based on ambient temperature,  $T_A$  are with reference to thermal resistance  $R_{\theta J-A}$  as follows. For more details, see Precautionary Notes (4) .

Condition	Thermal resistance from LED junction to ambient, $R_{\theta J-A}$ ( $^{\circ}C/W$ )	
	Red	Green & Blue
1 chip on	450	410
3 chips on	630	690



Figures 11a. Radiation pattern along x-axis of the package

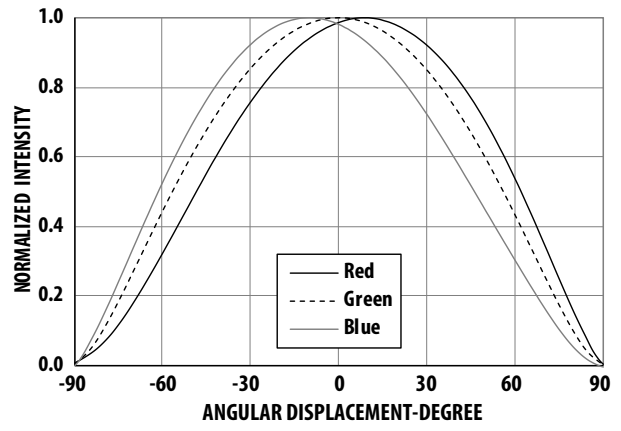

Figures 11b. Radiation pattern along y-axis of the package

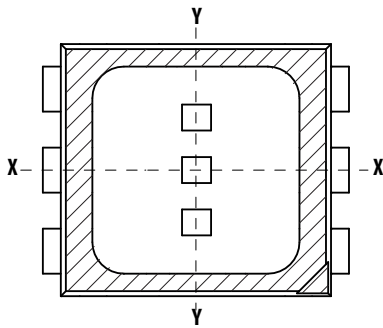

Figure 11c. Illustration of package axis for radiation pattern

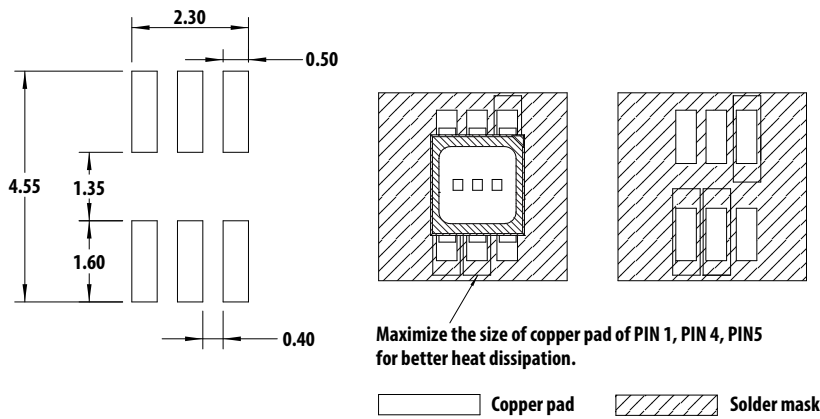

Figure 12. Recommended soldering land pattern

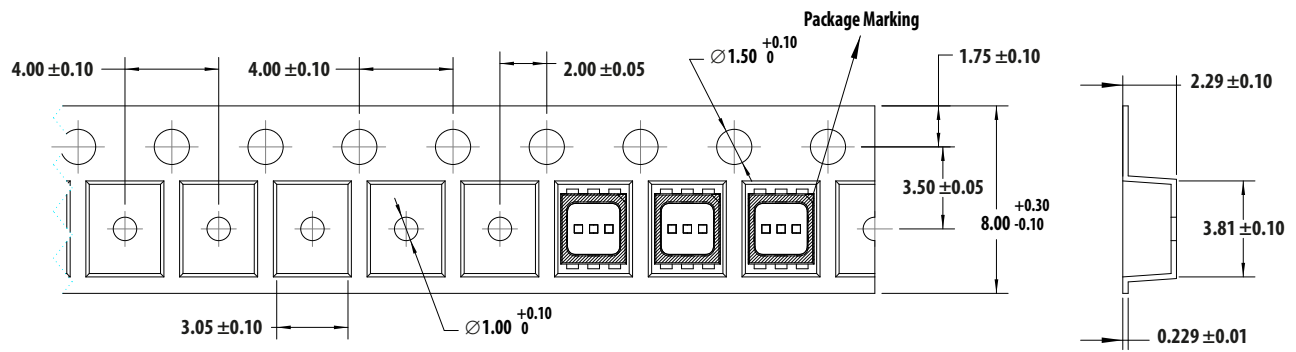

Figure 13. Carrier tape dimensions

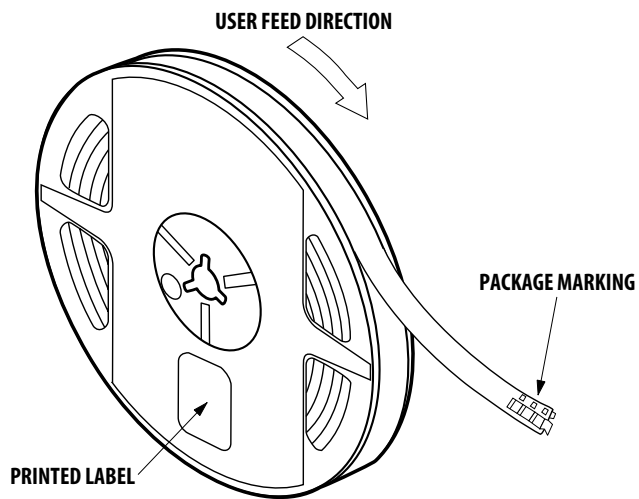

Figure 14. Reeling orientation

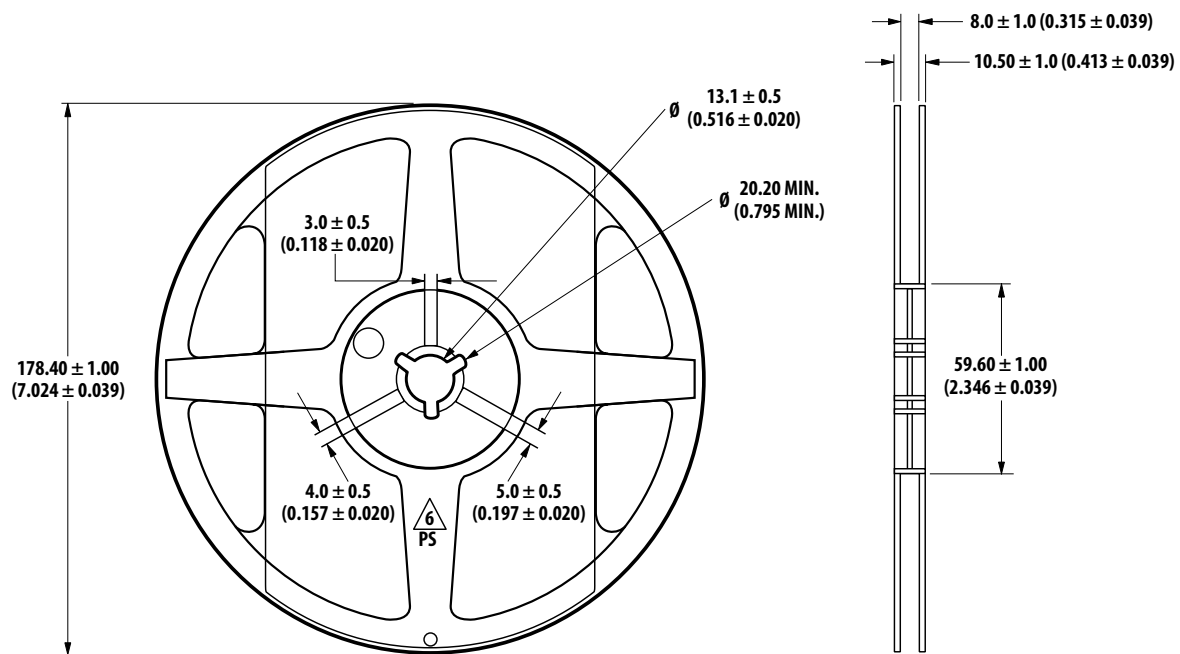

Figure 15. Reel dimensions



**Packing Label:**

**(i) Standard label (attached on moisture barrier bag)**

<p><b>AvAGO</b> TECHNOLOGIES STANDARD LABEL LS0002 RoHS Compliant Halogen Free e4 Max Temp 260C MSL3</p>	
(1P) Item: <b>Part Number</b> 	(Q) QTY: <b>Quantity</b> 
(1T) Lot: <b>Lot Number</b> 	CAT: <b>Intensity Bin</b> 
LPN: 	BIN: <b>Color Bin</b> 
(9D) MFG Date: <b>Manufacturing Date</b> 	
(P) Customer Item: 	
(V) Vendor ID: 	(9D) Date Code: <b>Date Code</b> 
DeptID: 	Made In: <b>Country of Origin</b> 

**Packing Label:**

**(ii) Baby label (attached on plastic reel)**

<p><b>AvAGO</b> TECHNOLOGIES BABY LABEL COSB 001B V0.0</p>	
(1P) PART #: <b>Part Number</b> 	QUANTITY: <b>Packing Quantity</b> 
(1T) LOT #: <b>Lot Number</b> 	(9D): DATE CODE: 
(9D)MFG DATE: <b>Manufacturing Date</b> 	
C/O: <b>Country of Origin</b> 	
(1T) TAPE DATE: 	D/C: <b>Date Code</b> VF: CAT: <b>INTENSITY BIN</b> BIN: <b>COLOR BIN</b>

**Example of luminous intensity (lv) bin information on label:**

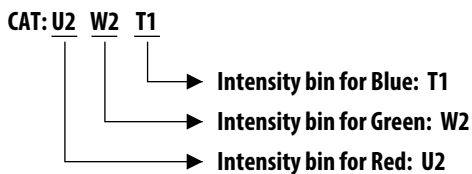

**Example of color bin information on label:**

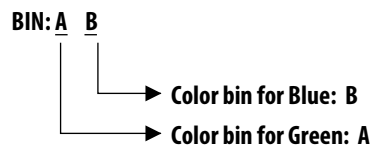

Note: There is no color bin ID for Red color as there is only 1 range, as stated in Table 4.

## Soldering

Recommended reflow soldering condition:

### (i) Leaded reflow soldering:

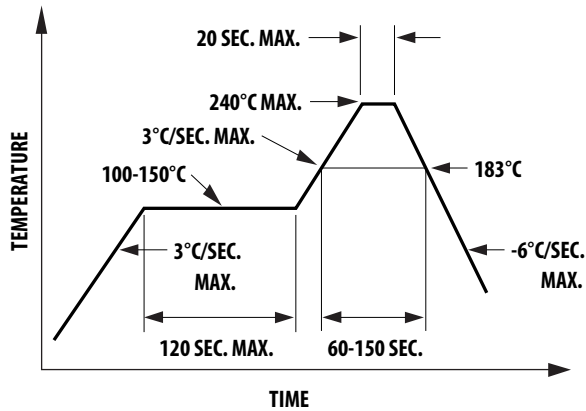

### (ii) Lead-free reflow soldering:

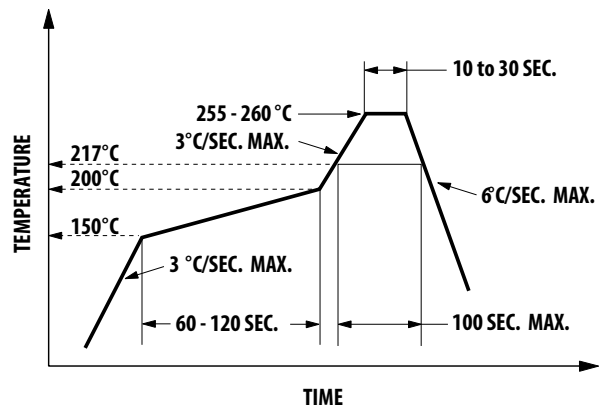

a. Reflow soldering must not be done more than 2 times. Do observe necessary precautions of handling moisture sensitive device as stated in the following section.

b. Recommended board reflow direction:

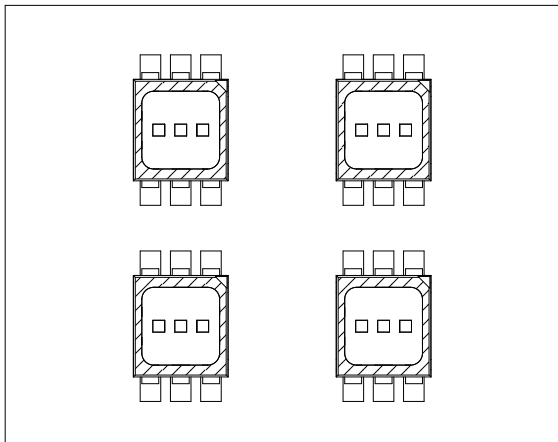

c. Do not apply any pressure or force on the LED during reflow and after reflow when the LED is still hot.  
d. It is preferred that you use reflow soldering to solder the LED. Use hand soldering for rework only if unavoidable but it must be strictly controlled to the following conditions:

- Soldering iron tip temperature = 320 °C max
- Soldering duration = 3 sec max
- Number of cycle = 1 only
- Power of soldering iron = 50 W max

e. Do not touch the LED body with hot soldering iron except the soldering terminals as it may cause damage to the LED.

f. For de-soldering, it is recommended that you use a double flat tip.

g. User is advised to confirm beforehand whether the functionality and performance of the LED is affected by hand soldering.

## PRECAUTIONARY NOTES

### 1. Handling precautions

The encapsulation material of the LED is made of silicone for better product reliability. Compared to epoxy encapsulant that is hard and brittle, silicone is softer and flexible. Special handling precautions need to be observed during assembly of silicone encapsulated LED products. Failure to comply might lead to damage and premature failure of the LED. Do refer to Application Note AN5288, Silicone Encapsulation for LED: *Advantages and Handling Precautions* for more information.

- a. Do not poke sharp objects into the silicone encapsulant. Sharp object like tweezers or syringes might apply excessive force or even pierce through the silicone and induce failures to the LED die or wire bond.
- b. Do not touch the silicone encapsulant. Uncontrolled force acting on the silicone encapsulant might result in excessive stress on the wire bond. The LED should only be held by the body.
- c. Do not stack assembled PCBs together. Use an appropriate rack to hold the PCBs.
- d. Surface of silicone material attracts dust and dirt easier than epoxy due to its surface tackiness. To remove foreign particles on the surface of silicone, a cotton bud can be used with isopropyl alcohol (IPA). During cleaning, rub the surface gently without putting much pressure on the silicone. Ultrasonic cleaning is not recommended.
- e. For automated pick and place, Avago has tested nozzle size below to be working fine with this LED. However, due to the possibility of variations in other parameters such as pick and place machine maker/model and other settings of the machine, customer is recommended to verify the nozzle selected will not cause damage to the LED.

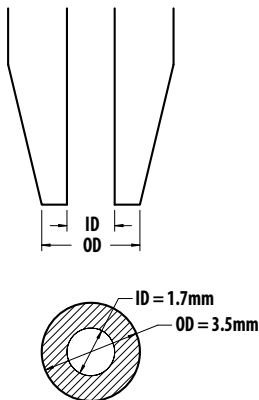

### 2. Handling of moisture sensitive device

This product has a Moisture Sensitive Level 3 rating per JEDEC J-STD-020. Refer to Avago Application Note AN5305, Handling of Moisture Sensitive Surface Mount Devices, for additional details and a review of proper handling procedures.

- a. Before use
  - An unopened moisture barrier bag (MBB) can be stored at  $<40^{\circ}\text{C}/90\% \text{RH}$  for 12 months. If the actual shelf life has exceeded 12 months and the humidity Indicator Card (HIC) indicates that baking is not required, then it is safe to reflow the LEDs per the original MSL rating.
  - It is recommended that the MBB not be opened prior to assembly (e.g. for IQC).
- b. Control after opening the MBB
  - The humidity indicator card (HIC) shall be read immediately upon opening of MBB.
  - The LEDs must be kept at  $<30^{\circ}\text{C} / 60\% \text{RH}$  at all times and all high temperature related processes including soldering, curing or rework need to be completed within 168 hours.
- c. Control for unfinished reel
  - Unused LEDs must be stored in a sealed MBB with desiccant or desiccator at  $<5\% \text{RH}$ .
- d. Control of assembled boards
  - If the PCB soldered with the LEDs is to be subjected to other high temperature processes, the PCB need to be stored in sealed MBB with desiccant or desiccator at  $<5\% \text{RH}$  to ensure that all LEDs have not exceeded their floor life of 168 hours.
- e. Baking is required if:
  - The HIC indicator is not BROWN at 10% and is AZURE at 5%.
  - The LEDs are exposed to condition of  $>30^{\circ}\text{C} / 60\% \text{RH}$  at any time.
  - The LED floor life exceeded 168hrs.

The recommended baking condition is:  $60 \pm 5^{\circ}\text{C}$  for 20hrs

Baking should only be done once.
- f. Storage
  - The soldering terminals of these Avago LEDs are silver plated. If the LEDs are being exposed in ambient environment for too long, the silver plating might be oxidized and thus affecting its solderability performance. As such, unused LEDs must be kept in sealed MBB with desiccant or in desiccator at  $<5\% \text{RH}$ .

### 3. Application precautions

- Drive current of the LED must not exceed the maximum allowable limit across temperature as stated in the datasheet. Constant current driving is recommended to ensure consistent performance.
- LED is not intended for reverse bias. Do use other appropriate components for such purpose. When driving the LED in matrix form, it is crucial to ensure that the reverse bias voltage is not exceeding the allowable limit of the LED.
- Do not use the LED in the vicinity of material with sulfur content, in environment of high gaseous sulfur compound and corrosive elements. Examples of material that may contain sulfur are rubber gasket, RTV (room temperature vulcanizing) silicone rubber, rubber gloves etc. Prolonged exposure to such environment may affect the optical characteristics and product life.
- Avoid rapid change in ambient temperature especially in high humidity environment as this will cause condensation on the LED.
- Although the LED is rated as IPx6 according to IEC60529: Degree of protection provided by enclosure, the test condition may not represent actual exposure during application. If the LED is intended to be used in outdoor or harsh environment, the LED must be protected against damages caused by rain water, dust, oil, corrosive gases, external mechanical stress etc.

### 4. Thermal management

Optical, electrical and reliability characteristics of LED are affected by temperature. The junction temperature ( $T_J$ ) of the LED must be kept below allowable limit at all times.  $T_J$  can be calculated as below:

$$T_J = T_A + R_{\theta J-A} \times I_F \times V_{Fmax}$$

where;

$T_A$  = ambient temperature [°C]

$R_{\theta J-A}$  = thermal resistance from LED junction to ambient [°C/W]

$I_F$  = forward current [A]

$V_{Fmax}$  = maximum forward voltage [V]

The complication of using this formula lies in  $T_A$  and  $R_{\theta J-A}$ . Actual  $T_A$  is sometimes subjective and hard to determine.  $R_{\theta J-A}$  varies from system to system depending on design and is usually not known.

Another way of calculating  $T_J$  is by using solder point temperature  $T_S$  as shown below:

$$T_J = T_S + R_{\theta J-S} \times I_F \times V_{Fmax}$$

where;

$T_S$  = LED solder point temperature as shown in illustration below [°C]

$R_{\theta J-S}$  = thermal resistance from junction to solder point [°C/W]

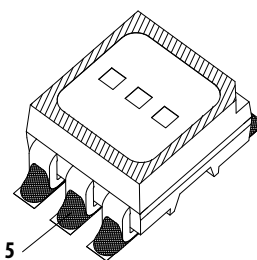

$T_S$  can be measured easily by mounting a thermocouple on the soldering joint as shown in illustration above, while  $R_{\theta J-S}$  is provided in the datasheet. User is advised to verify the  $T_S$  of the LED in the final product to ensure that the LEDs are operated within all maximum ratings stated in the datasheet.

### 5. Eye safety precautions

LEDs may pose optical hazards when in operation. It is not advisable to view directly at operating LEDs as it may be harmful to the eyes. For safety reasons, use appropriate shielding or personal protective equipments.

### 6. Disclaimer

Avago's products are not specifically designed, manufactured or authorized for sale as parts, components or assemblies for the planning, construction, maintenance or direct operation of a nuclear facility or for use in medical devices or applications. Customer is solely responsible, and waives all rights to make claims against Avago or its suppliers, for all loss, damage, expense or liability in connection with such use.

For product information and a complete list of distributors, please go to our web site: [www.avagotech.com](http://www.avagotech.com)

Avago, Avago Technologies, and the A logo are trademarks of Avago Technologies in the United States and other countries. Data subject to change. Copyright © 2005-2014 Avago Technologies. All rights reserved. AV02-3793EN - August 7, 2014

**AVAGO**  
TECHNOLOGIES