

PLEASE CHECK WWW.MOLEX.COM FOR LATEST PART INFORMATION

Part Number: [03-06-2092](#)
Status: **Active**
Overview: Standard .062" Pin and Socket Power Connectors
Description: 1.57mm Diameter Standard .062" Pin and Socket Plug Housing, 9 Circuits, without Mounting Ears

Documents:

[3D Model](#) [Packaging Specification PK-1625-003 \(PDF\)](#)
[Drawing \(PDF\)](#) [RoHS Certificate of Compliance \(PDF\)](#)
[Product Specification PS-02-06 \(PDF\)](#)

Agency Certification

CSA LR19980
 UL E29179

General

Product Family Crimp Housings
 Series [1625](#)
 Application Power, Wire-to-Wire
 Comments Polarized to Mating Part
 Overview [Standard .062" Pin and Socket Power Connectors](#)
 Product Name Standard .062"
 UPC 800753615274

Physical

Breakaway No
 Circuits (maximum) 9
 Circuits Detail 3x3
 Color - Resin Natural
 Flammability 94V-2
 Gender Plug
 Glow-Wire Compliant No
 Keying to Mating Part None
 Lock to Mating Part Yes
 Material - Resin Nylon
 Net Weight 1.807/g
 Number of Rows 3
 Packaging Type Bag
 Panel Mount No
 Pitch - Mating Interface 3.68mm
 Pitch - Termination Interface 3.68mm
 Polarized to Mating Part Yes
 Stackable No
 Temperature Range - Operating -40°C to +105°C

Electrical

Current - Maximum per Contact 5A

Material Info

Old Part Number 1625-9P1

Reference - Drawing Numbers

Packaging Specification PK-1625-003
 Product Specification PS-02-06
 Sales Drawing SD-1625-9*

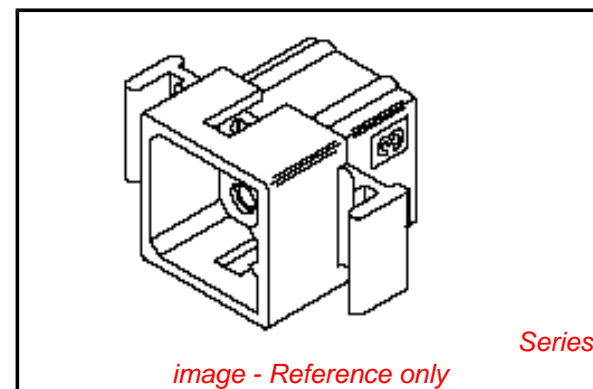

EU RoHS

ELV and RoHS Compliant
REACH SVHC Contains SVHC: No
Low-Halogen Status Low-Halogen

China RoHS



Need more information on product environmental compliance?

Email productcompliance@molex.com
 For a multiple part number RoHS Certificate of Compliance, [click here](#)

Please visit the [Contact Us](#) section for any non-product compliance questions.

Search Parts in this Series

[1625Series](#)

Mates With

[03-06-1092](#)

Use With

Female Crimp Terminals [1561](#) , [4559](#) , [4529](#) , [2190](#) , [2189](#) , [1787](#) , [1855](#) . Male Crimp Terminals [1560](#) , [1786](#) , [1854](#) . [1778](#) Male PC Tail Terminals. [1779](#) Female PC Tail Terminals

This document was generated on 10/14/2014

PLEASE CHECK WWW.MOLEX.COM FOR LATEST PART INFORMATION