

**PLEASE CHECK WWW.MOLEX.COM FOR LATEST PART INFORMATION**

**Part Number:** [18-12-1222](#)  
**Status:** **Active**  
**Description:** 3.18mm Diameter HCS-125 Pin and Socket Crimp Terminal, Series 2047, Female, with Tin (Sn) Plated Brass Contact, 16-18 AWG, Bag

**Documents:**

[Drawing \(PDF\)](#) [RoHS Certificate of Compliance \(PDF\)](#)  
[Product Specification PSX-42179 \(PDF\)](#)

**General**

Product Family	Crimp Terminals
Series	<a href="#">2047</a>
Application	Power
Crimp Quality Equipment	Yes
MolexKits	Yes
Packaging Alternative	<a href="#">18-12-1221</a> (Reel)
Product Name	HCS-125
UPC	800753594418

**Physical**

Gender	Female
Material - Metal	Brass
Material - Plating Mating	Tin
Material - Plating Termination	Tin
Net Weight	0.641/g
Packaging Type	Bag
Plating min - Mating	0.508µm
Plating min - Termination	0.508µm
Termination Interface: Style	Crimp or Compression
Wire Insulation Diameter	3.05mm max.
Wire Size AWG	16, 18
Wire Size mm <sup>2</sup>	N/A

**Material Info**

Old Part Number [2047-1\(P901\)L](#)

**Reference - Drawing Numbers**

Product Specification [PSX-42179](#)  
 Sales Drawing [SD-2047-1\\*](#)

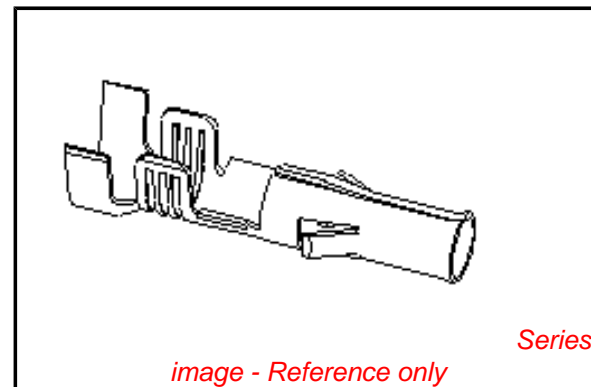

**EU RoHS**

**ELV and RoHS Compliant**  
**REACH SVHC Contains SVHC: No**  
**Low-Halogen Status Low-Halogen**

**China RoHS**



**Need more information on product environmental compliance?**

Email [productcompliance@molex.com](mailto:productcompliance@molex.com)  
 For a multiple part number RoHS Certificate of Compliance, [click here](#)

Please visit the [Contact Us](#) section for any non-product compliance questions.

**Search Parts in this Series**

[2047Series](#)

**Mates With**

[1900 Series](#), [2046 Series](#), [42554 Series](#)

**Use With**

[42179 Receptacle](#)

**Application Tooling | [FAQ](#)**

*Tooling specifications and manuals are found by selecting the products below. Crimp Height Specifications are then contained in the Application Tooling Specification document.*

**Global**

Description	Product #
Hand Crimp Tool	<a href="#">0638191100</a>
Extractor Tool for .093 and HCS-125 Product Series	<a href="#">0638240200</a>

This document was generated on 10/08/2014

**PLEASE CHECK [WWW.MOLEX.COM](http://WWW.MOLEX.COM) FOR LATEST PART INFORMATION**