

Features

- Compliant with IEEE802.3 standards
- Designed for 10/100 Base-Tx and PoE
- RoHS compliant*

Applications

- VoIP
- Power over Ethernet - PoE

SM51108PEL LAN 10/100 Base-Tx VoIP Transformer (PoE) Modules

Electrical Specifications @ 25 °C

Turns Ratio ($\pm 3\%$) 1CT:1CT
OCL (@ 100 kHz, 0.1 V, 8 mA, DC Bias) 350 μ H min.
Leakage Inductance (@ 100 kHz, 0.1 V with 1-2-3-6-7-8 Short) 0.5 μ H max.
Cw/w @ 100 kHz, 0.1 V 35 pF max.
DCR	
1-3 = 6-8 0.8 ohm max.
9-11 = 14-16 1.1 ohm max.
Insertion Loss	
1-100 MHz -1.2 dB max.
Return Loss (@ 100 Ohms)	
1-30 MHz -16 dB min.
40 MHz -14 dB min.
50 MHz -13 dB min.
60-80 MHz -12 dB min.
Cross Talk	
60 MHz -40 dB min.
100 MHz -35 dB min.
DCMRR	
30 MHz -43 dB min.
60 MHz -37 dB min.
100 MHz -33 dB min.
PoE Current Up to 320 mA
Hi-Pot Test 1500 Vrms
Operating Temperature Range -40 °C to +85 °C
Storage Temperature Range -25 °C to +125 °C

Packaging Specifications

Tape & Reel 600 pcs./reel

How To Order

SM51108 P E L

Model _____
 Construction _____
 P = Potted
 Packaging _____
 E = Tape and Reel (600 pcs./reel)
 Termination _____
 L = Tin (RoHS Compliant)

Product Dimensions

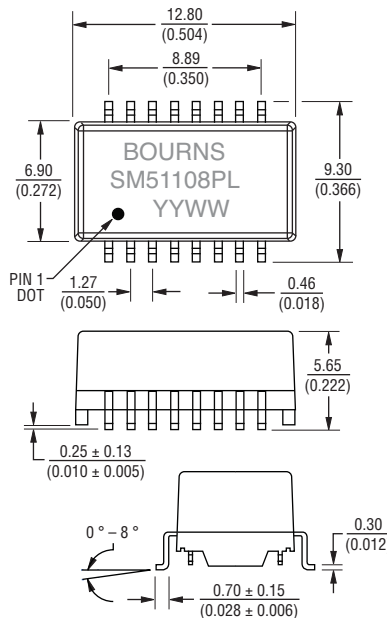

Recommended Layout

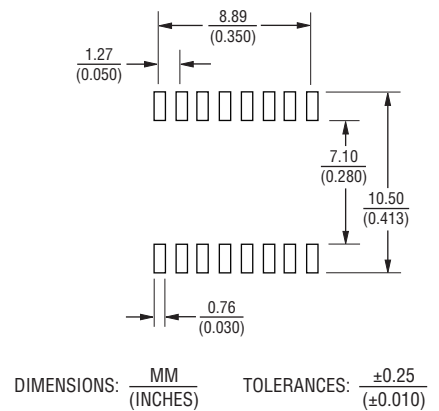

Electrical Schematic

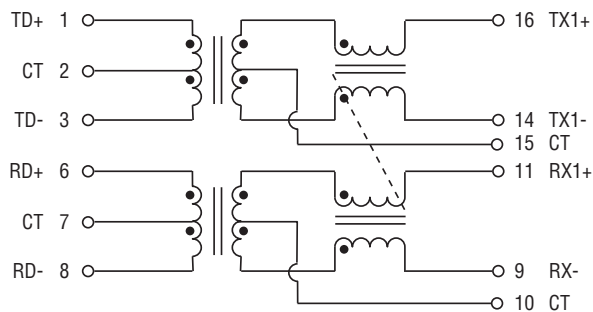

BOURNS®

Asia-Pacific: Tel: +886-2 2562-4117 • Fax: +886-2 2562-4116

EMEA: Tel: +36 88 520 390 • Fax: +36 88 520 211

The Americas: Tel: +1-951 781-5500 • Fax: +1-951 781-5700

www.bourns.com

*RoHS Directive 2002/95/EC Jan. 27, 2003 including annex and RoHS Recast 2011/65/EU June 8, 2011.

Specifications are subject to change without notice.

The device characteristics and parameters in this data sheet can and do vary in different applications and actual device performance may vary over time. Users should verify actual device performance in their specific applications.

SM51108PEL LAN 10/100 Base-Tx VoIP Transformer (PoE) Modules



Soldering Profile

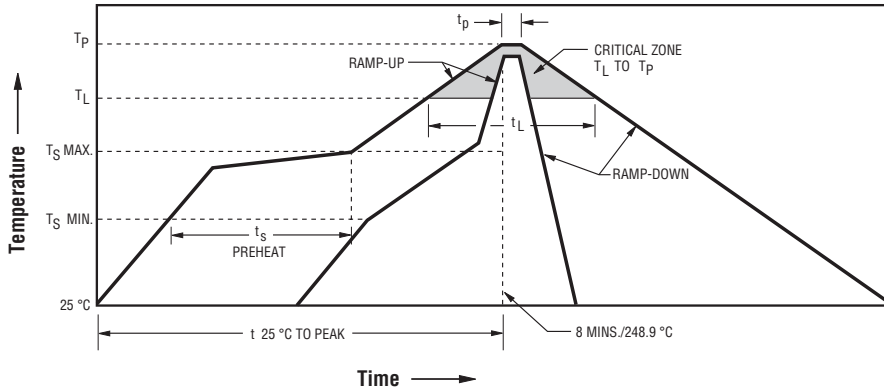

- Ramp-up rate = 3 °C/sec. max.
- Ramp-down rate = 6 °C/sec. max.
- T_L = 217 °C
- t_L = 60-150 sec.
- T_P = 250 ±30 °C
- Time within 5 °C of actual Peak Temp (t_p) = 20~40 sec.
- T_S min = 150 °C
- T_S max = 200 °C
- T_S min to T_S max = 60-180 sec., 25 °C to Peak Temperature = 8 min. max.

Refer to IPC/JEDEC J-STD020D standard.

Packaging Specifications

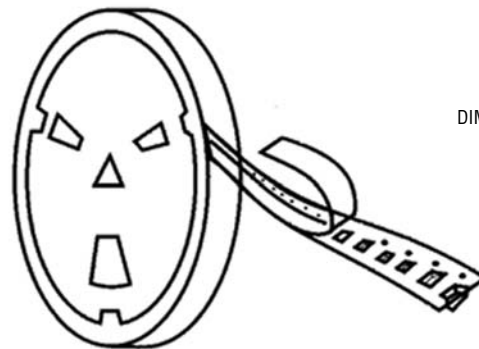
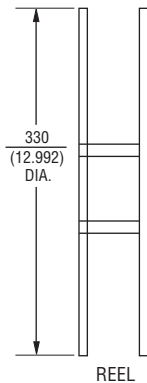

DIMENSIONS: $\frac{\text{MM}}{\text{(INCHES)}}$

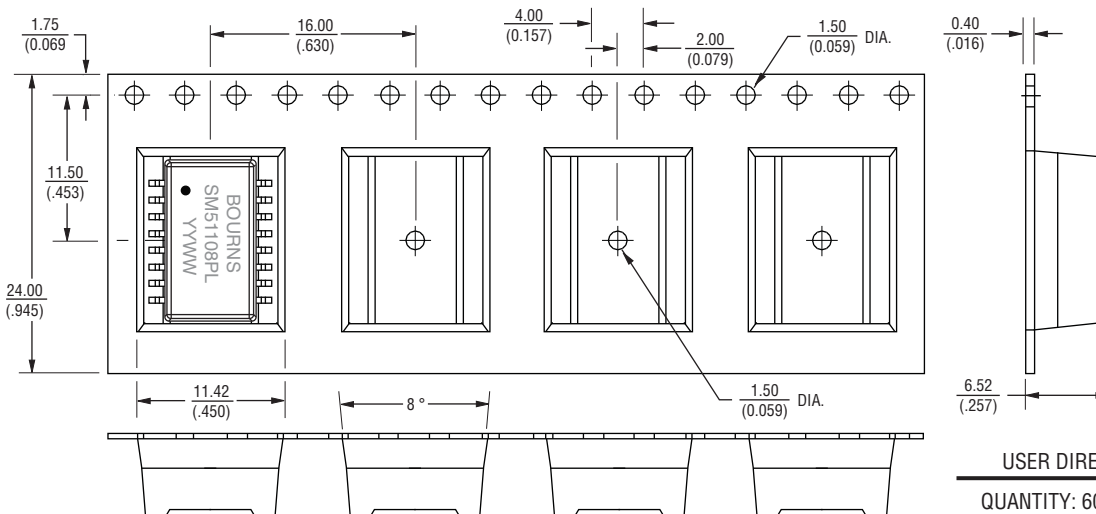

USER DIRECTION OF FEED →
QUANTITY: 600 PCS. PER REEL