

Scavenger Transmitter Module

STM 330 / STM 331 / STM 330C / STM 332U / STM 333U

October 9, 2014



Observe precautions! Electrostatic sensitive devices!

Patent protected:

WO98/36395, DE 100 25 561, DE 101 50 128,
WO 2004/051591, DE 103 01 678 A1, DE 10309334,
WO 04/109236, WO 05/096482, WO 02/095707,
US 6,747,573, US 7,019,241

REVISION HISTORY

The following major modifications and improvements have been made to the first version of this document:

No	Major Changes
0.55	Initial version
0.90	New drawings added; Agency certifications added; Charging circuitry modified; editorial changes
0.91	Drawings updated
0.95	Parameters of A/D converter corrected and specified in more detail; Charging circuitry modified.
0.99	Pin for connection of backup battery changed; ICHAR modified in 2.4 and 2.5; section 3.5 inserted; drawings updated
1.00	Block diagram and pin description modified.
1.01	Table in 2.11 modified
1.02	Remark added in 3.5; additional remarks in 2.11; label information modified in chapter 5; Shelf life added in 1.4; supply voltage for programming added in 2.2; Conducted output power replaced by radiated output power in 1.2; programming interface added in 2.3.2; other editorial changes
1.03	Support for HSM 100 humidity sensor module added
1.04	Specification of shelf life improved; figure added in 3.3.1; Chapter Related Documents added.
1.05	STM 331 with helix antenna added (naming + helix antenna description), hints to update module via STMSEN
1.10	Product variants STM 332U and STM 333U added
1.15	Included PCB Drawings of STM 332U / STM 333U
1.20	Added information on connector type

Published by EnOcean GmbH, Kolpingring 18a, 82041 Oberhaching, Germany
www.enocean.com, info@enocean.com, phone ++49 (89) 6734 6890

© EnOcean GmbH
 All Rights Reserved

Important!

This information describes the type of component and shall not be considered as assured characteristics. No responsibility is assumed for possible omissions or inaccuracies. Circuitry and specifications are subject to change without notice. For the latest product specifications, refer to the EnOcean website: <http://www.enocean.com>.

As far as patents or other rights of third parties are concerned, liability is only assumed for modules, not for the described applications, processes and circuits.

EnOcean does not assume responsibility for use of modules described and limits its liability to the replacement of modules determined to be defective due to workmanship. Devices or systems containing RF components must meet the essential requirements of the local legal authorities.

The modules must not be used in any relation with equipment that supports, directly or indirectly, human health or life or with applications that can result in danger for people, animals or real value.

Components of the modules are considered and should be disposed of as hazardous waste. Local government regulations are to be observed.

Packing: Please use the recycling operators known to you.

TABLE OF CONTENT

1	RELATED DOCUMENTS	5
2	GENERAL DESCRIPTION	6
	2.1 Basic functionality	6
	2.2 Technical data	7
	2.3 Physical dimensions	7
	2.3.1 Mechanical Outline – STM 330 / STM 331 / STM 330C	8
	2.3.2 Mechanical Outline – STM 332U / STM 333U	9
	2.4 Environmental conditions	10
	2.5 Ordering Information	10
3	FUNCTIONAL DESCRIPTION	11
	3.1 Simplified firmware flow chart	11
	3.2 Simplified device block diagram	12
	3.3 Pin out	13
	3.4 Pin description and operational characteristics	14
	3.4.1 GPIO supply voltage	15
	3.4.2 Analog and digital inputs	16
	3.4.3 Temperature sensor	16
	3.4.4 Programming Interface	17
	3.5 Absolute maximum ratings (non operating)	18
	3.6 Maximum ratings (operating)	18
	3.7 Power management and voltage regulators	18
	3.8 Configuration	19
	3.8.1 Configuration via pins	19
	3.8.2 Configuration via serial interface	20
	3.9 Radio telegram	22
	3.9.1 Normal operation	22
	3.9.2 Teach-in telegram	22
	3.10 Transmit timing	22
	3.11 Charging circuitry	23
	3.12 Energy consumption	23
4	APPLICATIONS INFORMATION	25
	4.1 Using the WAKE pins	25
	4.2 Temperature sensor	26
	4.3 Set point control and occupancy button	26
	4.4 Combination with humidity sensor module HSM 100	26
	4.5 Antenna layout	27
	4.5.1 Whip antenna (STM 330 / STM 330C / STM 332U)	27
	4.5.2 Helical antenna (STM 331 / STM 333U)	28
	4.6 Mounting STM 33x into a housing	29
	4.7 Transmission range	30



- 5 AGENCY CERTIFICATIONS 31
 - 5.1 CE Approval 31
 - 5.2 FCC (United States) certification 32
 - 5.2.1 STM 330C / 332U / 333U LIMITED MODULAR APPROVAL 32
 - 5.2.2 STM 330C FCC Grant 34
 - 5.2.3 STM 332U / STM 333U FCC Grant 35
 - 5.2.4 FCC Regulatory Statements 36
 - 5.3 IC (Industry Canada) certification 37
 - 5.3.1 STM 330C IC Technical Approval Certificate 38
 - 5.3.2 STM 332U / STM 333U IC Technical Approval Certificate 39
 - 5.3.3 Industry Canada Regulatory Statements 40
- 6 Label Information 40

1 RELATED DOCUMENTS

STM 33x products are available in several frequency, antenna and button position variants:

- STM 330 (868.3MHz, whip antenna, vertical oriented LRN button)
- STM 331 (868.3MHz, helical antenna, vertical oriented LRN button)
- STM 330C (315.0MHz, whip antenna, vertical oriented LRN button)
- STM 332U (902.875MHz, whip antenna, side oriented LRN button)
- STM 333U (902.875MHz, helical antenna, side oriented LRN button)

This document describes operation of STM 330, STM 331, 330C, STM 332U, STM 333U modules with their built-in firmware.

If you want to write own firmware running on the integrated micro controller or need more detailed information on the Dolphin core please also refer to Dolphin Core Description and Dolphin API Documentation at: <http://www.enocean.com/en/knowledge-base/>

If you want to connect other generic sensors to STM 33x (former STM 310 applications), you can download STEMSEN Software from following link:

<http://www.enocean.com/en/download/>

Module can be programmed via

- EOP 300 programmer & EVA 330 developer board or
- EOP 350 programmer

For mechanical integration please refer to our 3D drawings found at

http://www.enocean.com/en/enocean_modules/stm-330/

If you want to add a humidity sensor please refer to the HSM 100 data sheet at

http://www.enocean.com/en/enocean_modules/stm-330/

In addition we recommend following our [application notes](#), in particular

- AN102: Antenna Basics – Basic Antenna Design Considerations for EnOcean based Products

2 GENERAL DESCRIPTION

2.1 Basic functionality

The extremely power saving RF transmitter module family STM 33x of EnOcean is optimized for realization of wireless and maintenance free temperature sensors, or room operating panels including set point dial and occupancy button. It requires only a minimum number of external components and provides an integrated and calibrated temperature sensor.

Power supply is provided by a small pre-installed solar cell, an external energy harvester, or an external 3 V backup battery.

An energy storage element is installed in order to bridge periods with no supply from the energy harvester. The module provides a user configurable cyclic wake up.

After wake up, the internal microcontroller reads the status of the temperature sensor and optional set point dial. A radio telegram will be transmitted in case of a significant change of measured temperature or set point values or if the external occupancy button is pressed. In case of no relevant input change, a redundant retransmission signal is sent after a user configurable number of wake-ups to announce all current values.

In addition to the cyclic wake-up, a wake up can be triggered externally using the input for the occupancy button or the internal LRN button.

The firmware can be configured to use different EEPs according to the availability set point dial and occupancy button.

Features with built-in firmware

- Pre-installed solar cell
- On-board energy storage and charging circuit
- On-board LRN button
- On-board TX indicator LED
- Calibrated internal temperature sensor
- On board connector for external occupancy button and set point dial input
- Configurable wake-up and transmission cycle
- Wake-up via Wake pins or LRN button
- Support for humidity sensor module HSM 100

Features accessible via API

Using the Dolphin API library it is possible to write custom firmware for the module. The API provides:

- Integrated 16 MHz 8051 CPU with 32 kB FLASH and 2 kB SRAM
- Integrated temperature sensor
- Various power down and sleep modes down to typ. 0.2 μ A current consumption
- Up to 13 configurable I/Os
- 10 bit ADC, 8 bit DAC



2.2 Technical data

Antenna	whip antenna (STM 330 / STM 330C / STM 332U) helical antenna (STM 331, STM 333U)
Frequency	315.0 MHz (STM 330C) / 868.3 MHz (STM 330 / STM 331) / 902.875MHz (STM 332U / STM 333U)
Radio Standard	EnOcean 902 MHz / 868 MHz / 315 MHz
Data rate/Modulation type	125 kbps/ASK(868MHz/315MHz), FSK(902MHz)
Radiated Output Power	STM 330: +8 dBm ¹ (EIRP) ± 2.5 dB ² STM 331: +5 dBm ¹ (EIRP) ± 2.5 dB ² STM 330C: +92 dBµV/m ¹ ± 2 dB ² STM 332U: +101 dBµV/m ¹ ± 2 dB ² STM 333U: +99 dBµV/m ¹ ± 2 dB ²
Power Supply @ VDD	Pre-installed solar cell Illumination 50-100000 lux 2.1 V–5.0 V, 2.6 V needed for start-up
Initial operation time in darkness @ 25°C	typ. 4 days, min. 60 hours if energy storage fully charged, wake-up every 100 s, transmission of telegram every 1000 s on average ³
Operation start up time with empty energy store	typ. 2.5 min @ 400 lux / 25 °C incandescent or fluorescent light
Input Channels	Internal: temperature sensor, LRN button External: occupancy button, set point dial, HSM 100
Temperature sensor	Measurement range 0-40 °C, resolution 0.16 K Accuracy typ. ±0.5 K between 17 °C and 27 °C typ. ±1 K between 0 °C and 40 °C
EnOcean Equipment Profiles	configurable EEPs: A5-02-05 (default), A5-10-05, A5-10-03 and with HSM 100: A5-04-01, A5-10-10, A5-10-12
Connector	20 pins, grid 1.27 mm, □ 0.4 mm
Radio Regulations	R&TTE EN 300 220 (STM 330 / 331) FCC CFR-47 Part 15 (STM 330C, STM 332U / 333U)

2.3 Physical dimensions

PCB dimensions	43±0.2 x 16±0.3 x 1±0.1 mm
Module height	8 mm
Weight	4.5 g (STM 33x), 4.9 g (STM 330C), 4.5 g (STM 332U), 4.5 g (STM 333U)

¹ Measured in test laboratory, measurement uncertainty 2.7 dB

² Tolerance of measurement in production at 50 Ω

³ Full performance of the PAS614L energy storage is achieved after several days of operation (up to two weeks) at good illumination level. Performance degrades over life time, especially if energy storage is exposed to higher temperatures. Each 10 K drop in temperature doubles the expected life span.

STM 330 / STM 331 / STM 330C / STM 332U / STM 333U

2.3.1 Mechanical Outline – STM 330 / STM 331 / STM 330C

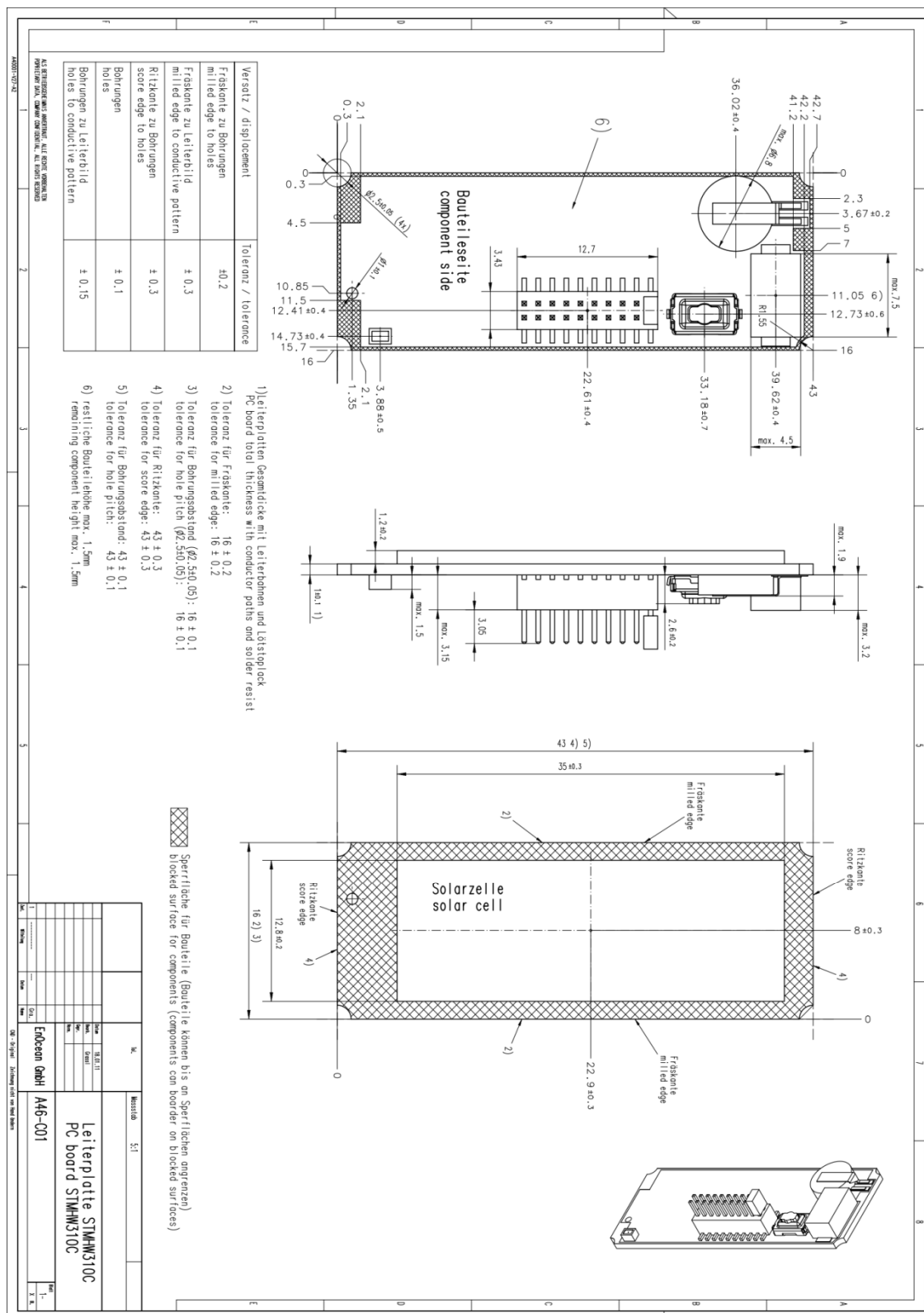

STM 330 / STM 331 / STM 330C / STM 332U / STM 333U

2.3.2 Mechanical Outline – STM 332U / STM 333U

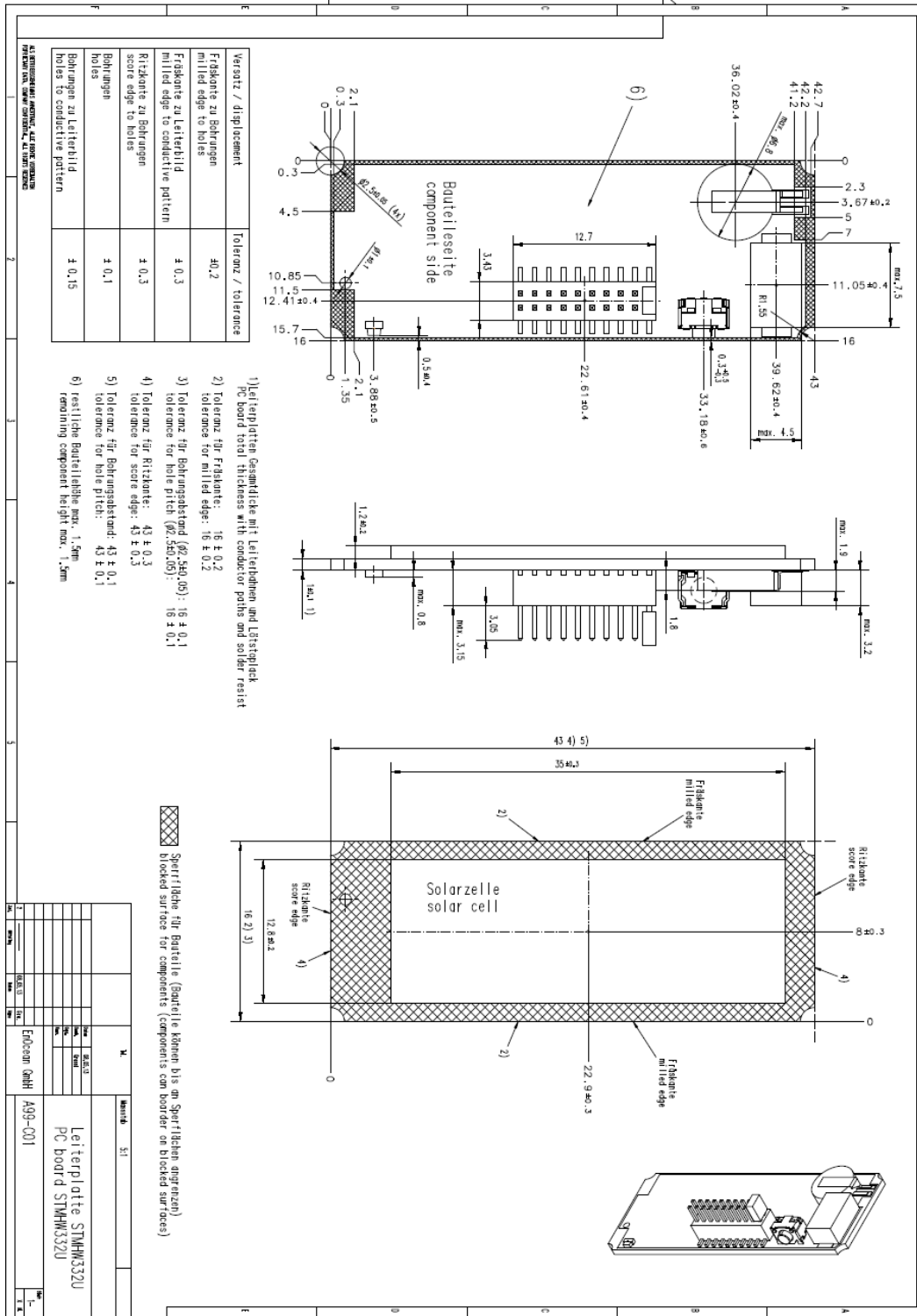

2.4 Environmental conditions

Operating temperature	-20 °C ... +60 °C
Storage temperature	-20 °C ... +60 °C, recommended ⁴ : +10 °C...+30 °C, <60%r.h.
Shelf life (in absolute darkness)	36 months after delivery ⁵
Humidity	0% ... 93% r.h., non-condensing



The module shall not be placed on conductive materials, to prevent discharge of the internal energy storages⁵. Even materials such as conductive foam (ESD protection) may have negative impact.

2.5 Ordering Information

Type	Ordering Code	Frequency
STM 330	S3001-D330	868.3 MHz
STM 331	S3001-D331	868.3 MHz
STM 330C	S3031-D330	315.0 MHz
STM 332U	S3051-D332	902.875 MHz
STM 333U	S3051-D333	902.875 MHz

⁴ Recommended for maximum life of energy storage capacitor

⁵ Deep discharge of the PAS614L energy storage leads to degradation of performance. Therefore products have to be taken into operation after 36 months. At least the PAS614L needs to be recharged to 2.1 V.

3 FUNCTIONAL DESCRIPTION

3.1 Simplified firmware flow chart

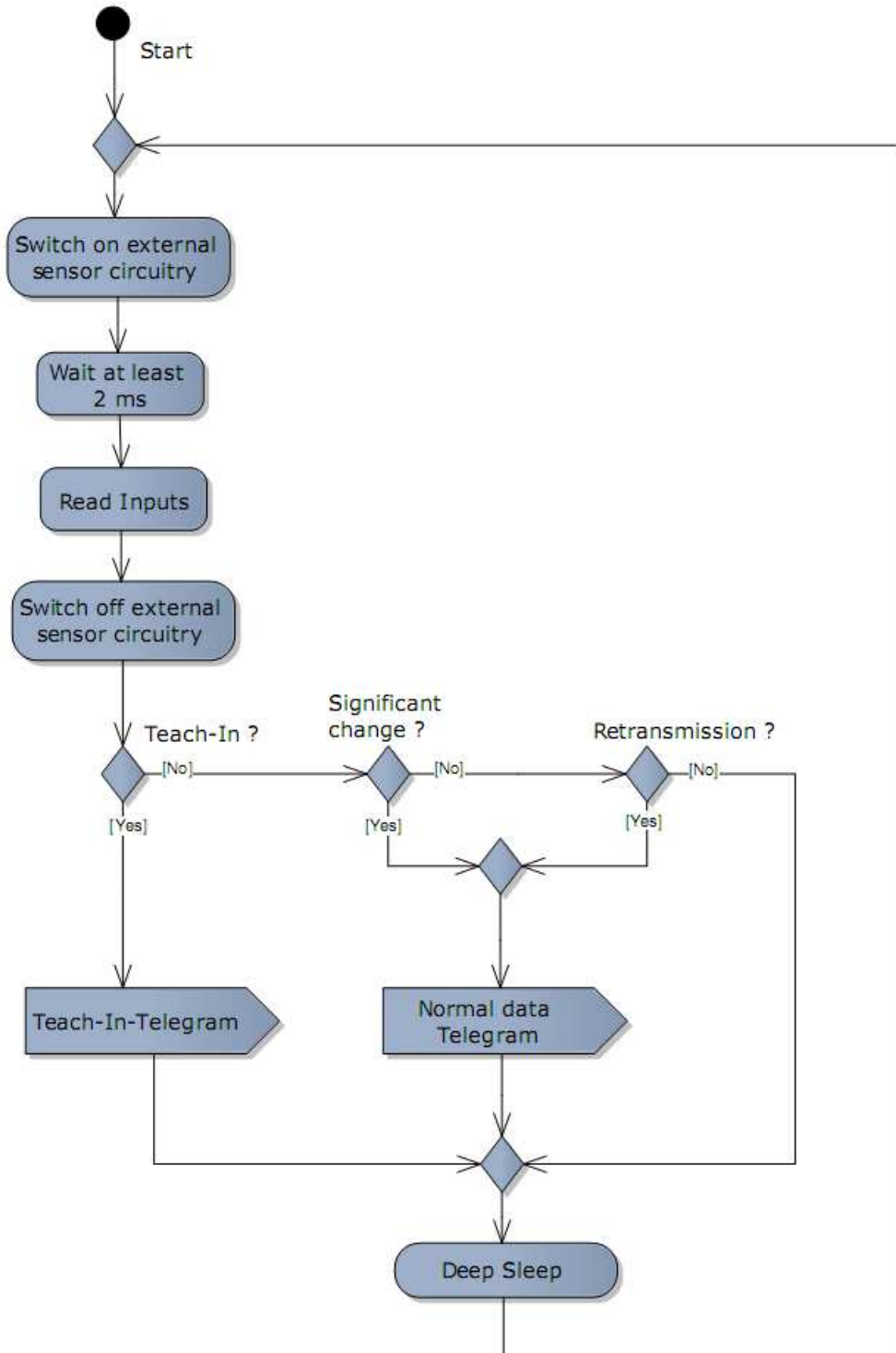

3.2 Simplified device block diagram

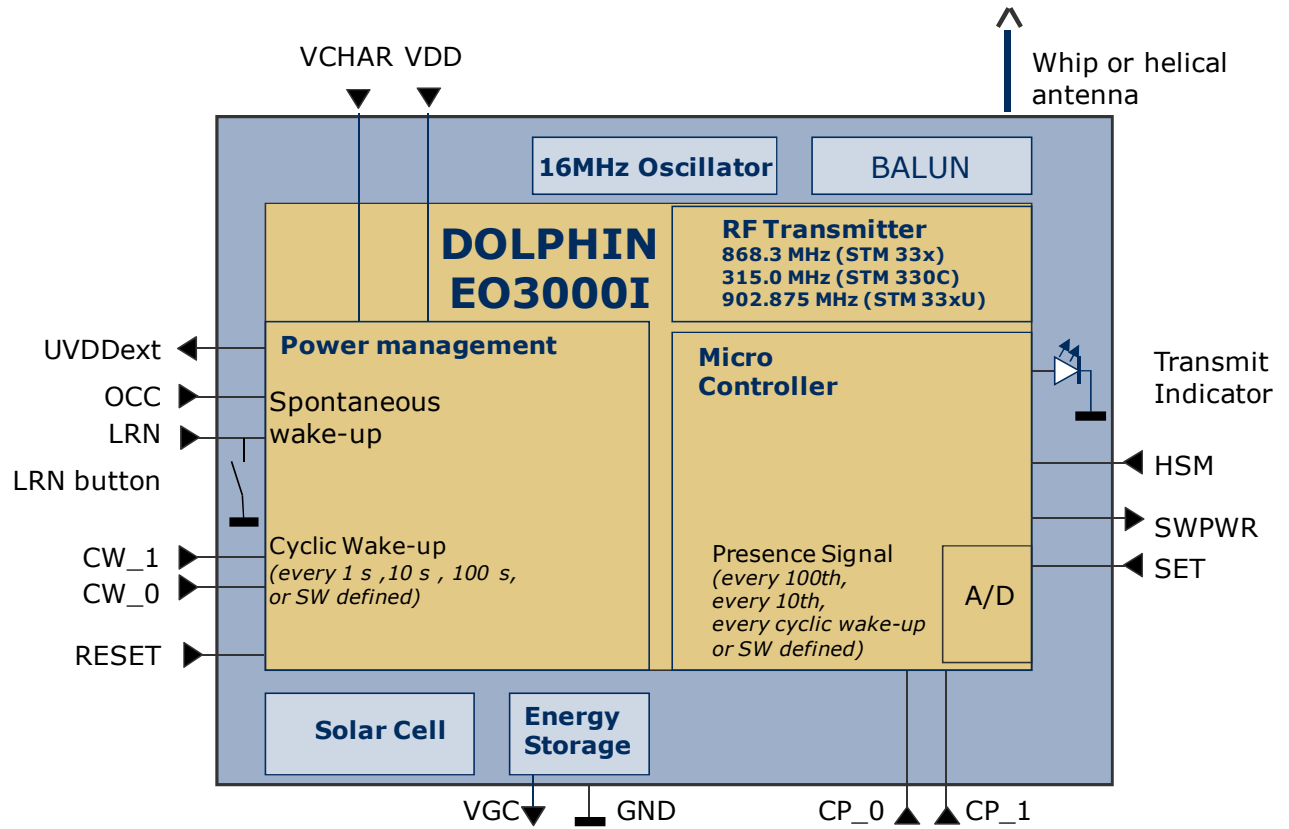

3.3 Pin out

UVDDext	1	○	○	2	WAKE0
WAKE1	3	○	○	4	VGC
GND	5	○	○	6	VCHAR
PROG_EN	7	○	○	8	SWPWR
ADIO0	9	○	○	10	ADIO3
ADIO1	11	○	○	12	ADIO4
ADIO2	13	○	○	14	ADIO6
RESET	15	○	○	16	ADIO7
RSDADIO3	17	○	○	18	SCLKDIO1
WSDADIO2	19	○	○	20	SCSEDIO0

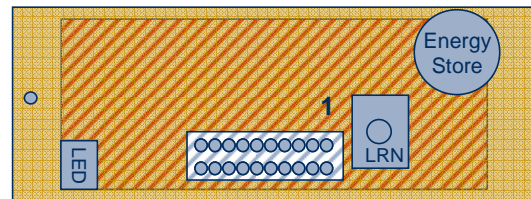

The figure above shows the pin out and location of the extension connector provided by STM 33x modules. The connector pins are named according to the naming of the EO3000I chip to simplify usage of the DOLPHIN API.

The connector type is Samtec FTSH-110-01-L-DV-P-TR or a functional equivalent. Please refer to Samtec for detailed drawings and recommendation about suitable mating connectors as needed.

The table in section 3.4 shows the translation of hardware pins to a naming that fits the functionality of the built-in firmware.

3.4 Pin description and operational characteristics

STM 33x Hardware Symbol	STM 33x Firmware Symbol	Function	Characteristics
GND	GND	Ground connection	
VDD	VDD	Supply voltage	2.1 V – 5.0 V; Start-up voltage: 2.6 V Maximum ripple: see 3.7 Not available at pin header.
		Supply for programming I/F	Recommended supply voltage for programming 3V
VCHAR	VCHAR	Charging input	Input for an external energy harvester or a battery. See 3.11.
		Supply for programming I/F if VDD cannot be used. ⁶	Recommended supply voltage for programming 3.3V – 3.6 V
VGC	VGC	Voltage Gold Cap	Connection of additional external energy storage possible. See 3.11.
SWPWR (= switched DVDD of EO3000I)	SWPWR	DVDD supply voltage regulator output switched via transistor controlled by EO3000I ADIO5 pin.	1.8 V. Output current: max. 5 mA. Supply for external circuitry, available while not in deep sleep mode. SWPWR is switched on 0.25 ms before sampling of inputs and is switched off afterwards.
UVDDext (=UVDD of EO3000I with 1.8MΩ in series)	UVDDext	Ultra low power supply voltage regulator output	Not for supply of external circuitry! For use with WAKE pins only, see section 4.1. Limited to max. 1 μA output current by internal 1.8 MΩ resistor!
IOVDD (not available at pin connector)	IOVDD	GPIO supply voltage	Internal connection to EO3000I DVDD (typ. 1.8 V) See 3.4.1
RESET	RESET	Reset input Programming I/F	Active high reset (1.8 V) Fixed internal 10 kΩ pull-down.
PROG_EN	PROG_EN	Programming I/F	HIGH: programming mode active LOW: operating mode Digital input, fixed internal 10 kΩ pull-down.
ADIO0	SET	Analog input	For connection of an external set point dial. See 4.3
ADIO1		Not used	Internal pull-up; do not connect
ADIO2		Not used	Internal pull-up; do not connect

⁶ E.g. if module shall be programmed or configured via pin connector.

If a bed of nails fixture for programming is available VDD should be used instead of VCHAR.

ADIO3	HSM	Input for HSM 100	Internal pull-up; leave open or connect HSM 100
ADIO4		Not used	Internal pull-up; do not connect
ADIO6		Not used	Internal pull-up; do not connect
ADIO7		Programming I/F	Leave open
SCSEDIO0	CW_1	Encoding input for wake-up cycle	Configuration interface. Leave open or connect to GND. See 3.8.1. Internal pull-up
		Programming I/F	
SCLKDIO1	CW_0	Encoding input for wake-up cycle	Configuration interface. Leave open or connect to GND. See 3.8.1. Internal pull-up
		Programming I/F	
WSDADIO2	CP_1	Encoding input for retransmission	Configuration interface. Leave open or connect to GND. See 3.8.1. Internal pull-up
		Programming I/F	
RSDADIO3	CP_0	Encoding input for retransmission	Configuration interface. Leave open or connect to GND. See 3.8.1. Internal pull-up
		Programming I/F	
WAKE0	OCC	Wake input	Input for external occupancy button. Change of logic state leads to wake-up and transmission of a telegram if correct EEPROM selected. See 3.8.2. Must be connected to UVDDext or GND! At time of delivery WAKE0 is connected to UVDDext via a jumper at the connector. See also 4.1.
WAKE1	LRN	LRN input	Change of logic state to LOW leads to wake-up and transmission of teach-in telegram. Internal pull-up to UVDD. See also 3.9.2 and 4.1.

3.4.1 GPIO supply voltage

The IOVDD pin of EO3000I is internally connected to DVDD. For digital communication with other circuitry therefore a voltage of 1.8 V has to be used. While the module is in deep sleep mode the microcontroller with all its peripherals is switched off and DVDD, IOVDD, and SWPWR are not supplied.



If DVDD=0 V and IOVDD is not supplied (e.g. while in sleep mode), do not apply voltage to ADIO0 to ADIO7 and the pins of the serial interface (SCSEDIO0, SCLKDIO1, WSDADIO2, RSDADIO3). This may lead to unpredictable malfunction of the device.



For I/O pins configured as analog pins the IOVDD voltage level is not relevant! See also 3.4.2.

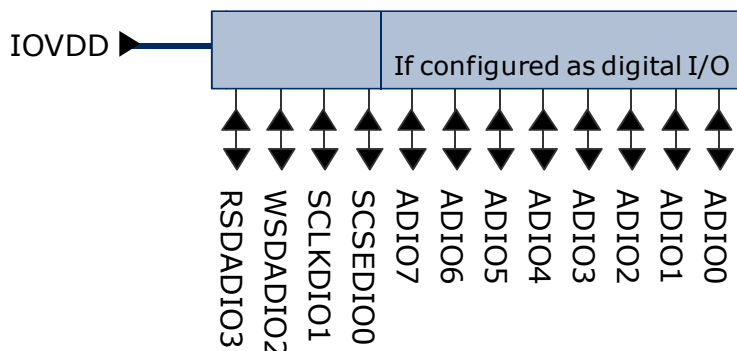

3.4.2 Analog and digital inputs

Parameter	Conditions / Notes	Min	Typ	Max	Units
Analog Input Mode					
Measurement range	Single ended Internal reference RVDD/2	0.07		RVDD-0.07	V
	Interpreted as ⁷	0x00		0xFF	
Input coupling			DC		
Input impedance	Single ended against GND @ 1 kHz	10			MΩ
Input capacitance	Single ended against GND @ 1 kHz			10	pF

Parameter	Conditions / Notes	Min	Typ	Max	Units
Digital Input Mode					
Input HIGH voltage		2/3 IOVDD			V
Input LOW voltage				1/3 IOVDD	V
Pull up resistor	@IOVDD=1.7 ... 1.9 V	90	132	200	kΩ

3.4.3 Temperature sensor

Parameter	Conditions / Notes	Min	Typ	Max	Units
Measurement range		0		40	°C
Accuracy	17 - 27 °C		0.5		K
	0 - 40		1		K

⁷ For measurement of set point with external set point dial

3.4.4 Programming Interface

The positions of the pads needed for programming are shown in the layout below. Data are available from EnOcean as Gerber files (STM3XY(C)_05.GTL and STM3XY(C)_05.GK0).

Number	Symbol
1	VDD
2	GND
3	PROG_EN
4	RESET
5	SCSEDIO0
6	SCLKDIO1
7	WSDADIO2
8	RSDADIO3
9	ADIO7
10	ADIO6 Only if in addition to programming I/F a serial interface is needed

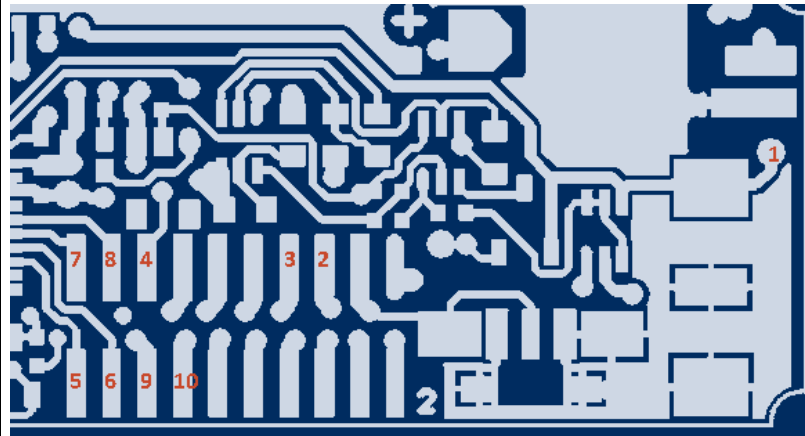

Top layer

If VDD is not accessible, e.g. because the module shall be programmed via the pin connector, please use VCHAR instead of VDD (see 0).

3.5 Absolute maximum ratings (non operating)

Symbol	Parameter	Min	Max	Units
VDD	Supply voltage at VDD	-0.5	5.5	V
VGC	Voltage gold cap	1.5	3.3	V
VCHAR	Supply voltage from external energy harvester	0	6	V
ICHAR	Supply current from external energy harvester		45	mA
GND	Ground connection	0	0	V
VINA	Voltage at every analog input pin	-0.5	2	V
VIND	Voltage at RESET, WAKE0/1, and every digital input	-0.5	3.6	V

3.6 Maximum ratings (operating)

Symbol	Parameter	Min	Max	Units
VDD	Supply voltage at VDD and VDDLIM	2.1	5.0	V
VGC	Voltage gold cap	1.5	3.3	V
VCHAR	Supply voltage from external energy harvester	0	6	V
ICHAR	Supply current from external energy harvester VCHAR < 4 V 4 V < VCHAR < 6 V		Limited internally 45	mA
GND	Ground connection	0	0	V
VINA	Voltage at every analog input pin	0	2.0	V
VIND	Voltage at RESET, WAKE0/1, and every digital input	0	3.6	V

3.7 Power management and voltage regulators

Symbol	Parameter	Conditions / Notes	Min	Typ	Max	Units
Voltage Regulators						
VDDR	Ripple on VDD, where Min(VDD) > VON				50	mV _{pp}
UVDD	Ultra Low Power supply			1.8		V
RVDD	RF supply	Internal signal only	1.7	1.8	1.9	V
DVDD	Digital supply	Internal signal only	1.7	1.8	1.9	V
Threshold Detector						
VON	Turn on threshold		2.3	2.45	2.6	V
VOFF	Turn off threshold	Automatic shutdown if VDD drops below VOFF	1.85	1.9	2.1	V

Threshold detector

STM 33x provides an internal ultra low power ON/OFF threshold detector.

If $VDD > VON$, it turns on the ultra low power regulator (UVDD), the watchdog timer and the WAKE# pins circuitry. If $VDD \leq VOFF$, it initiates the automatic shut down of STM 33x.

For details of this mechanism please refer to the Dolphin Core Description documentation.

3.8 Configuration

3.8.1 Configuration via pins

The encoding input pins have to be left open or connected to GND in correspondence with the following connection schemes. These settings are checked at every wake-up.

Wake-up cycle time

CW_0	CW_1	Wake-up cycle time
NC	GND	1 s \pm 20%
GND	NC	10 s \pm 20%
NC	NC	100 s \pm 20%
GND	GND	No cyclic wake-up

Redundant retransmission

Via CP_0 and CP_1 an internal counter is set which is decreased at every wake-up signal. Once the counter reaches zero the redundant retransmission signal is sent.

CP_0	CP_1	Number of wake-ups that trigger a redundant retransmission
GND	NC	Every timer wake-up signal
NC	NC	Every 7 th - 14 th timer wake-up signal, affected at random
NC	GND	Every 70 th - 140 th timer wake-up signal, affected at random
GND	GND	No redundant retransmission



A radio telegram is always transmitted after wake-up via WAKE pins! After transmission the counter is reset to a random value within the specified interval.



According to FCC 15.231a) a redundant retransmission at every timer wake-up to determine the system integrity is only allowed in safety and security applications! In this case the total transmission time must not exceed two seconds per hour, which means that a combination with a 1 s wake-up cycle time is not allowed!

If applied in other (non-safety, non-security) applications a minimum of 10 s between periodic transmissions is required. In addition the device has to comply with the lower field strength limits of 15.231e). The limited modular approval of STM 330C / 332U / 333U is not valid in this case.

3.8.2 Configuration via serial interface

Via the programming interface the configuration area can be modified. This provides a lot more configuration options. Values set via serial interface override hardware settings! These settings are read after RESET or power-on reset only and not at every wake-up of the module!

Parameter	Configuration via pins	Configuration via serial interface
Wake up cycle	See section 3.8.1	Value can be set from 1 s to 65534 s
Redundant Retransmission cycle	See section 3.8.1	Min...Max values for random interval If Min=Max -> random switched off
Threshold values for inputs <small>(transmission of telegram if threshold value exceeded)</small>	No	The default values are: Temperature measurement: ±0.5 K Set point measurement: ±10 digits
Edge of wake pin change causing a telegram transmission	No	Every change of a wake pin triggers a wake-up. For both wake pins it can be configured individually if a telegram shall be sent on rising, falling or both edges.
Manufacturer ID and EEPROM (EnOcean Equipment Profile)	No	Information about manufacturer and type of device. This feature is needed for "automatic" interoperability of sensors and actuators or bus systems. Unique manufacturer IDs are distributed by the EnOcean Alliance.

The interface is shown in the figure below:

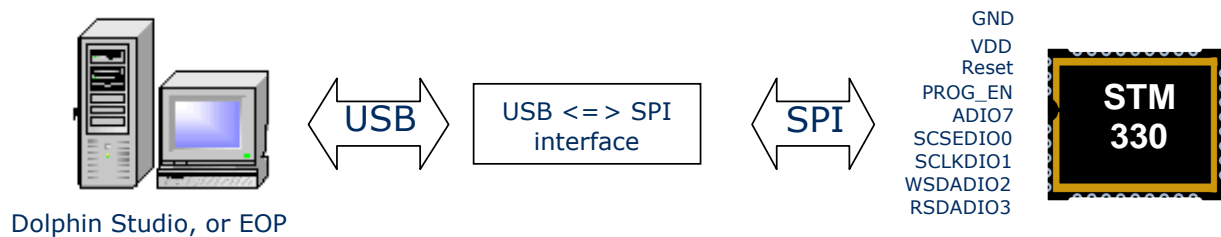

EnOcean provides EOPx (EnOcean Programmer, a command line program) and Dolphin Studio (Windows application for chip configuration, programming, and testing) and the USB/SPI programmer device as part of the EDK 300 or EDK 350 developer's kit.

The configuration page of DolphinStudio is shown in the figure below.

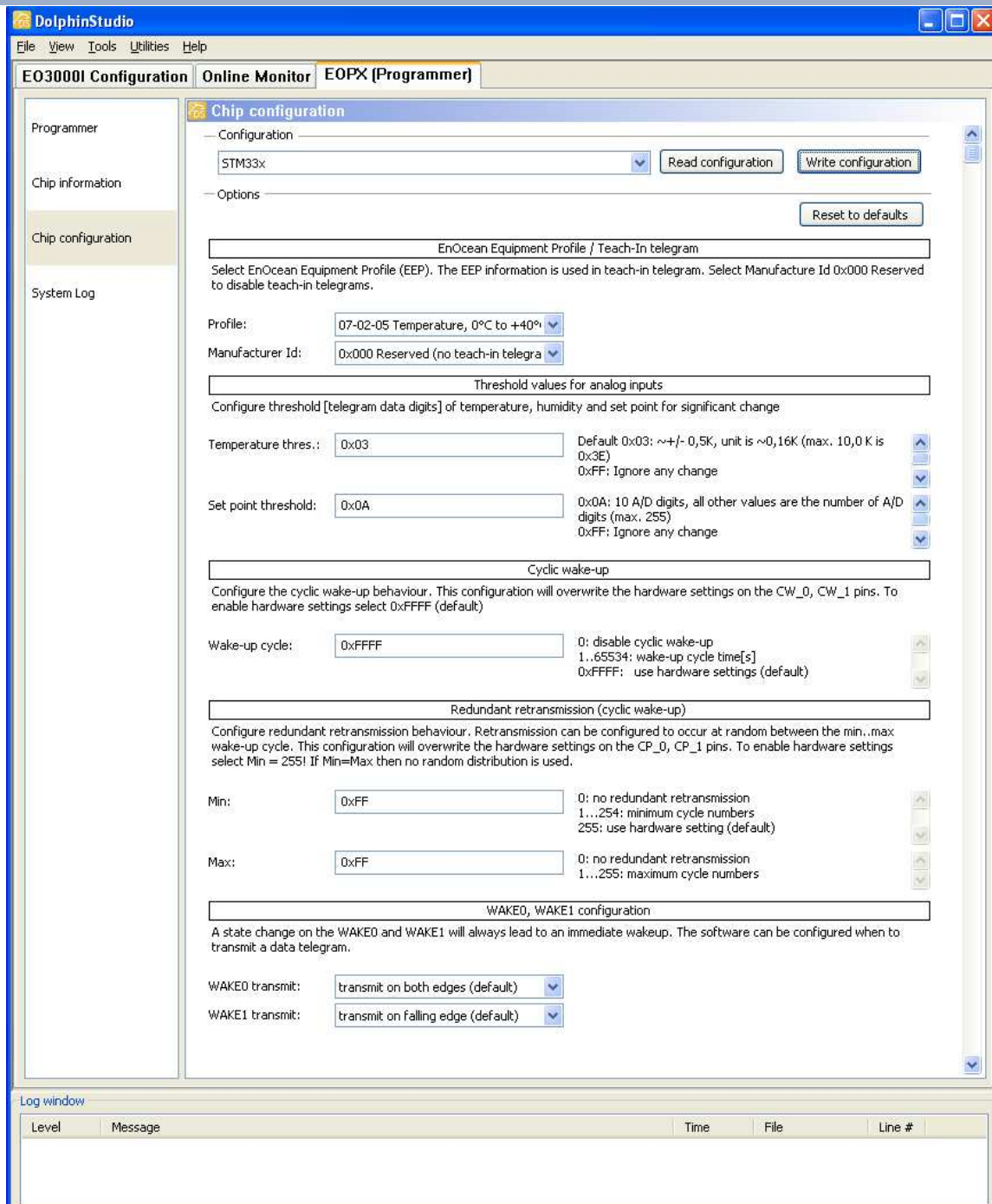

Please select STM 33x and press "Read configuration" button before modifying the entries!

3.9 Radio telegram

3.9.1 Normal operation

In normal operation STM 33x transmits telegram data according to the selected EEP (EnOcean Equipment Profile).

For details please refer to the EnOcean Equipment Profiles 2.5 specification.

3.9.2 Teach-in telegram

In case of a wake-up via WAKE1 pin (LRN input) the module transmits a teach-in telegram.

- If the manufacturer code is not set, the module transmits a normal telegram according to 3.9.1 with the difference that DI_3=0.
- If a manufacturer code is set, this teach-in telegram contains special information as described below.

With this special teach-in telegram it is possible to identify the manufacturer of a device and the function and type of a device. The following EnOcean Equipment Profiles are supported by STM 33x. They have to be selected according to the availability of external occupancy button and set point control by the method described in 3.8.2:

- A5-02-05 Temperature sensor 0-40 °C (default)
- A5-10-03 Temperature sensor 0-40 °C, set point control
- A5-10-05 Temperature sensor 0-40 °C, set point, and occupancy control

If a HSM 100 module is plugged onto the connector in addition the following EEPs are supported:

- A5-04-01 Temperature and humidity sensor 0-40 °C and 0-100% r.h.
- A5-10-10 Temperature and humidity sensor 0-40 °C and 0-100% r.h., set point control, and occupancy control
- A5-10-12 Temperature and humidity sensor 0-40 °C and 0-100% r.h., set point control

For details please refer to the EnOcean Equipment Profiles 2.5 specification.

3.10 Transmit timing

The setup of the transmission timing allows avoiding possible collisions with data packages of other EnOcean transmitters as well as disturbances from the environment. With each transmission cycle, 3 identical sub-telegrams are transmitted within 40ms. Transmission of a sub-telegram lasts approximately 1.2ms. The delay between the three transmission bursts is affected at random.

3.11 Charging circuitry

The figure below shows the internal charging circuit. It is controlled via the WXODIO pin of EO3000I which switches according to the status of the internal threshold detector. For details please refer to our Dolphin Core Description documentation. The WXIDIO pin is used to disconnect the goldcap at voltages below VOFF to avoid deep discharge.

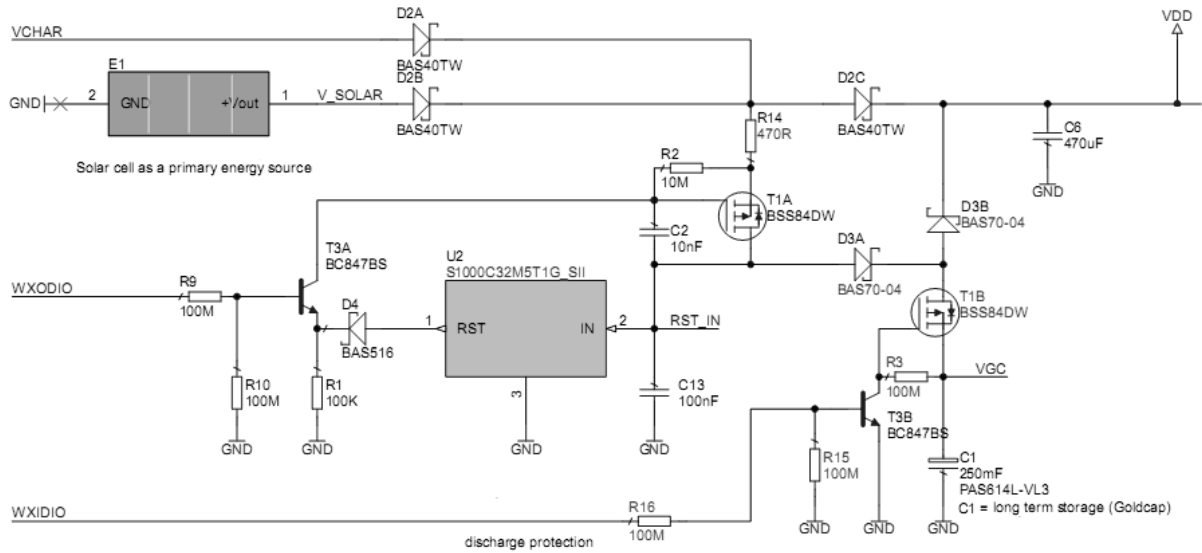

An external 3 V backup battery can be connected at VCHAR.

3.12 Energy consumption

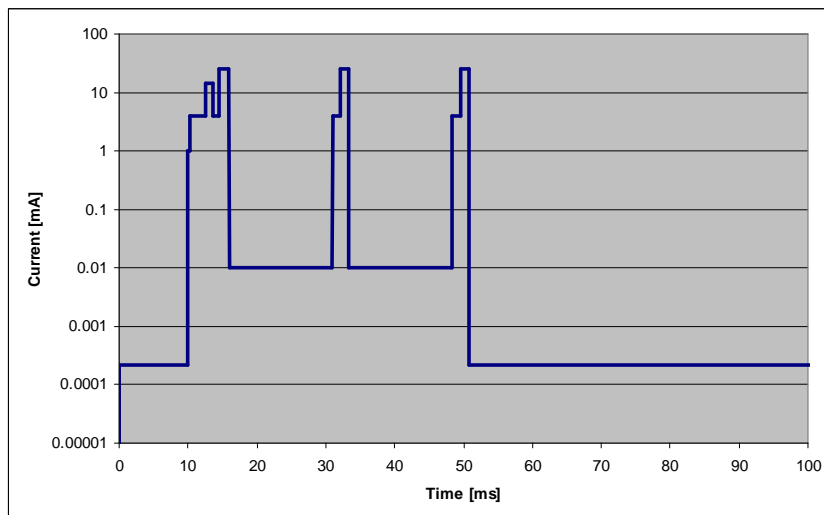

Current Consumption of STM 33x

Charge needed for one measurement and transmit cycle: ~130 μC
 Charge needed for one measurement cycle without transmit: ~30 μC
 (current for external sensor circuits not included)

Calculations are performed on the basis of electric charges because of the internal linear voltage regulator of the module. Energy consumption varies with voltage of the energy storage while consumption of electric charge is constant.

From these values the following typical performance parameters at room temperature have been calculated:

Wake cycle [s]	Transmit interval	Operation Time in darkness [h] when storage fully charged	Required reload time [h] at 200 lux within 24 h for continuous operation	24 h operation after 6 h illumination at x lux	Illumination level in lux for continuous operation	Current in μA required for continuous operation
1	1	0.5	storage too small	storage too small	5220	130.5
1	10	1.7	storage too small	storage too small	1620	40.5
1	100	2.1	storage too small	storage too small	1250	31.3
10	1	5.1	storage too small	storage too small	540	13.5
10	10	16	21	storage too small	175	4.4
10	100	20	16.8	storage too small	140	3.5
100	1	43	7.8	260	65	1.6
100	10	98	3.6	120	30	0.8
100	100	112	3	100	25	0.6

Assumptions:

- Internal storage PAS614L-VL3 (after several days of operation at good illumination level) with 0.25 F, $U_{\text{max}}=3.2\text{ V}$, $U_{\text{min}}=2.2\text{ V}$, $T=25\text{ }^\circ\text{C}$
- Consumption: Transmit cycle 100 μC , measurement cycle 30 μC
- Pre-installed solar cell ECS 300, operating values 3 V and 5 μA @ 200 lux fluorescent light
- Current proportional to illumination level (not true at very low levels!)

These values are calculated, the accuracy is about +/-20%! The performance varies over temperature and may be strongly reduced at extreme temperatures or short transmit intervals.

4 APPLICATIONS INFORMATION

4.1 Using the WAKE pins

The logic input circuits of the WAKE0 and WAKE1 pins are supplied by UVDD and therefore also usable in "Deep Sleep Mode". Due to current minimization there is no internal pull-up or pull-down at the WAKE pins. When STM 33x is in "Deep Sleep Mode" and the logic levels of WAKE0 and / or WAKE1 is changed, STM 33x starts up.



As there is no internal pull-up or pull-down at the WAKE0 pin, it has to be ensured by external circuitry, that the WAKE0 pin is at a defined logic level at any time. At time of delivery a jumper is connected between WAKE0 and UVDDext. WAKE1 provides an internal 1.8 M Ω pull-up. See figure below.

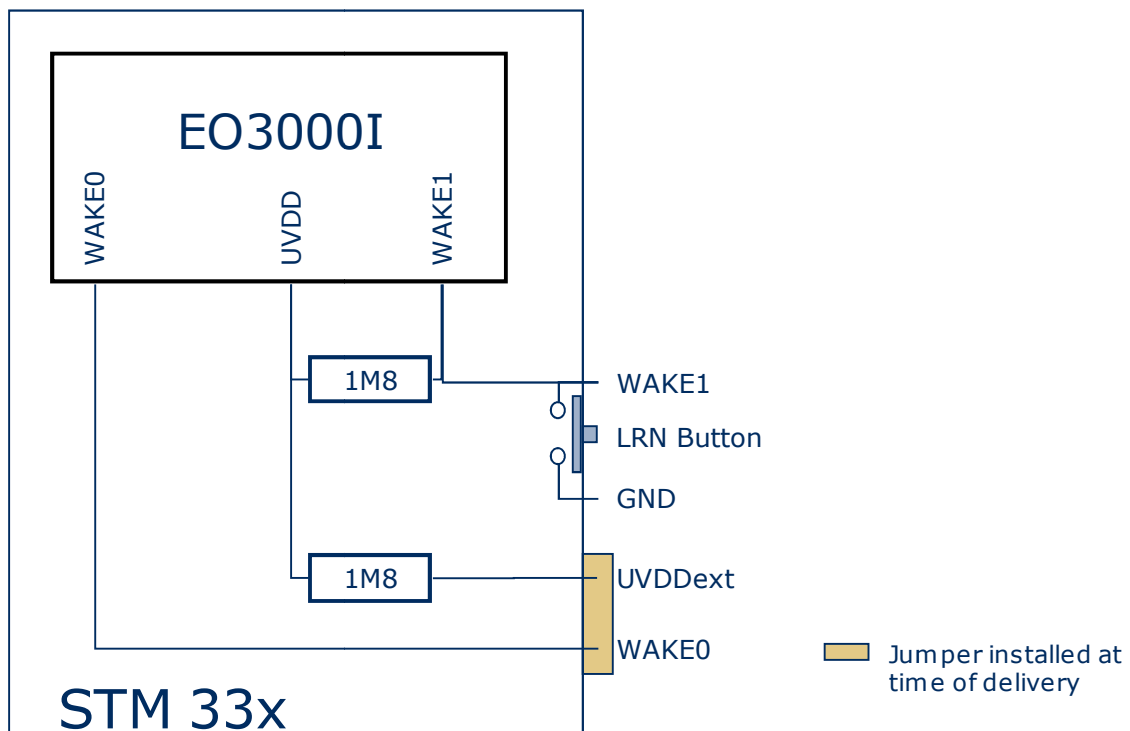

When the LRN button is pressed WAKE1 is pulled to GND and a teach-in telegram is transmitted. As long as the button is pressed a small current of approximately 1 μ A is flowing. It is possible to connect an additional external button in parallel between WAKE1 and GND if a different position of the button in the device is required.

WAKE0 is connected to UVDDext via a jumper at time of delivery. If the module is mounted onto a host PCB the jumper has to be removed. The circuitry on the host PCB then has to ensure that WAKE0 is always in a defined position.

There are two ways to use WAKE0:

- Connect WAKE0 to UVDDext and connect an external button between WAKE0 and GND. As long as the button is pressed a current of 1 μ A will flow.
- Connect a 3 terminal switch and switch WAKE0 to either GND or UVDDext. In this case there is no continuous flow of current in either position of the switch.

4.2 Temperature sensor

STM 33x provides an internal temperature sensor. The sensor is part of the EO3000I IC and measures the chip temperature. Therefore it is important to provide a good thermal connection of the IC to the environment by ensuring sufficient ventilation of air inside the housing. Only then the measurement will represent the ambient temperature. Depending on the design of the housing a delay between ambient temperature changes and measured temperature value will be seen.



Heating of the chip due to its current consumption is negligible as the chip only consumes 200 nA while in sleep mode.

Temperature measurement every second is not recommended as in this case effects of heating of the chip might become visible and accuracy is reduced.

4.3 Set point control and occupancy button

In order to control the set point, an external potentiometer has to be connected as shown below. In addition this figure shows how to connect the occupancy button.

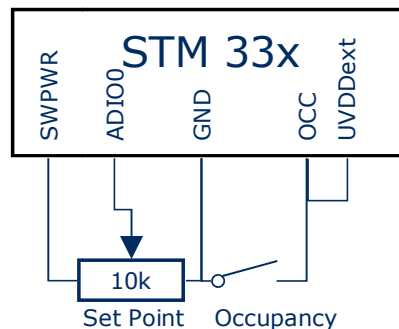

4.4 Combination with humidity sensor module HSM 100

The humidity sensor module HSM 100 extends the functionality of STM 33x temperature sensor modules. HSM 100 contains an internal calibrated humidity sensor. It can be plugged onto STM 33x modules via the 20 pin connector. For details please refer to the data sheet of HSM 100.

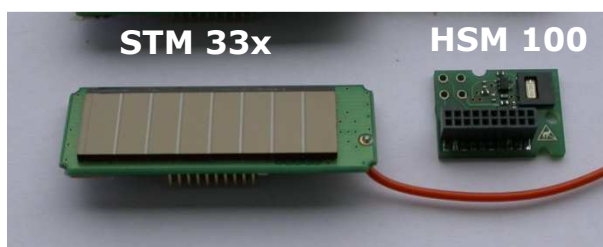

4.5 Antenna layout

4.5.1 Whip antenna (STM 330 / STM 330C / STM 332U)

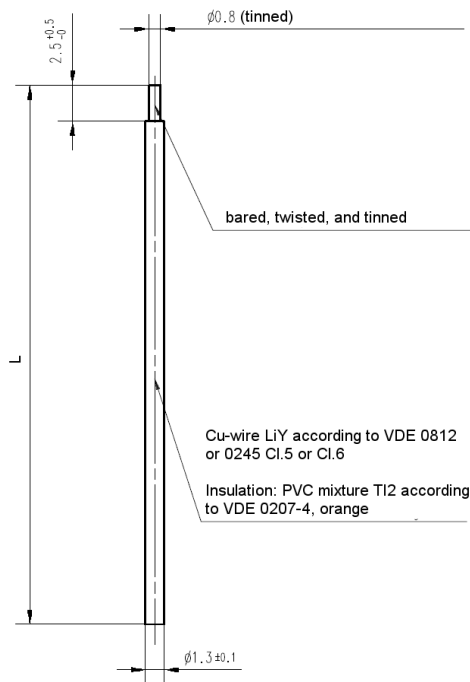

Specification of the whip antenna; L=150 mm @ 315 MHz, L=86 mm @ 868 MHz, L=64mm @ 902.875MHz

Antenna layout recommendation:

STM 330 without host PCB

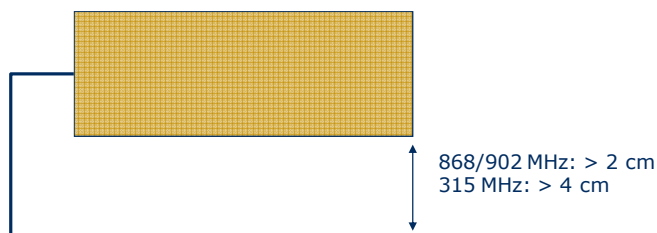

STM 330 with host PCB

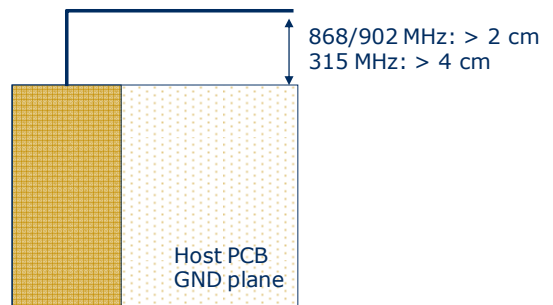

4.5.2 Helical antenna (STM 331 / STM 333U)

868 MHz/902 MHz

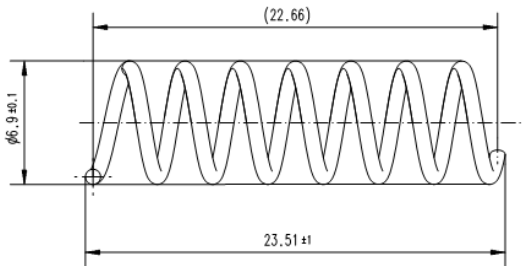

Antenna recommendation:

STM 33x without host PCB

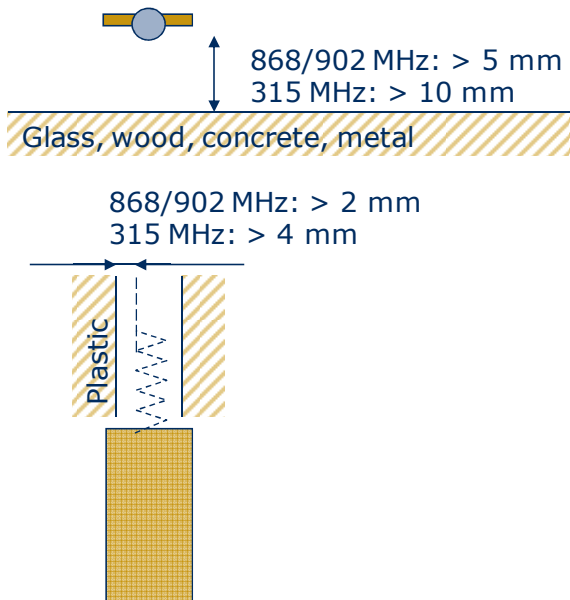

STM 33x with host PCB

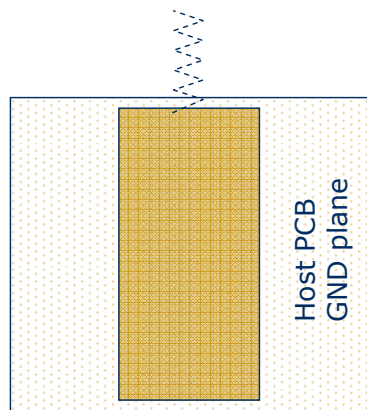

4.6 Mounting STM 33x into a housing

The figure below shows an example of a housing in which the module can be mounted (with antenna pointing to the left). Design data of the housing and the modules is available in .igs format.

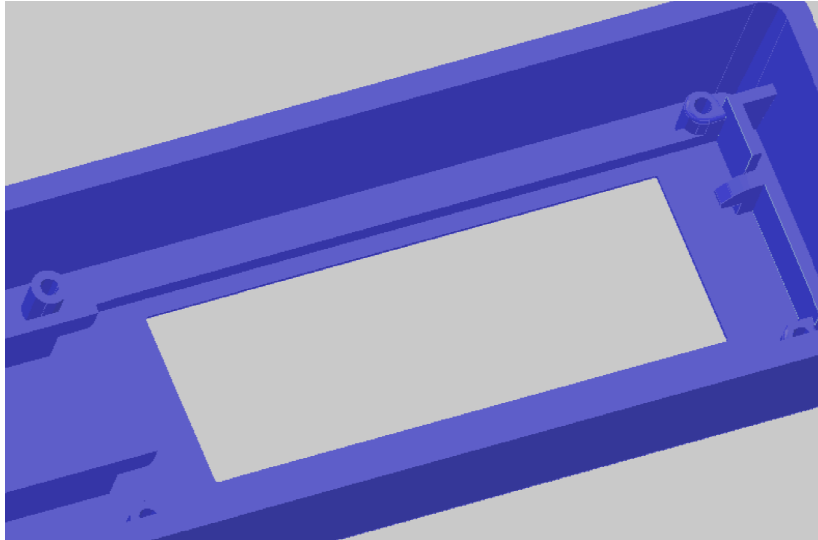

In order to prevent damage to the solar cell and the module itself, please make sure not to exert shear force (side force within the plane of the solar cell) onto the solar cell! The maximum vertical force onto the solar cell must not exceed 4 N and should be homogeneously distributed! Bending of the PCB must be avoided!



Please make sure that the housing covers 0.5 mm at the solar cell edges. Within 0.5 mm off the edge flaking is possible due to the cutting process.

4.7 Transmission range

The main factors that influence the system transmission range are type and location of the antennas of the receiver and the transmitter, type of terrain and degree of obstruction of the link path, sources of interference affecting the receiver, and "Dead" spots caused by signal reflections from nearby conductive objects. Since the expected transmission range strongly depends on this system conditions, range tests should categorically be performed before notification of a particular range that will be attainable by a certain application.

The following figures for expected transmission range may be used as a rough guide only:

- Line-of-sight connections: Typically 30 m range in corridors, up to 100 m in halls
- Plasterboard walls / dry wood: Typically 30 m range, through max. 5 walls
- Ferroconcrete walls / ceilings: Typically 10 m range, through max. 1 ceiling
- Fire-safety walls, elevator shafts, staircases and supply areas should be considered as screening.

The angle at which the transmitted signal hits the wall is very important. The effective wall thickness – and with it the signal attenuation – varies according to this angle. Signals should be transmitted as directly as possible through the wall. Wall niches should be avoided. Other factors restricting transmission range:

- Switch mounted on metal surfaces (up to 30% loss of transmission range)
- Hollow lightweight walls filled with insulating wool on metal foil
- False ceilings with panels of metal or carbon fiber
- Lead glass or glass with metal coating, steel furniture

The distance between EnOcean receivers and other transmitting devices such as computers, audio and video equipment that also emit high-frequency signals should be at least 0.5 m.

A summarized application note to determine the transmission range within buildings is available as download from www.enocean.com.

5 AGENCY CERTIFICATIONS

The modules have been tested to fulfil the approval requirements for CE (STM 330 / STM 331) and FCC/IC (STM 330C / STM 332U / STM 333U) based on the built-in firmware.



When developing customer specific firmware based on the API for this module, special care must be taken not to exceed the specified regulatory limits, e.g. the duty cycle limitations!

5.1 CE Approval

The STM 330 / STM 331 module bears the EC conformity marking CE and conforms to the R&TTE EU-directive on radio equipment. The assembly conforms to the European and national requirements of electromagnetic compatibility. The conformity has been proven and the according documentation has been deposited at EnOcean. The modules can be operated without notification and free of charge in the area of the European Union and in Switzerland.



- EnOcean RF modules must not be modified or used outside their specification limits.
- EnOcean RF modules may only be used to transfer digital or digitized data. Analog speech and/or music are not permitted.
- EnOcean RF modules must not be used with gain antennas, since this may result in allowed ERP or spurious emission levels being exceeded.
- The final product incorporating EnOcean RF modules must itself meet the essential requirement of the R&TTE Directive and a CE marking must be affixed on the final product and on the sales packaging each. Operating instructions containing a Declaration of Conformity has to be attached.
- If the STM 33x transmitter is used according to the regulations of the 868.3 MHz band, a so-called "Duty Cycle" of 1% per hour must not be exceeded. Permanent transmitters such as radio earphones are not allowed.
- The module must be used with only the following approved antenna(s).

Model	Type
STM 330	Pre-installed whip antenna
STM 331	Pre-installed helix antenna

5.2 FCC (United States) certification

5.2.1 STM 330C / 332U / 333U LIMITED MODULAR APPROVAL

This is an RF module approved for Limited Modular use operating as an intentional transmitting device with respect to 47 CFR 15.231(a-c) and is limited to OEM installation. The module is optimized to operate using small amounts of harvested energy, such as can be collected by a small solar cell exposed to ambient light.

The module transmits short radio packets comprised of control signals, (in some cases the control signal may be accompanied with data) such as those used with alarm systems, door openers, remote switches, and the like.

The module does not support continuous streaming of voice, video, or any other forms of streaming data; it sends only short packets containing control signals and possibly data and is typically powered by a solar cell in ambient light. The module is designed to comply with, has been tested according to 15.231(a-c), and has been found to comply with each requirement.

Thus, a finished device containing the STM 330C / 332U / 333U radio module can be operated in the United States without additional Part 15 FCC approval (approval(s) for unintentional radiators may be required for the OEM's finished product), under EnOcean's FCC ID number. This greatly simplifies and shortens the design cycle and development costs for OEM integrators.

The module can be triggered manually or automatically, which cases are described below.

Manual Activation

The radio module can be configured to transmit a short packetized control signal if triggered manually. The module can be triggered, by pressing a switch, for example. The packet contains one (or more) control signals that is(are) intended to control something at the receiving end. The packet may also contain data. Depending on how much energy is available from the energy source, subsequent manual triggers can initiate the transmission of additional control signals. This may be necessary if prior packet(s) was (were) lost to fading or interference. Subsequent triggers can also be initiated as a precaution if any doubt exists that the first packet didn't arrive at the receiver. Each packet that is transmitted, regardless of whether it was the first one or a subsequent one, will only be transmitted if enough energy is available from the energy source.

Automatic Activation

The radio module also can be configured to transmit a short packetized control signal if triggered automatically, by a relevant change of its inputs, for example. Again, the packet contains a control signal that is intended to control something at the receiving end and may also contain data. As above, it is possible for the packet to get lost and never reach the receiver. However, if enough energy is available from the energy source, and the module has been configured to do so, then another packet or packets containing the control signal may be transmitted at a later, unpredictable time.

OEM Requirements

In order to use EnOcean's FCC ID number, the OEM must ensure that the following conditions are met.

- End users of products, which contain the module, must not have the ability to alter the firmware that governs the operation of the module. The agency grant is valid only when the module is incorporated into a final product by OEM integrators.
- The end-user must not be provided with instructions to remove, adjust or install the module.
- The Original Equipment Manufacturer (OEM) must ensure that FCC labeling requirements are met. This includes a clearly visible label on the outside of the final product. Attaching a label to a removable portion of the final product, such as a battery cover, is not permitted. The label must include the following text:

STM 330C:

Contains FCC ID: SZV-STM310C

The enclosed device complies with Part 15 of the FCC Rules. Operation is subject to the following two conditions: (i.) this device may not cause harmful interference and (ii.) this device must accept any interference received, including interference that may cause undesired operation.

STM 332U:

Contains FCC ID: SZV-STM332U

The enclosed device complies with Part 15 of the FCC Rules. Operation is subject to the following two conditions: (i.) this device may not cause harmful interference and (ii.) this device must accept any interference received, including interference that may cause undesired operation.

STM 333U:

Contains FCC ID: SZV-STM332U

The enclosed device complies with Part 15 of the FCC Rules. Operation is subject to the following two conditions: (i.) this device may not cause harmful interference and (ii.) this device must accept any interference received, including interference that may cause undesired operation.

When the device is so small or for such use that it is not practicable to place the statement above on it, the information required by this paragraph shall be placed in a prominent location in the instruction manual or pamphlet supplied to the user or, alternatively, shall be placed on the container in which the device is marketed. However, the FCC identifier or the unique identifier, as appropriate, must be displayed on the device.

The user manual for the end product must also contain the text given above.

- Changes or modifications not expressly approved by EnOcean could void the user's authority to operate the equipment.
- The OEM must ensure that timing requirements according to 47 CFR 15.231(a-c) are met.
- The OEM must sign the OEM Limited Modular Approval Agreement with EnOcean

- The module must be used with only the following approved antenna(s).

Model	Type	Gain
STM 330C	Pre-installed Wire/Monopole	1.0 dBi
STM 332U	Pre-installed Wire/Monopole	1.0 dBi
STM 333U	Pre-installed Helical Antenna	-1.0 dBi

5.2.2 STM 330C FCC Grant

TCB

**GRANT OF EQUIPMENT
AUTHORIZATION**

Certification
Issued Under the Authority of the
Federal Communications Commission

By:

PHOENIX TESTLAB GmbH
Koenigswinkel 10
D-32825 Blomberg,
Germany

Date of Grant: 09/27/2010
Application Dated: 09/27/2010

TCB

EnOcean GmbH
Kolpingring 18a
Oberhaching, 82041
Germany

Attention: Armin Anders , Director Product Marketing

NOT TRANSFERABLE

EQUIPMENT AUTHORIZATION is hereby issued to the named GRANTEE, and is VALID ONLY for the equipment identified hereon for use under the Commission's Rules and Regulations listed below.

FCC IDENTIFIER: SZV-STM310C
Name of Grantee: EnOcean GmbH
Equipment Class: Part 15 Security/Remote Control Transmitter
Notes: Transmitter Module
Modular Type: Limited Single Modular

Grant Notes	FCC Rule Parts	Frequency Range (MHz)	Output Watts	Frequency Tolerance	Emission Designator
	15.231	315.0 - 315.0			

5.2.3 STM 332U / STM 333U FCC Grant

TCB

**GRANT OF EQUIPMENT
AUTHORIZATION**

TCB

**Certification
Issued Under the Authority of the
Federal Communications Commission
By:**

EMCCert Dr. Rasek GmbH
Stoernhofer Berg 15
D-91364 Unterleinleiter,
Germany

Date of Grant: 06/21/2013
Application Dated: 06/21/2013

EnOcean GmbH
Kolpingring 18a
Oberhaching, 82041
Germany

Attention: Armin Anders , Director Product Marketing

NOT TRANSFERABLE

EQUIPMENT AUTHORIZATION is hereby issued to the named GRANTEE, and is VALID ONLY for the equipment identified hereon for use under the Commission's Rules and Regulations listed below.

FCC IDENTIFIER: SZV-STM332U
Name of Grantee: EnOcean GmbH
Equipment Class: Part 15 Security/Remote Control Transmitter
Notes: 902.875MHz transmitter
Modular Type: Limited Single Modular

<u>Grant Notes</u>	<u>FCC Rule Parts</u>	<u>Frequency Range (MHZ)</u>	<u>Output Watts</u>	<u>Frequency Tolerance</u>	<u>Emission Designator</u>
	15.231	902.875 - 902.875			

Limited modular approval due to lack of module shielding. Approval is limited to OEM installation only in host platforms as described in this filing.



5.2.4 FCC Regulatory Statements

This device complies with part 15 of the FCC rules. Operation is subject to the following two conditions: (1) This device may not cause harmful interference, and (2) this device must accept any interference received, including interference that may cause undesired operation. Any changes or modifications not expressly approved by manufacturer could void the user's authority to operate the equipment.

IMPORTANT! Any changes or modifications not expressly approved by the party responsible for compliance could void the user's authority to operate this equipment.

NOTE: This equipment has been tested and found to comply with the limits for a Class B digital device, pursuant to part 15 of the FCC Rules. These limits are designed to provide reasonable protection against harmful interference in a residential installation.

This equipment generates, uses and can radiate radio frequency energy and, if not installed and used in accordance with the instructions, may cause harmful interference to radio communications. However, there is no guarantee that interference will not occur in a particular installation.

If this equipment does cause harmful interference to radio or television reception, which can be determined by turning the equipment off and on, the user is encouraged to try to correct the interference by one or more of the following measures:

- Reorient or relocate the receiving antenna
- Increase the separation between the equipment and receiver
- Connect the equipment into an outlet on a circuit different from that to which the receiver is connected
- Consult the dealer or an experienced radio/ TV technician for help

5.3 IC (Industry Canada) certification

In order to use EnOcean's IC number, the OEM must ensure that the following conditions are met:

- Labeling requirements for Industry Canada are similar to those required by the FCC. The Original Equipment Manufacturer (OEM) must ensure that IC labeling requirements are met. A clearly visible label on the outside of a non-removable part of the final product must include the following text:

STM 330C:

Contains IC: 5713A-STM310C

STM 332U:

Contains IC: 5713A-STM332U

STM 333U:

Contains IC: 5713A-STM332U

- The OEM must sign the OEM Limited Modular Approval Agreement with EnOcean

Pour utiliser le numéro IC EnOcean, le OEM doit s'assurer que les conditions suivantes sont remplies:

- Les exigences d'étiquetage pour Industrie Canada sont similaires à ceux exigés par la FCC. Le fabricant d'équipement d'origine (OEM) doit s'assurer que les exigences en matière d'étiquetage IC sont réunies. Une étiquette clairement visible à l'extérieur d'une partie non amovible du produit final doit contenir le texte suivant:

STM 330C:

Contains IC: 5713A-STM310C

Contient le module d'émission IC: 5713A-STM310C

STM 332U:

Contains IC: 5713A-STM332U

Contient le module d'émission IC: 5713A-STM332U



STM 333U:

Contains IC: 5713A-STM332U

Contient le module d'émission IC: 5713A-STM332U

- L'OEM doit signer l'accord OEM limitée Approbation modulaire avec EnOcean

5.3.1 STM 330C IC Technical Approval Certificate

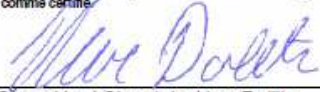
	
<p>TECHNICAL APPROVAL CERTIFICATE</p> <p>based on the Agreement on Mutual Recognition between the European Community and Canada</p>	<p>CERTIFICAT D'APPROBATION TECHNIQUE</p> <p>en se basant l'accord de reconnaissance mutuelle entre la Communauté Européenne et le Canada</p>
CERTIFICATE NUMBER <i>NUMÉRO DE CERTIFICAT</i>	10-112816a
CERTIFICATION NUMBER <i>NUMÉRO DE CERTIFICATION</i>	IC: 5713A-STM310C
TYPE OF SERVICE <i>TYPE DE SERVICE</i>	New Family Certification / Limited Modular Approval
CERTIFICATE HOLDER <i>TITULAIRE DU CERTIFICAT</i>	EnOcean GmbH Kolpingring 18a 82041 Oberhaching Germany
TYPE OF EQUIPMENT <i>GENRE DE MATÉRIEL</i>	Transmitter Module
TRADE NAME AND MODEL NUMBER <i>MARQUE ET NUMÉRO DE MODÈLE</i>	EnOcean STM312C / STM310C / STM330C
FREQUENCY RANGE <i>BANDE DE FRÉQUENCES</i>	315MHz
EMISSION DESIGNATION (TRC-43) <i>DÉSIGNATION D'ÉMISSION (CRT-43)</i>	398KA1D
R.F. POWER RATING (WATT) <i>PUISSANCE NOMINALE H.F. (WATT)</i>	/
ANTENNA INFORMATION <i>INFORMATION D'ANTENNE</i>	Whip Antenna (15cm)
CONTACT INFORMATION OF TESTING LABORATORY <i>COORDONNÉES DU LABORATOIRE D'ESSAI</i>	Center of Quality Engineering SGS Germany GmbH Hofmannstraße 50 81379 München
CERTIFIED TO <i>CERTIFIÉ SELON LE</i>	SPECIFICATION / ISSUE <i>CAHIER DES CHARGES / ÉDITION</i>
	RSS-210 Issue 7, RSS-GEN Issue 2 RSS-102 Issue 4
<p><small>Certification of equipment means only that the equipment has met the requirements of the above noted specification. License applications, where applicable to use certified equipment, are acted on accordingly by the issuing office and will depend on the existing radio environment, service and location of operation. This certificate is issued on condition that the holder complies and will continue to comply with the requirements of the radio standards specifications and procedures issued by the Department.</small></p> <p><small>La certification du matériel signifie seulement que le matériel a satisfait aux exigences de la norme indiquée ci-dessus. Les demandes de licences nécessaires pour l'utilisation du matériel certifié sont traitées en conséquence par le bureau de délivrance et dépendent des conditions radio ambiantes, du service et de l'emplacement d'exploitation. Le présent certificat est délivré à la condition que le titulaire satisfasse et continue de satisfaire aux exigences aux procédures d'Industry Canada.</small></p> <p><small>Labelling of Certified Radio Equipment: Equipment that has received certification but is not labelled with the applicant's name, model number and the certification number as outlined above is not considered certified.</small></p> <p><small>Étiquetage du matériel radio homologué: Le matériel pour lequel une certification a été obtenue mais qui n'est pas étiqueté conformément aux exigences ci-dessus (nom du requérant, numéro de modèle et numéro de certification) n'est pas considéré comme certifié.</small></p>	
Certification Body Code: DE0003	 recognised by Bundesnetzagentur
Blomberg, 29 September 2010	 Signed by / Signataire Uwe Dollitz
	Foreign Certification Body (FCB)
<small>BNetzA-CAB-04/22-53</small>	
<small>PHOENIX TESTLAB GmbH • Königswinkel 10 D-32825 Blomberg, Germany • Phone: +49 (0)5235-9500-0 • Fax: +49 (0) 5235-9500-10 http://www.phoenix-testlab.de</small>	

5.3.2 STM 332U / STM 333U IC Technical Approval Certificate



FCB under the Canada-EC MRA
 TCB under the USA-EC MRA
 RFCEAB under the Japan-EC MRA
 Notified Body R&TTE Directive 89/5/EC
 Notified Body EMC Directive 2004/108/EC

No. ► CA001349D

**TECHNICAL ACCEPTANCE
 CERTIFICATE
 CANADA**

**CERTIFICAT D'ACCEPTABILITÉ
 TECHNIQUE
 CANADA**

CERTIFICATION No. ► 5713A-STM332U
 No. DE CERTIFICATION
 ISSUED TO ► EnOcean GmbH
 DÉLIVRÉ A
 Street Address ► Kolpingring 18 a
 Numéro et rue
 Province or State ► Germany
 Province ou État

City ► Oberhaching
 Ville
 Postal Code ► 82041
 Code postal

TYPE OF EQUIPMENT ► Remote Control Device
 GENRE DE MATÉRIEL ► Limited Modular Approval
 ANTENNA ► Integrated
 ANTENNE ► Incorporé

TRADE NAME & MODEL ► Transmitter Modules STM 330U,
 MARQUE ET MODELE ► STM 331U, STM 332U, STM 333U
 ANTENNA GAIN ►
 GAIN D'ANTENNE ►

FREQUENCY RANGE BANDE DE FRÉQUENCES	EMISSION TYPE GENRE D'ÉMISSION	R.F. POWER PUISSANCE H.F.	SPECIFICATION/ ISSUE/ DATE SPÉCIFICATION/ ÉDITION/ DATE
902.88 - 902.88 MHz	323K7F1DAN	70.18 dBµV/m @ 3m	RSS-210 8 11 Dec 2010
902.88 - 902.88 MHz	322K1F1DAN	66.58 dBµV/m @ 3m	RSS-210 8 11 Dec 2010

TEST LABORATORY ► EMCCons DR. RAŠEK GmbH & Co. KG
 LABORATOIRE D'ESSAI
 Street Address ► Moggast, Boelwiese 8
 Numéro et rue
 Province or State ► Germany
 Province ou État
 Name ► Karlheinz Kraft
 Nom
 E-mail ► k.kraft@emcc.de

CN 3464C OATS 3464C-1
 City ► Ebermannstadt
 Ville
 Postal Code ► 91320
 Code postal
 Tel 0049 0194 9016
 Fax 0049 0194 8125

Certification of equipment means only that the equipment has met the requirements of the above-noted specification. Licence applications, where applicable to use certified equipment, are acted on accordingly by the Industry Canada issuing office and will depend on the existing radio environment, service and location of operation. This certificate is issued on condition that the holder complies and will continue to comply with the requirements and procedures issued by Industry Canada. The equipment for which this certificate is issued shall not be manufactured, imported, distributed, leased, offered for sale or sold unless the equipment complies with the applicable technical specifications and procedures issued by Industry Canada.

La certification du matériel signifie seulement que le matériel a satisfait aux exigences de la norme indiquée ci-dessus. Les demandes de licences nécessaires pour l'utilisation du matériel certifié sont traitées en conséquence par le bureau de délivrance d'Industrie Canada et dépendent des conditions radio ambiantes, du service et de l'emplacement d'exploitation. Le présent certificat est délivré à la condition que le titulaire satisfasse et continue de satisfaire aux exigences et aux procédures d'Industrie Canada. Le matériel à l'égard duquel le présent certificat est délivré ne doit pas être fabriqué, importé, distribué, loué, mis en vente ou vendu à moins d'être conforme aux procédures et aux spécifications techniques applicables publiées par Industrie Canada.

I hereby attest that the subject equipment was tested and found in compliance with the above-noted specification.

J'atteste par la présente que le matériel a fait l'objet d'essai et jugé conforme à la spécification ci-dessus.

DATE 21 June 2013

Certification Officer

5.3.3 Industry Canada Regulatory Statements

This device complies with Industry Canada licence-exempt RSS standard(s). Operation is subject to the following two conditions: (1) this device may not cause interference, and (2) this device must accept any interference, including interference that may cause undesired operation of the device.

Le présent appareil est conforme aux CNR d'Industrie Canada applicables aux appareils radio exempts de licence. L'exploitation est autorisée aux deux conditions suivantes: (1) l'appareil ne doit pas produire de brouillage, et (2) l'utilisateur de l'appareil doit accepter tout brouillage radioélectrique subi, même si le brouillage est susceptible d'en compromettre le fonctionnement.

IMPORTANT! Tous les changements ou modifications pas expressément approuvés par la partie responsable de la conformité ont pu vider l'autorité de l'utilisateur pour actionner cet équipement.

This Class B digital apparatus complies with Canadian ICES-003.
Cet appareil numérique de la classe B est conforme à la norme NMB-003 du Canada

6 Label Information

