

Transceiver Module
TCM 300 / TCM 300C / TCM 300U
TCM 320 / TCM 320C / TCM 320U

July 22, 2014



Observe precautions! Electrostatic sensitive devices!

Patent protected:
WO98/36395, DE 100 25 561, DE 101 50 128,
WO 2004/051591, DE 103 01 678 A1, DE 10309334,
WO 04/109236, WO 05/096482, WO 02/095707,
US 6,747,573, US 7,019,241

REVISION HISTORY

The following major modifications and improvements have been made to the first version of this document:

No	Major Changes
1.01	Tape running direction added in 3.8
1.02	Dimension of TCM 320 corrected (width 18 mm instead of 19 mm)
1.03	Editorial changes
1.10	Timing information regarding serial protocol added in A.2, A.3. 0xFFFF_FFFF excluded from usable ID range, because this ID will be used as broadcast ID.
1.20	Error corrected in 3.2.1. and 4.1: Maximum gain of external antenna at 50 Ohm output RF_50 is 0 dBi! Error corrected in 2.2: WXODIO is configured as output and provides information on VON signal
1.21	Note added in 3.5
1.25	Remarks added regarding use of IOVDD in 2.2.; Antenna specification in 3.3.1 extended. Updated information on conducted output power in 1.2; A.2.2 changed to point to EnOcean Alliance Website; A.2.3 and A.2.4 removed; editorial changes
1.26	Start-up time added in 1.2; Layout recommendations improved in 3.6
1.27	Antenna recommendations removed and referred to application note AN102 and AN105; Maximum Rating for IOVDD modified (IOVDD may now exceed VDD); Chapter "Related Documents" added; figure added in 3.2.1; parameters for antenna requirements relaxed in 4.2.1.; pin numbers added in 3.2; Update of FCC grants in 5.2; TCM 320 drawing modified in 2.3.
1.29	New module variants for 902.875 MHz
1.30	Several Changes to meet FCC and IC manual requirements for Limited Modular Approval
1.31	Editorial changes
1.32	Mitsubishi Materials Chip Antenna added to limited modular approval
1.4	Recommended reset / programming pin circuitry added
1.41	Minor corrections in TCM320U IC certificate number
1.42	Update of recommended power supply filter components
1.43	Added duty-cycle lock in 5.1

Published by EnOcean GmbH, Kolpingring 18a, 82041 Oberhaching, Germany
www.enocean.com, info@enocean.com, phone +49 (89) 6734 6890

© EnOcean GmbH, All Rights Reserved

Important!

This information describes the type of component and shall not be considered as assured characteristics. No responsibility is assumed for possible omissions or inaccuracies. Circuitry and specifications are subject to change without notice. For the latest product specifications, refer to the EnOcean website: <http://www.enocean.com>.

As far as patents or other rights of third parties are concerned, liability is only assumed for modules, not for the described applications, processes and circuits.

EnOcean does not assume responsibility for use of modules described and limits its liability to the replacement of modules determined to be defective due to workmanship. Devices or systems containing RF components must meet the essential requirements of the local legal authorities.

The modules must not be used in any relation with equipment that supports, directly or indirectly, human health or life or with applications that can result in danger for people, animals or real value.

Components of the modules are considered and should be disposed of as hazardous waste. Local government regulations are to be observed.

Packing: Please use the recycling operators known to you.

TABLE OF CONTENT

1	MODULE VARIANTS AND RELATED DOCUMENTS	5
2	GENERAL DESCRIPTION	6
	2.1 Basic functionality	6
	2.2 Technical data TCM 300 / TCM 320 (868.300 MHz)	7
	2.3 Technical data TCM 300C / TCM 320C (315.000 MHz)	8
	2.4 Technical data TCM 300U/ TCM 320U (902.875 MHz)	8
	2.5 Physical dimensions TCM 300x	9
	2.6 Physical dimensions TCM 320x	9
	2.7 Environmental conditions.....	10
	2.8 Ordering information.....	10
3	FUNCTIONAL DESCRIPTION	11
	3.1 Pin out	11
	3.2 Pin description and operational characteristics.....	12
	3.2.1 GPIO supply voltage - IOVDD.....	14
	3.3 Absolute maximum ratings (non operating)	15
	3.4 Maximum ratings (operating)	15
	3.5 Operating modes	16
	3.6 Mode selection	17
	3.7 Repeater configuration	18
	3.8 Suggested reset and programming input circuitry	19
	3.9 Teach-in procedure.....	19
	3.9.1 Setting the receiver to learning mode	19
	3.9.2 Confirmation of Learning Mode	20
	3.9.3 Teaching in a transmitter.....	20
	3.9.4 Confirmation of correct learning/deletion	20
	3.9.5 Learning of further transmitters.....	20
	3.9.6 Selecting the next channel.....	21
	3.9.7 Leaving learning mode	21
	3.9.8 Deleting a transmitter	21
	3.10 Remote management.....	21
	3.10.1 Remote Management Control Commands (RMCC).....	21
	3.10.2 Remote Procedure Calls (RPC).....	22
	3.11 Smart Acknowledge	23
	3.12 Transmit timing.....	23
4	APPLICATIONS INFORMATION.....	24
	4.1 Transmission range	24
	4.2 Antenna options TCM 300x	25
	4.2.1 Overview.....	25
	4.2.2 Whip antenna.....	25
	4.2.3 Helical antenna (supplier: EnOcean)	26
	4.2.4 Chip antenna (supplier: Mitsubishi Material, Type AM11DG-ST01)	27
	4.3 Antenna options TCM 320x	28
	4.3.1 Positioning of the whip antenna	29
	4.3.2 Mounting 50 Ω antennas.....	29
	4.4 Recommendations for laying a whip antenna.....	31
	4.5 Power supply requirements.....	32
	4.6 Layout recommendations	32
	4.6.1 TCM 300x recommended foot pattern	33

- 4.7 Soldering information..... 36
 - 4.7.1 TCM 300x..... 36
 - 4.7.2 TCM 320x..... 37
- 4.8 Tape & Reel specification TCM 300x..... 37
- 4.9 Backward compatibility to TCM 220C..... 38
- 4.10 Using RVDD 38
- 4.11 Voltage dips..... 38
- 5 AGENCY CERTIFICATIONS 39
 - 5.1 CE approval 39
 - 5.2 FCC (United States) Certification 40
 - 5.3 IC (Industry Canada) Certification 43
 - 5.4 FCC Regulatory Statements 44
 - 5.5 Industry Canada Regulatory Statements 45
- A Serial Interface 46
 - A.1 EnOcean serial protocol 46
 - A.1.1 Message format (ESP2) 46
 - A.1.2 Byte signals and bit order 46
 - A.1.3 Description of serial data structure 47
 - A.2 Radio transmission/reception commands 48
 - A.2.1 Detailed description of ORG, DATA_BYTE, and STATUS fields 48
 - A.3 Command telegrams and messages..... 49
 - A.3.1 ID Range commands..... 49
 - A.3.2 Receiver sensitivity commands..... 49
 - A.3.3 Reset command 49
 - A.3.4 SW Version 49
 - A.3.5 Error messages 50
 - A.3.6 Command Encoding 51

TCM 300 / TCM 300C / TCM 300U
TCM 320 / TCM 320C / TCM 320U

1 MODULE VARIANTS AND RELATED DOCUMENTS

This document describes operation of TCM 300 and TCM 320 modules available in variations for following frequencies:

- TCM 300 / TCM 320: 868.300 MHz
- TCM 300C / TCM 320C: 315.000 MHz
- TCM 300U / TCM 320U: 902.875 MHz

In side this manual the following terms TCM 300x or TCM 320x can be used interchangeably for any of the above frequency, and the term TCM 3x0 can be used for each frequency and module number listed above.

If you want to write own firmware running on the integrated micro controller or need more detailed information on the Dolphin core please also refer to

- [Dolphin Core Description](#)
- [Dolphin API Documentation](#)

In addition we recommend following our [application notes](#), in particular:

- AN101: Power Supply Layout – Layout considerations for Line-Power
- AN102: Antenna Basics – Basic Antenna Design Considerations for EnOcean based Products
- AN105: 315 MHZ Internal Antenna Design – Considerations for EnOcean based Products
- AN403: Dolphin Migration - Replacing RCM 1xy / TCM 1x0 / TCM 2x0C by TCM 3x0



2 GENERAL DESCRIPTION

2.1 Basic functionality

The transceiver modules TCM 300x and TCM 320x enable the realization of highly efficient RF repeaters and transceivers for the EnOcean radio systems. The module provides several built-in operating modes. In addition repeater functionality (1 or 2 level) can be activated. Using the Dolphin API library it is possible to write custom software for the module. All module variants are in-system programmable.

Built-in operating modes

- Unidirectional / bidirectional serial communication
- 1-channel / 4 channel relay mode
- 1-channel dimming mode

Product variants

TCM 300x: SMD mountable module for use with external antenna

- TCM 300 868.300 MHz
- TCM 300C 315.000 MHz
- TCM 300U 902.875 MHz

TCM 320x: Variant for vertical mounting with pin connector and whip antenna.

- TCM 320 868.300 MHz
- TCM 320C 315.000 MHz
- TCM 320U 902.875 MHz

Features accessible via API:

- Integrated 16 MHz 8051 CPU with 32 kB FLASH and 2 kB SRAM
- Various power down and sleep modes
 - TCM 300x down to 0.2 μ A current consumption
 - TCM 320x down to 1.4 mA current consumption
- Up to 14 configurable I/Os (TCM 300x)
- 10 bit ADC, 8 bit DAC

TCM 300 / TCM 300C / TCM 300U
 TCM 320 / TCM 320C / TCM 320U

2.2 Technical data TCM 300 / TCM 320 (868.300 MHz)

Antenna	TCM 320 : 8.6 cm whip TCM 300: whip or 50 Ω antenna mountable
Frequency	868.300 MHz
Radio Standard (Modulation)	ASK ¹⁾
Data rate	125 kbps
Receiver Sensitivity (25 °C) ²⁾	typ. -96 dBm ²⁾
Conducted Output Power @50 Ω min / typ / max	TCM 300: 3.0 dBm / 5.7 dBm / 7.0 dBm TCM 320: 1.2 dBm / 3.1 dBm / 5.2 dBm
Power Supply	TCM 320: 2.6 V–3.3 V TCM 300: 2.6 V–4.5 V
Start-up time	<500 ms
Current Consumption	Receive mode: typ. 33 mA, max. 43 mA Transmit mode: typ. 24 mA, max. 33 mA
Radio Regulations	R&TTE EN 300 220-2: v2.4.1

1) according to ISO/IEC 14543-3-10

2) @ 0.1% telegram error rate (based on 3 transmitted sub-telegrams)

TCM 300 / TCM 300C / TCM 300U
 TCM 320 / TCM 320C / TCM 320U

2.3 Technical data TCM 300C / TCM 320C (315.000 MHz)

Antenna	TCM 320C: 15 cm mounted whip antenna TCM 300: whip or 50 Ω antenna mountable
Frequency	315.000 MHz
Radio Standard (Modulation)	ASK ¹⁾
Data rate	125 kbps
Receiver Sensitivity (25 °C)	typ. -98 dBm ²⁾
Conducted Output Power @50 Ω min / typ / max	TCM 300C: 5.5 dBm / 7.5 dBm / 9.5 dBm TCM 320C: 3.5 dBm / 5.5 dBm / 7.5 dBm
Power Supply	TCM 320C: 2.6 V–3.3 V TCM 300C: 2.6 V–4.5 V
Start-up time	<500 ms
Current Consumption min / typ / max	Receive mode: typ. 33 mA, max. 43 mA Transmit mode: typ. 24 mA, max. 33 mA
Radio Regulations	FCC CFR-47 Part 15 (US) IC (Canada)

1) according to ISO/IEC 14543-3-10

2) @ 0.1% telegram error rate (based on 3 transmitted sub-telegrams)

2.4 Technical data TCM 300U/ TCM 320U (902.875 MHz)

Antenna	TCM 320U: 6.4 cm whip mounted whip antenna TCM 300U: whip or 50 Ω antenna mountable
Frequency	902.875 MHz
Radio Standard (Modulation)	FSK
Data rate	125 kbps
Receiver Sensitivity (25 °C) ³⁾	typ. -98 dB ³⁾
Conducted Output Power @50 Ω ⁴⁾ min / typ / max	-1 dBm / +1 dBm / +3 dBm
Power Supply	TCM 320U: 2.6 V–3.3 V TCM 300U: 2.6 V–4.5 V
Start-up time	<500 ms
Current Consumption min / typ / max	Receive mode: typ. 33 mA, max. 43 mA Transmit mode: typ. 24 mA, max. 33 mA
Radio Regulations	FCC CFR-47 Part 15 (US) IC (Canada)

3) @ 0.1% telegram error rate (based on transmitted sub-telegrams)

4) using +1dBm (V 1.13) power settings which comply to limited modular approval

TCM 300 / TCM 300C / TCM 300U
TCM 320 / TCM 320C / TCM 320U

2.5 Physical dimensions TCM 300x

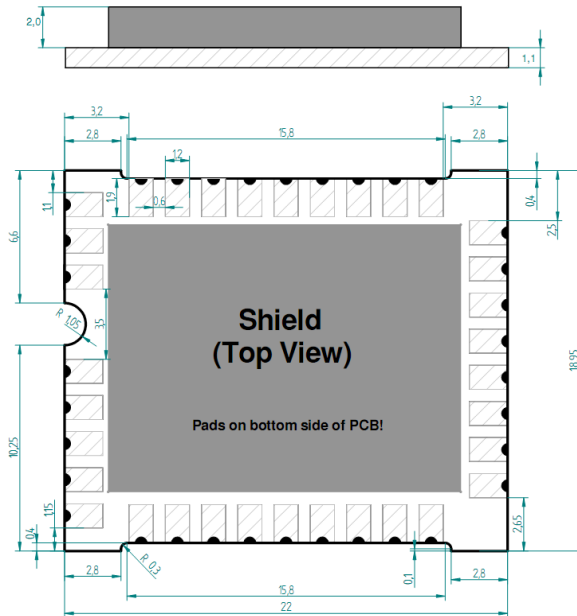

Unless otherwise specified dimensions are in mm.

Tolerances:
PCB outline dimensions ± 0.2 mm
All other tolerances ± 0.1 mm

TCM 300x (pads on bottom side of PCB!)

2.6 Physical dimensions TCM 320x

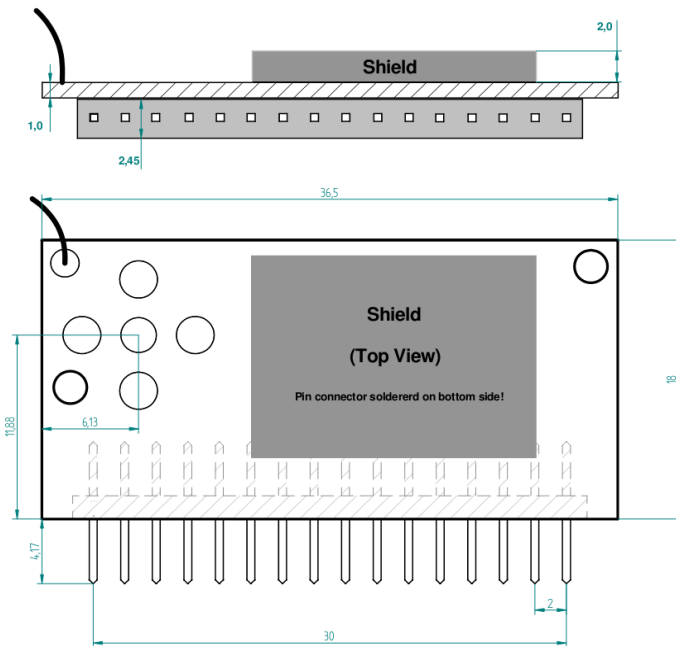

Unless otherwise specified dimensions are in mm.

Tolerances:
PCB outline dimensions ± 0.2 mm
All other tolerances ± 0.1 mm

TCM 320x pin connectors

TCM 300 / TCM 300C / TCM 300U
 TCM 320 / TCM 320C / TCM 320U

PCB dimensions	TCM 320x (without pin connector): 36.5 x 18 x 5.5 mm TCM 300x: 22 x 19 x 3.1 mm
Pin connector	16 pins, grid 2.0 mm (4.0 mm in length, \uparrow 0.5 mm)
Weight	TCM 320x: 3.7 g TCM 300x: 1.9 g

2.7 Environmental conditions

Operating temperature	-25 °C ... +85 °C
Storage temperature	-40 °C ... +85 °C
Storage temperature in tape & reel package	-20 °C ... +50 °C
Humidity	0% ... 93% r.H., non-condensing

2.8 Ordering information

Type	Ordering Code	Frequency
TCM 300	S3003-K300	868.300 MHz
TCM 320	S3003-K320	868.300 MHz
TCM 300C	S3033-K300	315.000 MHz
TCM 320C	S3033-K320	315.000 MHz
TCM 300U	S3053-K300	902.875 MHz
TCM 320U	S3053-K320	902.875 MHz

TCM 300 / TCM 300C / TCM 300U
 TCM 320 / TCM 320C / TCM 320U

3 FUNCTIONAL DESCRIPTION

3.1 Pin out

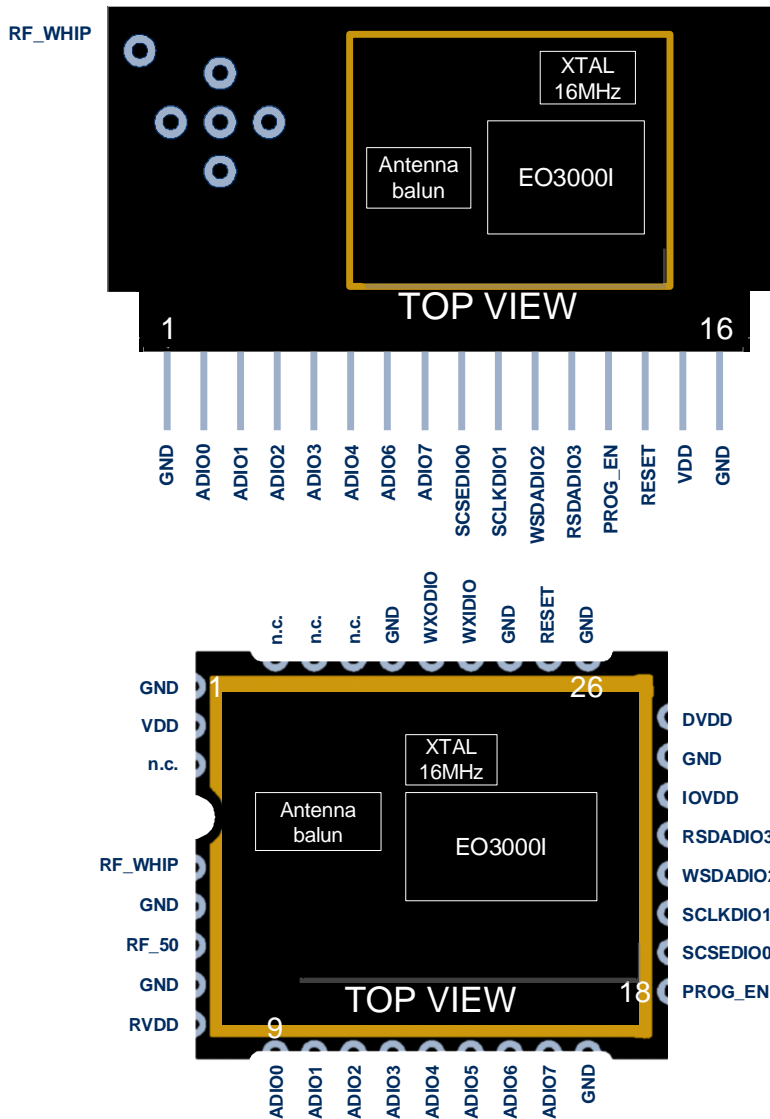

The figure above shows the pin out of the TCM 300x / TCM 320x hardware. The pins are named according to the naming of the Dolphin chip to simplify usage of the DOLPHIN API. The table in section 3.2 shows the translation of hardware pins to a naming that fits the functionality of the built-in firmware. When writing own firmware based on the DOLPHIN API please refer to the [Dolphin Core Description](#) and use this manual only for information regarding the module hardware, such as pin out, layout recommendations, power supply requirements, antenna options, and approvals.

3.2 Pin description and operational characteristics

HW Symbol	TCM 300x pin #	TCM 320x pin #	Function	Characteristics
GND	1, 5, 7, 17, 24, 26, 28, 31	1, 16	Ground connection	Must be connected to GND; see 4.5
VDD	2	15	Supply voltage	TCM 300: 2.6 V – 4.5 V TCM 320: 2.6 V – 3.3 V Max. ripple: see 3.4
RVDD	8		RF supply voltage regulator output	1.8 V Output current: <ul style="list-style-type: none"> ■ max. 100 μA with built-in firmware (RX on) ■ max. 10 mA while not in RX/TX mode
DVDD	25		Digital supply voltage regulator output	1.8 V Output current: max. 5 mA
IOVDD	23		GPIO supply voltage	TCM 320: internally connected to VDD TCM 300: Must be connected to desired interface supply voltage (see 3.4) See also 3.2.1.
RESET	27	14	Reset input Programming I/F	Active high reset. External 10 k Ω pull-down parallel to 10nF capacitor recommended.
PROG_EN	18	13	Programming I/F	HIGH: programming mode active LOW: operating mode Digital input, external 10 k Ω pull-down parallel to 10nF capacitor recommended.
ADIO0	9	2	MODE_SEL	Analog input: At start-up input voltage is measured and mode is selected. See chapter 3.6.
ADIO1	10	3	MODE 0: not used	In mode 0 the repeater level is 1 and cannot be modified.
			MODE 1-4: REP_LEVEL	Mode 1-4: At start-up the repeater level is selected: Repeater level 1: LOW Repeater level 2: HIGH Digital input, internal pull-up active
ADIO2	11	4	REPEATER	At start-up the repeater can be switched on: Repeater on: LOW Repeater off: HIGH Digital input, internal pull-up active
ADIO3	12	5	MODE 0: Sensitiv-	Low sensitivity: LOW

			ity	High sensitivity: HIGH Digital input, internal pull-up active
			MODE 1-4: LRN	Enter/leave teach-in mode. See chapter 3.8 Digital input, internal pull-up active
ADIO4	13	6	MODE 0: not used	Internal pull-up active
			MODE 1-4: CLR	Clear ID memory. See chapter 3.8 Digital input, internal pull-up active
ADIO5	14		Not used	Digital output, internally set to LOW
ADIO6	15	7	MODE 0-1: SER_RX	UART input
			MODE 2-4: not used	Digital input, internal pull-up active
ADIO7	16	8	MODE 0-1: SER_TX	UART output Max. output current: 2 mA @ IOVDD=3.3 V 0.65 mA @ IOVDD=1.8 V
			MODE 2-3: CHANNEL0	Digital output channel 0 Max. output current: 2 mA @ IOVDD=3.3 V 0.65 mA @ IOVDD=1.8 V
			MODE 4: not used	Digital output, internally set to LOW
			Programming I/F	
SCSEDIO0	19	9	MODE 0, 2: not used	Digital output, internally set to LOW
			MODE 1: LRN_TOGGLE	Digital output Max. output current: 2 mA @ IOVDD=3.3 V 0.65 mA @ IOVDD=1.8 V
			MODE 3: CHANNEL1	Digital output channel 1 Max. output current: 2 mA @ IOVDD=3.3 V 0.65 mA @ IOVDD=1.8 V
			MODE 4: PWM	Dimmer output, 50 kHz
			Programming I/F	
SCLKDIO1	20	10	MODE 0-2: not used	Digital output, internally set to LOW
			MODE 3: CHANNEL2	Digital output channel 2 Max. output current: 2 mA @ IOVDD=3.3 V 0.65 mA @ IOVDD=1.8 V
			MODE 4: PWM_IND	Indicating if PWM is active. Digital output. Max. output current: 2 mA @ IOVDD=3.3 V 0.65 mA @ IOVDD=1.8 V
			Programming I/F	
WSDADIO2	21	11	MODE 0-2, 4: not	Digital output, internally set to LOW

			used	
			MODE 3: CHANNEL3	Digital output channel 3 Max. output current: 2 mA @ IOVDD=3.3 V 0.65 mA @ IOVDD=1.8 V
			Programming I/F	
RSDADIO3	22	12	MODE 0: RMI	Normal operation: Digital output, internally set to LOW Remote Management: ACTION command indicator (see 3.10.1) Max. output current: 2 mA @ IOVDD=3.3 V 0.65 mA @ IOVDD=1.8 V
			MODE 1-4: LMI	Normal operation: Learn mode indicator Remote Management: ACTION command indicator (see 3.10.1) Digital output Max. output current: 2 mA @ IOVDD=3.3 V 0.65 mA @ IOVDD=1.8 V
			Programming I/F	
WXIDIO	29		Not used	Digital output, internally set to LOW
WXODIO	30		Not used	Digital output, HIGH if VDD>VON, LOW if VDD<VON, see also 4.11
RF_WHIP	4		RF output	Output for whip antenna
RF_50	6		RF output	50 Ohm output for external antenna
n.c.	3, 32,33, 34		Not connected	Do not connect!

For more details regarding I/Os please refer to [Dolphin Core Description](#).

3.2.1 GPIO supply voltage - IOVDD

For digital communication with other circuitry (peripherals) the digital I/O configured pins of the mixed signal sensor interface (ADIO0 to ADIO7) and the pins of the serial interface (SCSEDIO0, SCLKDIO1, WSDADIO2, RSDADIO3) may be operated from supply voltages different from DVDD. Therefore an interface voltage supply pin IOVDD is available which must be connected either to DVDD or to an external supply within the tolerated voltage range of IOVDD.



If DVDD=0 V (e.g. in any sleep mode or if VDD<VOFF) and IOVDD is supplied, there may be unpredictable and varying current from IOVDD caused by internal floating nodes. It must be taken care that the current into IOVDD does not exceed 10 mA while DVDD=0 V.

If DVDD=0 V and IOVDD is not supplied, do not apply voltage to any above mentioned pin. This may lead to unpredictable malfunction of the device.

Inside TCM 320x the signals VDD and IOVDD are internally connected! Therefore the above mentioned issues have to be considered when writing own firmware based on API.



For I/O pins configured as analogue pins the IOVDD voltage level is not relevant! However it is important to connect IOVDD to a supply voltage as specified in 3.4.

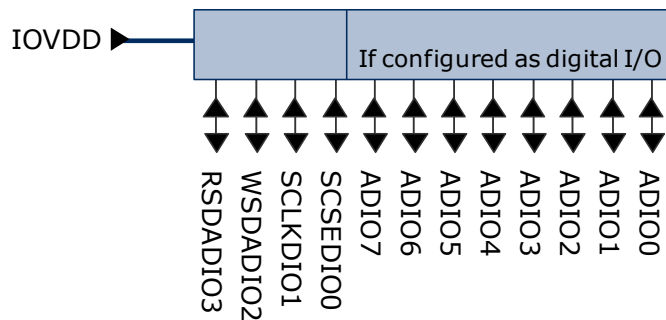

3.3 Absolute maximum ratings (non operating)

Symbol	Parameter	Min	Max	Units
VDD	Supply voltage at VDD TCM 300x	-0.5	5.5	V
	TCM 320x (limitation due to internal VDD-IOVDD connection)	-0.5	3.6	V
IOVDD	GPIO supply voltage	-0.5	3.6	V
GND	Ground connection	0	0	V
VINA	Voltage at every analog input pin	-0.5	2	V
VIND1	Voltage at RESET, and every digital input pin except WXIDIO/WXODIO	-0.5	3.6	V
VIND2	Voltage at WXIDIO / WXODIO input pin	-0.5	2	V

3.4 Maximum ratings (operating)

Symbol	Parameter	Min	Max	Units
VDD	Supply voltage at VDD TCM 300	2.6	4.5	V
	TCM 320	2.6	3.3	V
IOVDD	GPIO supply voltage (see also 3.2.1)	1.7	3.6	V
GND	Ground connection	0	0	V
VINA	Voltage at every analog input pin	0	2.0	V
VIND1	Voltage at RESET, and every digital input pin except WXIDIO / WXODIO	0	3.6	V
VIND2	Voltage at WXIDIO / WXODIO input pin	0	2.0	V
VDDR	Max. ripple at VDD		50	mVpp

3.5 Operating modes

Mode	Function	Output signal description	No. of channels
0	Unidirectional serial interface compatible with TCM 220C, no teach-in capability	SER_TX: UART output, supplies standard data blocks of information from all received EnOcean radio telegrams (9600 bps; 8 data bits, no parity bit, one start bit, one stop bit). For further information see chapter A.1	
1	Bidirectional serial interface, teach-in capability for up to 30 entries ¹	SER_RX, SER_TX: Asynchronous bidirectional Interface, supplies standard data blocks of information from all received EnOcean radio telegrams (9600 bps; 8 data bits, no parity bit, one start bit, one stop bit). For further information see chapter A.1 LRN_TOGGLE: Learning mode status indicator	
2	Rocker Switch - 1 channel, teach-in capability for up to 30 entries ¹	Supplies the desired logic switching state "on/off" at CHANNEL0 when pushing the switch rockers	1
3	Rocker Switch - 4 channels, teach-in capability for up to 30 entries ²	Same as Mode 2 but operation of 4 receiver channels (CHANNEL0, CHANNEL1, CHANNEL2, CHANNEL3)	4
4	Dimming - 1 channel, teach-in capability for up to 30 entries ¹	PWM is the PWM output <ul style="list-style-type: none"> ■ I-button pressed for shorter than 0.5 s: ON (Restore duty cycle stored before last switch-off). ■ O-button pressed for shorter than 0.5 s: OFF ■ O-/I-button pressed longer than 0.5 s: Duty cycle variation from 10% up to 100% (O=less, I=more; ~300 PWM steps, increment every 15 ms). Duty cycle variation stops when button is released. PWM_IND is active as long as duty cycle is not 0%	1
5	Reserved		

¹ Each rocker of a PTM transmitter is counted as 1 entry

² Each rocker is counted as 1 entry. If the same rocker is teach into several channels, 1 entry per channel is needed.

3.6 Mode selection

The operating mode is defined at start-up of the module via a measurement of the voltage at ADIO0.



As long as IDs are stored in ID memory, the operating mode can only be changed after deleting all IDs from memory, e.g. via CLR!

Mode	ADIO0 (MODE_SEL) input voltage range	Proposed component values
0	0% to 3.99% VDD	R1: 0 Ohm R2: leave open R3: leave open C1: leave open
1	4% to 11.99% VDD	R1: 1k2 ±1% R2: 15k ±1% R3: 150k ±1% C1: 100p
2	12% to 19.99% VDD	R1: 2k2 ±1% R2: 12k ±1% R3: 270k ±1% C1: 100p
3	20% to 27.99% VDD	R1: 3k9 ±1% R2: 15k ±1% R3: 68k ±1% C1: 100p
4	28% to 35.99% VDD	R1: 4k7 ±1% R2: 12k ±1% R3: 56k ±1% C1: 100p
5	36% to 39.99% VDD	R1: 5k6 ±1% R2: 10k ±1% R3: 56k ±1% C1: 100p

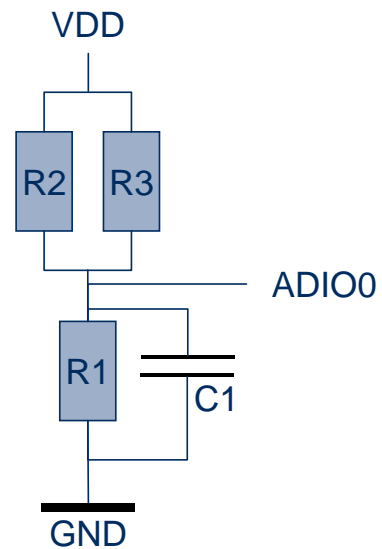

3.7 Repeater configuration

TCM 3x0 provides the option to activate a one or two-level repeater for EnOcean radio telegrams.

1-level repeater: If a received telegram is a valid and original (not yet repeated), the telegram is repeated after a random delay.

2-level repeater: If a received telegram is valid and original or repeated once, the telegram is repeated after a random delay.



2-level repeating function should only be activated if really needed! Otherwise the system function can be compromised by collisions of telegrams.

The repeated telegram is marked as "repeated" by an increased repeater counter.

Setting the repeater level:

At start-up of the module repeater on/off and repeater level are determined. Please refer to the table in 3.2 regarding the configuration options.



Please note that in Mode 0 2-level repeating is not possible (for backward compatibility to TCM 220C)!

The figure below shows the basic circuit for a stand-alone repeater.

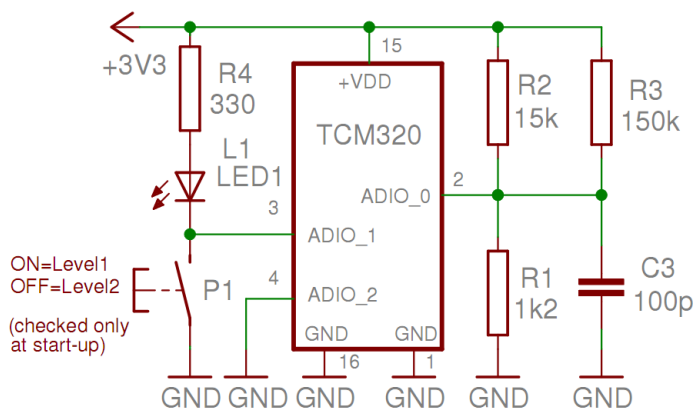

3.8 Suggested reset and programming input circuitry

In order to ensure reliable operation it is recommended to connect both the reset and the programming input with a 10 kΩ resistor in parallel with a 10 nF capacitor to ground. This avoids spurious signal detection in very noisy environments and in situations where an external programming header is provided.

The suggested circuit is shown below.

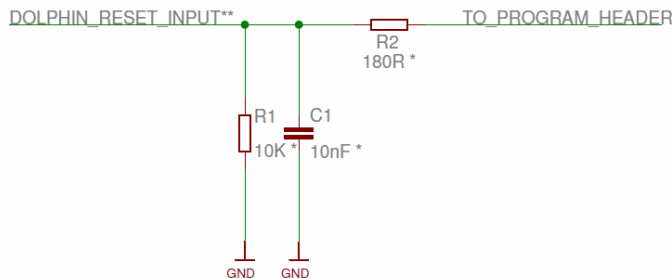

* values may be different depending on the application

** same circuit recommended for PROG_EN Input

3.9 Teach-in procedure

Modes 1 to 4 support teach-in of transmitters.



Please make sure not to remove supply voltage while in LRN mode! The flash content could get corrupted!

3.9.1 Setting the receiver to learning mode

- **Via CLR Pin (ADIO4):** Contact to GND longer than $t = 2$ seconds. Learning Mode LRN is entered after clearing ID memory.
- **Via LRN Pin (ADIO3):** Contact to GND longer than $t = 0.5$ seconds. In multi-channel receiver mode, the pin has to be contacted several times until the desired channel number is selected (the number of channels is given by the selected operating mode).
- **Via Remote Config Control:** Please refer to documentation of remote management.

3.9.2 Confirmation of Learning Mode

Mode	Confirmation
0	No Learn capability
1	LMI HIGH continuously, LRN_TOGGLE toggling every 1 s.
2	LMI HIGH continuously, CHANNEL0 toggling every 1 s.
3	LMI HIGH continuously, current CHANNELx toggling every 1 s.
4	LMI HIGH continuously, DIM IND HIGH, and PWM toggling every 1 s between 10% and 100%
5	Reserved for future use

3.9.3 Teaching in a transmitter

In learning mode LRN, the sensitivity of the module is limited to in-room operations and learning of repeater powered signals is disabled (to avoid unintentional learning). Therefore ensure that the associated radio transmitter will be in a distance less than 5m to the receiver (not necessary within Remote Learn Mode).

Trigger the telegram of the associated radio transmitter within 30 seconds:

- Operate the switch radio transmitter (RPS or HRC) at least once (press I-button or O-button of the rocker that is to be assigned to the selected receiver channel). If the same rocker is operated again within 4 seconds it will still be learned. If the same rocker is operated again after more than 4 seconds it will be deleted again. Please note that teach-in without rocker information is not possible" Please note that scene switches (HRC and last 3 ID bits 0B111) cannot be teach-in!
- Or activate the sensor radio transmitter (1BS, 4BS) least once with active LRN bit (DI_3=0, please refer to "Standardization EnOcean Communication Profiles"). If the same transmitter is operated again after more than 4 seconds with active LRN bit it will be deleted again.



Please note that in modes 2, 3, and 4 only RPS or HRC telegrams can be learned!

3.9.4 Confirmation of correct learning/deletion

The output which is toggling every second while in teach-in mode (see above) will stay switched high for 4 seconds to signal that a transmitter has been learned. In case a transmitter ID has been deleted it will stay 4 seconds low.

3.9.5 Learning of further transmitters

After confirmation, the receiver changes again to readiness for learning. Further transmitters can be learned immediately. If available the next receiver channel can be entered by connecting the LRN pin to GND longer than $t = 0.5$ seconds. A maximum of 30 radio transmitters can be learned (further attempts will be ignored; instead of learning confirmation, operating mode is entered). Each rocker of a radio transmitter is counted as one transmitter.

3.9.6 Selecting the next channel

By fresh contacting of the LRN pin to GND the next remaining channel is selected. In one-channel mode or after the last channel, the operating mode is entered again.

3.9.7 Leaving learning mode

LRN mode is left in either one of the following events:

- Output of last available channel is toggling and a fresh contacting of the LRN pin to GND for 0.5 seconds is performed
- No ID has been added/deleted during the last 30 seconds.
- Memory was full and another ID was sent to be learnt

3.9.8 Deleting a transmitter

Deletion of one specific transmitter: Use the same procedure as learning the associated transmitter.

As transmitter delete confirmation, the corresponding function outputs remain in inactive state for 4 seconds while LMI keeps active. After that, a wrongly deleted transmitter can be learned again immediately.



In order to delete a PTM transmitter the same rocker as during learn has to be operated. If several rockers of a PTM transmitter have been learned, all have to be deleted separately.

Deletion of all learned transmitters: Connect the CLR pin longer than 2 seconds to GND. All learned transmitters on all channels are deleted at the same time. After this, the receiver enters Learning Mode.

3.10 Remote management

TCM 3x0 supports the remote management specification which is available from EnOcean upon request. This allows controlling the teach-in procedure via a Remote Config Control device.

3.10.1 Remote Management Control Commands (RMCC)

All RMCCs supported.

Mode	Reaction to ACTION COMMAND (Function code 0x005)
0	RMI HIGH for 1 s.
1	LMI HIGH, and LRN_TOGGLE on for 1 s.
2	LMI HIGH, and CHANNEL0 invert for 1 s.
3	LMI HIGH, and all CHANNELx inverted for 1 s.
4	LMI HIGH, DIM IND inverted, and PWM inverted for 1 s.
5	Reserved for future use

3.10.2 Remote Procedure Calls (RPC)

Supported RPCs:

- Remote learn command, function code 0x201
- Smart ACK: Read mailbox settings, function code 0x205, settings type 0x01
- Smart ACK: Delete mailbox, function code 0x206, operation type 0x02

REMOTE LEARN COMMAND:

EEP: 0x000000

Mode	Flag in command	Reaction
0	n.a.	No reaction, no Learn Mode available
1	0x01 0x03	Start Remote Learn Mode Stop Remote Learn Mode
2	0x01 0x03	Start Remote Learn Mode Stop Remote Learn Mode
3	0x01 0x02 0x03	Start Remote Learn Mode Next channel Stop Remote Learn Mode
4	0x01 0x03	Start Remote Learn Mode Stop Remote Learn Mode
5	n.a.	No reaction, reserved for future use

The signalling is the same as described above in 3.8.

Differences between remote learn mode and normal learn mode:

- In remote learn mode also repeated telegrams will be accepted
- 3 transmissions within 2 seconds are required, instead of 1 transmission

For detailed information on remote management please refer to the Remote Management system specification.

3.11 Smart Acknowledge

TCM 3x0 modules provide a post master function with 15 mail boxes for systems using EnOcean smart acknowledge technology. This functionality is switched on in all operating modes.

For detailed information on smart acknowledge please refer to the Smart Acknowledge system specification.



When teaching-in a device using Smart Acknowledge please take care to switch off all TCM 3x0 devices which are not continuously powered. Otherwise these TCM 3x0 modules could be declared postmaster. As soon as the power supply is switched off a postmaster would be missing and Smart Acknowledge would not work any longer!

3.12 Transmit timing

The setup of the transmission timing allows avoiding possible collisions with data packages of other EnOcean transmitters as well as disturbances from the environment. With each transmission cycle, 3 identical subtelegrams are transmitted within 40 ms.

The transmission of a subtelegram lasts approximately 1.2 ms. The delay between the three transmission bursts is affected at random.

4 APPLICATIONS INFORMATION

4.1 Transmission range

The main factors that influence the system transmission range are type and location of the antennas of the receiver and the transmitter, type of terrain and degree of obstruction of the link path, sources of interference affecting the receiver, and “dead” spots caused by signal reflections from nearby conductive objects. Since the expected transmission range strongly depends on this system conditions, range tests should categorically be performed before notification of a particular range that will be attainable by a certain application.

The following figures for expected transmission range are considered by using a PTM, a STM or a TCM radio transmitter device and the TCM radio receiver device with preinstalled whip antenna and may be used as a rough guide only:

- Line-of-sight connections: Typically 30 m range in corridors, up to 100 m in halls
- Plasterboard walls / dry wood: Typically 30 m range, through max. 5 walls
- Line-of-sight connections: Typically 30 m range in corridors, up to 100 m in halls
- Ferro concrete walls / ceilings: Typically 10 m range, through max. 1 ceiling
- Fire-safety walls, elevator shafts, staircases and supply areas should be considered as screening.

The angle at which the transmitted signal hits the wall is very important. The effective wall thickness – and with it the signal attenuation – varies according to this angle. Signals should be transmitted as directly as possible through the wall. Wall niches should be avoided. Other factors restricting transmission range:

- Switch mounted on metal surfaces (up to 30% loss of transmission range)
- Hollow lightweight walls filled with insulating wool on metal foil
- False ceilings with panels of metal or carbon fibre
- Lead glass or glass with metal coating, steel furniture

The distance between EnOcean receivers and other transmitting devices such as computers, audio and video equipment that also emit high-frequency signals should be at least 0.5 m

A summarized application note to determine the transmission range within buildings is available as download from www.enocean.com.

4.2 Antenna options TCM 300x

4.2.1 Overview

Several antenna types have been investigated by EnOcean. Please refer to our application notes AN102, and AN105 which give an overview on our recommendations.

All TCM3x0 modules have been approved with whip antenna, and TCM300U with helical antenna in addition.

868.300 MHz modules used in Europe do not need additional approval if the external antenna fulfils the following requirements:

Frequency band	868.300 MHz ISM	Antenna must be suited for this band
Antenna type	Passive	Mandatory for radio approval
Impedance	~50 Ohm	Mandatory for radio approval
Maximum gain	≤ 0 dBd	Mandatory for radio approval

In addition it is important to fulfill the following requirements in order to achieve compatibility with other EnOcean products and to ensure excellent EMI robustness:

VSWR	≤ 3:1	Important for compatibility with EnOcean protocol
Return Loss	> 6 dB	Important for compatibility with EnOcean protocol
Bandwidth	≤ 20 MHz	Important if 10 V/m EMI robustness required for device



For 315 MHz / 902.875 MHz modules (TCM 300C / TCM 300U) please note that a full approval is needed if modules are used with antennas other than the specified antennas.

4.2.2 Whip antenna

315 MHz

Antenna: 150 mm wire, connect to RF_WHIP
Minimum GND plane: 50 mm x 50 mm
Minimum distance space: 10 mm

868.3 MHz

Antenna: 86 mm wire, connect to RF_WHIP
Minimum GND plane: 38 mm x 18 mm
Minimum distance space: 10 mm

902.875 MHz

Antenna: 64 mm wire, connect to RF_WHIP
Minimum GND plane: 50 mm x 50 mm
Minimum distance space: 10 mm

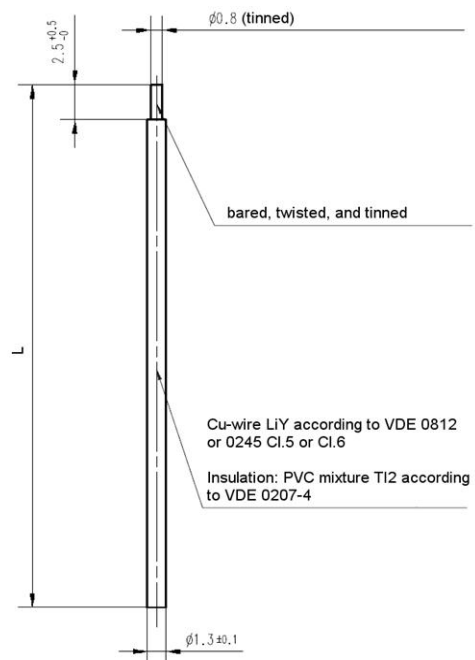

TCM 300 / TCM 300C / TCM 300U
 TCM 320 / TCM 320C / TCM 320U

4.2.3 Helical antenna (supplier: EnOcean)

315 MHz

Please contact EnOcean for availability.

868.3 MHz

Design according to drawing below, connect to RF_WHIP.
 Please contact EnOcean for MOQ.
 Minimum GND plane: 35 mm x 30 mm
 Minimum distance space: 10 mm

902.875 MHz

Limited modular approval is available. Please contact EnOcean to sign the mandatory limited modular approval user agreement and for MOQ information.
 Design according to drawing below, connect to RF_WHIP.
 Minimum GND plane: 35 mm x 30 mm
 Minimum distance space: 10 mm

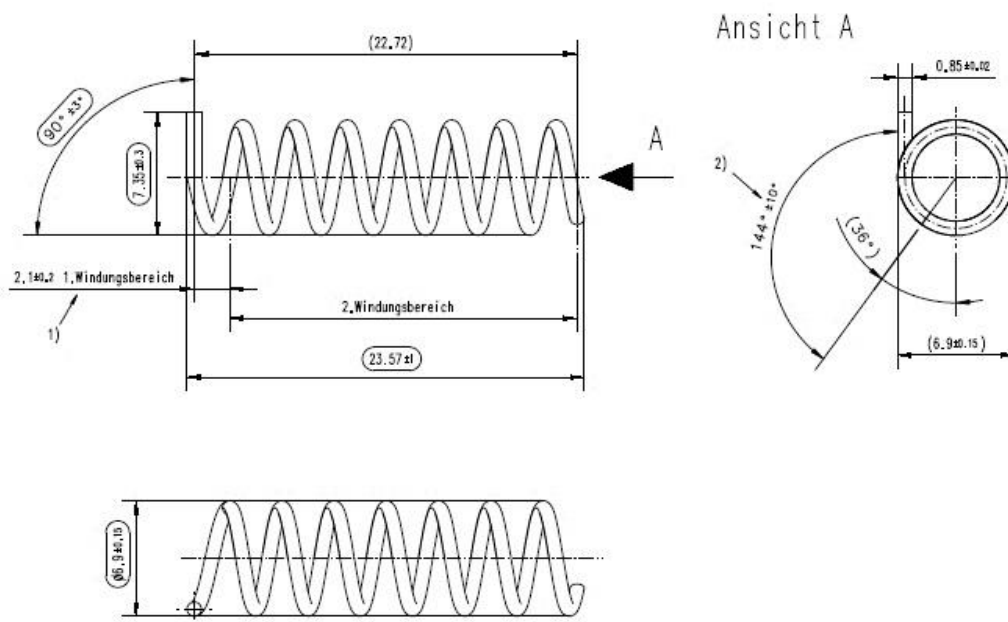

TCM 300 / TCM 300C / TCM 300U
TCM 320 / TCM 320C / TCM 320U

4.2.4 Chip antenna (supplier: Mitsubishi Material, Type AM11DG-ST01)

315 MHz

Modular approval not available. Range and gain significantly reduced because of antenna size vs. the wavelength. Small chip antennas at this frequency may be suited for space-constrained applications. Check with supplier for matching circuit and board design guidelines. Supplier can make recommendations or do testing to optimize individual PCB design.

868.3 MHz

Additional matching circuit and proper board design is required. Check with supplier for matching circuit and board design guidelines. Connect matching circuit to RF_50 using 50 Ohm strip lines. Please follow 902 MHz board design recommendations and dimensions. Be aware that matching values differ!

902.875 MHz

Limited modular approval is available. Please contact EnOcean to sign the mandatory limited modular approval user agreement. Dimensions may not be shortened. Matching circuit is part of the limited modular approval and may not be changed. Minimum top and bottom side ground plane required as shown below. Connect ground planes using multiple via as shown. Connect matching circuit to RF_50. Use High Q wire wound inductors, e.g. 0603 Murata LQW18A series. Matching circuits values: $L1 = 3.9 \text{ nH}$; $L2 = 33 \text{ nH}$, $L3 = 12 \text{ nH}$. This antenna evaluation board is available upon request for use with EnOcean EDK 350 developer kit.

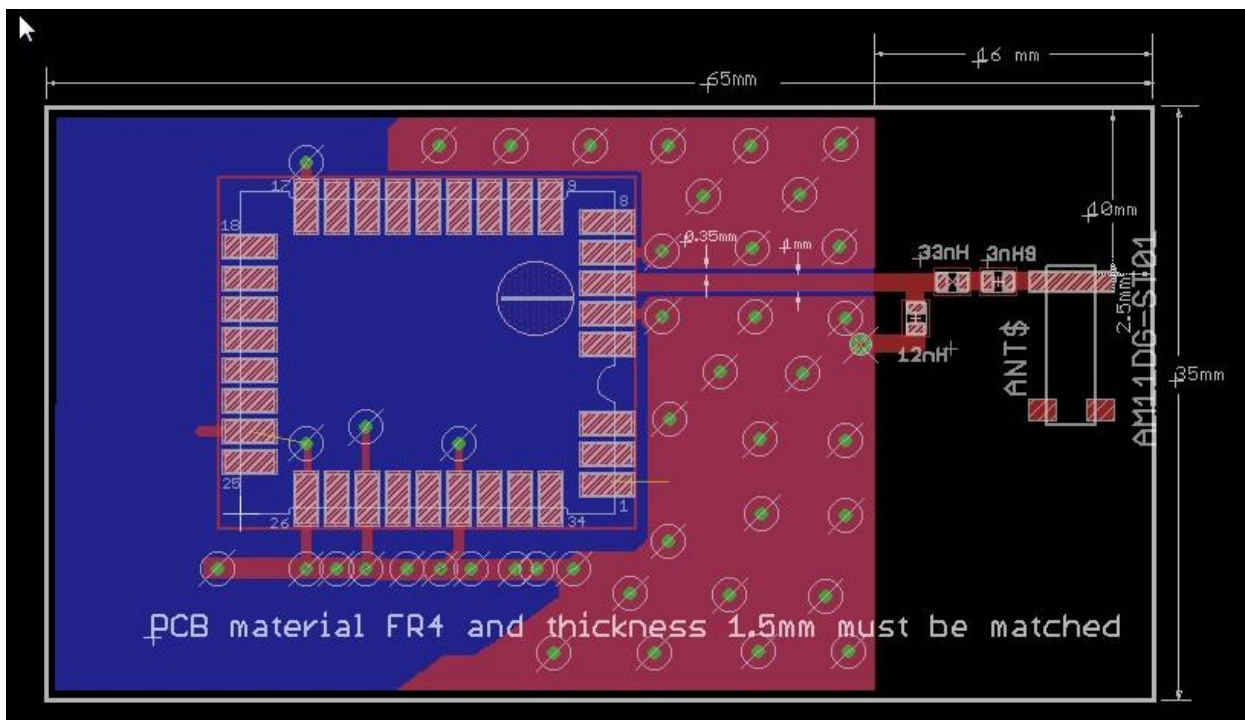

For any further questions or chip antenna quotes, please refer to Mitsubishi Materials website at www.mmea.com or email to electroniccomponents@mmus.com.

TCM 300 / TCM 300C / TCM 300U
 TCM 320 / TCM 320C / TCM 320U

4.3 Antenna options TCM 320x

TCM320x is equipped and approved with a whip antenna.

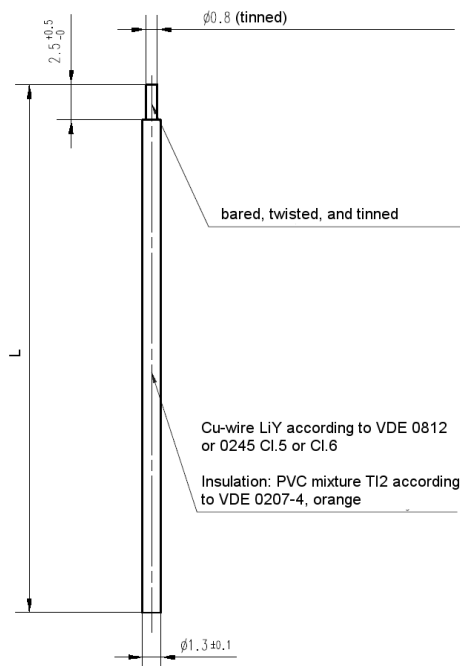

Specification of the TCM whip antenna:

- L=150 mm @ 315 MHz, L=86 mm @ 868.3 MHz, L=64 mm @ 902.875 MHz
- AWG24 wire composed of 7 strands of AWG32 wire
- Material is PVC according to DIN VDE 0207
- Self-extinguishing and flame retardant according to EN 50265-2-1 / IEC 60332-1



Isolation material may break at temperatures below -15 °C.
 Please take care to fix the antenna cable in case vibrations are expected.

4.3.1 Positioning of the whip antenna

Positioning and choice of receiver and transmitter antennas are the most important factors in determining system transmission range.

For good receiver performance, great care must be taken about the space immediately around the antenna since this has a strong influence on screening and detuning the antenna. The antenna should be drawn out as far as possible and must never be cut off. Mainly the far end of the wire should be mounted as far away as possible (at least 15 mm) from all metal parts, ground planes, PCB strip lines and fast logic components (e.g. microprocessors).

Do not roll up or twist the whip antenna!

Radio frequency hash from the motherboard desensitizes the receiver. Therefore:

- PCB strip lines on the user board should be designed as short as possible
- A PCB ground plane layer with sufficient ground vias is strongly recommended
- See also section 4.5 for power supply requirements. Problems may especially occur with switching power supplies!

4.3.2 Mounting 50 Ω antennas

For mounting the receiver at bad RF locations (e.g. within a metal cabinet), an external 50 Ω antenna may be connected. The whip antenna must be removed in this case!

TCM 320 provides soldering pads for an SMA connector, e.g. from Tyco Electronics:

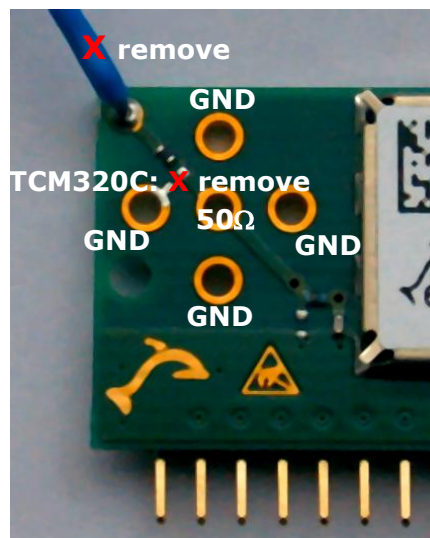

TCM 300 / TCM 300C / TCM 300U
TCM 320 / TCM 320C / TCM 320U

Modification procedure:

- TCM 320: Remove whip antenna and resistor, then mount SMA connector.
- TCM 320C: Remove whip antenna and 12 pF capacitor (see figure above).
Then mount SMA connector
- TCM 320U: Remove whip antenna and resistor, then mount SMA connector.



For 315 MHz and 902 MHz modules (TCM 320C and TCM 320U) please note that a full radio approval needs to be performed if modules are used with external antennas other than the pre-installed whip antenna.



For 868 MHz modules (TCM 320) please note that the external antenna may not exceed 0 dBd antenna gain.



When using the SMA connector pads please make sure no mechanical forces are exerted on the 16-pin connector! It is highly recommended to use a strain relief.

4.4 Recommendations for laying a whip antenna

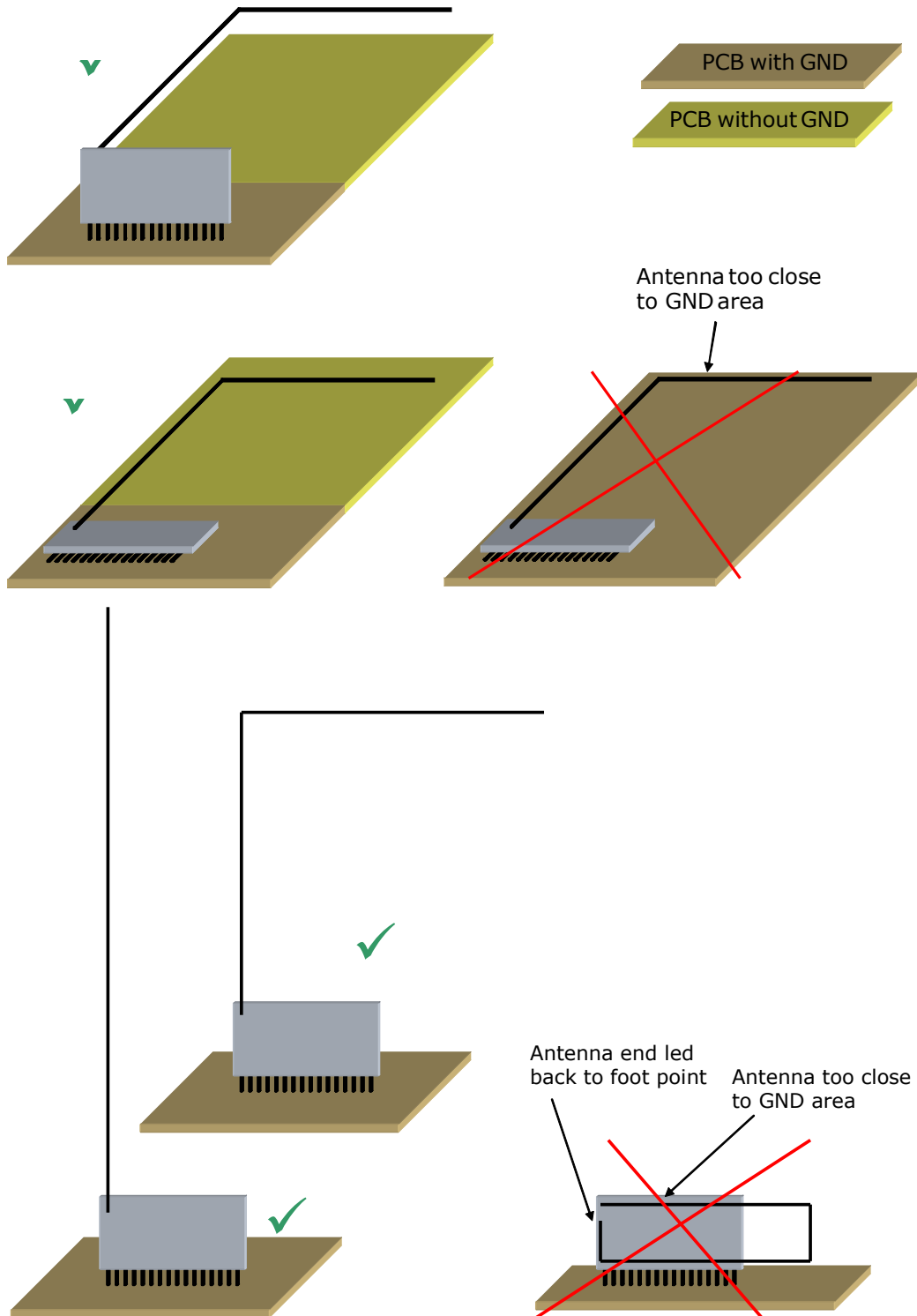

4.5 Power supply requirements

In order to provide a good radio performance, great attention must be paid to the power supply and a correct layout and shielding. It is recommended to place a 22 μ F ceramic capacitor between VDD and GND close to the module (material: X5R, X7R, min 6.3 V to avoid derating effects).

In addition, an HF SMD EMI Suppression Ferrite Bead such as the Würth WE-CBF HF SMD EMI Suppression Ferrite Bead (Würth order number 742863160) shall be inserted in the power supply line.

For best performance it is recommended to keep the ripple on the power supply rail below 10 mVpp (see 3.4).



All GND pins must be connected to GND. Be careful not to create loops! The ground must be realized ideally on both sides of the PCB board with many Vias. At least there must be a short star connection. Otherwise RF performance can be reduced!

4.6 Layout recommendations



The length of lines connected to I/Os should not exceed 5 cm.



It is recommended to have a complete GND layer in the application PCB, at least in the area below the module and directly connected components (e.g. mid-layer of your application PCB).

Due to unisolated test points there are live signals accessible on the bottom side of the module.

Please follow the following advices to prevent interference with your application circuit:

- We suggest avoiding any copper structure in the area directly underneath the module (top-layer layout of your application PCB). If this is not possible in your design, please provide coating on top of your PCB to prevent short circuits to the module. All bare metal surfaces including Vias have to be covered (e.g. adequate layout of solder resist).
- It is mandatory that the area marked by the circle in the figure below is kept clear of any conductive structures in the top layer and 0.3mm below. Otherwise RF performance will be degraded!
- Furthermore, any distortive signals (e.g. bus signals or power lines) should not be routed underneath the module. If such signals are present in your design, we suggest separating them by using a ground plane between module and these signal lines.



The RVDD line should be kept as short as possible. Please consider recommendations in section 4.10.

TCM 300 / TCM 300C / TCM 300U
 TCM 320 / TCM 320C / TCM 320U

4.6.1 TCM 300x recommended foot pattern

Top layer

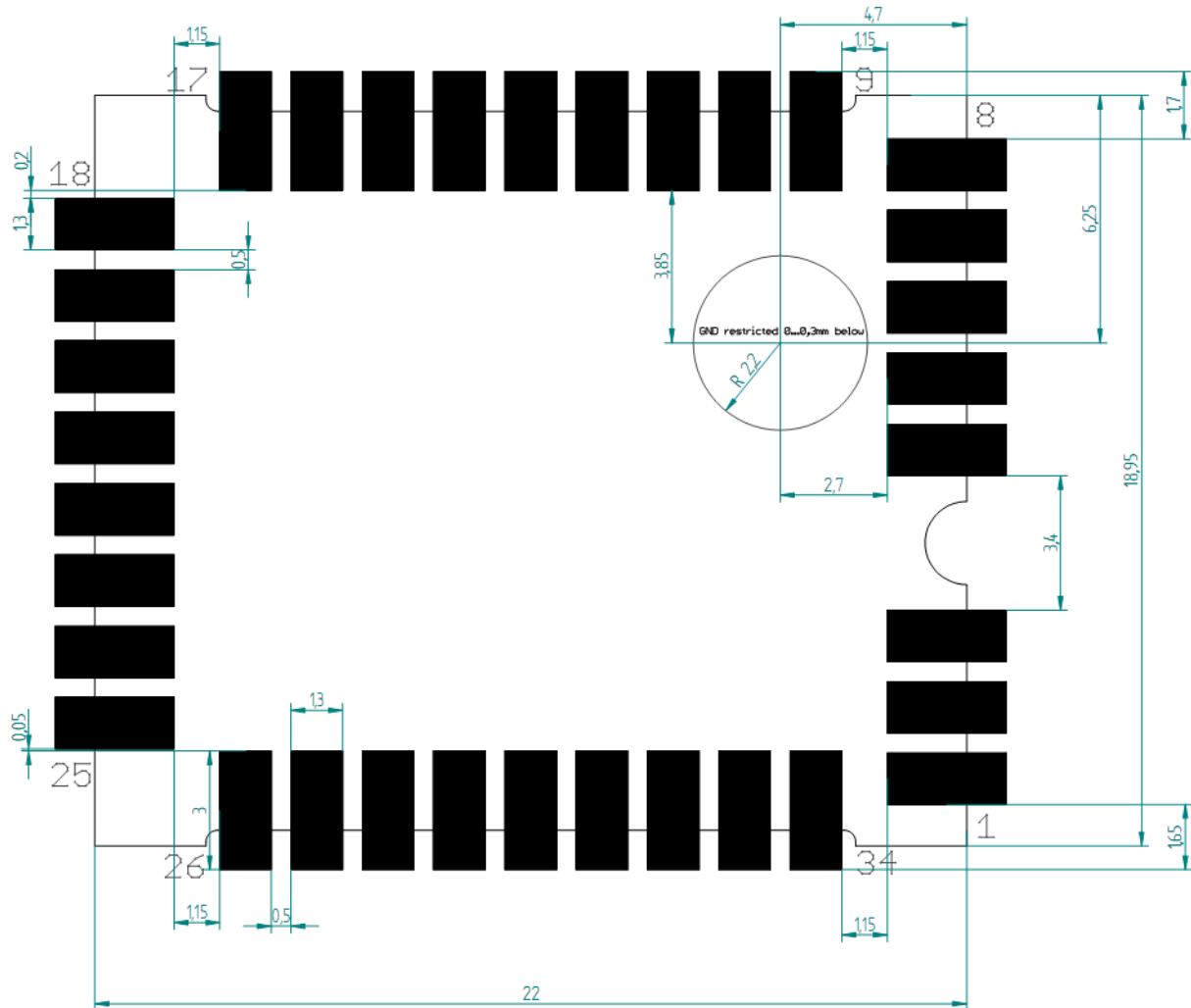

TCM 300 / TCM 300C / TCM 300U
 TCM 320 / TCM 320C / TCM 320U

Solder resist top layer

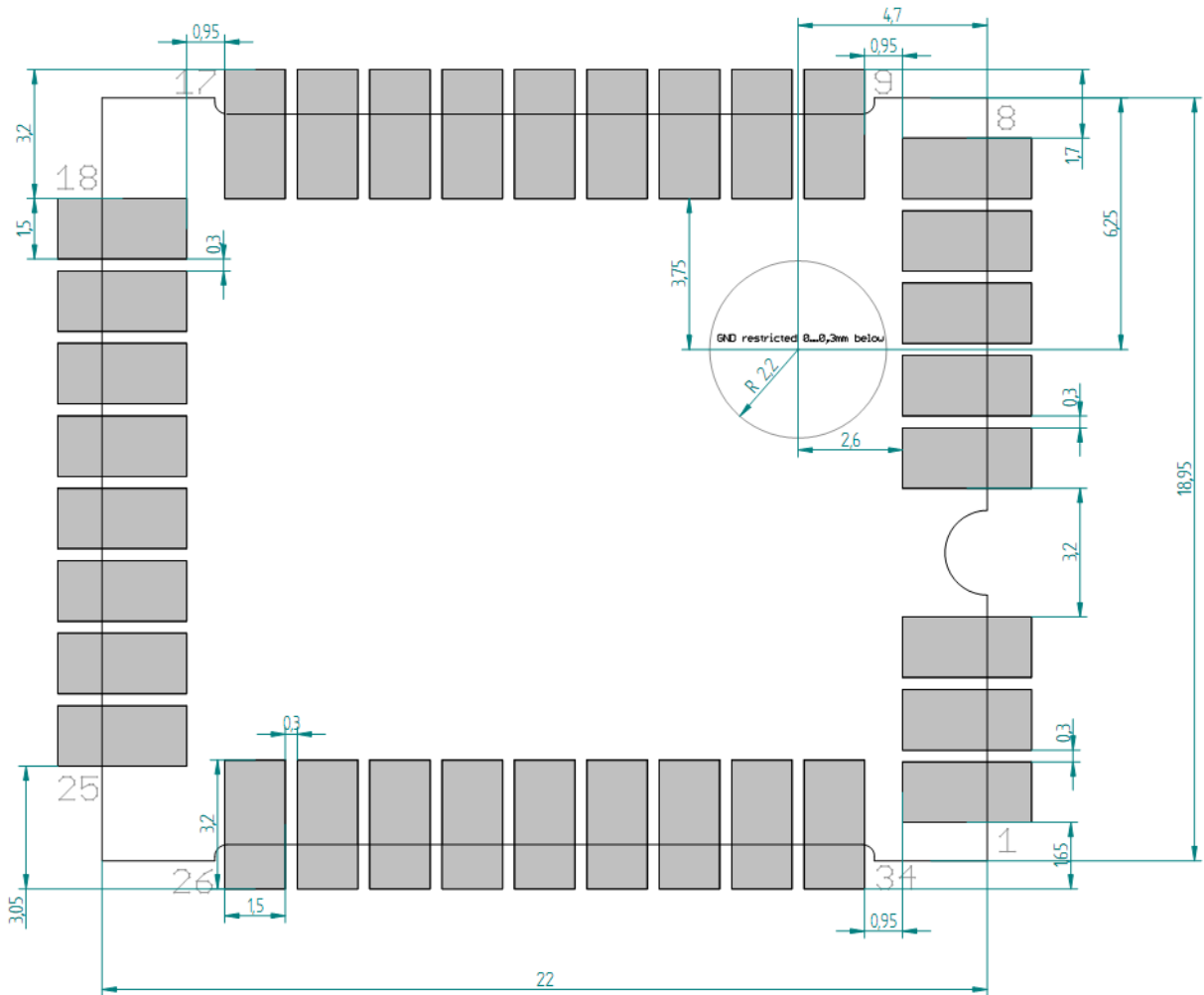

Solder paste top layer

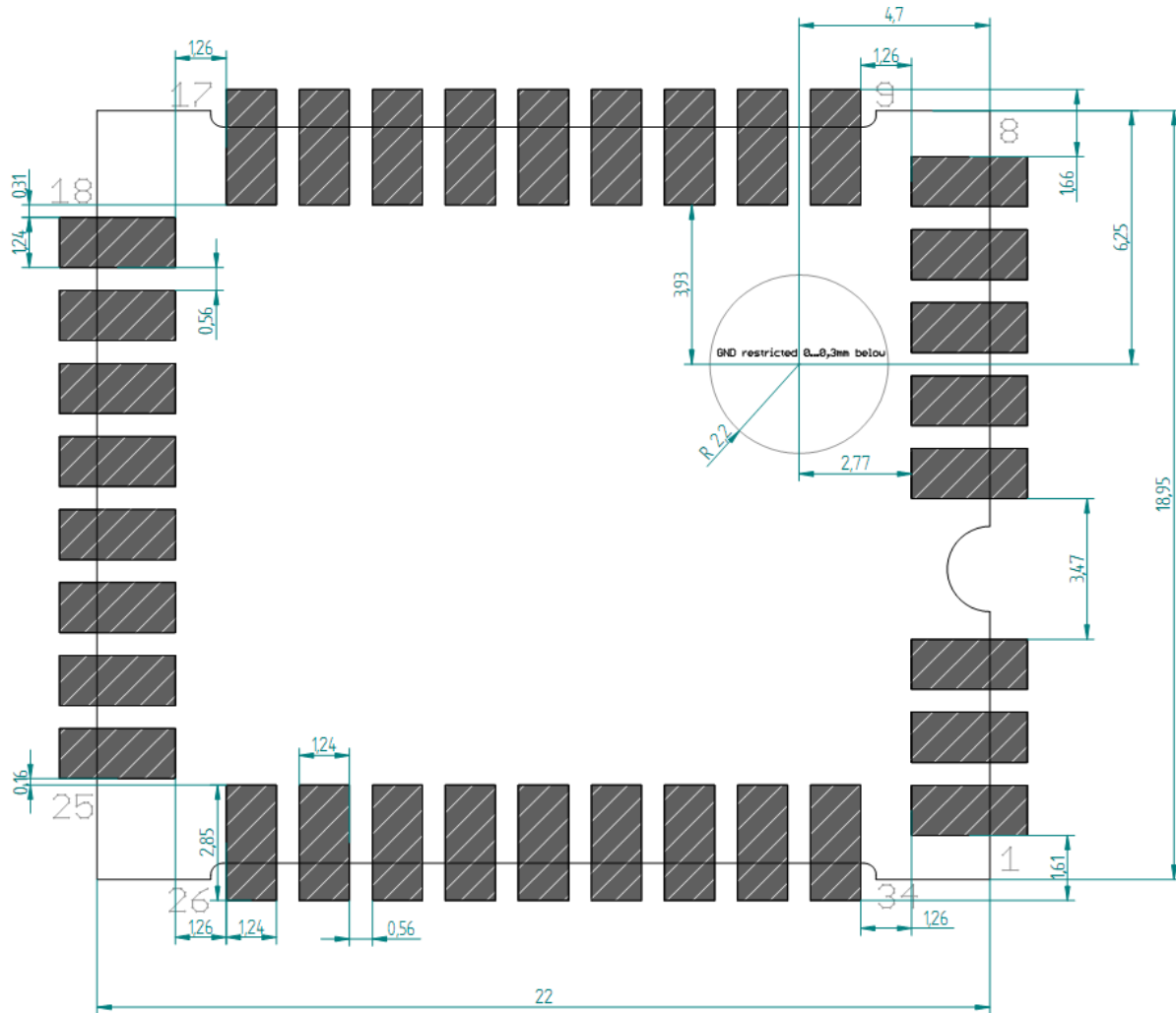

The data above is also available as EAGLE library.

In order to ensure good solder quality a solder mask thickness of 150 µm is recommended.

In case a 120 µm solder mask is used, it is recommended to enlarge the solder print. The pads on the solder print should then be 0.1 mm larger than the pad dimensions of the module as specified in chapter 1). (not relative to the above drawing).

Nevertheless an application and production specific test regarding the amount of soldering paste should be performed to find optimum parameters.

TCM 300 / TCM 300C / TCM 300U
 TCM 320 / TCM 320C / TCM 320U

4.7 Soldering information

4.7.1 TCM 300x

TCM 300x has to be soldered according to IPC/JEDEC J-STD-020C standard.

Profile Feature	Pb-Free Assembly
Average Ramp-Up Rate (TS _{max} to Tp)	3° C/second max.
Preheat	
– Temperature Min (TS _{min})	150 °C
– Temperature Max (TS _{max})	200 °C
– Time (ts _{min} to ts _{max})	60-180 seconds
Time maintained above:	
– Temperature (TL)	217 °C
– Time (tL)	60-150 seconds
Peak/Classification Temperature (Tp)	260 °C
Time within 5 °C of actual Peak Temperature (tp)	20-40 seconds
Ramp-Down Rate	6 °C/second max.
Time 25 °C to Peak Temperature	8 minutes max.

Note 1: All temperatures refer to topside of the package, measured on the package body surface.

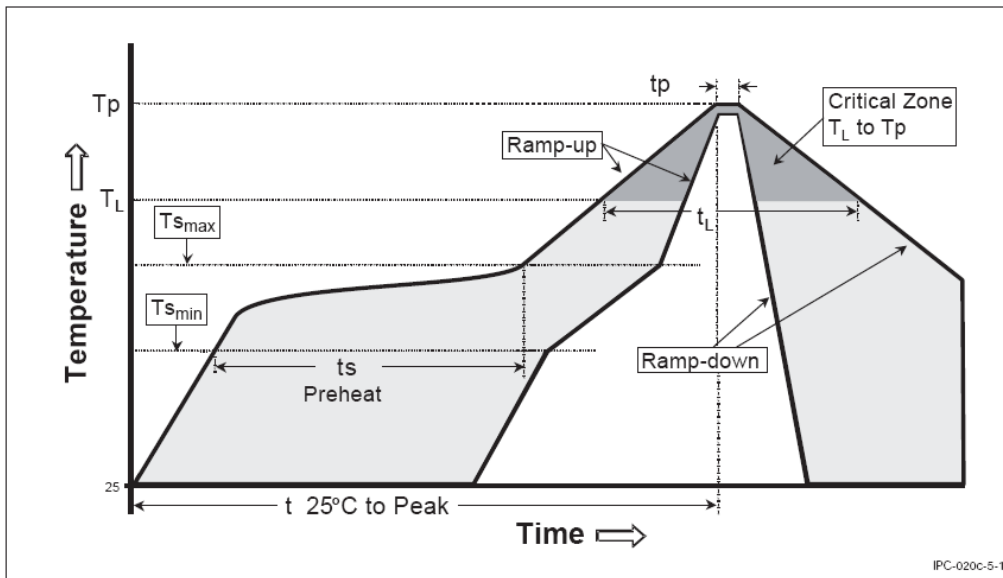

TCM 300x shall be handled according to Moisture Sensitivity Level MSL4 which means a floor time of 72 h. TCM 300 may be soldered only once, since one time is already consumed at production of the module itself.

Once the dry pack bag is opened, the desired quantity of units should be removed and the bag resealed within two hours. If the bag is left open longer than 30 minutes the desiccant should be replaced with dry desiccant. If devices have exceeded the specified floor life time of 72 h, they may be baked according IPC/JEDEC J-STD-033B at max. 90 °C for less than 60 h.

Devices packaged in moisture-proof packaging should be stored in ambient conditions not exceeding temperatures of 40 °C or humidity levels of 90% r.H.

TCM 300x modules have to be soldered within 6 months after delivery!

TCM 300 / TCM 300C / TCM 300U
 TCM 320 / TCM 320C / TCM 320U

4.7.2 TCM 320x



The EO3000I chip inside the module is a moisture sensitive device. In case of wave soldering the modules should be baked in advance.

4.8 Tape & Reel specification TCM 300x

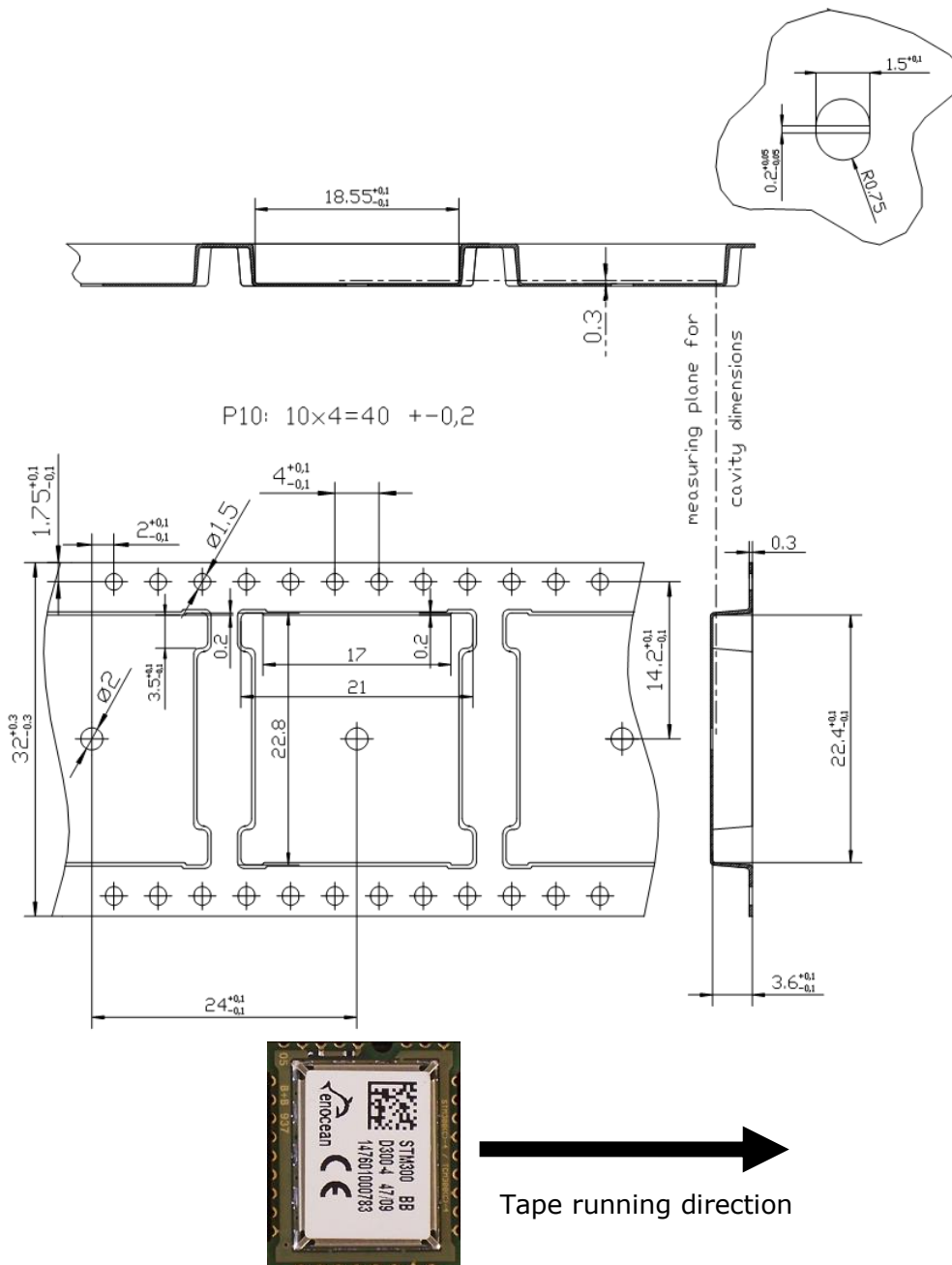

4.9 Backward compatibility to TCM 220C

In Mode 0 TCM 320C is backward compatible to its predecessor TCM 220C. There are a few minor restrictions of compatibility which are listed here:

Parameter	TCM 220C	TCM 320C
Maximum current consumption	34 mA	43 mA
Maximum output current of outputs	25 mA	2 mA (external driver transistor may be needed)
Thickness of module	4.6 mm	5.5 mm
Maximum voltage rating at pin7 (TCM 320C: ADIO6; TCM 220C: IN_5)	6 V	3.6 V
Minimum HIGH voltage level at input pins	1.55 V	2.0 V
Post master function for systems with smart acknowledge	No	Yes, 15 mail boxes
Pull-down 10 kΩ required at Pin 13, 14	No	Yes

4.10 Using RVDD

If RVDD is used in an application circuit a serial ferrite bead shall be used and wire length should be as short as possible (<3 cm). The following ferrite beads have been tested: 74279266 (0603), 74279205 (0805) from Würth. During radio transmission and reception only small currents may be drawn ($I < 100 \mu\text{A}$).

Pulsed current drawn from RVDD has to be avoided. If pulsed currents are necessary, sufficient blocking has to be provided.

4.11 Voltage dips

The module implements mechanisms to deal with temporary supply voltage dips as outlined e.g. by EN60669-2-1.

As soon as the supply voltage drops below the V_{ON}^3 threshold level the current consumption is reduced. TCM 300 will enter short term sleep mode (worst case $35 \mu\text{A}$), TCM 320 will enter standby mode (1.8 mA) for 200 ms.

After exit from this lower power consumption mode, the module will restore the output to its previous state (the state the module output had when the voltage dip occurred) if the supply voltage has returned to a value above the V_{ON} threshold.



If compliance with standards such as EN60669-2-1 is required, the user has to ensure that the system is properly designed and tested for correct operation according to the scenarios described therein. Special care must be taken to guarantee that the required minimum module supply voltage is provided throughout the entire duration of supply voltage dips.

³ For a detailed definition of V_{ON} and V_{OFF} please refer to „Dolphin Core Description“.

5 AGENCY CERTIFICATIONS

The modules have been tested to fulfil the approval requirements for CE (TCM 300 / TCM 320) and FCC/IC (TCM 300C / TCM 300U / TCM 320C / TCM 320U) based on the built-in firmware.



When developing customer specific firmware based on the API for this module, special care must be taken not to exceed the specified regulatory limits, e.g. the duty cycle limitations!

5.1 CE approval

The modules bear the EC conformity marking CE and conform to the R&TTE EU-directive on radio equipment. The assembly conforms to the European and national requirements of electromagnetic compatibility. The conformity has been proven and the according documentation has been deposited at EnOcean. The modules can be operated without notification and free of charge in the area of the European Union, and in Switzerland. The following provisos apply:

- EnOcean RF modules must not be modified or used outside their specification limits.
- EnOcean RF modules may only be used to transfer digital or digitized data. Analog speech and/or music are not permitted.
- The final product incorporating EnOcean RF modules must itself meet the essential requirement of the R&TTE Directive and a CE marking must be affixed on the final product and on the sales packaging each. Operating instructions containing a Declaration of Conformity has to be attached.
- If the transmitter is used according to the regulations of the 868.3 MHz band, a so-called "Duty Cycle" of 1% per hour must not be exceeded. Permanent transmitters such as radio earphones are not allowed.
- The module must be used with only the following approved antenna(s):

Type	Parameter	Value
Wire/Monopole at RF_WHIP	Maximum gain	1.0 dBi
External antenna at RF_50	Antenna type	Passive
	Impedance	~50 Ohm
	Maximum gain	≤ 0 dBd

Duty cycle lock for 868.3 MHz

In order to ensure the 1% duty cycle is not exceeded a watcher is implemented in firmware. This watcher limits the transmission of telegrams beyond the defined 1 % boundary. The EnOcean Duty cycle watcher implementation works as follows: the 60 minute regulatory interval is divided into 10 rolling time slots of equal length. For each of these time

slots, the total transmission time is recorded. In addition to that, the transmission time in the current time slot is recorded. New telegrams will only be transmitted if the total transmission time in the previous 10 time slots (representing a full 60 minute interval), the transmission time in the current time slot and the transmission time of the current telegram combined do not exceed the regulatory limit. The time slots are rotating, freeing always the last slot.

5.2 FCC (United States) Certification

TCM 300C / TCM 320C / TCM 300U / TCM 320U LIMITED MODULAR APPROVAL

This is an RF module approved for Limited Modular use operating as an intentional transmitting device with respect to 47 CFR 15.231(a-c) and is limited to OEM installation. The module is optimized to operate using small amounts of energy, and may be powered by a battery.

The module transmits short radio packets comprised of control signals, (in some cases the control signal may be accompanied with data) such as those used with alarm systems, door openers, remote switches, and the like.

The module does not support continuous streaming of voice, video, or any other forms of streaming data; it sends only short packets containing control signals and possibly data. The module is designed to comply with, has been tested according to 15.231(a-c), and has been found to comply with each requirement.

Thus, a finished device containing the TCM 300C / TCM 320C / TCM 300U / TCM 320U radio module can be operated in the United States without additional Part 15 FCC approval (approval(s) for unintentional radiators may be required for the OEM's finished product), under EnOcean's FCC ID number.

This greatly simplifies and shortens the design cycle and development costs for OEM integrators. The module can be triggered manually or automatically, which cases are described below.

Manual Activation

The radio module can be configured to transmit a short packetized control signal if triggered manually. The module can be triggered, by pressing a switch, for example.

The packet contains one (or more) control signals that is(are) intended to control something at the receiving end. The packet may also contain data. Depending on how much energy is available from the energy source, subsequent manual triggers can initiate the transmission of additional control signals. This may be necessary if prior packet(s) was(were) lost to fading or interference. Subsequent triggers can also be initiated as a precaution if any doubt exists that the first packet didn't arrive at the receiver. Each packet that is transmitted, regardless of whether it was the first one or a subsequent one, will only be transmitted if enough energy is available from the energy source.

Automatic Activation

The radio module also can be configured to transmit a short packetized control signal if triggered automatically, by a relevant change of its inputs or in response to receiving a signal from another transmitter, for example. Again, the packet contains a control signal that is intended to control something at the receiving end and may also contain data. As above, it is possible for the packet to get lost and never reach the receiver. However, if enough energy is available from the energy source, and the module has been configured to do so, then another packet or packets containing the control signal may be transmitted at a later time.

TCM 300 / TCM 300C / TCM 300U
 TCM 320 / TCM 320C / TCM 320U

The device is capable to operate as a repeater, which can receive signals from the following list of FCC/IC approved transmitters, and retransmit the signals.

TCM 3x0C (315 MHz):

■ PTM 200C	FCC ID:SZV-PTM200C	IC:5713A-PTM200C
■ STM 110C	FCC ID:SZV-STM110C	IC:5713A-STM110C
■ TCM 200C	FCC ID:SZV-TCM2XXC	IC:5713A-TCM2XXC
■ TCM 220C	FCC ID:SZV-TCM2XXC	IC:5713A-TCM2XXC
■ TCM 300C	FCC ID:SZV-STM300C	IC:5713A-STM300C
■ TCM 310C	FCC ID:SZV-STM300C	IC:5713A-STM300C
■ STM 300C	FCC ID:SZV-STM300C	IC:5713A-STM300C
■ TCM 320C	FCC ID:SZV-TCM320C	IC:5713A-TCM320C

TCM 300U / TCM 320U:

■ PTM 210U	FCC ID:SZV-PTM210U	IC:5713A-PTM210U
■ PTM 330U	FCC ID:SZV-PTM330U	IC:5713A-PTM330U
■ STM 300U	FCC ID:SZV-STM300U	IC:5713A-STM300U
■ STM 320U	FCC ID:SZV-STM320U	IC:5713A-STM320U
■ STM 332U	FCC ID:SZV-STM332U	IC:5713A-STM332U
■ TCM 300U	FCC ID:SZV-STM300U	IC:5713A-STM300U
■ TCM 310U	FCC ID:SZV-STM300U	IC:5713A-STM300U
■ TCM 320U	FCC ID:SZV-TCM320U	IC:5713A-TCM320U

OEM Requirements

In order to use EnOcean’s FCC ID number, the OEM must ensure that the following conditions are met:

- End users of products, which contain the module, must not have the ability to alter the firmware that governs the operation of the module. The agency grant is valid only when the module is incorporated into a final product by OEM integrators.
- The end-user must not be provided with instructions to remove, adjust or install the module.
- The Original Equipment Manufacturer (OEM) must ensure that FCC labeling requirements are met. This includes a clearly visible label on the outside of the final product. Attaching a label to a removable portion of the final product, such as a battery cover, is not permitted. The label must include the following text:

TCM 300C:

*Contains FCC ID: SZV-STM300C
 The enclosed device complies with Part 15 of the FCC Rules. Operation is subject to the following two conditions: (i.) this device may not cause harmful interference and (ii.) this device must accept any interference received, including interference that may cause undesired operation.*

TCM 320C:

Contains FCC ID: SZV-TCM320C

TCM 300 / TCM 300C / TCM 300U
 TCM 320 / TCM 320C / TCM 320U

The enclosed device complies with Part 15 of the FCC Rules. Operation is subject to the following two conditions: (i.) this device may not cause harmful interference and (ii.) this device must accept any interference received, including interference that may cause undesired operation.

TCM 300U:

Contains FCC ID: SZV-STM300U

The enclosed device complies with Part 15 of the FCC Rules. Operation is subject to the following two conditions: (i.) this device may not cause harmful interference and (ii.) this device must accept any interference received, including interference that may cause undesired operation.

TCM 320U:

Contains FCC ID: SZV-TCM320U

The enclosed device complies with Part 15 of the FCC Rules. Operation is subject to the following two conditions: (i.) this device may not cause harmful interference and (ii.) this device must accept any interference received, including interference that may cause undesired operation.

When the device is so small or for such use that it is not practicable to place the statement above on it, the information required by this paragraph shall be placed in a prominent location in the instruction manual or pamphlet supplied to the user or, alternatively, shall be placed on the container in which the device is marketed. However, the FCC identifier or the unique identifier, as appropriate, must be displayed on the device.

The user manual for the end product must also contain the text given above.

- Changes or modifications not expressly approved by EnOcean could void the user's authority to operate the equipment.
- The module must be used with only the following approved antenna(s):

Part Number	Type	Gain
N.A.	Wire/Monopole	1.0 dBi
ANT 300	Helical (TCM 300U / TCM 320U only)	1.0 dBi
AM11DG-ST01	Chip (TCM 300U / TCM 320U only)	1.0 dBi

- The OEM must ensure that timing requirements according to 47 CFR 15.231(a-c) are met.
- The OEM must sign the OEM Limited Modular Approval Agreement with EnOcean

5.3 IC (Industry Canada) Certification

In order to use EnOcean's IC number, the OEM must ensure that the following conditions are met:

- Labeling requirements for Industry Canada are similar to those required by the FCC. The Original Equipment Manufacturer (OEM) must ensure that IC labeling requirements are met. A clearly visible label on the outside of a non-removable part of the final product must include the following text:

TCM 300C:

Contains IC: 5713A-STM300C

Contient le module d'émission IC: 5713A-STM300C

TCM 320C:

Contains IC: 5713A-TCM320C

Contient le module d'émission IC: 5713A-TCM320C

TCM 300U:

Contains IC: 5713A-STM300U

Contient le module d'émission IC: 5713A-STM300U

TCM 320U:

Contains IC: 5713A-TCM320U

Contient le module d'émission IC: 5713A-TCM320U

- The OEM must sign the OEM Limited Modular Approval Agreement with EnOcean

Pour utiliser le numéro IC EnOcean, le OEM doit s'assurer que les conditions suivantes sont remplies:

- Les exigences d'étiquetage pour Industrie Canada sont similaires à ceux exigés par la FCC. Le fabricant d'équipement d'origine (OEM) doit s'assurer que les exigences en matière d'étiquetage IC sont réunies. Une étiquette clairement visible à l'extérieur d'une partie non amovible du produit final doit contenir le texte suivant:

TCM 300C:

Contains IC: 5713A-STM300C

Contient le module d'émission IC: 5713A-STM300C

TCM 320C:

Contains IC: 5713A-TCM320C

Contient le module d'émission IC: 5713A-TCM320C

TCM 300U:

Contains IC: 5713A-STM300U

Contient le module d'émission IC: 5713A-STM300U

TCM 320U:

Contains IC: 5713A-TCM320U

Contient le module d'émission IC: 5713A-TCM320U

- L'OEM doit signer l'accord OEM limitée Approbation modulaire avec EnOcean

5.4 FCC Regulatory Statements

This device complies with part 15 of the FCC rules. Operation is subject to the following two conditions: (1) This device may not cause harmful interference, and (2) this device must accept any interference received, including interference that may cause undesired operation. Any changes or modifications not expressly approved by manufacturer could void the user's authority to operate the equipment.

IMPORTANT! Any changes or modifications not expressly approved by the party responsible for compliance could void the user's authority to operate this equipment.

NOTE: This equipment has been tested and found to comply with the limits for a Class B digital device, pursuant to part 15 of the FCC Rules. These limits are designed to provide reasonable protection against harmful interference in a residential installation. This equipment generates, uses and can radiate radio frequency energy and, if not installed and used in accordance with the instructions, may cause harmful interference to radio communications.

However, there is no guarantee that interference will not occur in a particular installation. If this equipment does cause harmful interference to radio or television reception, which can be determined by turning the equipment off and on, the user is encouraged to try to correct the interference by one or more of the following measures:

- Reorient or relocate the receiving antenna
- Increase the separation between the equipment and receiver
- Connect the equipment into an outlet on a circuit different from that to which the receiver is connected
- Consult the dealer or an experienced radio/ TV technician for help

5.5 Industry Canada Regulatory Statements

This device complies with Industry Canada licence-exempt RSS standard(s). Operation is subject to the following two conditions: (1) this device may not cause interference, and (2) this device must accept any interference, including interference that may cause undesired operation of the device.

Le présent appareil est conforme aux CNR d'Industrie Canada applicables aux appareils radio exempts de licence. L'exploitation est autorisée aux deux conditions suivantes: (1) l'appareil ne doit pas produire de brouillage, et (2) l'utilisateur de l'appareil doit accepter tout brouillage radioélectrique subi, même si le brouillage est susceptible d'en compromettre le fonctionnement.

IMPORTANT! Tous les changements ou modifications pas expressément approuvés par la partie responsable de la conformité ont pu vider l'autorité de l'utilisateur pour actionner cet équipement.

This Class B digital apparatus complies with Canadian ICES-003.
Cet appareil numérique de la classe B est conforme à la norme NMB-003 du Canada

A Serial Interface

TCM 300 provides operating modes for unidirectional (mode 0) and bidirectional (mode 1) communication. In mode 0 all received radio messages are provided at the serial interface as described in annex A.1. In mode 1 it is also possible to feed telegrams via the serial interface into the module which will subsequently be transmitted. In addition control commands can be sent and control messages can be received. This is described in annex A.2 and A.3.

A.1 EnOcean serial protocol

When the module is in "Serial Interface" mode, it transfers out data blocks of information from the received RF telegrams. As long as no transmitter has been learned, all received EnOcean radio telegrams are transferred. As soon as at least one transmitter has been learned only telegrams of transmitters learned by the receiver are transmitted via the serial interface. Telegrams can be shown on the PC using EnOcean WinEtel or DolphinView software.

A.1.1 Message format (ESP2)

The following figure shows the message format. A block is composed of 2 synchronization bytes, 1 byte for the header and N bytes for the message data.

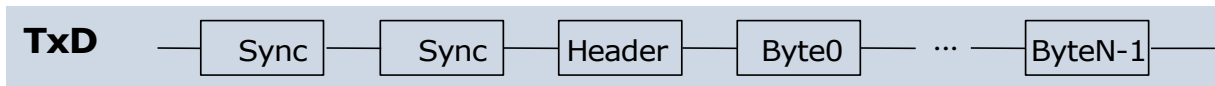

Message format for asynchronous serial communication

A.1.2 Byte signals and bit order

- 9600 bps; 8 data bits, no parity bit, one start bit, one stop bit
- Line idle is binary 1 (standard)
- Each character has one start bit (binary 0), 8 information bits (least significant bit first) and one stop bit (binary 1)

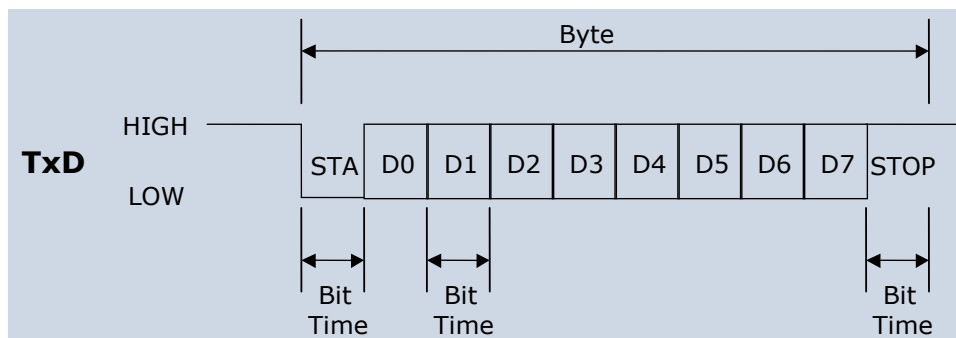

Signals and bit order sending a byte

There are 4 types of ESP2 telegrams:

- RRT - Receive Radio telegrams (from AIR to Serial)
- TRT - Transmit Radio telegrams (from serial to air)
- RCT - Receive Command Telegram (between module and host only serial)
- TCT - Transmit Command Telegram (between module and host only serial)

A.1.3 Description of serial data structure

Bit 7	Bit 0
SYNC_BYTE1 (A5 Hex)	
SYNC_BYTE0 (5A Hex)	
H_SEQ	LENGTH
ORG	
DATA_BYTE3	
DATA_BYTE2	
DATA_BYTE1	
DATA_BYTE0	
ID_BYTE3	
ID_BYTE2	
ID_BYTE1	
ID_BYTE0	
STATUS	
CHECKSUM	

SYNC_BYTE 0..1	(8 bit each)	Synchronization Bytes
H_SEQ	(3 bit)	Header identification (see table below)
LENGTH	(5 bit)	Number of octets following the header octet (11 dec)
ORG	(8 bit)	Type of telegram (see detailed description below)
DATA_BYTE 0..3	(8 bit each)	Data bytes 0..3 (see detailed description below)
ID_BYTE 0..3	(8 bit each)	32-bit transmitter ID ⁴
		For transmission of unique ID enter 0x0000_0000
STATUS	(8 bit)	Status field (see detailed description below)
CHECKSUM	(8 bit)	Checksum (Last LSB from addition of all octets except sync bytes and checksum)

H_SEQ	Meaning	Mode
0b000	<ul style="list-style-type: none"> • Unknown transmitter ID received (serial telegram only if no ID has been learned so far!) • For <i>RPS</i> also: <ul style="list-style-type: none"> ○ Known transmitter ID and unknown rocker ○ U-message from known transmitter ID received • For <i>HRC</i> also: <ul style="list-style-type: none"> ○ Known transmitter ID and unknown rocker ○ Scene switch command (last three bits of ID 0b111) from known transmitter ID (only first 29 bits are compared!) 	Operating Mode
0b001	<ul style="list-style-type: none"> • For 1BS and 4BS: Known transmitter ID received • For RPS: Known transmitter ID and at least 1 known rocker (1 or 2 rockers operated) • For HRC: Known transmitter ID and known rocker 	Operating Mode
0b010	New transmitter learned (If a switch telegram is received (RPS or HRC), the rocker code (RID) is stored together with the ID.)	Learn Mode

⁴ This module allows using a unique ID or one of 128 IDs starting from BaseID. See A.3.1.

0b110	Transmitter just deleted (If a switch telegram is received (RPS or HRC), the rocker code (RID) and module ID are checked. The entry is only deleted if module ID and rocker are known.)	Learn Mode
0b011	Transmit radio Telegram (TRT) Host -> Module -> Air	Operating Mode
0b100	Receive Command Telegram (RCT) Module -> Host	Operating Mode
0b101	Transmit Command Telegram (TCT) Host -> Module	Operating Mode

A.2 Radio transmission/reception commands

The following commands are used to transmit and receive radio telegrams.

Command	Response (RCT)
TX_TELEGRAM (TRT)	OK, ERR, ERR_TX_IDRANGE
RX_TELEGRAM (RRT)	

The TX_TELEGRAM and RX_TELEGRAM telegrams have the same structure. The only difference is in the H_SEQ code, TX_TELEGRAM is identified by "3". RX_Telegrams are identified by the H_SEQ codes according to table in A.1.3.



Before sending commands via the serial interface please always wait for the response to the previous command from the module. The reaction time is below 5ms. Be aware that an already received radio telegram might (concurrently to the command) be sent through the serial port before the command gets processed.

A.2.1 Detailed description of ORG, DATA_BYTE, and STATUS fields

Interoperability of different end-products based on EnOcean technology is an important success factor for establishment of the technology on the market. For this reason EnOcean Alliance pursues standardization of communication profiles, ensuring that sensors from one manufacturer can communicate with receiver gateways of another, for example.

End-users thus have the entire product portfolio - enabled by EnOcean - at their disposal. And product manufacturers can focus on their own special field.

Profiles of existing and upcoming types of equipment are defined in the following download document. Refer back to EnOcean Alliance about adding other profiles.

http://www.enocean-alliance.org/en/enocean_standard/

A.3 Command telegrams and messages



Before sending the next command via serial interface please always wait for the response to the previous command from the module. The reaction time is below 5ms. Be aware that an already received radio telegram might (concurrently to the command) be sent through the serial port before the command gets processed.

A.3.1 ID Range commands

Every TCM 300 supports a unique 32 bit ID and in addition a range of 128 IDs starting at an BaseID address. At production, every TCM 300 is programmed with a unique ID and a BaseID address. The BaseID number can be read via the serial interface. In order to allow a replacement of one unit with another unit (without having to go through the learning procedure with every receiver), the ID range can be changed via the serial interface. The allowed ID range is from 0xFF80_0000 to 0xFFFF_FFFE.

BaseID 32 0

25 most significant bits	0	0	0	0	0	0	0	0
--------------------------	---	---	---	---	---	---	---	---



0xFFFF_FFFF cannot be used. This address is reserved as broadcast ID.

In order to prevent misuse, this feature can only be used 10 times!
Please note: The unique ID cannot be changed.

Command (TCT)	Response (RCT)
SET_BASEID	OK, ERR, ERR_IDRANGE
RD_BASEID	INF_BASEID

A.3.2 Receiver sensitivity commands

The receiver sensitivity can be changed by the following commands. In LOW sensitivity mode, only transmitters in the vicinity of the module are received.

Command (TCT)	Response (RCT)
SET_RX_SENSITIVITY	OK
RD_RX_SENSITIVITY	INF_RX_SENSITIVITY

A.3.3 Reset command

Command (TCT)	Response (RCT)
RESET	

A.3.4 SW Version

Command (TCT)	Response (RCT)
RD_SW_VER	INF_SW_VER

TCM 300 / TCM 300C / TCM 300U
TCM 320 / TCM 320C / TCM 320U

A.3.5 Error messages

Error Messages (RCT)

ERR

ERR_TX_IDRANGE

ERR_IDRANGE

ERR_SYNTAX

A.3.6 Command Encoding

OK

Bit 7	Bit 0
0xA5	
0x5A	
0x8B	
0x58	
X	
X	
X	
X	
X	
X	
X	
X	
X	
X	
ChkSum	

Standard message used to confirm that an action was performed correctly by the TCM.
In case of full duplex communication it may happen that serial telegrams get corrupted and lost. Therefore it is recommended to check for "OK" where applicable.

ERR

Bit 7	Bit 0
0xA5	
0x5A	
0x8B	
0x19	
X	
X	
X	
X	
X	
X	
X	
X	
X	
X	
ChkSum	

Standard error message response if after a TCT command the operation could not be carried out successfully by the TCM.

SET_BASEID

Bit 7	Bit 0
0xA5	
0x5A	
0xAB	
0x18	
BaseIDByte3	
BaseIDByte2	
BaseIDByte1	
BaseIDByte0	
X	
X	
X	
X	
ChkSum	

With this command the user can rewrite its ID range base number. The most significant ID byte is BaseIDByte3. The information of the 25 most significant bits is stored in FLASH. The allowed ID range is from 0xFF80_0000 to 0xFFFF_FFFE.

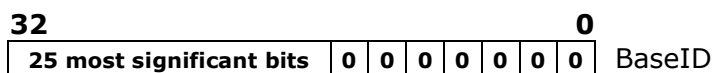

This command can only be used a maximum number of 10 times. After successfully ID range reprogramming, the TCM answers with an OK telegram. If reprogramming was not successful, the TCM answers sending an ERR telegram if the maximum number of 10 times is exceeded or an ERR_IDRANGE telegram if the

BaseID is not within the allowed range.

RD_BASEID

Bit 7 Bit 0

0xA5
0x5A
0xAB
0x58
X
X
X
X
X
X
X
X
X
ChkSum

When this command is sent to the TCM, the base ID range number is retrieved though an INF_BASEID telegram.

INF_BASEID

Bit 7 Bit 0

0xA5
0x5A
0x8B
0x98
BaseIDByte3
BaseIDByte2
BaseIDByte1
BaseIDByte0
X
X
X
X
X
ChkSum

This message informs the user about the ID range base number.

BaseIDByte3 is the most significant byte.

SET_RX_SENSITIVITY

Bit 7 Bit 0

0xA5
0x5A
0xAB
0x08
Sensitivity
X
X
X
X
X
X
X
ChkSum

This command is used to set the TCM radio sensitivity.

In LOW radio sensitivity, signals from remote transmitters are not detected by the TCM receiver. This feature is useful when only information from transmitters in the vicinity should be processed. An OK confirmation telegram is generated after TCM sensitivity has been changed.

Sensitivity=0x00 Low sensitivity
 Sensitivity=0x01 High sensitivity

TCM 300 / TCM 300C / TCM 300U
 TCM 320 / TCM 320C / TCM 320U

RD_RX_SENSITIVITY

Bit 7

Bit 0

0xA5
0x5A
0xAB
0x48
X
X
X
X
X
X
X
X
X
X
ChkSum

This command is sent to the TCM to retrieve the current radio sensitivity mode (HIGH or LOW). This information is sent via a INF_RX_SENSITIVITY command.

INF_RX_SENSITIVITY

Bit 7

Bit 0

0xA5
0x5A
0x8B
0x88
Sensitivity
X
X
X
X
X
X
X
X
ChkSum

This message informs the user about the current TCM radio sensitivity.
 Sensitivity= 0x00 Low sensitivity
 Sensitivity= 0x01 High sensitivity

RESET

Bit 7

Bit 0

0xA5
0x5A
0xAB
0x0A
X
X
X
X
X
X
X
X
X
ChkSum

Performs a reset of the TCM microcontroller.

RD_SW_VER

Bit 7

Bit 0

0xA5
0x5A
0xAB
0x4B
X
X
X
X
X
X
X
X
X
X
ChkSum

This command requests the TCM to send its current software version number.
This information is provided via an INF_SW_VER telegram by the TCM.

INF_SW_VER

Bit 7

Bit 0

0xA5
0x5A
0x8B
0x8C
TCM SW Version Pos.1
TCM SW Version Pos.2
TCM SW Version Pos.3
TCM SW Version Pos.4
API Version Pos.1
API Version Pos.2
API Version Pos.3
API Version Pos.4
X
ChkSum

Informs the user about the current software version of the TCM.
Example: Version 1.0.1.16
TCM SW Version Pos.1 = 1
TCM SW Version Pos.2 = 0
TCM SW Version Pos.3 = 1
TCM SW Version Pos.4 = 16

ERR_SYNTAX

Bit 7

Bit 0

0xA5
0x5A
0x8B
Field
X
X
X
X
X
X
X
X
X
ChkSum

This telegram is sent automatically through the serial port after the TCM has detected a syntax error in a TCT telegram.
Errors can occur in the H_SEQ, LENGTH, ORG or CHKSUM fields/bytes.

Field code:
H_SEQ=0x08 ORG=0x0B
LENGTH=0x09 CHKSUM=0x0A

ERR_TX_IDRANGE

Bit 7 Bit 0

0xA5
0x5A
0x8B
0x22
X
X
X
X
X
X
X
X
X
X
X
ChkSum

When a radio telegram intended to be sent has an ID number outside the ID range, this error message is generated. The radio telegram is not delivered.

ERR_IDRANGE

Bit 7 Bit 0

0xA5
0x5A
0x8B
0x1A
X
X
X
X
X
X
X
X
X
X
ChkSum

This message is generated when the user tries to change the ID range base using the SET_BASEID command to a value outside the allowed range from 0xFF80_0000 to 0xFFFF_FFFE.