

ISL9V5036P3_F085

EcoSPARK® 500mJ, 360V, N-Channel Ignition IGBT

General Description

The ISL9V5036P3_F085 is the next generation IGBT that offer outstanding SCIS capability in the TO-220 plastic package. This device is intended for use in automotive ignition circuit, specifically as coil driver. Internal diode provide voltage clamping without the need for external component.

EcoSPARK® devices can be custom made to specific clamp voltages. Contact your nearest Fairchild sales office for more information.

Formerly Developmental Type 49443

Applications

- Automotive Ignition Coil Driver Circuits
- Coil-On Plug Applications

Features

- Industry Standard TO-220 package
- SCIS Energy = 500mJ at $T_J = 25^\circ\text{C}$
- Logic Level Gate Drive
- Qualified to AEC Q101
- RoHS Compliant



Package

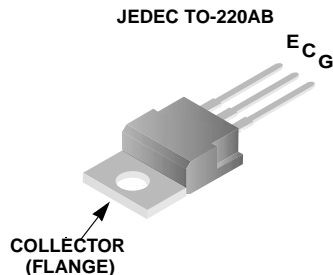

Symbol

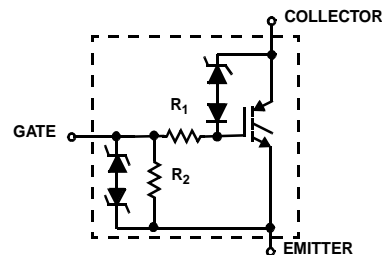

Device Maximum Ratings $T_A = 25^\circ\text{C}$ unless otherwise noted

Symbol	Parameter	Ratings	Units
BV_{CER}	Collector to Emitter Breakdown Voltage ($I_C = 1 \text{ mA}$)	390	V
BV_{ECS}	Emitter to Collector Voltage - Reverse Battery Condition ($I_C = 10 \text{ mA}$)	24	V
E_{SCIS25}	At Starting $T_J = 25^\circ\text{C}$, $I_{SCIS} = 38.5\text{A}$, $L = 670 \mu\text{H}$	500	mJ
$E_{SCIS150}$	At Starting $T_J = 150^\circ\text{C}$, $I_{SCIS} = 30\text{A}$, $L = 670 \mu\text{H}$	300	mJ
I_{C25}	Collector Current Continuous, At $T_C = 25^\circ\text{C}$, See Fig 9	46	A
I_{C110}	Collector Current Continuous, At $T_C = 110^\circ\text{C}$, See Fig 9	31	A
V_{GEM}	Gate to Emitter Voltage Continuous	± 10	V
P_D	Power Dissipation Total $T_C = 25^\circ\text{C}$	250	W
	Power Dissipation Derating $T_C > 25^\circ\text{C}$	1.67	W/ $^\circ\text{C}$
T_J	Operating Junction Temperature Range	-40 to 175	$^\circ\text{C}$
T_{STG}	Storage Junction Temperature Range	-40 to 175	$^\circ\text{C}$
T_L	Max Lead Temp for Soldering (Leads at 1.6mm from Case for 10s)	300	$^\circ\text{C}$
T_{pkg}	Max Lead Temp for Soldering (Package Body for 10s)	260	$^\circ\text{C}$
ESD	Electrostatic Discharge Voltage at 100pF, 1500 Ω	4	kV

Package Marking and Ordering Information

Device Marking	Device	Package	Reel Size	Tape Width	Quantity
V5036P	ISL9V5036P3_F085	TO-220AB	Tube	N/A	50

Electrical Characteristics $T_A = 25^\circ\text{C}$ unless otherwise noted

Symbol	Parameter	Test Conditions	Min	Typ	Max	Units
--------	-----------	-----------------	-----	-----	-----	-------

Off State Characteristics

BV_{CER}	Collector to Emitter Breakdown Voltage	$I_C = 2\text{mA}$, $V_{GE} = 0$, $R_G = 1\text{K}\Omega$, See Fig. 15 $T_J = -40$ to 150°C	330	360	390	V	
BV_{CES}	Collector to Emitter Breakdown Voltage	$I_C = 10\text{mA}$, $V_{GE} = 0$, $R_G = 0$, See Fig. 15 $T_J = -40$ to 150°C	360	390	420	V	
BV_{ECS}	Emitter to Collector Breakdown Voltage	$I_C = -75\text{mA}$, $V_{GE} = 0\text{V}$, $T_C = 25^\circ\text{C}$	30	-	-	V	
BV_{GES}	Gate to Emitter Breakdown Voltage	$I_{GES} = \pm 2\text{mA}$	± 12	± 14	-	V	
I_{CER}	Collector to Emitter Leakage Current	$V_{CER} = 250\text{V}$, $R_G = 1\text{K}\Omega$, See Fig. 11	$T_C = 25^\circ\text{C}$	-	-	25	μA
			$T_C = 150^\circ\text{C}$	-	-	1	mA
I_{ECS}	Emitter to Collector Leakage Current	$V_{EC} = 24\text{V}$, See Fig. 11	$T_C = 25^\circ\text{C}$	-	-	1	mA
			$T_C = 150^\circ\text{C}$	-	-	40	mA
R_1	Series Gate Resistance		-	75	-	Ω	
R_2	Gate to Emitter Resistance		10K	-	30K	Ω	

On State Characteristics

$V_{CE(SAT)}$	Collector to Emitter Saturation Voltage	$I_C = 10\text{A}$, $V_{GE} = 4.0\text{V}$	$T_C = 25^\circ\text{C}$, See Fig. 4	-	1.17	1.60	V
$V_{CE(SAT)}$	Collector to Emitter Saturation Voltage	$I_C = 15\text{A}$, $V_{GE} = 4.5\text{V}$	$T_C = 150^\circ\text{C}$	-	1.50	1.80	V

Dynamic Characteristics

$Q_{G(ON)}$	Gate Charge	$I_C = 10\text{A}$, $V_{CE} = 12\text{V}$, $V_{GE} = 5\text{V}$, See Fig. 14	-	32	-	nC	
$V_{GE(TH)}$	Gate to Emitter Threshold Voltage	$I_C = 1.0\text{mA}$, $V_{CE} = V_{GE}$, See Fig. 10	$T_C = 25^\circ\text{C}$	1.3	-	2.2	V
			$T_C = 150^\circ\text{C}$	0.75	-	1.8	V
V_{GEP}	Gate to Emitter Plateau Voltage	$I_C = 10\text{A}$, $V_{CE} = 12\text{V}$	-	3.0	-	V	

Switching Characteristics

$t_{d(ON)R}$	Current Turn-On Delay Time-Resistive	$V_{CE} = 14\text{V}$, $R_L = 1\Omega$, $V_{GE} = 5\text{V}$, $R_G = 1\text{K}\Omega$, $T_J = 25^\circ\text{C}$, See Fig. 12	-	0.7	4	μs
t_{rR}	Current Rise Time-Resistive		-	2.1	7	μs
$t_{d(OFF)L}$	Current Turn-Off Delay Time-Inductive	$V_{CE} = 300\text{V}$, $L = 2\text{mH}$, $V_{GE} = 5\text{V}$, $R_G = 1\text{K}\Omega$, $T_J = 25^\circ\text{C}$, See Fig. 12	-	10.8	15	μs
t_{fL}	Current Fall Time-Inductive		-	2.8	15	μs
SCIS	Self Clamped Inductive Switching	$T_J = 25^\circ\text{C}$, $L = 670\mu\text{H}$, $R_G = 1\text{K}\Omega$, $V_{GE} = 5\text{V}$, See Fig. 1 & 2	-	-	500	mJ

Thermal Characteristics

$R_{\theta JC}$	Thermal Resistance Junction-Case	-	-	0.6	$^\circ\text{C/W}$
-----------------	----------------------------------	---	---	-----	--------------------

Typical Characteristics

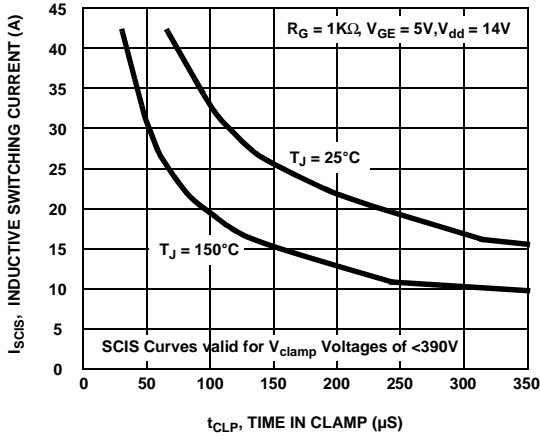

Figure 1. Self Clamped Inductive Switching Current vs Time in Clamp

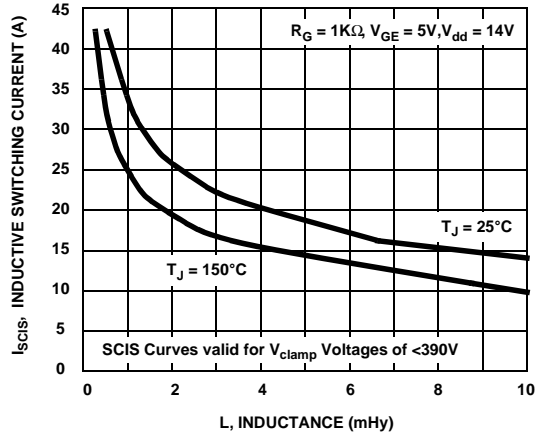

Figure 2. Self Clamped Inductive Switching Current vs Inductance

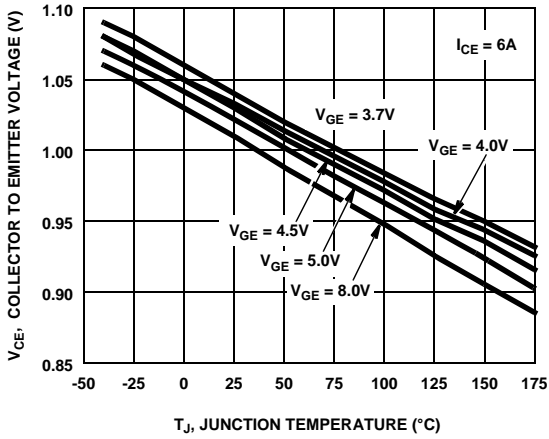

Figure 3. Collector to Emitter On-State Voltage vs Junction Temperature

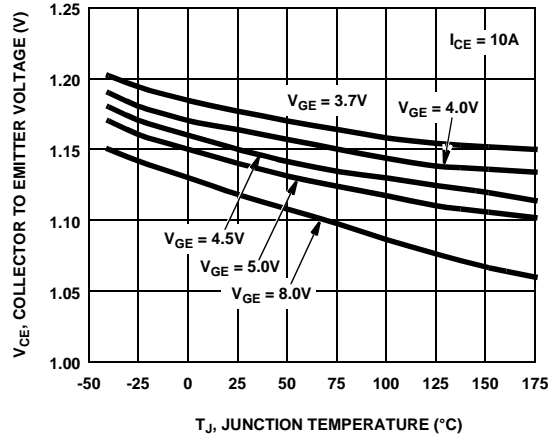

Figure 4. Collector to Emitter On-State Voltage vs Junction Temperature

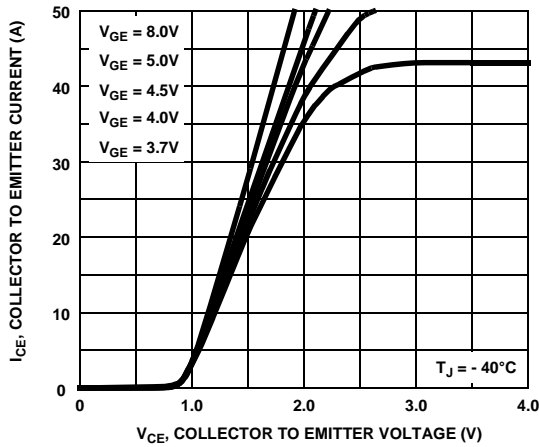

Figure 5. Collector Current vs Collector to Emitter On-State Voltage

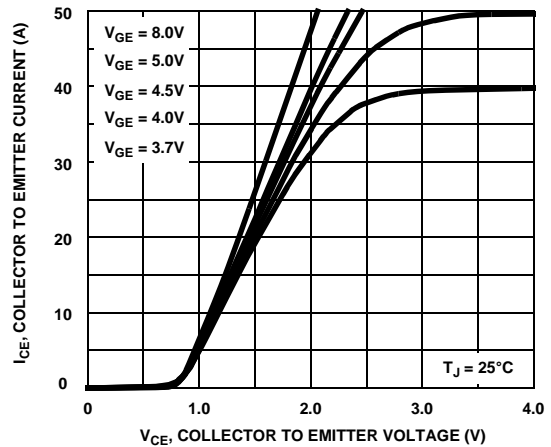

Figure 6. Collector Current vs Collector to Emitter On-State Voltage

Typical Characteristics (Continued)

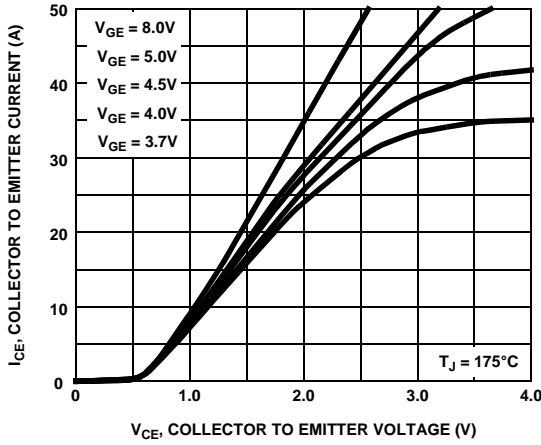

Figure 7. Collector to Emitter On-State Voltage vs Collector Current

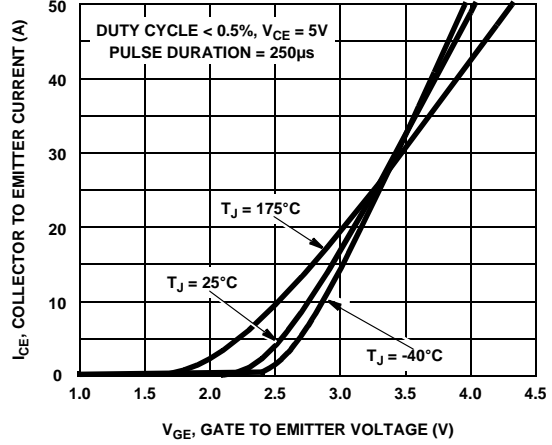

Figure 8. Transfer Characteristics

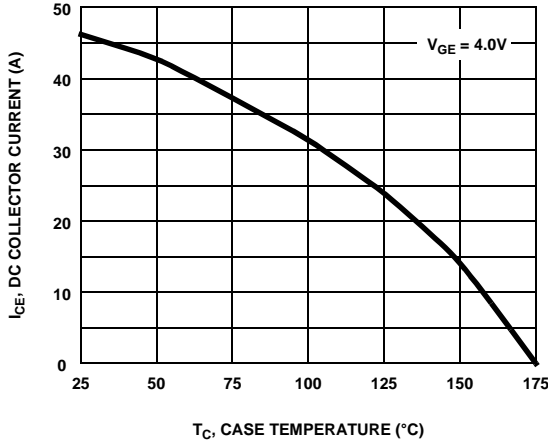

Figure 9. DC Collector Current vs Case Temperature

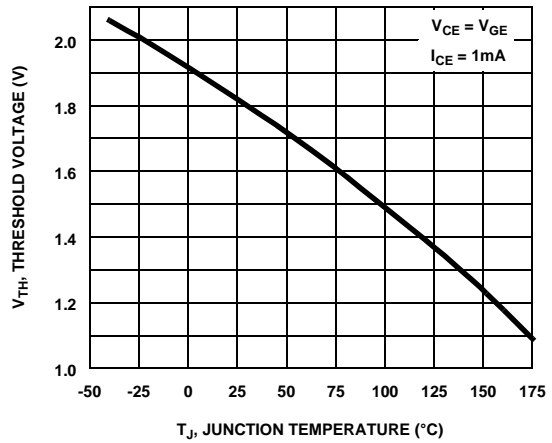

Figure 10. Threshold Voltage vs Junction Temperature

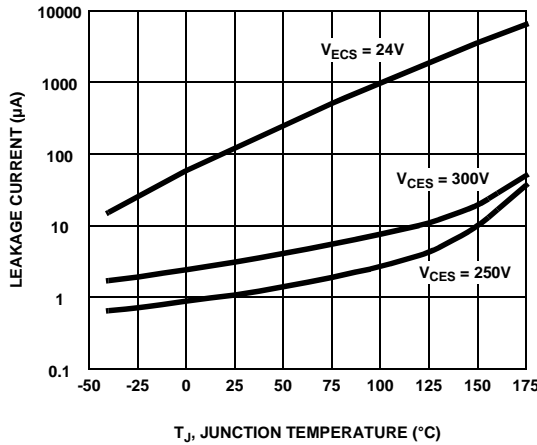

Figure 11. Leakage Current vs Junction Temperature

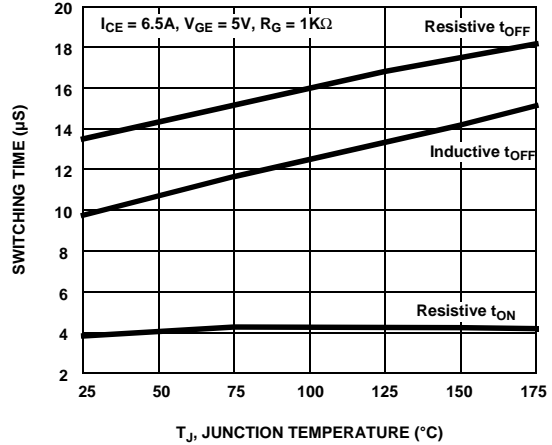

Figure 12. Switching Time vs Junction Temperature

Typical Characteristics (Continued)

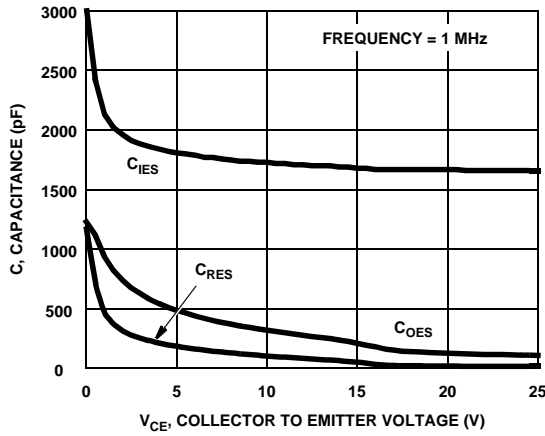

Figure 13. Capacitance vs Collector to Emitter Voltage

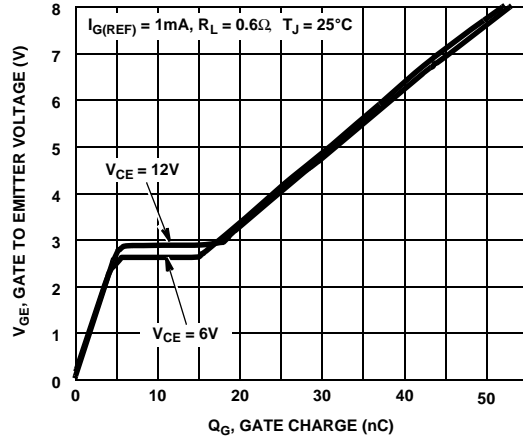

Figure 14. Gate Charge

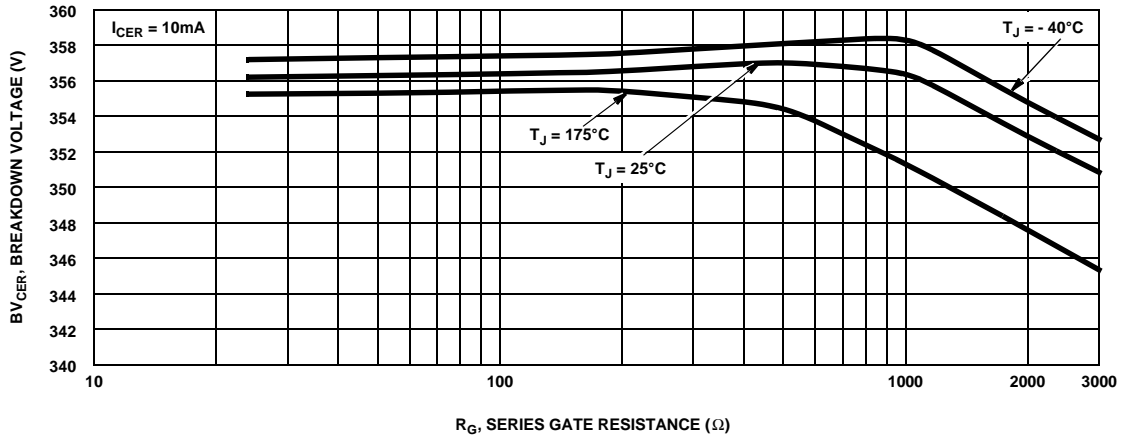

Figure 15. Breakdown Voltage vs Series Gate Resistance

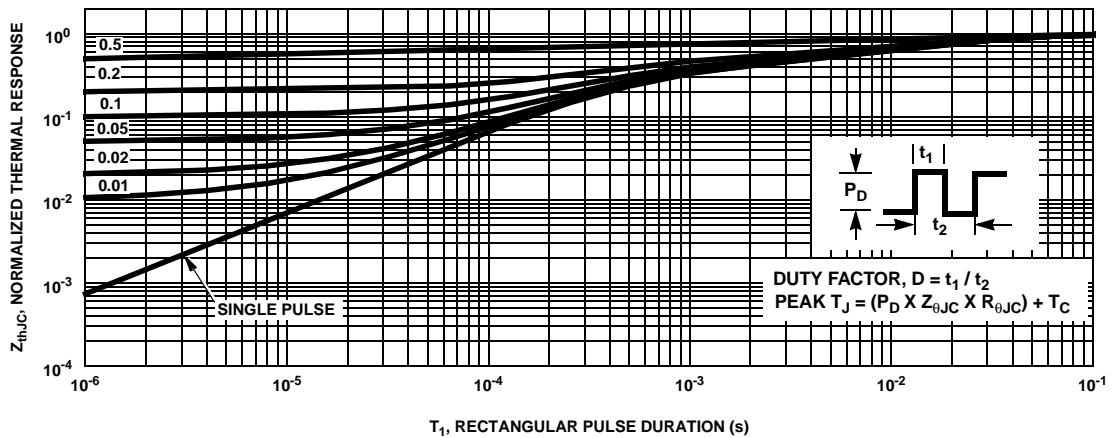

Figure 16. IGBT Normalized Transient Thermal Impedance, Junction to Case

Test Circuits and Waveforms

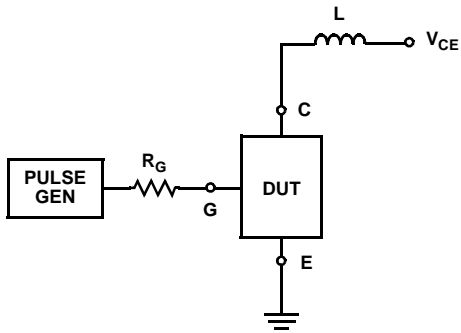

Figure 17. Inductive Switching Test Circuit

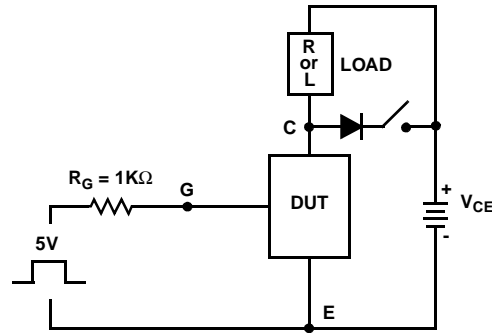

Figure 18. t_{ON} and t_{OFF} Switching Test Circuit

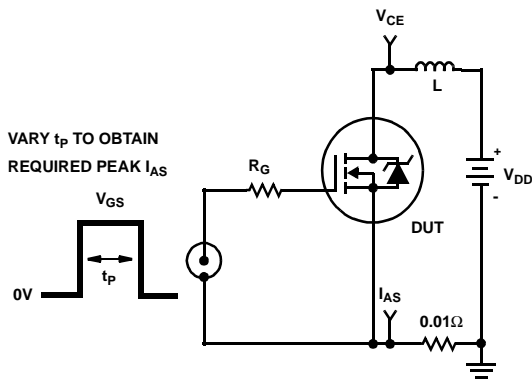

Figure 19. Energy Test Circuit

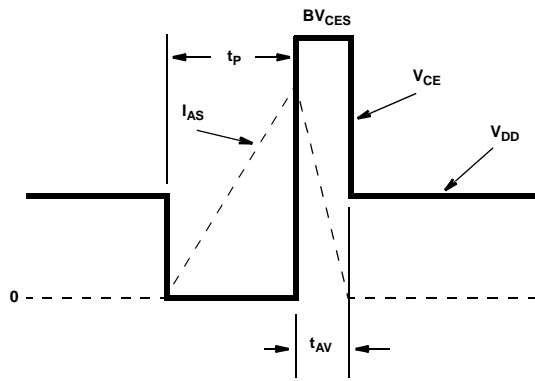

Figure 20. Energy Waveforms



TRADEMARKS

The following includes registered and unregistered trademarks and service marks, owned by Fairchild Semiconductor and/or its global subsidiaries, and is not intended to be an exhaustive list of all such trademarks.

2Cool™	FlashWriter® *	PDP SPM™	The Power Franchise®
AccuPower™	FPS™	Power-SPM™	The Right Technology for Your Success™
Auto-SPM™	F-PFS™	PowerTrench®	
AX-CAP™*	FRFET®	PowerXS™	power
BitSiC®	Global Power ResourceSM	Programmable Active Droop™	the franchise
Build it Now™	Green FPS™	QFET®	TinyBoost™
CorePLUS™	Green FPS™ e-Series™	QS™	TinyBuck™
CorePOWER™	Gmax™	Quiet Series™	TinyCalc™
CROSSVOLT™	GTO™	RapidConfigure™	TinyLogic®
CTL™	IntelliMAX™	 ™	TINYOPTO™
Current Transfer Logic™	ISOPLANAR™	Saving our world, 1mW/W/kW at a time™	TinyPower™
DEUXPEED®	MegaBuck™	SignalWise™	TinyPWM™
Dual Cool™	MICROCOUPLER™	SmartMax™	TinyWire™
EcoSPARK®	MicroFET™	SMART START™	TranSiC®
EfficientMax™	MicroPak™	SPM®	TriFault Detect™
ESBC™	MicroPak2™	STEALTH™	TRUECURRENT®*
 ™	MillerDrive™	SuperFET®	μSerDes™
Fairchild®	MotionMax™	SuperSOT™-3	 ™
Fairchild Semiconductor®	Motion-SPM™	SuperSOT™-6	UHC®
FACT Quiet Series™	mWSaver™	SuperSOT™-8	Ultra FRFET™
FACT®	OptiHiT™	SupreMOS®	UniFET™
FAST®	OPTOLOGIC®	SyncFET™	VCX™
FastvCore™	OPTOPLANAR®	Sync-Lock™	VisualMax™
FETBench™		 ™	XS™

*Trademarks of System General Corporation, used under license by Fairchild Semiconductor.

DISCLAIMER

FAIRCHILD SEMICONDUCTOR RESERVES THE RIGHT TO MAKE CHANGES WITHOUT FURTHER NOTICE TO ANY PRODUCTS HEREIN TO IMPROVE RELIABILITY, FUNCTION, OR DESIGN. FAIRCHILD DOES NOT ASSUME ANY LIABILITY ARISING OUT OF THE APPLICATION OR USE OF ANY PRODUCT OR CIRCUIT DESCRIBED HEREIN; NEITHER DOES IT CONVEY ANY LICENSE UNDER ITS PATENT RIGHTS, NOR THE RIGHTS OF OTHERS. THESE SPECIFICATIONS DO NOT EXPAND THE TERMS OF FAIRCHILD'S WORLDWIDE TERMS AND CONDITIONS, SPECIFICALLY THE WARRANTY THEREIN, WHICH COVERS THESE PRODUCTS.

LIFE SUPPORT POLICY

FAIRCHILD'S PRODUCTS ARE NOT AUTHORIZED FOR USE AS CRITICAL COMPONENTS IN LIFE SUPPORT DEVICES OR SYSTEMS WITHOUT THE EXPRESS WRITTEN APPROVAL OF FAIRCHILD SEMICONDUCTOR CORPORATION.

As used here in:

1. Life support devices or systems are devices or systems which, (a) are intended for surgical implant into the body or (b) support or sustain life, and (c) whose failure to perform when properly used in accordance with instructions for use provided in the labeling, can be reasonably expected to result in a significant injury of the user.
2. A critical component in any component of a life support, device, or system whose failure to perform can be reasonably expected to cause the failure of the life support device or system, or to affect its safety or effectiveness.

ANTI-COUNTERFEITING POLICY

Fairchild Semiconductor Corporation's Anti-Counterfeiting Policy. Fairchild's Anti-Counterfeiting Policy is also stated on our external website, www.Fairchildsemi.com, under Sales Support.

Counterfeiting of semiconductor parts is a growing problem in the industry. All manufacturers of semiconductor products are experiencing counterfeiting of their parts. Customers who inadvertently purchase counterfeit parts experience many problems such as loss of brand reputation, substandard performance, failed application, and increased cost of production and manufacturing delays. Fairchild is taking strong measures to protect ourselves and our customers from the proliferation of counterfeit parts. Fairchild strongly encourages customers to purchase Fairchild parts either directly from Fairchild or from Authorized Fairchild Distributors who are listed by country on our web page cited above. Products customers buy either from Fairchild directly or from Authorized Fairchild Distributors are genuine parts, have full traceability, meet Fairchild's quality standards for handling and storage and provide access to Fairchild's full range of up-to-date technical and product information. Fairchild and our Authorized Distributors will stand behind all warranties and will appropriately address and warranty issues that may arise. Fairchild will not provide any warranty coverage or other assistance for parts bought from Unauthorized Sources. Fairchild is committed to combat this global problem and encourage our customers to do their part in stopping this practice by buying direct or from authorized distributors.

PRODUCT STATUS DEFINITIONS

Definition of Terms

Datasheet Identification	Product Status	Definition
Advance Information	Formative / In Design	Datasheet contains the design specifications for product development. Specifications may change in any manner without notice.
Preliminary	First Production	Datasheet contains preliminary data; supplementary data will be published at a later date. Fairchild Semiconductor reserves the right to make changes at any time without notice to improve design.
No Identification Needed	Full Production	Datasheet contains final specifications. Fairchild Semiconductor reserves the right to make changes at any time without notice to improve the design.
Obsolete	Not In Production	Datasheet contains specifications on a product that is discontinued by Fairchild Semiconductor. The datasheet is for reference information only.