

4-line bidirectional Transil™, transient surge voltage suppressor for ESD protection

Datasheet – production data

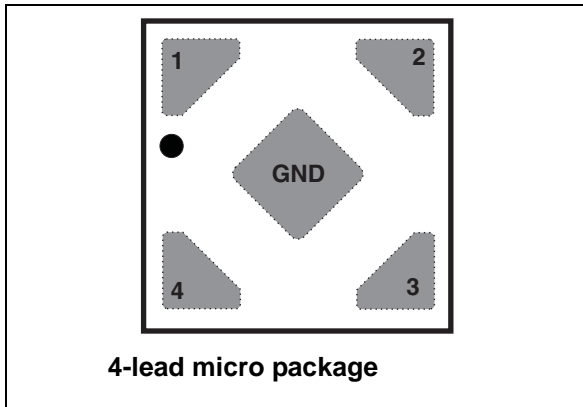
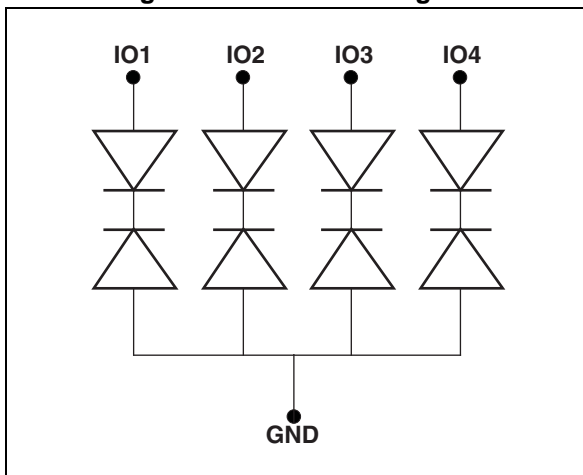

Figure 1. Functional diagram



Features

- 4 bidirectional Transil diodes
- Breakdown voltage $V_{BR} = 5.5 \text{ V min.}$
- Low leakage current: $< 50 \text{ nA}$
- Very small PCB area: 0.64 mm^2
- Lead-free and RoHS compliant

Complies with the following standards

- IEC 61000-4-2 level 4:
 - $\pm 15 \text{ kV}$ (air discharge)
 - $\pm 8 \text{ kV}$ (contact discharge)

Applications

Where transient over voltage protection in ESD sensitive equipment is required, such as:

- Mobile phones
- Portable multimedia devices and accessories
- Computers, tablets and peripherals
- Set top boxes
- Audio equipment

Description

The ESDAVLC5-4BX4 is monolithic array designed to protect up to 4 bidirectional lines against ESD transients.

The device is ideal for applications where both reduced printed circuit board space and high ESD protection level are required.

TM: Transil is a trademark of STMicroelectronics

1 Characteristics

Table 1. Absolute maximum ratings ($T_{amb} = 25\text{ }^{\circ}\text{C}$)

Symbol	Parameter		Value	Unit
$V_{PP}^{(1)}$	Peak pulse voltage	IEC 61000-4-2 contact discharge	16	kV
		IEC 61000-4-2 air discharge	16	
I_{PP}	Peak pulse current (8/20 μs)		2	A
P_{PP}	Peak pulse power (8/20 μs)		30	W
T_j	Operating temperature range		-30 to +85	$^{\circ}\text{C}$
T_{stg}	Storage temperature range		- 55 to +150	$^{\circ}\text{C}$
T_L	Maximum lead temperature for soldering during 10 s		260	$^{\circ}\text{C}$

1. For a surge greater than the maximum values, the diode will fail in short-circuit.

Figure 2. Electrical characteristics (definitions)

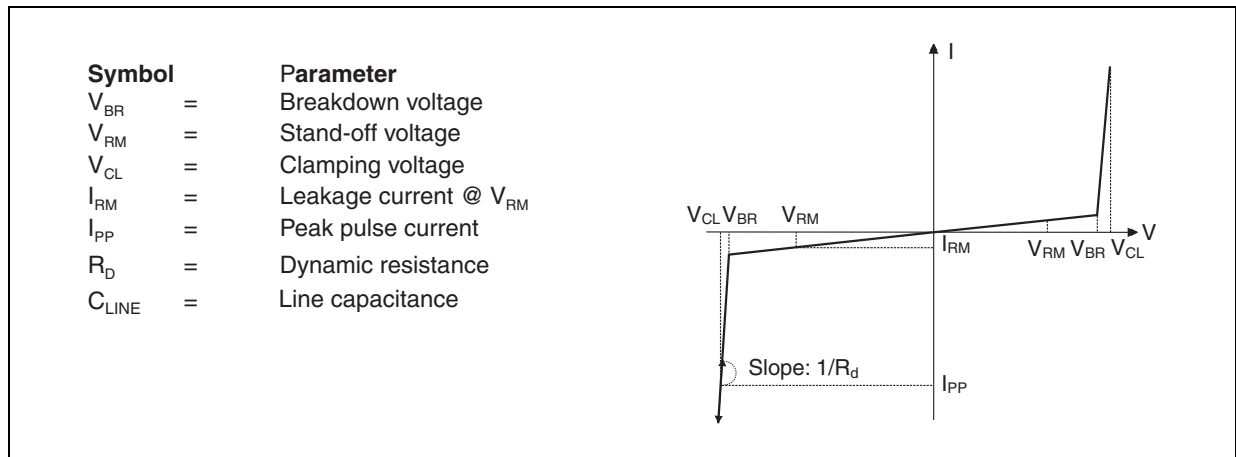

Table 2. Electrical characteristics (values, $T_{amb} = 25\text{ }^{\circ}\text{C}$)

Symbol	Parameter	Test conditions	Value			Unit
			Min.	Typ.	Max.	
V_{BR}	Breakdown voltage	$I_R = 1\text{ mA}$	5.5			V
I_{RM}	Leakage current	$V_{RM} = 3\text{ V}$			50	nA
V_{CL}	Clamping voltage	$I_{PP} = 1\text{ A}, 8/20\ \mu\text{s}$			18	V
C_{line}	Line capacitance, I/O to GND	$V_R = 0\text{ V}, F_{osc} = 1\text{ MHz}, V_{osc} = 30\text{ mV}$			10	pF
R_d	Dynamic resistance, pulse width 100 ns	I/O to GND		0.53		Ω
		GND to I/O		0.37		

Figure 3. Leakage current versus junction temperature (typical values)

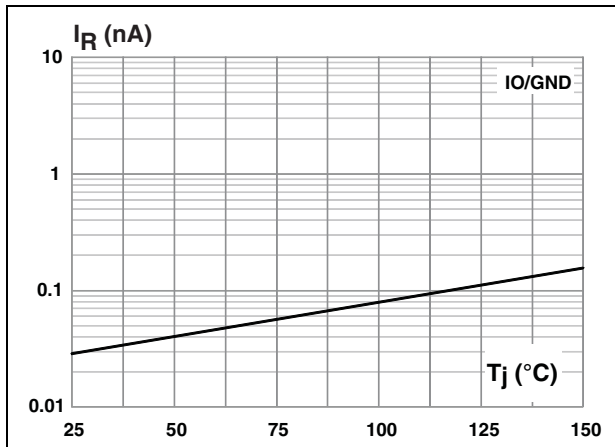

Figure 4. Junction capacitance versus reverse applied voltage (typical values)

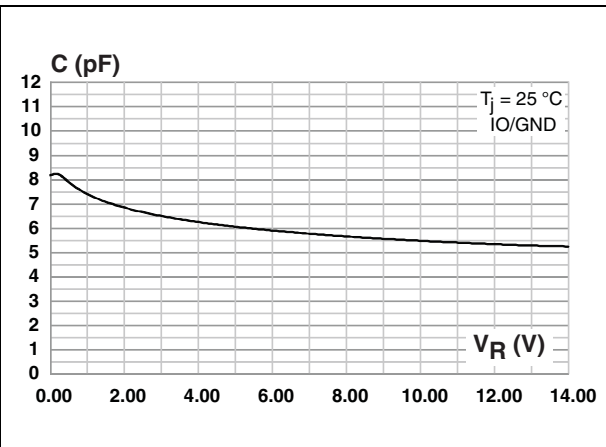

Figure 5. ESD response to IEC 61000-4-2 (typical values, +8 kV contact discharge)

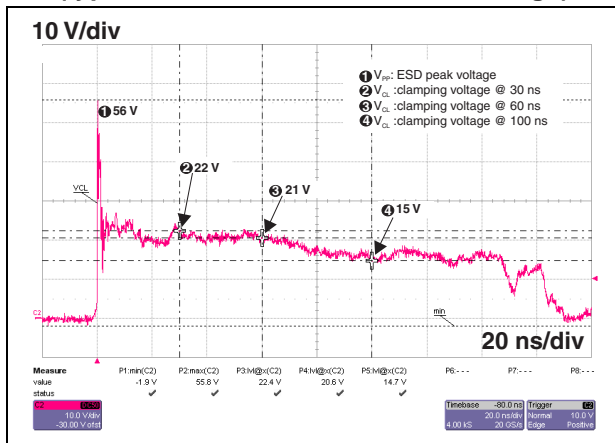

Figure 6. ESD response to IEC 61000-4-2 (typical values, -8 kV contact discharge)

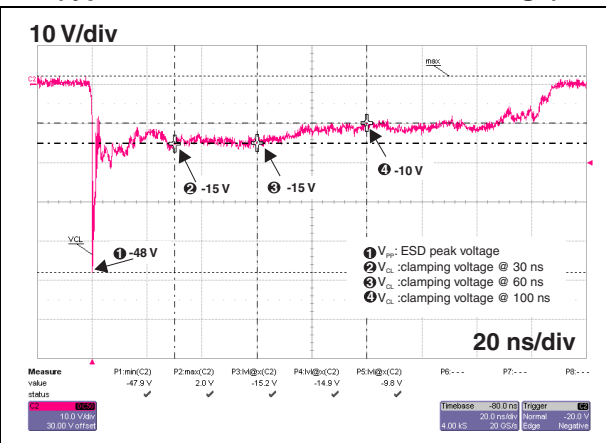

Figure 7. S21 attenuation measurement

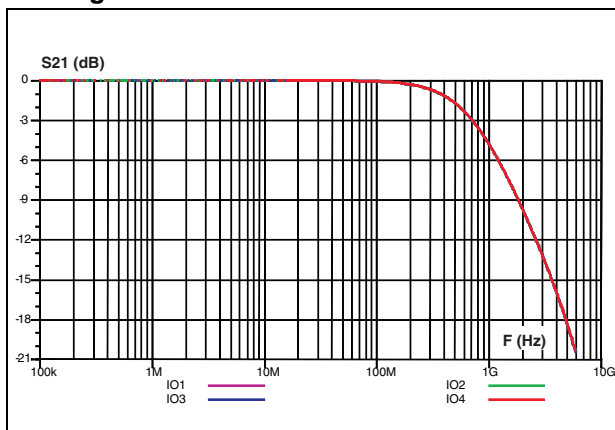
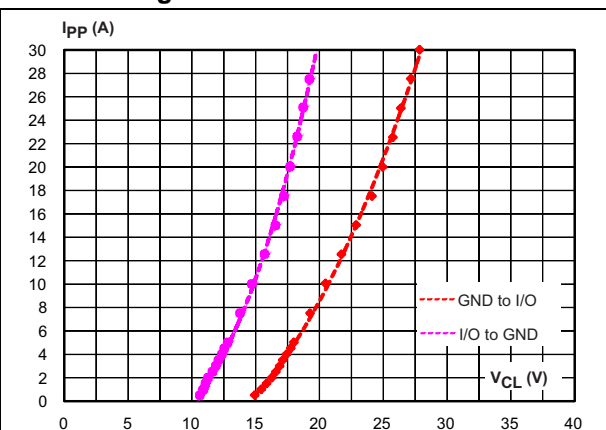

Figure 8. TLP measurement



2 Package information

- Epoxy meets UL94, V0
- Lead-free package

In order to meet environmental requirements, ST offers these devices in different grades of ECOPACK® packages, depending on their level of environmental compliance. ECOPACK® specifications, grade definitions and product status are available at: www.st.com. ECOPACK® is an ST trademark.

Figure 9. Micro package dimensions

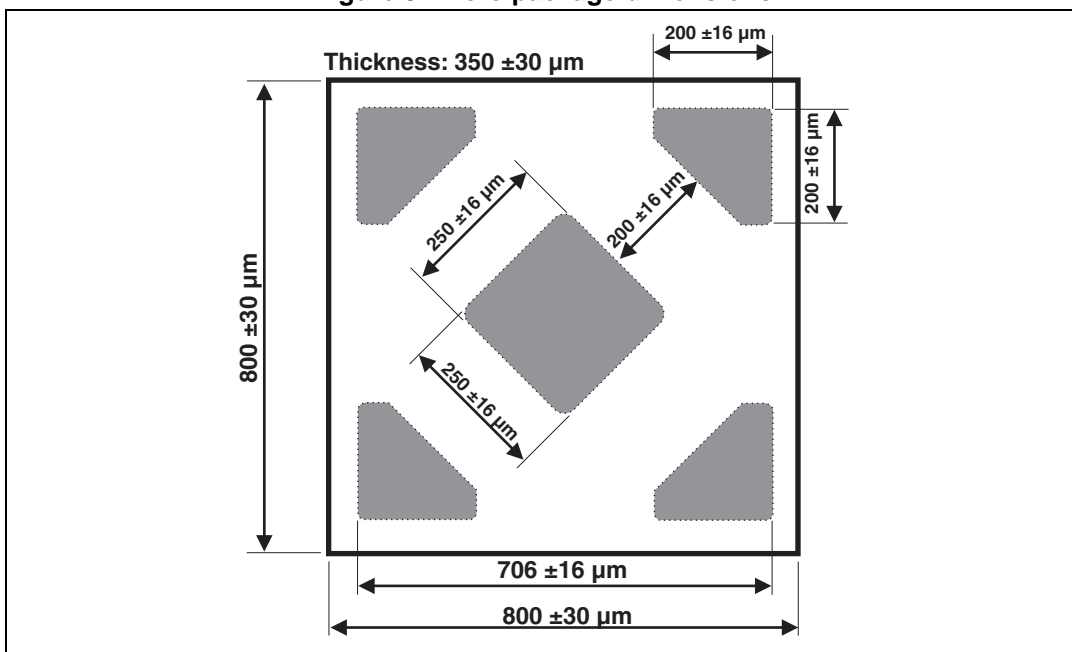
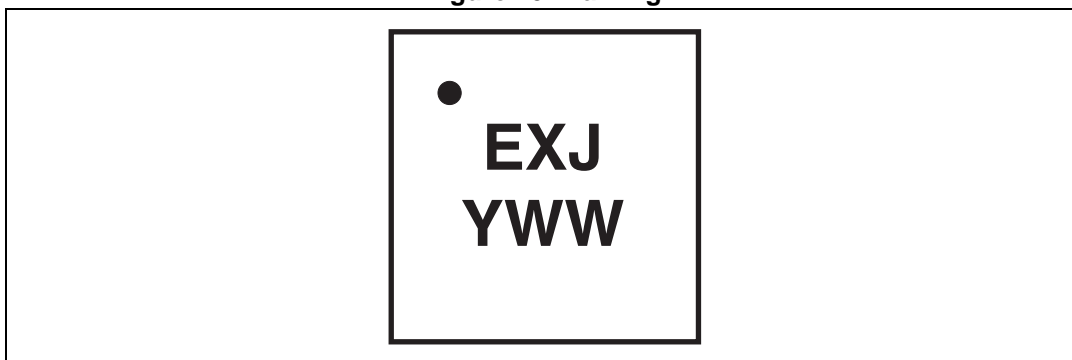
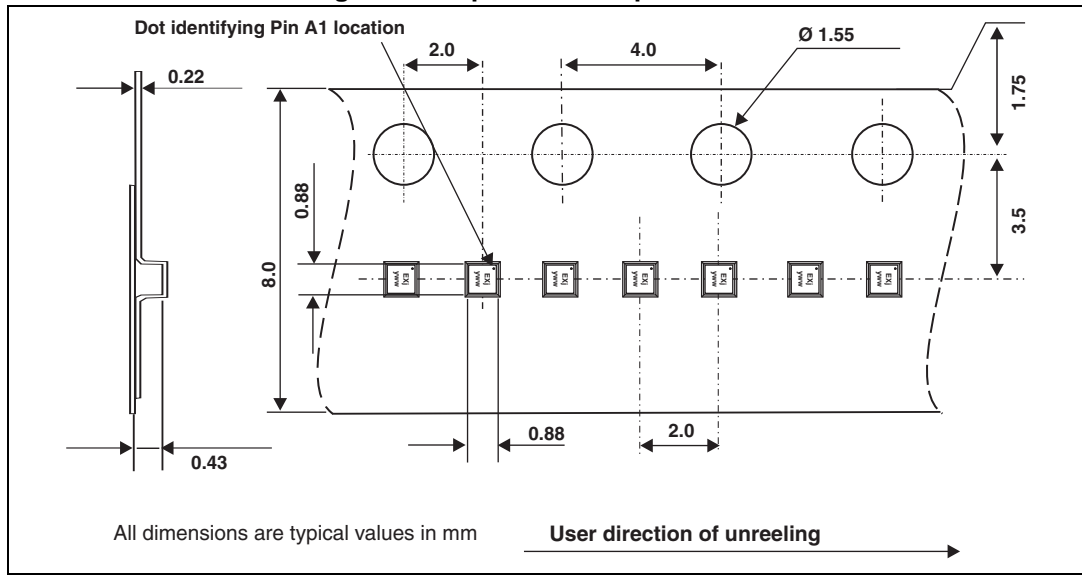

Figure 10. Marking



Note: The marking codes can be rotated by 90° or 180° to differentiate assembly location. In no case should this product marking be used to orient the component for its placement on a PCB. Only pin 1 mark is to be used for this purpose.

Figure 11. Tape and reel specification



3 Recommendation on PCB assembly

3.1 PCB design recommendations

- PCB pad design: Non solder mask defined
- PCB pad size: see [Figure 12](#).
- Solder mask opening: 50 µm between the edge of the pad and the edge of the solder mask

3.2 Stencil recommendations

- Stencil aperture: see [Figure 12](#).
- Stencil thickness: 75 µm

Figure 12. Micro package footprint and stencil (dimensions in mm)

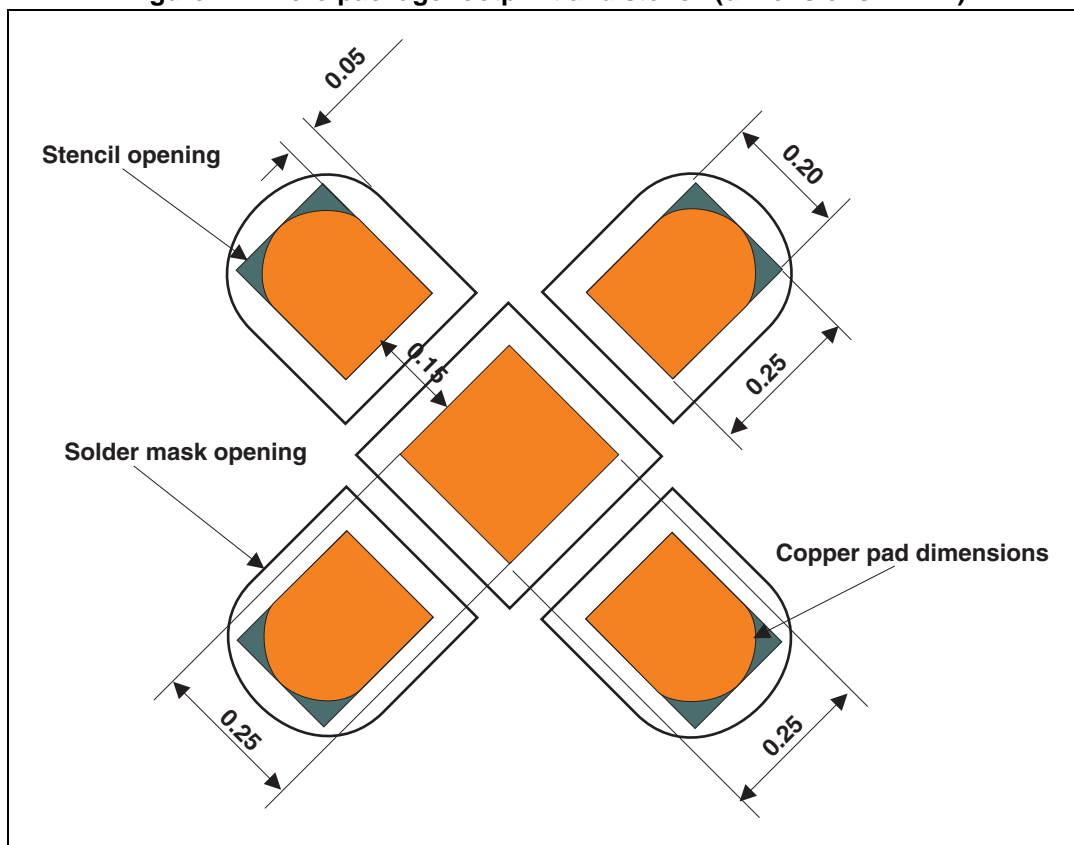

3.3 Solder paste recommendations

Near eutectic 95.8% Sn, 3.5% Ag, 0.7% Cu solder paste, Type 4.

4 Ordering information

Figure 13. Ordering information scheme

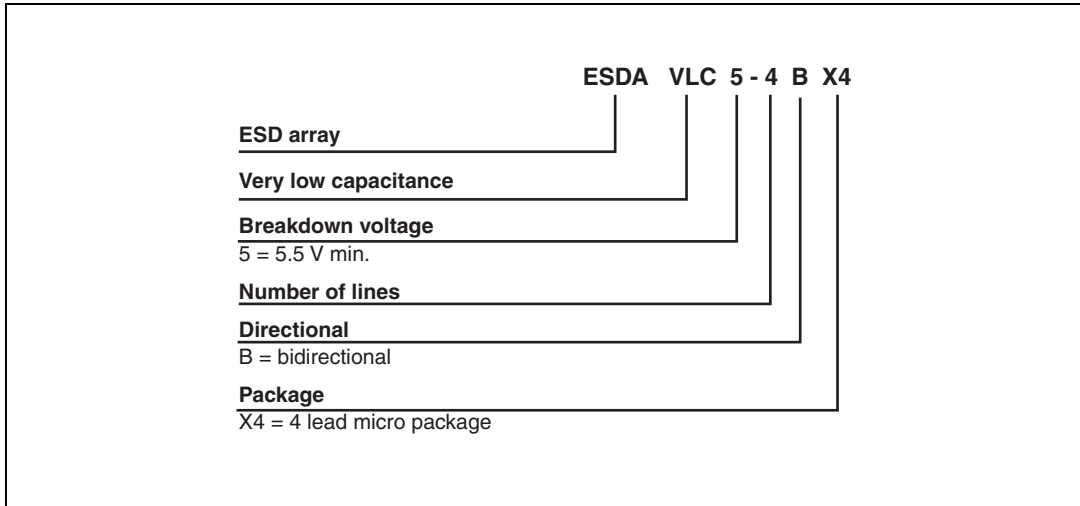

Table 3. Ordering information

Order code	Marking	Weight	Base qty	Delivery mode
ESDAVLC5-4BX4	EX ⁽¹⁾	0.504 mg	10 000	Tape and reel

1. The marking codes can be rotated by multiples of 90° to differentiate assembly location

5 Revision history

Table 4. Document revision history

Date	Revision	Changes
18-Sep-2012	1	First issue
05-Jun-2014	2	Updated values for dynamic resistance in Table 2 and added Figure 8 .

Please Read Carefully:

Information in this document is provided solely in connection with ST products. STMicroelectronics NV and its subsidiaries ("ST") reserve the right to make changes, corrections, modifications or improvements, to this document, and the products and services described herein at any time, without notice.

All ST products are sold pursuant to ST's terms and conditions of sale.

Purchasers are solely responsible for the choice, selection and use of the ST products and services described herein, and ST assumes no liability whatsoever relating to the choice, selection or use of the ST products and services described herein.

No license, express or implied, by estoppel or otherwise, to any intellectual property rights is granted under this document. If any part of this document refers to any third party products or services it shall not be deemed a license grant by ST for the use of such third party products or services, or any intellectual property contained therein or considered as a warranty covering the use in any manner whatsoever of such third party products or services or any intellectual property contained therein.

UNLESS OTHERWISE SET FORTH IN ST'S TERMS AND CONDITIONS OF SALE ST DISCLAIMS ANY EXPRESS OR IMPLIED WARRANTY WITH RESPECT TO THE USE AND/OR SALE OF ST PRODUCTS INCLUDING WITHOUT LIMITATION IMPLIED WARRANTIES OF MERCHANTABILITY, FITNESS FOR A PARTICULAR PURPOSE (AND THEIR EQUIVALENTS UNDER THE LAWS OF ANY JURISDICTION), OR INFRINGEMENT OF ANY PATENT, COPYRIGHT OR OTHER INTELLECTUAL PROPERTY RIGHT.

ST PRODUCTS ARE NOT DESIGNED OR AUTHORIZED FOR USE IN: (A) SAFETY CRITICAL APPLICATIONS SUCH AS LIFE SUPPORTING, ACTIVE IMPLANTED DEVICES OR SYSTEMS WITH PRODUCT FUNCTIONAL SAFETY REQUIREMENTS; (B) AERONAUTIC APPLICATIONS; (C) AUTOMOTIVE APPLICATIONS OR ENVIRONMENTS, AND/OR (D) AEROSPACE APPLICATIONS OR ENVIRONMENTS. WHERE ST PRODUCTS ARE NOT DESIGNED FOR SUCH USE, THE PURCHASER SHALL USE PRODUCTS AT PURCHASER'S SOLE RISK, EVEN IF ST HAS BEEN INFORMED IN WRITING OF SUCH USAGE, UNLESS A PRODUCT IS EXPRESSLY DESIGNATED BY ST AS BEING INTENDED FOR "AUTOMOTIVE, AUTOMOTIVE SAFETY OR MEDICAL" INDUSTRY DOMAINS ACCORDING TO ST PRODUCT DESIGN SPECIFICATIONS. PRODUCTS FORMALLY ESCC, QML OR JAN QUALIFIED ARE DEEMED SUITABLE FOR USE IN AEROSPACE BY THE CORRESPONDING GOVERNMENTAL AGENCY.

Resale of ST products with provisions different from the statements and/or technical features set forth in this document shall immediately void any warranty granted by ST for the ST product or service described herein and shall not create or extend in any manner whatsoever, any liability of ST.

ST and the ST logo are trademarks or registered trademarks of ST in various countries.

Information in this document supersedes and replaces all information previously supplied.

The ST logo is a registered trademark of STMicroelectronics. All other names are the property of their respective owners.

© 2014 STMicroelectronics - All rights reserved

STMicroelectronics group of companies

Australia - Belgium - Brazil - Canada - China - Czech Republic - Finland - France - Germany - Hong Kong - India - Israel - Italy - Japan - Malaysia - Malta - Morocco - Philippines - Singapore - Spain - Sweden - Switzerland - United Kingdom - United States of America

www.st.com