

# Monitoring Relays

## 1-Phase True RMS AC Over/Under Voltage

### Types DUB02, PUB02

CARLO GAVAZZI



DUB02



PUB02

- TRMS AC over/under voltage monitoring relays
- Measuring if power supply is within set limits
- Measure their own power supply
- Measuring ranges: 24, 115, 230 VAC
- Power ON delay 1 or 6 s selectable by DIP-switch
- Separately adjustable upper/lower level on relative scale
- Adjustable delay on alarm or on recovery (0.1 to 30 s)
- Programmable latching or inhibit at set level
- Output: 8 A SPDT relay N.D. or N.E. selectable
- For mounting on DIN-rail in accordance with DIN/EN 50 022 (DUB02) or plug-in module (PUB02)
- 22.5 mm Euronorm housing (DUB02) or 36 mm plug-in module (PUB02)
- LED indication for relay, alarm and power supply ON

### Product Description

DUB02 and PUB02 are precise TRMS AC window voltage monitoring relays. The relays monitor their own power supply which is selectable by DIP-switch (24, 115 or 230 VAC). The advantage of using the latch function is that the relay can be kept energized

even after the end of the alarm condition. Inhibit function can be used to avoid relay operation when not desired (maintenance, transitions). The LED's indicate the state of the alarm and the output relay.

### Ordering Key

**DUB 02 C T23**



### Type Selection

Mounting	Output	Supply: 24, 115, 230 VAC
DIN-rail	SPDT	<b>DUB 02 C T23</b>
Plug-in	SPDT	<b>PUB 02 C T23</b>

### Input Specifications

<b>Input</b> (voltage level) DUB02 PUB02	Terminals A1, A2 Terminals 2, 10 Measure their own power supply	
<b>Measuring ranges</b> Direct Selectable by DIP-switch 24 VAC 115 VAC 230 VAC	<b>Upper level</b> -5% to +20% 22.8 to 28.8 V	<b>Lower level</b> -20% to +5% 19.2 to 25.2 V
<b>Contact input</b> DUB02 PUB02 Disabled Enabled Pulse width	Terminals Z1, Z2 Terminals 8, 9 > 10 kΩ < 500 Ω > 500 ms	
<b>Hysteresis</b>	~ 2% of set value - fixed	

### Output Specifications

<b>Output</b> Rated insulation voltage	SPDT relay 250 VAC
<b>Contact ratings</b> (AgSnO <sub>2</sub> ) Resistive loads AC 1 DC 12 Small inductive loads AC 15 DC 13	μ 8 A @ 250 VAC 5 A @ 24 VDC 2.5 A @ 250 VAC 2.5 A @ 24 VDC
<b>Mechanical life</b>	≥ 30 x 10 <sup>6</sup> operations
<b>Electrical life</b>	≥ 10 <sup>5</sup> operations (at 8 A, 250 V, cos φ = 1)
<b>Operating frequency</b>	≤ 7200 operations/h
<b>Dielectric strength</b> Dielectric voltage Rated impulse withstand volt.	2 kVAC (rms) 4 kV (1.2/50 μs)



## Supply Specifications

<b>Power supply</b> Rated operational voltage through terminals: A1 and A2 (DUB02) or 2 and 10 (PUB02)  Voltage interruption Dielectric voltage	Overvoltage cat. III (IEC 60664, IEC 60038)  24 VAC $\pm$ 20%, 115 VAC $\pm$ 20% or 230 VAC $\pm$ 20%  $\leq$ 40 ms None
<b>Dielectric voltage</b> Supply to output	4 kV
<b>Rated operational power</b>	4 VA

## General Specifications

<b>Power ON delay</b>	1 s $\pm$ 0.5 s or 6 s $\pm$ 0.5 s
<b>Reaction time</b>  Alarm ON delay Alarm OFF delay	(input signal variation from -20% to +20% or from +20% to -20% of set value)  < 200 ms < 200 ms
<b>Accuracy</b> Temperature drift Delay ON alarm Repeatability	(15 min warm-up time) $\pm$ 1000 ppm/ $^{\circ}$ C $\pm$ 10% on set value $\pm$ 50 ms $\pm$ 0.5% on full-scale
<b>Indication for</b> Power supply ON Alarm ON  Output relay ON	LED, green LED, red (flashing 2 Hz during delay time) LED, yellow
<b>Environment</b> Degree of protection Pollution degree Operating temperature Storage temperature	IP 20 3 (DUB02), 2 (PUB02) -20 to 60 $^{\circ}$ C, R.H. < 95% -30 to 80 $^{\circ}$ C, R.H. < 95%
<b>Housing</b> Dimensions Material	DUB02 PUB02 22.5 x 80 x 99.5 mm 36 x 80 x 94 mm PA66 or Noryl
<b>Weight</b>	Approx. 150 g
<b>Screw terminals</b> Tightening torque	Max. 0.5 Nm acc. to IEC 60947
<b>Product standard</b>	EN 60255-6
<b>Approvals</b>	UL, CSA
<b>CE Marking</b>  EMC Immunity  Emissions	L.V. Directive 2006/95/EC EMC Directive 2004/108/EC  According to EN 60255-26 According to EN 61000-6-2 According to EN 60255-26 According to EN 61000-6-3

## Mode of Operation

DUB02 and PUB02 monitor the TRMS value of their own power supply.

### Example 1

(no connection between terminals Z1, Z2 or 8, 9 - Delay ON alarm - N.E. relay)

The relay operates and the yellow LED is ON as long as the measured value is within the upper and lower limits.

The relay releases after the adjustable time delay when the measured voltage

exceeds the upper set level or drops below the lower set level. The red LED flashes until the delay time has expired or the measured value falls off the limits.

### Example 2

(connection between terminals Z1, Z2 or 8, 9 - latching function enabled - delay on recovery - N.E. relay)

The relay operates and the yellow LED is ON as long as the measured value is within

the upper and lower limits. The relay releases and latches in alarm position as soon as the measured voltage exceeds the upper set level or drops below the lower set level. Provided that the voltage has dropped below the upper set level (minus hysteresis) or exceeded the lower set level (plus hysteresis) for more than the set delay time, the relay operates when the interconnections between terminals Z1,

Z2 or 8, 9 are interrupted. The red LED flashes until the delay time has expired or the measured value falls off the limits.

## Function/Range/Level and Time Delay Setting

Adjust the input range setting the DIP switches 5 and 6 as shown on the right.  
 Select the desired function setting the DIP switches 1 to 4 as shown on the right.  
 To access the DIP switches open the grey plastic cover as shown on the right.

**Selection of level and time delay:**

**Upper knob:** Setting of upper level on relative scale: -5% to +20% of set power supply voltage.

**Centre knob:** Setting of lower level on relative scale: -20% to +5% of set power supply voltage.

**Lower knob:** Setting of delay on alarm time on absolute scale (0.1 to 30 s).

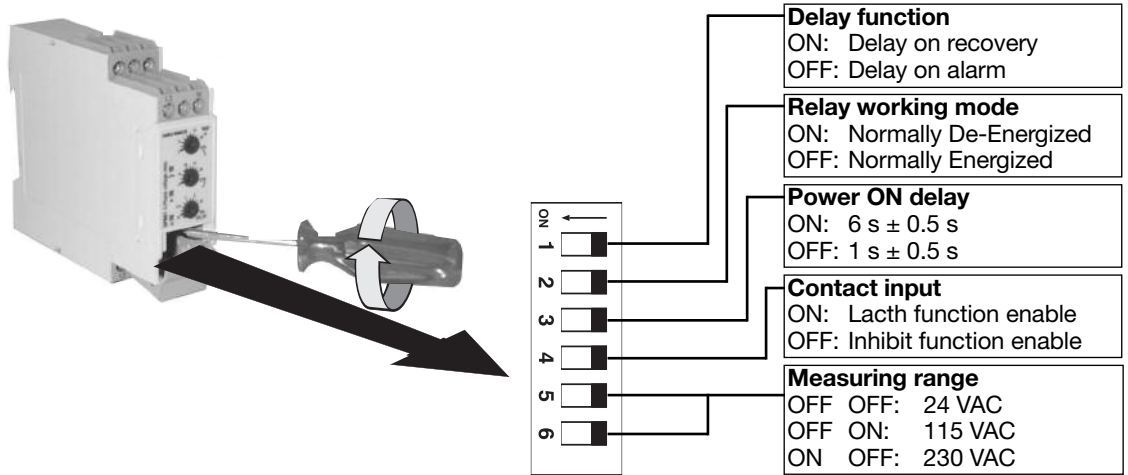

## Operation Diagrams

**Delay ON alarm - N.E. relay**

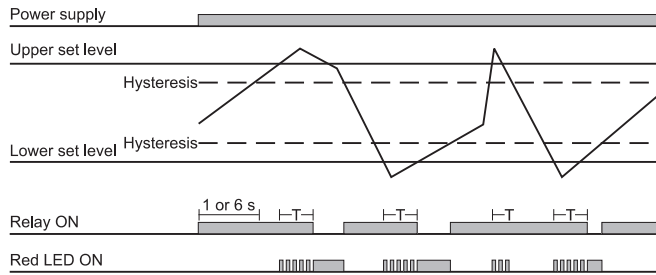

**Delay ON alarm - Latch function - N.E. relay**

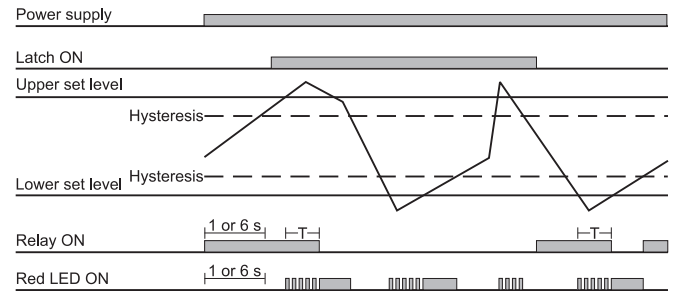

**Delay ON recovery - N.E. relay**

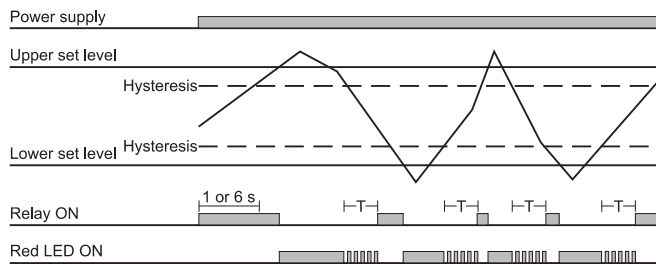

**Delay ON recovery - Inhibit function - N.E. relay**

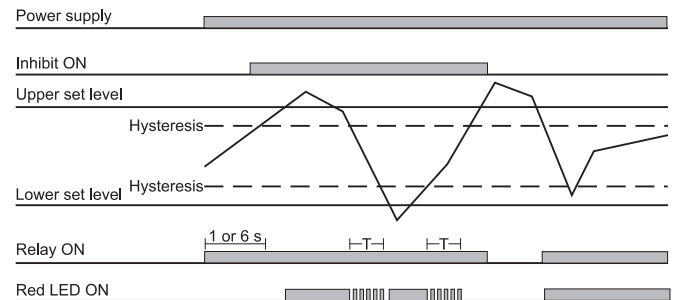

## Wiring Diagrams

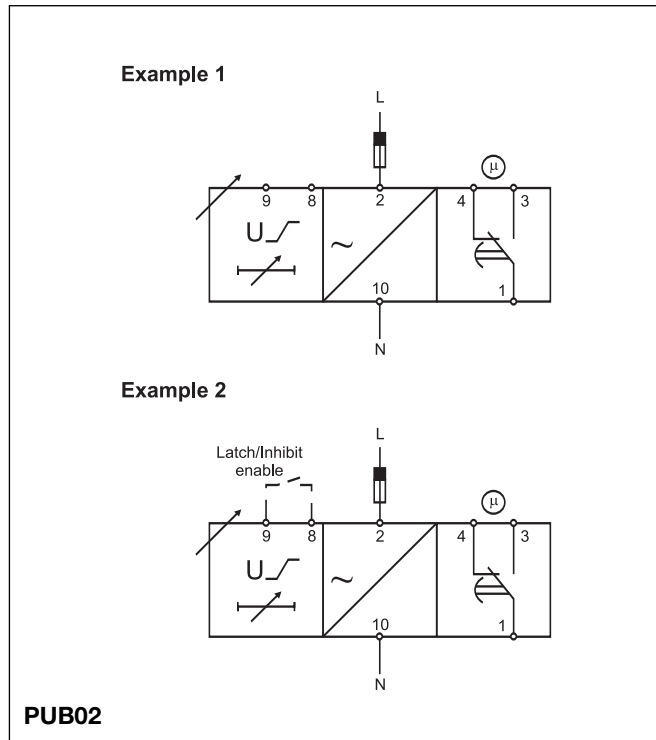
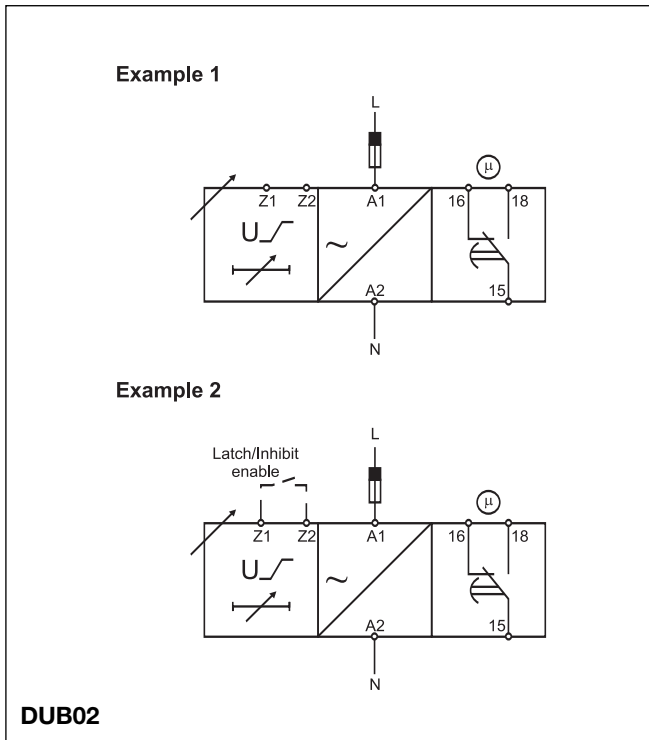

## Dimensions

