

# Solid State Relays G3PA

## Extremely Thin Relays Integrated with Heat Sinks

- Downsizing achieved through optimum design of heat sink.
- Mounting possible via screws or via DIN track.
- Close mounting possible for linking terminals. (Except for G3PA-260B-VD and G3PA-450B-VD-2.)
- Applicable with 3-phase loads.
- Replaceable power element cartridges.
- Comply with VDE 0160 (finger protection), with a dielectric strength of 4,000 V between input and load.
- Comply with VDE 0805, IEC 950.
- Certified by UL, CSA, and VDE (reinforced insulation).



## Model Number Structure

### ■ Model Number Legend

G3PA-□□□□-□-□  
 1 2 3 4 5 6 7

**1. Basic Model Name**

G3PA: Solid State Relay

**2. Rated Load Power Supply Voltage**

2: 200 VAC  
 4: 400 VAC

**3. Rated Load Current**

10: 10 A  
 20: 20 A  
 30: 30 A  
 40: 40 A  
 50: 50 A  
 60: 60 A

**4. Terminal Type**

B: Screw terminals

**5. Zero Cross Function**

Blank: Equipped with zero cross function  
 L: Not equipped with zero cross function

**6. Certification**

VD: Certified by UL, CSA, and VDE

**7. Special Specifications**

Blank: Standard models  
 2: 480-V models

SSR

# Ordering Information

## ■ List of Models

Model	Isolation	Zero cross function	Indicator	Rated output load	Rated input voltage	
G3PA-210B-VD	Phototriac coupler	Yes	Yes	10 A at 24 to 240 VAC	5 to 24 VDC	
G3PA-220B-VD				20 A at 24 to 240 VAC		
G3PA-240B-VD				40 A at 24 to 240 VAC		
G3PA-260B-VD				60 A at 24 to 240 VAC		
G3PA-210BL-VD		No		10 A at 24 to 240 VAC		
G3PA-220BL-VD				20 A at 24 to 240 VAC		
G3PA-240BL-VD				40 A at 24 to 240 VAC		
G3PA-260BL-VD				60 A at 24 to 240 VAC		
G3PA-210B-VD		Yes			10 A at 24 to 240 VAC	24 VAC
G3PA-220B-VD					20 A at 24 to 240 VAC	
G3PA-240B-VD					40 A at 24 to 240 VAC	
G3PA-260B-VD					60 A at 24 to 240 VAC	
G3PA-420B-VD					20 A at 180 to 400 VAC	12 to 24 VDC
G3PA-430B-VD					30 A at 180 to 400 VAC	
G3PA-420B-VD-2					20 A at 200 to 480 VAC	
G3PA-430B-VD-2					30 A at 200 to 480 VAC	
G3PA-450B-VD-2		50 A at 200 to 480 VAC				

**Note:** When ordering, specify the rated input voltage.

## Replacement Parts

Name	Carry current	Load voltage range	Model	Applicable SSR	VDE certification	
Power Device Cartridge	10 A	19 to 264 VAC	G32A-A10-VD DC5-24	G3PA-210B-VD DC5-24	Yes	
			G32A-A10L-VD DC5-24	G3PA-210BL-VD DC5-24		
			G32A-A10-VD AC24	G3PA-210B-VD AC24		
			G32A-A20-VD DC5-24	G3PA-220B-VD DC5-24		
	20 A		G32A-A20L-VD DC5-24	G3PA-220BL-VD DC5-24		
			G32A-A20-VD AC24	G3PA-220B-VD AC24		
			40 A	G32A-A40-VD DC5-24		G3PA-240B-VD DC5-24
				G32A-A40L-VD DC5-24		G3PA-240BL-VD DC5-24
	G32A-A40-VD AC24			G3PA-240B-VD AC24		
	60 A			G32A-A60-VD DC5-24		G3PA-260B-VD DC5-24
			G32A-A60L-VD DC5-24	G3PA-260BL-VD DC5-24		
			G32A-A60-VD AC24	G3PA-260B-VD AC24		
			20 A	150 to 440 VAC		G32A-A420-VD DC12-24
	G32A-A430-VD DC12-24					G3PA-430B-VD DC12-24
	20 A		180 to 528 VAC	G32A-A420-VD-2 DC12-24		G3PA-420B-VD-2 DC12-24
				G32A-A430-VD-2 DC12-24		G3PA-430B-VD-2 DC12-24
G32A-A450-VD-2 DC12-24		G3PA-450B-VD-2 DC12-24				

## ■ Other Units (Order Separately)

### Units that Enable 2-line Switching of 3-phase Power

Name	Current flow	Model	Applicable SSR
Short-circuit Unit	10 A	G32A-D20	G3PA-210B-VD, G3PA-210BL-VD
	20 A		G3PA-220B-VD, G3PA-220BL-VD G3PA-420B-VD, G3PA-420B-VD-2
	30 A	G32A-D40	G3PA-430B-VD, G3PA-430B-VD-2
	40 A		G3PA-240B-VD, G3PA-240BL-VD

# Specifications

## ■ Ratings (at an Ambient Temperature of 25°C)

### Input

Model	Rated voltage	Operating Voltage range	Input current impedance	Voltage level	
				Must operate voltage	Must release voltage
G3PA-210B-VD	5 to 24 VDC	4 to 30 VDC	7 mA max.	4 VDC max.	1 VDC min.
G3PA-220B-VD					
G3PA-240B-VD					
G3PA-260B-VD					
G3PA-210BL-VD	5 to 24 VDC	4 to 30 VDC	20 mA max.	4 VDC max.	1 VDC min.
G3PA-220BL-VD					
G3PA-240BL-VD					
G3PA-260BL-VD					
G3PA-210B-VD	24 VAC	19.2 to 26.4 VAC	1.4 kΩ±20%	19.2 VAC max.	4.8 VAC min.
G3PA-220B-VD					
G3PA-240B-VD					
G3PA-260B-VD					
G3PA-420B-VD	12 to 24 VDC	9.6 to 30 VDC	7 mA max.	9.2 VDC max.	1 VDC min.
G3PA-430B-VD					
G3PA-420B-VD-2					
G3PA-430B-VD-2					
G3PA-450B-VD-2					

### Output

Model	Applicable load			
	Rated load voltage	Load voltage range	Load current	Inrush current
G3PA-210B(L)-VD	24 to 240 VAC (50/60 Hz)	19 to 264 VAC (50/60 Hz)	0.1 to 10 A	150 A (60 Hz, 1 cycle)
G3PA-220B(L)-VD			0.1 to 20 A	220 A (60 Hz, 1 cycle)
G3PA-240B(L)-VD			0.5 to 40 A	440 A (60 Hz, 1 cycle)
G3PA-260B(L)-VD			0.5 to 60 A	440 A (60 Hz, 1 cycle)
G3PA-420B-VD	180 to 400 VAC (50/60 Hz)	150 to 440 VAC (50/60 Hz)	0.5 to 20 A	220 A (60 Hz, 1 cycle)
G3PA-430B-VD			0.5 to 30 A	440 A (60 Hz, 1 cycle)
G3PA-420B-VD-2	200 to 480 VAC (50/60 Hz)	180 to 528 VAC (50/60 Hz)	0.5 to 20 A	220 A (60 Hz, 1 cycle)
G3PA-430B-VD-2			0.5 to 30 A	440 A (60 Hz, 1 cycle)
G3PA-450B-VD-2			0.5 to 50 A	440 A (60 Hz, 1 cycle)

Refer to *Engineering Data* for further details.

## ■ Characteristics

Item	G3PA-210B(L)-VD	G3PA-220B(L)-VD	G3PA-240B(L)-VD	G3PA-260B(L)-VD	G3PA-420B-VD	G3PA-420B-VD-2	G3PA-430B-VD	G3PA-430B-VD-2	G3PA-450B-VD-2
Operate time	1/2 of load power source cycle + 1 ms max. (DC Input, -B models) 1 1/2 of load power source cycle + 1 ms max. (AC Input) 1 ms max. (-BL models)								
Release time	1/2 of load power source cycle + 1 ms max. (DC Input) 1 1/2 of load power source cycle + 1 ms max. (AC Input)								
Output ON voltage drop	1.6 V (RMS) max.				1.8 V (RMS) max.				
Leakage current	5 mA max. (at 100 VAC) 10 mA max. (at 200 VAC)		10 mA max. (at 100 VAC) 20 mA max. (at 200 VAC)		20 mA max. (at 400 VAC)	20 mA max. (at 480 VAC)	20 mA max. (at 400 VAC)	20 mA max. (at 480 VAC)	
I <sup>2</sup> t	260 A <sup>2</sup> s		1,260 A <sup>2</sup> s		260 A <sup>2</sup> s	1,800 A <sup>2</sup> s	1,800 A <sup>2</sup> s		1,800 A <sup>2</sup> s
Insulation resistance	100 MΩ min. (at 500 VDC)								
Dielectric strength	4,000 VAC, 50/60 Hz for 1 min								
Vibration resistance	Destruction: 10 to 55 to 10 Hz, 0.375-mm single amplitude (Mounted to DIN track)								
Shock resistance	Destruction: 300 m/s <sup>2</sup> (mounted to DIN track)								
Ambient temperature	Operating: -30°C to 80°C (with no icing or condensation) Storage: -30°C to 100°C (with no icing or condensation)								
Certified standards	UL508, CSA C22.2 (No.14, No.950), EN60950 File No. 5915ÜG				UL508, CSA C22.2 (No.14), EN60947-4-3 File No. 6642ÜG	UL508, CSA C22.2 (No.14), EN60947-4-3 File No. 133127ÜG	UL508, CSA C22.2 (No.14), EN60947-4-3 File No. 6642ÜG	UL508, CSA C22.2 (No.14), EN60947-4-3 File No. 133127ÜG	
Ambient humidity	Operating: 45% to 85%								
Weight	Approx. 260 g	Approx. 340 g	Approx. 460 g	Approx. 900 g	Approx. 290 g	Approx. 290 g	Approx. 410 g	Approx. 410 g	Approx. 900 g

# Operation

## ■ Replacement Parts

### G32A-A Power Device Cartridge

The G32A-A Power Device Cartridge (a Triac Unit) can be replaced with a new one. When the temperature indicator has changed from pink to red, the triac circuitry may have malfunctioned possibly by an excessive flow of current, in which case, dismount the damaged cartridge for replacement. The damaged cartridge can be replaced with a new one without disconnecting the wires from the G3PA.

Improve the heat radiation efficiency of the G3PA before replacing the cartridge.

The G32A-A Power Device Cartridge can withstand an excessive current for a short period of time, such as may be caused accidentally by the short circuitry of the load, in which case the temperature indicator will not turn red.

Be sure to turn OFF the power supply when replacing the Cartridge. Supplying power with the Cartridge removed may result in malfunction.

### Appearance

G32A-A10(L)-VD    G32A-A20(L)-VD    G32A-A40(L)-VD    G32A-A60(L)-VD

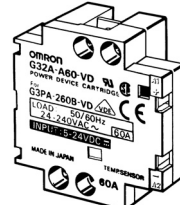
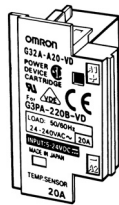
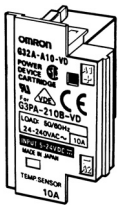

G32A-A420-VD(-2)    G32A-A430-VD(-2)    G32A-A450-VD-2

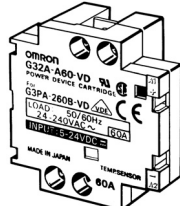
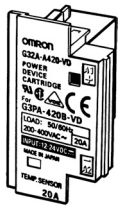

### Replacing Power Device Cartridges

When replacing Power Device Cartridges, use the specified model. Using a Power Device Cartridge other than the specified one will result in faulty operation and destruction of the elements.

SSR

## ■ Replacement Procedure

### G32A-A10(L)-VD/G32A-A20(L)-VD/G32A-A420-VD(-2)

Use the special tool (provided) to extract the cartridge for replacement with a new one.

#### Extraction

Follow the procedures below to dismantle the Power Device Cartridge from the G3PA.

1. Switch off the power.
2. Remove the terminal cover.
3. Hook the indented part of the cartridge with the tool and pull up on the cartridge to remove it.

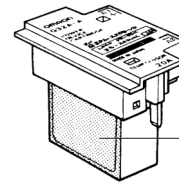
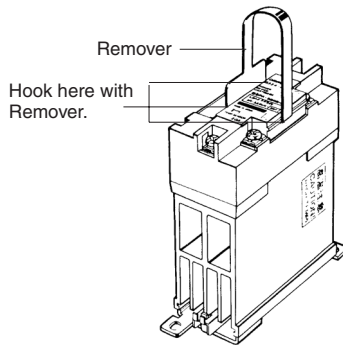

2. Make sure that there is no dust or pieces of wire on the heat sink of the G32A-A or the G3PA.
3. Insert the cartridge into the opening of the G3PA so that the letters on the cartridge and those on the G3PA are in the same direction and side A and side B are even.

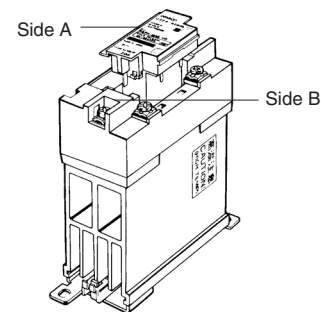

#### Mounting

Follow the procedures below to mount the Power Device Cartridge on the G3PA.

1. Apply silicone grease (provided with the G32A-A) to the entire surface of the heat sink.

4. Attach the terminal cover.
5. Switch on the power and check the G3PA to be sure it works properly.

### G32A-A40(L)-VD/G32A-A60(L)-VD/G32A-A430-VD(-2)/G32A-A450-VD-2

The G32A Power Device Cartridge is mounted and secured with screws to the G3PA Unit.

#### Extraction

Follow the procedures below to dismantle the G32A-A Power Device Cartridge from the G3PA.

1. Switch off the power.
2. Remove the terminal cover.
3. Loosen the two centered screws on the sides to dismantle the cartridge. The screws are connected to terminals 1 and 2.

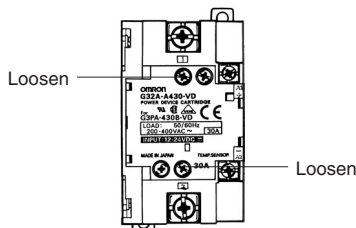

4. Loosen the screws on both the corners.

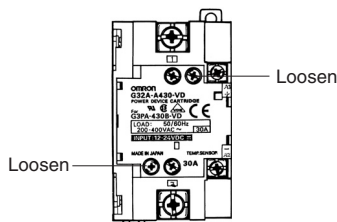

5. Hold the indented part of both the corners to dismantle the cartridge.

#### Mounting

1. Apply silicone grease to the entire surface of the heat sink.

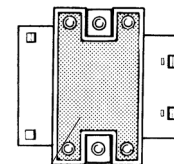

2. Make sure that there is no dust or pieces of wire on the heat sink of the G32A-A or the G3PA.

3. Insert the cartridge into the opening of the G3PA so that side A and side B are even.

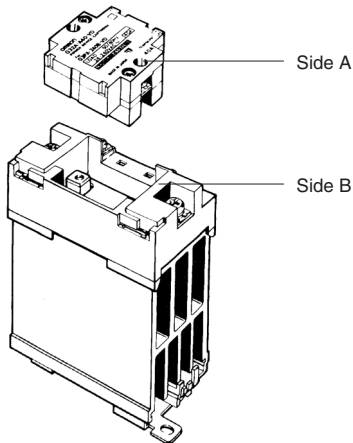

4. Tighten the screws on both the corners with a tightening torque of 0.59 to 0.78 N·m.
5. Tighten the screws on both the sides with a tightening torque of 0.59 to 0.78 N·m.
6. Attach the terminal cover.
7. Switch on the power and check the G3PA to be sure it works properly.

## ■ Linking Terminal Connection

- Connecting with linking terminal for G3PA-210B(L)-VD, -220B(L)-VD, -240B(L)-VD and G3PA-420B-VD(-2), G3PA-430B-VD(-2).

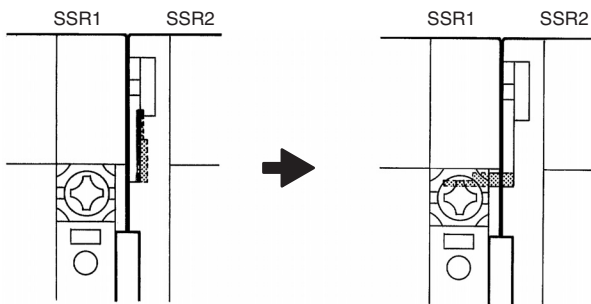

1. When SSRs are close mounted, loosen the M3.5 Sems screw and flip the linking terminal down.
2. Insert the linking terminal securely into the center of the screw and tighten the screw.

- Connecting with linking terminal for G32A.

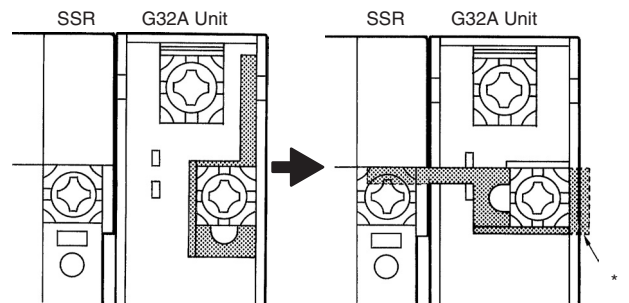

1. When SSR are close mounted, loosen the M3.5 Sems screw on the G32A and flip the linking terminal down.
2. Insert the linking terminal securely into the center of the screw and tighten the screw. Ensure that the linking terminal does not protrude.

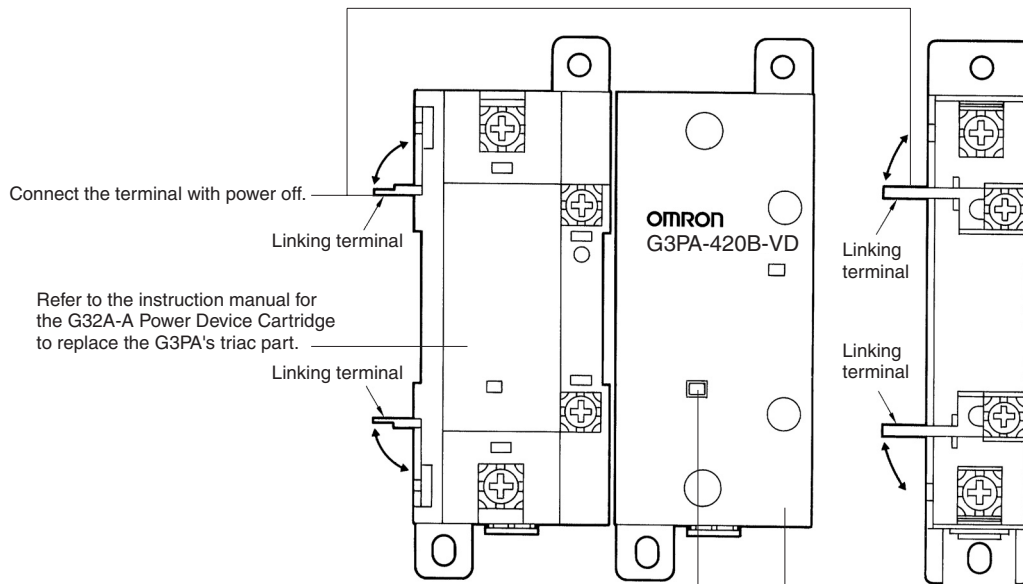

When the temperature indicator has turned from pink to red, the G32A-A Power Device Cartridge may have malfunctioned, in which case the cartridge must be replaced with a new one.

Use the terminal cover to prevent accidents due to electric shock.

SSR

# Engineering Data

## Load Current vs. Ambient Temperature

### Vertical Mounting

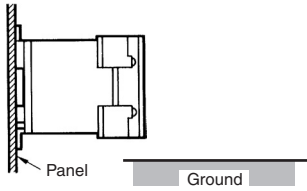

**G3PA-210B(L)-VD, G3PA-220B(L)-VD**

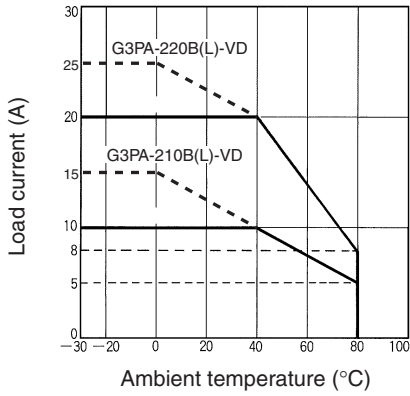

**G3PA-240B(L)-VD**

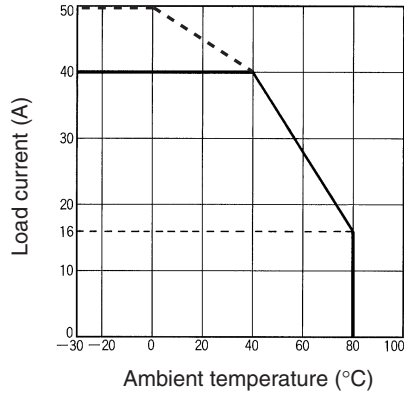

**G3PA-260B(L)-VD**

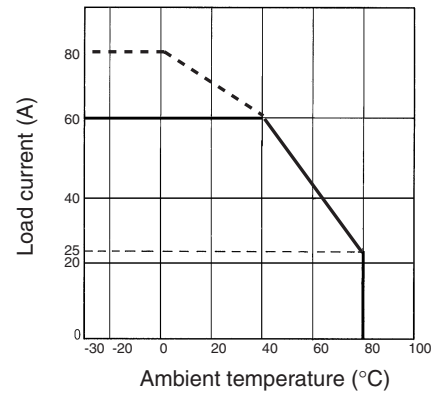

**G3PA-420B-VD, G3PA-420B-VD-2**

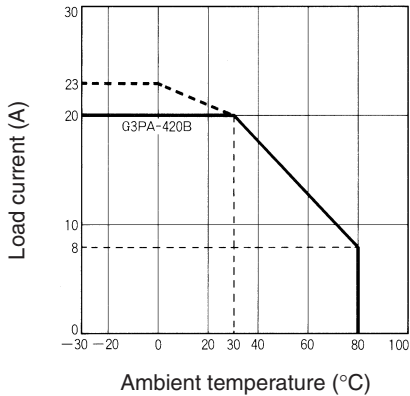

**G3PA-430B-VD, G3PA-430B-VD-2**

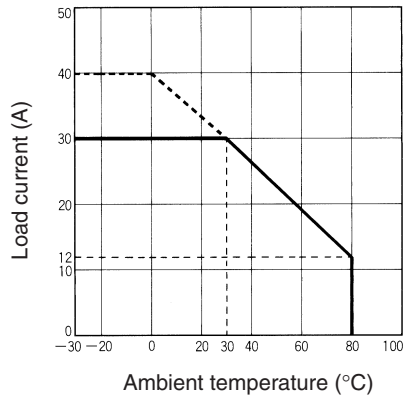

**G3PA-450B-VD-2**

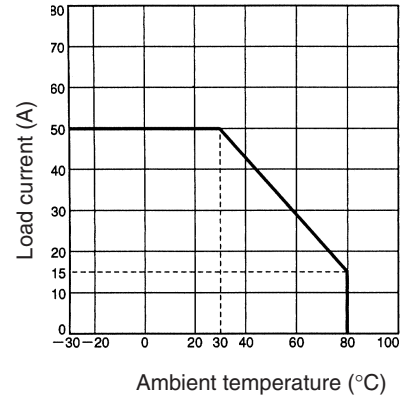

**Note:** Close mounting is possible for a maximum of three Units by reducing the load current by 20%. (A minimum clearance of 10 mm must be provided when mounting four or more Units.)



# Input Voltage vs. Input Current

G3PA-2□0B-VD

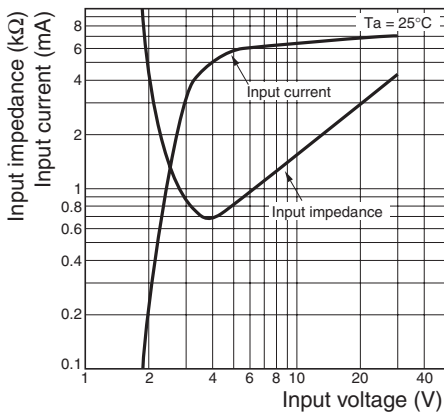

G3PA-4□0-VD, G3PA-4□-VD-2

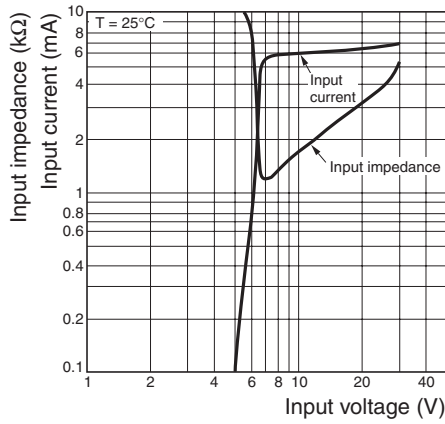

## Horizontal Mounting

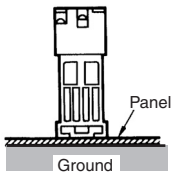

G3PA-210B(L)-VD, G3PA-220B(L)-VD

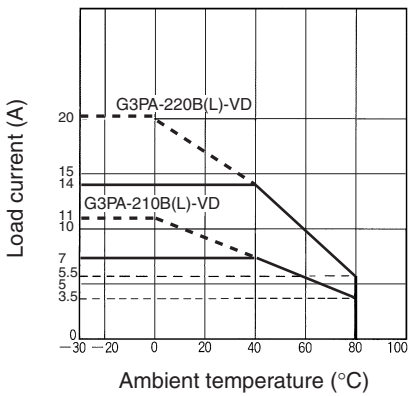

G3PA-240B(L)-VD

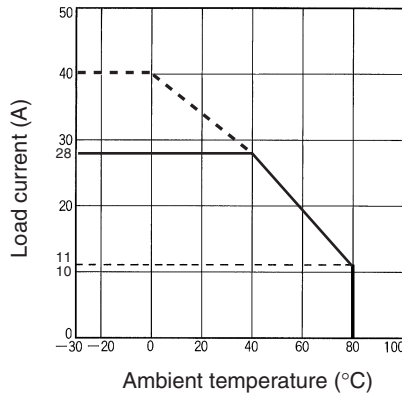

G3PA-260B(L)-VD

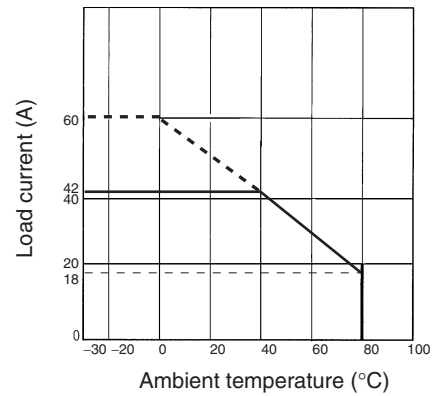

G3PA-420B-VD, G3PA-430B-VD  
G3PA-420B-VD-2, G3PA-430B-VD-2

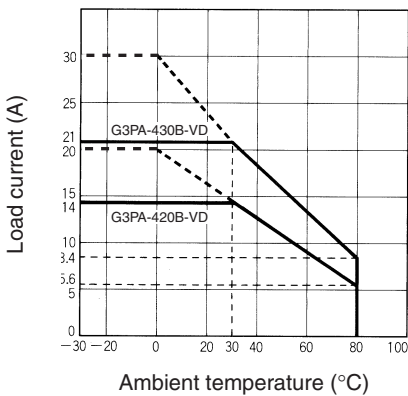

G3PA-450B-VD-2

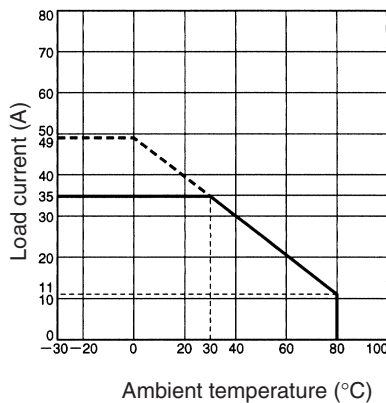

Close Mounting (Up to Three)

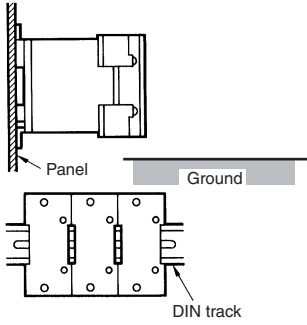

G3PA-210B(L)-VD, G3PA-220B(L)-VD

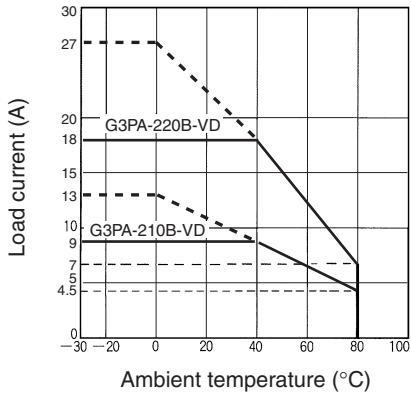

G3PA-240B(L)-VD

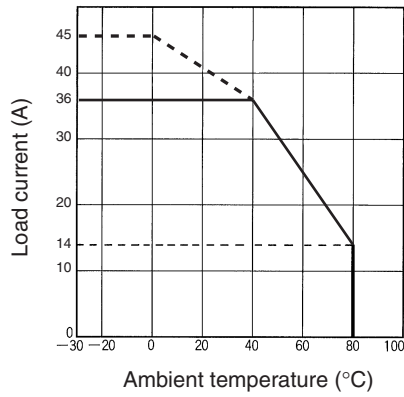

G3PA-260B(L)-VD

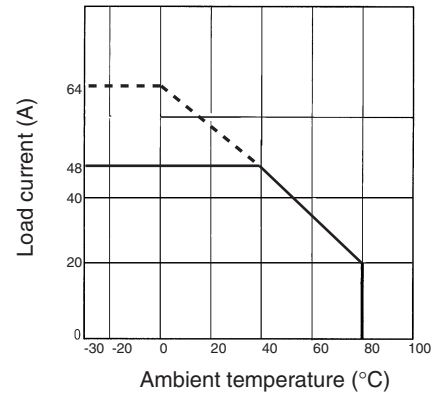

G3PA-420B-VD, G3PA-420B-VD-2

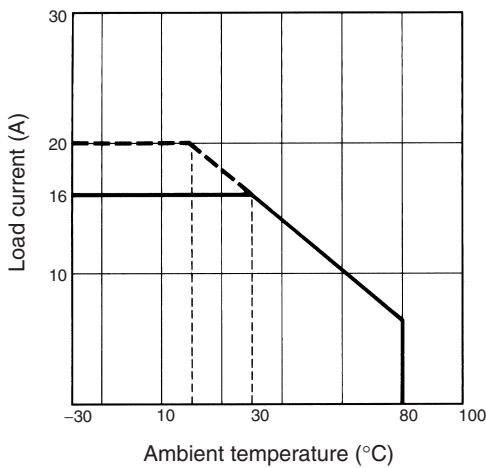

G3PA-430B-VD, G3PA-430B-VD-2

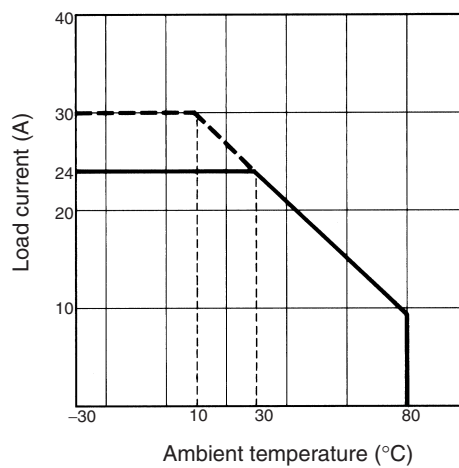

G3PA-450B-VD-2

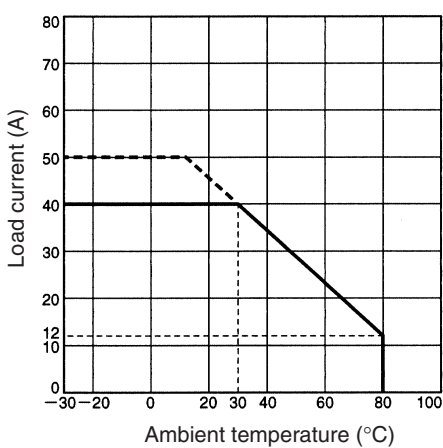

## One Cycle Surge Current: Non-repetitive

**Note:** Keep the inrush current to half the rated value if it occurs repetitively.

G3PA-210B(L)-VD

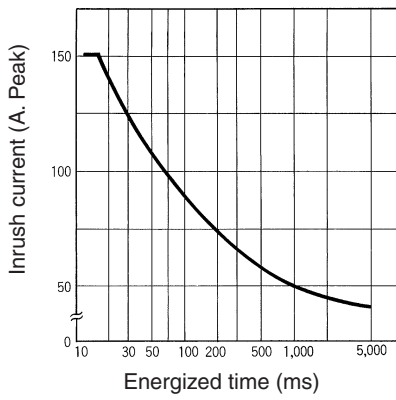

G3PA-220B(L)-VD, G3PA-420B-VD,  
G3PA-420B-VD-2

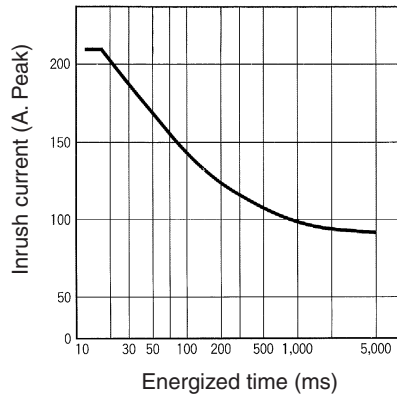

G3PA-240B(L)-VD/260B(L)-VD,  
G3PA-430B-VD, G3PA-430B-VD-2,  
G3PA-450B-VD-2

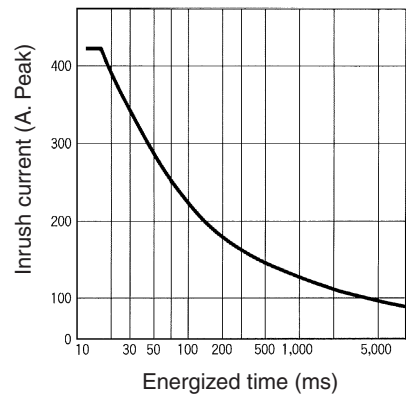

# Dimensions

Note: All units are in millimeters unless otherwise indicated.

## G3PA-210B(L)-VD

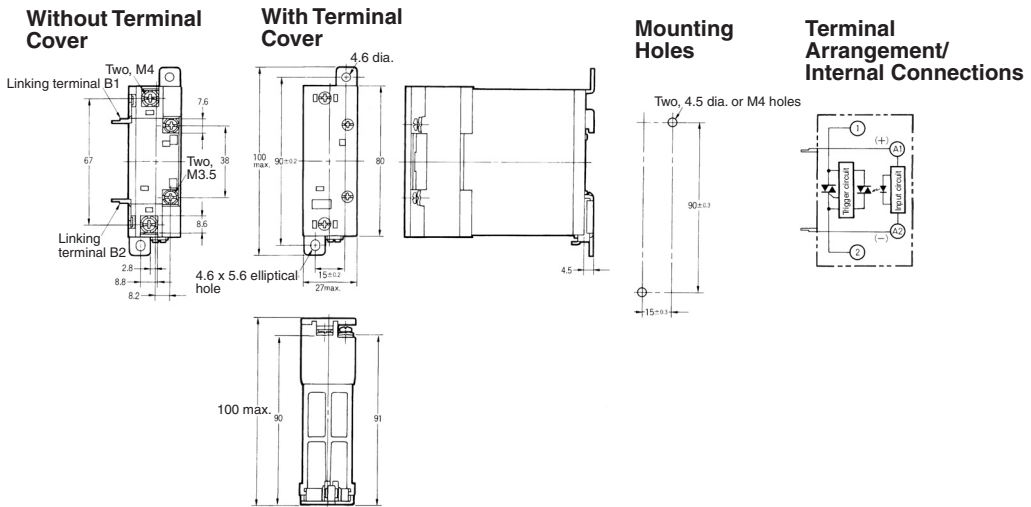
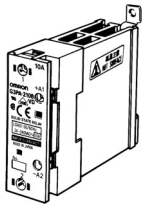

## G3PA-220B(L)-VD

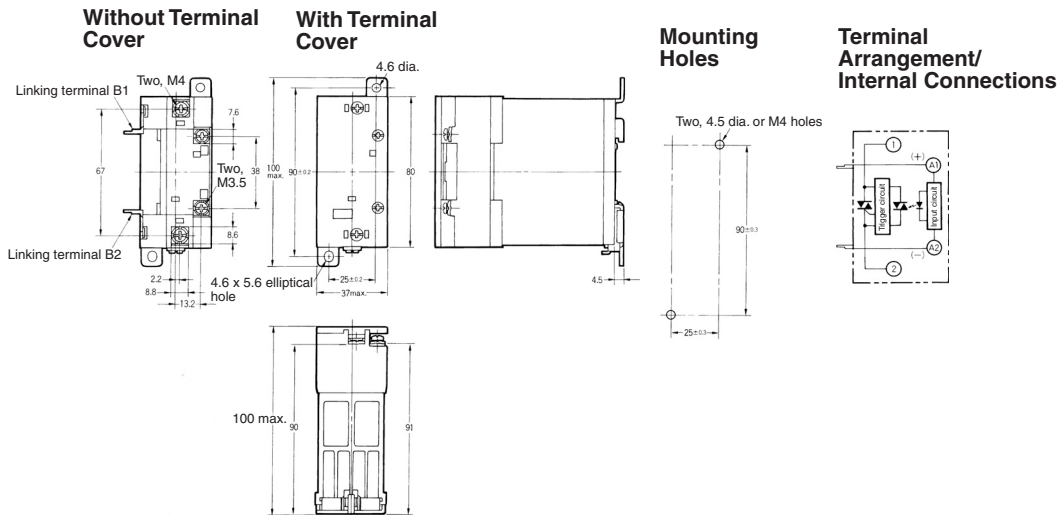
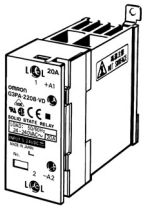

## G3PA-240B(L)-VD

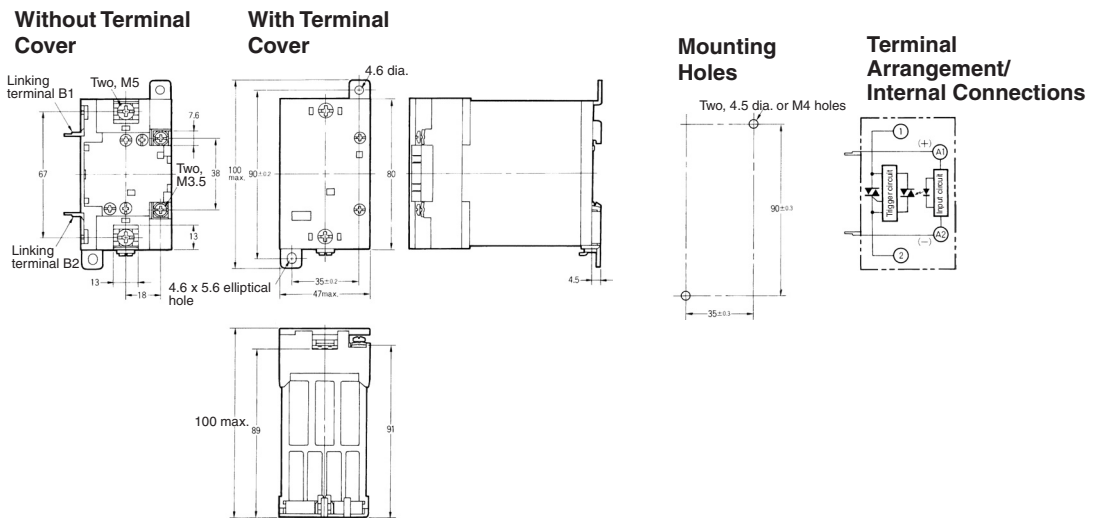
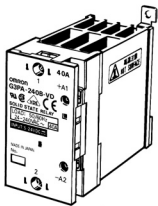

**G3PA-260B(L)-VD  
G3PA-450B-VD-2**

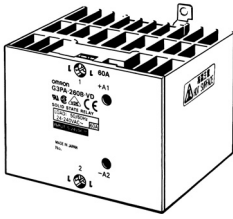

**With Terminal Cover**

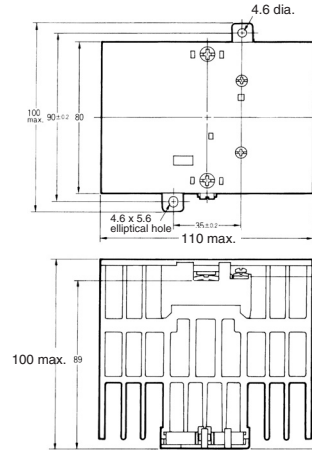

**Without Terminal Cover**

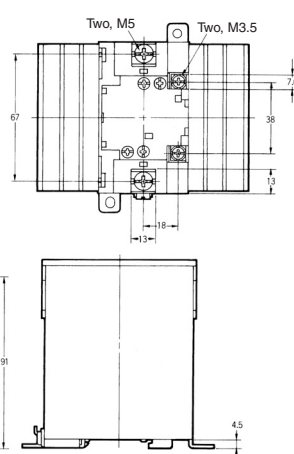

**Mounting Holes**

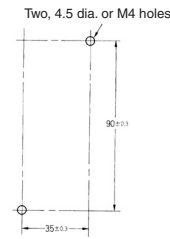

**Terminal Arrangement/  
Internal Connections**

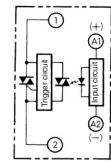

**G3PA-420B-VD, G3PA-420B-VD-2**

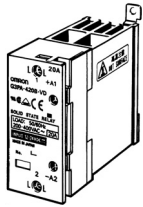

**Without Terminal Cover**

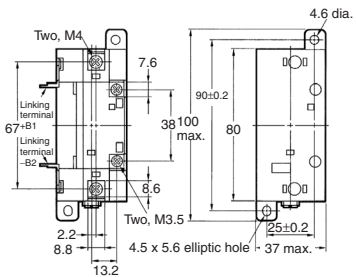

**With Terminal Cover**

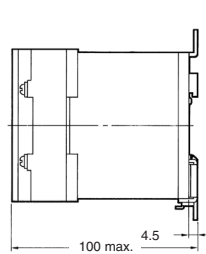

**Mounting Holes**

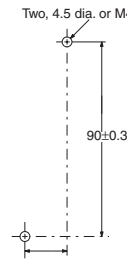

**Terminal Arrangement/  
Internal Connections**

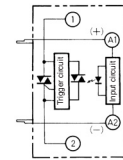

**G3PA-430B-VD, G3PA-430B-VD-2**

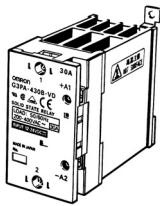

**Without Terminal Cover**

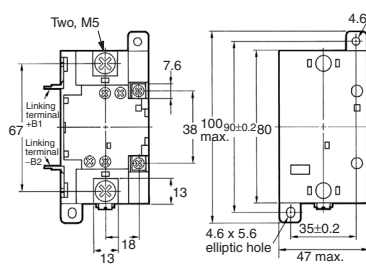

**With Terminal Cover**

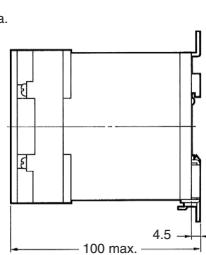

**Mounting Holes**

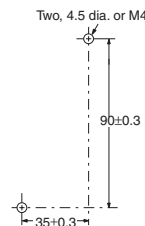

**Terminal Arrangement/  
Internal Connections**

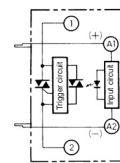

SSR

# Safety Precautions

## ■ Precautions for Correct Use

Please observe the following precautions to prevent failure to operate, malfunction, or undesirable effect on product performance.

### Load Connection

For an AC load, use a power supply rated at 50 or 60 Hz. The maximum operating frequency is 10 Hz. The G3PA-(VD) has a built-in varistor for overvoltage protection.

At a low applied voltage, such as 24 VAC, the load current is not fully supplied. When the Unit is switched ON, the voltage required to power the Unit deprives the output signal of the necessary voltage level and thus creates loss time. The lower the load voltage is, the greater the loss time is. This condition, however, will not create any serious problems.

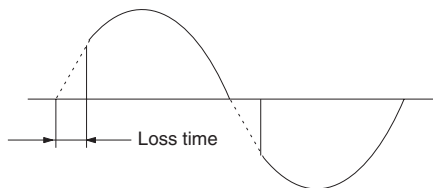

For a DC or L load, a diode should be connected in parallel the load to absorb the counter electromotive force of the load.

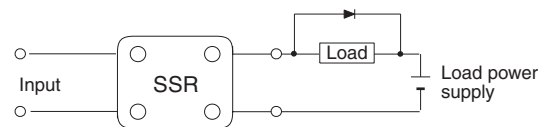

When attaching a heat sink to the G3PA-(VD), in order to facilitate heat dissipation, apply silicone grease or equivalent heat-conductive grease on the heat sink. (Toshiba Silicone, Shinetsu Silicone, etc.)

Tighten the mounting screws of the heat sink with a torque of 0.78 to 0.98 N·m.

### Noise Terminal Voltage according to EN55011

The G3PA-(VD) complies with EN55011 standards when a capacitor is connected to the load power supply as shown in the following circuit diagram.

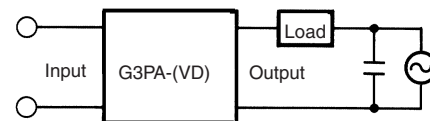

Recommended Capacitor: 1  $\mu$ F, 250 VAC

## Mounting

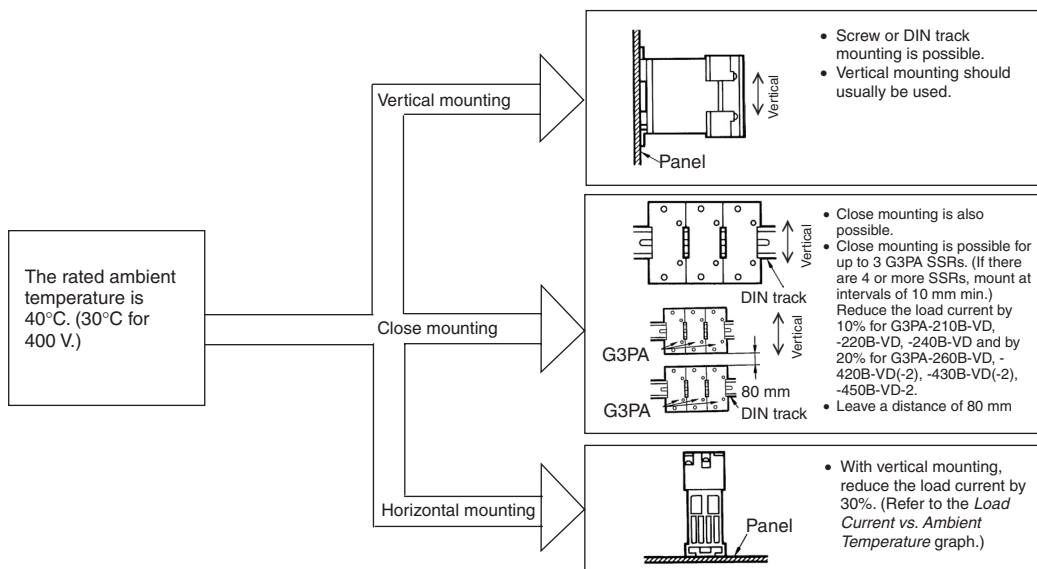

**Note:** Leave a distance of 60 mm min. between SSRs and ducts (especially above the SSR).

## Close Mounting

### SSR Mounting Pitch

**Panel Mounting** (At a rated ambient temperature of 40°C).

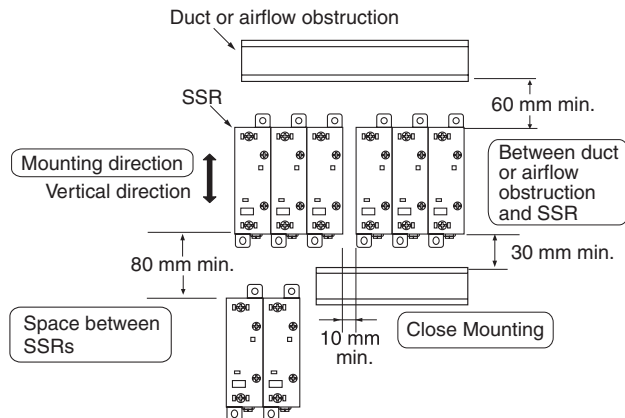

An SSR uses a semiconductor in the output element. This causes the temperature inside the control panel to increase due to heating resulting from the passage of electrical current through the load. To restrict heating, attach a fan to the ventilation outlet or air inlet of the control panel to ventilate the panel. This will reduce the ambient temperature of the SSRs and thus increase reliability. (Generally, each 10 °C reduction in temperature will double the expected life.)

Load current (A)	10 A	20 A	30 A	40 A	60 A
Required number of fans per SSR	0.16	0.31	0.47	0.62	0.93

Example: For 10 SSRs with load currents of 20 A,  
 $0.31 \times 10 = 3.1$   
 Thus, 4 fans would be required.

Size of fans: 92 mm<sup>2</sup>, Air volume: 0.7 m<sup>3</sup>/min,  
 Ambient temperature of control panel: 30 °C

**If there are other instruments that generate heat in the control panel other than SSRs, additional ventilation will be required.**

### Relationship between SSRs and Ducts

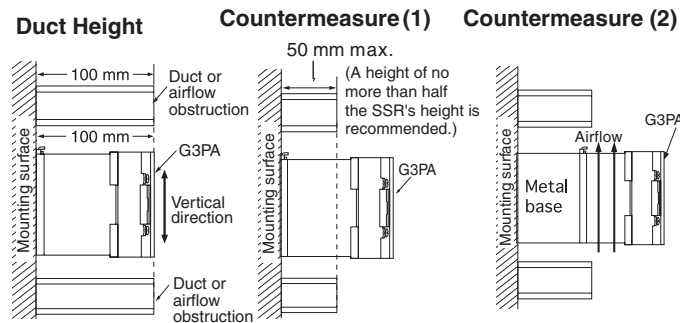

Do not surround the SSR with ducts, otherwise the heat radiation of the SSR will be adversely affected.

Use short ducts.

If the ducts cannot be shortened, place the SSR on a metal base so that it is not surrounded by the ducts.

### Ventilation

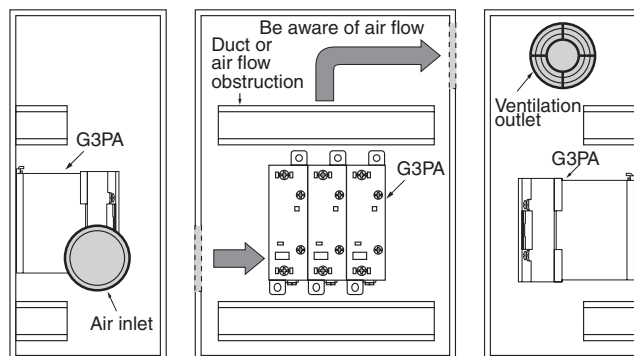

If the air inlet or air outlet has a filter, clean the filter regularly to prevent it from clogging and ensure an efficient flow of air.

Do not locate any objects around the air inlet or air outlet, otherwise the objects may obstruct the proper ventilation of the control panel.

A heat exchanger, if used, should be located in front of the SSR Units to ensure the efficiency of the heat exchanger.

**Please reduce the ambient temperature of SSRs.**

**The rated load current of an SSR is measured at an ambient temperature of 25 or 40 °C.**

SSR

ALL DIMENSIONS SHOWN ARE IN MILLIMETERS.

To convert millimeters into inches, multiply by 0.03937. To convert grams into ounces, multiply by 0.03527.

Cat. No. K094-E1-06

In the interest of product improvement, specifications are subject to change without notice.