

Digital DC/DC PMBus 25A Module

ISL8270M

The ISL8270M is a 25A step-down DC/DC power supply module with integrated digital PWM controller, synchronous power switches, an inductor and passives. Only bulk input and output capacitors are needed to finish the design. The 25A of continuous output current can be delivered without a need of airflow or a heatsink. The thermally enhanced HDA module is capable of dissipating heat directly into the PCB.

The ISL8270M uses ChargeMode™ control architecture, which responds to a transient load within a single switching cycle. The ISL8270M comes with a preprogrammed configuration for operating in a pin strap mode; output voltage, switching frequency, and device SMBus address can be programmed with external resistors. More configuration such as soft-start and fault limits can be easily programmed or changed via PMBus compliant serial bus interface. PMBus can be used to monitor voltages, current, temperatures and fault status. The ISL8270M is supported by PowerNavigator™ software, a graphical user interface (GUI) that can be used to configure modules to a desired solution.

The ISL8270M is available in a 40-pin compact 17mmx19mm HDA module with very low profile height 3.55mm, suitable for automated assembly by standard surface mount equipment. The ISL8270M is RoHS compliant by exemption.

Features

- Complete digital switch mode power supply
 - Wide V_{IN} range: 4.5V to 14V
 - Programmable V_{OUT} range: 0.6V to 5V
- PMBus compliant I²C communication interface
 - Programmable V_{OUT} , margining, UV/OV, I_{OUT} limit, soft-start/stop, sequencing, and external synchronization
 - Monitor: V_{IN} , V_{OUT} , I_{OUT} , temperature, duty cycle, switching frequency and faults
- ChargeMode control architecture
- $\pm 1.0\%$ V_{OUT} accuracy over line, load and temperature
- Power-Good indicator
- Over-temperature protection
- Internal non-volatile memory and fault logging
- Patented thermally enhanced HDA package

Applications

- Server, telecom, storage, and datacom
- Industrial/ATE, and networking equipment
- General purpose power for ASIC, FPGA, DSP and memory

Related Literature

- [AN1926](#) "ISL8270MEVAL1Z Evaluation Board User Guide"

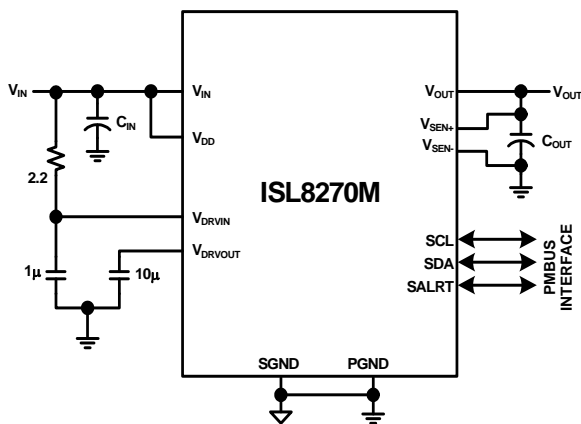

NOTE:

1. Only bulk input and output capacitors are required to finish the design.

FIGURE 1. A COMPLETE DIGITAL SWITCH MODE POWER SUPPLY

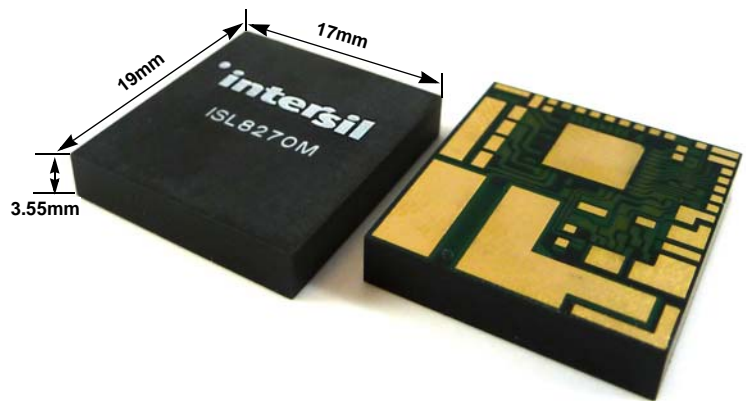

FIGURE 2. A SMALL PACKAGE FOR HIGH POWER DENSITY

Table of Contents

Ordering Information	3
Firmware Revision History	3
Pin Configuration	4
Pin Descriptions	4
ISL8270M Internal Block Diagram	6
Absolute Maximum Ratings	7
Thermal Information	7
Recommended Operating Conditions	7
Electrical Specifications	7
Typical Performance Curves	10
Efficiency Performance	10
Transient Response Performance	11
Derating Curves	12
Derating Curves	13
Typical Application Circuit	14
Functional Description	16
SMBus Communications	16
Output Voltage Selection	16
Soft-start Delay and Ramp Times	16
Power-Good	16
Switching Frequency and PLL	16
Loop Compensation	17
Input Undervoltage Lockout (UVLO)	17
SMBus Module Address Selection	17
Output Overvoltage Protection	18
Output Pre-Bias Protection	18
Output Overcurrent Protection	18
Thermal Overload Protection	18
Digital-DC Bus	19
Phase Spreading	19
Output Sequencing	19
Fault Spreading	19
Temperature Monitoring Using XTEMP Pin	19
Monitoring Via SMBus	19
Snapshot Parameter Capture	19
Non-Volatile Memory	20
PCB Layout Guidelines	20
Thermal Considerations	21
Package Description	21
PCB Layout Pattern Design	21
Thermal Vias	21
Stencil Pattern Design	21
Reflow Parameters	21
PMBus Command Summary	22
PMBus™ Data Formats	25
PMBus Commands Description	26
Revision History	46
About Intersil	46
Package Outline Drawing	47

ISL8270M

Ordering Information

PART NUMBER (Notes 2, 3, 4)	PART MARKING	TEMP RANGE (°C)	PACKAGE (Pb-Free)	PKG. DWG. #
ISL8270MAIRZ	ISL8270M	-40 to +85	40 Ld 17x19 HDA	Y40.17x19
ISL8270MEVAL1Z	Evaluation Board			

NOTES:

- Add "-T*" suffix for tape and reel. Please refer to [TB347](#) for details on reel specifications.
- These Intersil Pb-free plastic packaged products are RoHS compliant by EU exemption 7C-I and employ special Pb-free material sets; molding compounds/die attach materials and NiPdAu plate - e4 termination finish which is compatible with both SnPb and Pb-free soldering operations. Intersil Pb-free products are MSL classified at Pb-free peak reflow temperatures that meet or exceed the Pb-free requirements of IPC/JEDEC J STD-020.
- For Moisture Sensitivity Level (MSL), please see product information page for [ISL8270M](#). For more information on MSL, please see tech brief [TB363](#).

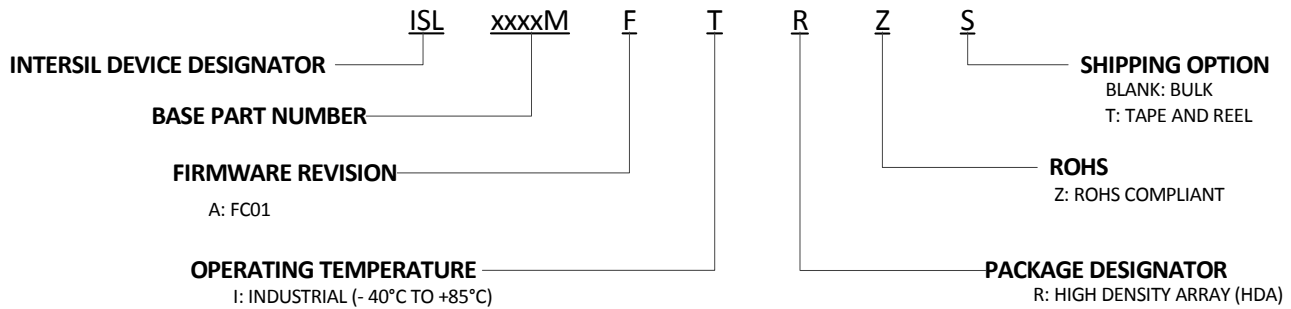

Firmware Revision History

TABLE 1. ISL8270M NOMENCLATURE GUIDE

FIRMWARE REVISION CODE	CHANGE DESCRIPTION	NOTE
ISL8270-000-FC01	Initial Release	

ISL8270M

Pin Configuration

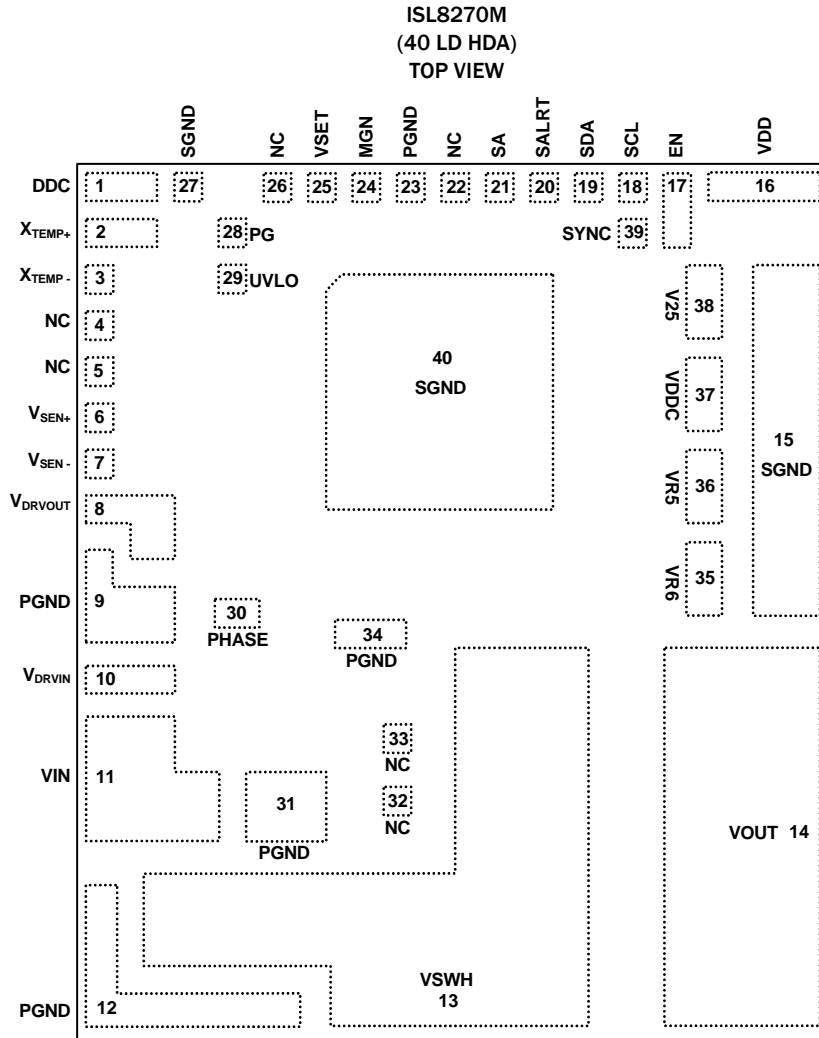

Pin Descriptions

PIN	LABEL	TYPE	DESCRIPTION
1	DDC	I/O	A Digital-DC™ bus. This dedicated bus provides the communication channel between devices for features such as sequencing and fault spreading. The DDC pin on all Digital-DC devices should be connected together. A pull-up resistor is required for this application.
2	XTEMP+	I	Differential external temperature sensor positive input pin.
3	XTEMP-	I	Differential external temperature sensor negative input pin.
6	VSEN+	I	Differential Output voltage sense feedback. Connect to positive output regulation point.
7	VSEN-	I	Differential Output voltage sense feedback. Connect to negative output regulation point.
8	VDRVOUT	PWR	Output of internal LDO for powering internal gate driver block. Place a 10µF ceramic capacitor at this pin. LDO output is dedicated to powering internal gate driver stage only. Do not use this LDO for any other purpose.
9, 12, 23, 31, 34	PGND	PWR	Power ground. Refer to the “PCB Layout Guidelines” on page 20 for the PGND pad connections and decoupling capacitors placement.
10	VDRVIN	PWR	Input supply to internal LDO for powering internal gate driver block. A RC filter is required if VIN supply is shared. Refer to the “PCB Layout Guidelines” on page 20.
11	VIN	PWR	Main input supply. Refer to the “PCB Layout Guidelines” on page 20 for the decoupling capacitors placement from VIN to PGND.

ISL8270M

Pin Descriptions (Continued)

PIN	LABEL	TYPE	DESCRIPTION
13	VSWH	PWR	Switch node. Refer to the "PCB Layout Guidelines" on page 20 for connecting VSWH pads to electrically isolated PCB copper island to dissipate internal heat.
14	VOUT	PWR	Power supply output. Range: 0.6V to 5V. Refer to Derating Curves on pages 12 for maximum recommended output current at various output voltages.
15, 27, 40	SGND	PWR	Controller Signal ground. Refer to the "PCB Layout Guidelines" on page 20 for the SGND pad connections.
16	VDD	PWR	Input supply to digital controller. Connect VDD pad to VIN supply. Refer to the "PCB Layout Guidelines" on page 20 for the decoupling capacitors placement from VDD to SGND.
17	EN	I	External enable input. Logic high enables the module.
18	SCL	I	Serial clock input. A pull-up resistor is required for this application.
19	SDA	I/O	Serial data. A pull-up resistor is required for this application.
20	SALRT	O	Serial alert. A pull-up resistor is required for this application.
21	SA	I	Serial bus address select pin. Refer to Table 7 for list of resistor values to set various serial bus address.
24	MGN	I	External VOUT margin control pin. Active high (>2V) signal at this pin sets V _{OUT} margin high, Active low (<0.8V) sets VOUT margin low and high impedance (float) will bring V _{OUT} back to nominal voltage. Factory default range for margining is nominal V _{OUT} ±5%. When using PMBus to control margin command, leave this pin as no connect.
25	VSET	I	Output voltage selection pin. Refer to Table 4 for list of resistor values to set various output voltages.
28	PG	O	Power-Good output. Power-Good output can be open drain that requires pull-up resistor or push-pull output that can drive a logic input.
29	UVLO	I	VDD undervoltage lockout selection. Refer to Table 6 for list of resistors value to set various UVLO levels.
30	PHASE	PWR	Switch node pad for DCR sensing. Electrically shorted inside to VSWH but for higher current sensing accuracy connect PHASE pad to VSWH pad externally. Refer to the "PCB Layout Guidelines" on page 20.
35	VR6	PWR	6V Internal reference supply voltage.
36	VR5	PWR	5V Internal reference supply voltage.
37	VDDC	PWR	VDD Clean. Noise at the VDD pin is filtered with ferrite bead and capacitor. For VDD > 6V, leave this pin as no connect. For 5.5 ≤ VDD ≤ 6V, connect VDDC pin to VR6 pin. For 4.5 ≤ VDD < 5.5V, connect VDDC pin to VR6 and VR5 pin.
38	V25	PWR	2.5V Internal reference supply voltage.
39	SYNC	I/O	SYNC pin can be input to external clock for frequency synchronization or output to supply clock signal to other modules for synchronization. Refer to Table 5 for list of resistor values to program various switching frequencies.
4, 5, 22, 26, 32, 33	NC		These are test pins and are not electrically isolated. Leave these pins as no connect.

ISL8270M Internal Block Diagram

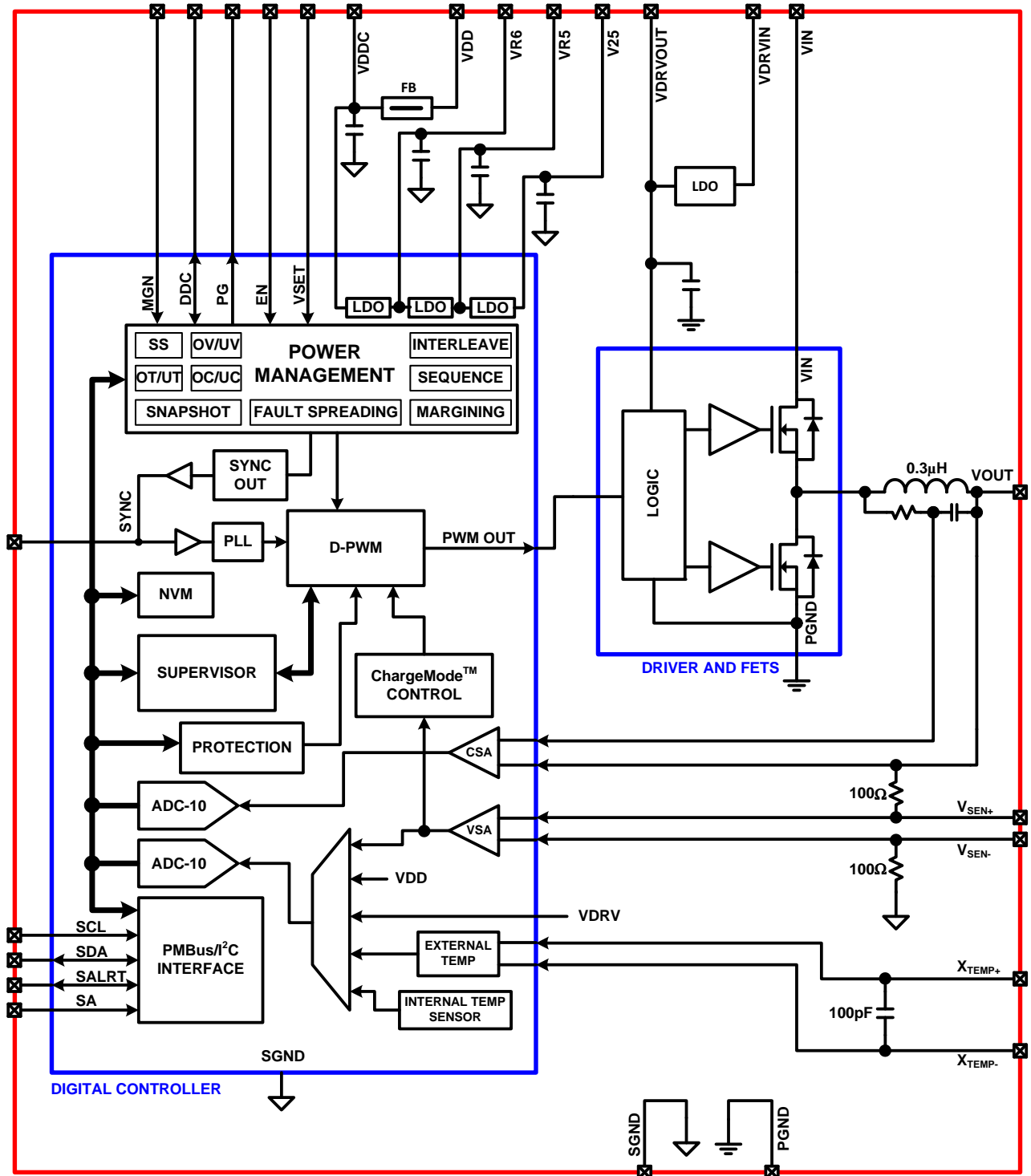

ISL8270M

Absolute Maximum Ratings

Input Supply Voltage, VIN Pin	-0.3V to 17V
Input Supply Voltage for Controller, VDD Pin	-0.3V to 17V
Input Gate Driver Supply Voltage, VDRVIN Pin	-0.3V to 17V
Output Gate Driver Supply Voltage, VDRVOUT Pin	-0.3V to 6V
6V Internal Reference Supply Voltage, VR6 Pin	-0.3V to 6.6V
5V Internal Reference Supply Voltage, VR5 Pin	-0.3V to 6.5V
2.5V Internal Reference Supply Voltage, V25 Pin	-0.3V to 3V
Logic I/O Voltage for DDC, EN, MGN, PG, DISB#	
SA, SCL, SDA, SALRT, SYNC, UVLO, VMON, VSET	-0.3V to 6.0V
Analog Input Voltages for	
VSEN+, XTEMP+	-0.3V to 6.0V
VSEN-, XTEMP-	-0.3V to 0.3V
ESD Rating	
Human Body Model (Tested per JESD22-A114F)	2000V
Machine Model (Tested per JESD22-A115C)	200V
Charged Device Model (Tested per JESD22-C110D)	750V
Latch Up (Tested per JESD78C; Class 2, Level A)	100mA

Thermal Information

Thermal Resistance (Typical)	θ_{JA} (°C/W)	θ_{JC} (°C/W)
40 LD HDA Package (Notes 5, 6)	7.5	2.2
Maximum Junction Temperature (Plastic Package)	+125°C	
Storage Temperature Range	-55°C to +150°C	
Pb-Free Reflow Profile	see link below	
	http://www.intersil.com/pbfree/Pb-FreeReflow.asp	

Recommended Operating Conditions

Input Supply Voltage Range, VIN	4.5V to 14V
Input Supply Voltage Range for Controller, VDD	4.5V to 14V
Output Voltage Range, VOUT	0.6V to 5V
Output Current Range, IOUT(DC) (Note 9)	0A to 25A
Operating Junction Temperature Range, TJ	-40°C to +125°C

CAUTION: Do not operate at or near the maximum ratings listed for extended periods of time. Exposure to such conditions may adversely impact product reliability and result in failures not covered by warranty.

NOTES:

- θ_{JA} is measured in free air with the module mounted on an evaluation board 3x4.5inch in size with 2oz surface and 2oz buried planes and multiple via interconnects as specified on [AN1926](#), "ISL8270MEVAL1Z Evaluation Board User Guide".
- For θ_{JC} , the "case temp" location is the center of the package underside.

Electrical Specifications $V_{IN} = V_{DD} = 12V$, $F_{SW} = 533kHz$, $C_{OUT} = 1340\mu F$, $T_A = -40^\circ C$ to $+85^\circ C$, unless otherwise noted. Typical values are at $T_A = +25^\circ C$. **Boldface limits apply across the operating temperature range, $-40^\circ C$ to $+85^\circ C$.**

SYMBOL	PARAMETER	TEST CONDITIONS	MIN (Note 7)	TYP	MAX (Note 7)	UNITS
INPUT AND SUPPLY CHARACTERISTICS						
I _{DD}	Input Supply Current for Controller	V _{IN} = V _{DD} = 12V, V _{OUT} = 0V, Module not Enabled		40	50	mA
V _{R6}	6V Internal Reference Supply Voltage		5.5	6.1	6.6	V
V _{R5}	5V Internal Reference Supply Voltage	I _{VR5} < 5mA	4.5	5.2	5.5	V
V ₂₅	2.5V Internal Reference Supply Voltage		2.25	2.5	2.75	V
V _{DD_READ_RES}	Input Supply Voltage for Controller Read Back Resolution			10		Bits
V _{DD_READ_ERR}	Input Supply Voltage for Controller Read Back Total Error (Note 10)	PMBus Read		±2		%FS
OUTPUT CHARACTERISTICS						
V _{OUT_RANGE}	Output Voltage Adjustment Range	V _{IN} > V _{OUT} + 1.8V	0.54		5.5	V
V _{OUT_RES}	Output Voltage Set-Point Range	Configured using PMBus		±0.025		%
V _{OUT_ACCY}	Output Voltage Set-Point Accuracy (Notes 8, 10)	Includes Line, Load and Temperature (-20°C ≤ T _A ≤ +85°C)	-1		+1	% FS
V _{OUT_READ_RES}	Output Voltage Read back Resolution			10		Bits
V _{OUT_READ_ERR}	Output Voltage Read back Total Error (Note 10)	PMBus Read	-2		+2	%FS
I _{OUT_READ_RES}	Output Current Read back Resolution			10		Bits
I _{OUT_RANGE}	Output Current Range (Note 9)				25	A
I _{OUT_READ_ERR}	Output Current Read back Total Error	PMBus Read at Max Load		±2		A

ISL8270M

Electrical Specifications $V_{IN} = V_{DD} = 12V$, $F_{SW} = 533kHz$, $C_{OUT} = 1340\mu F$, $T_A = -40^\circ C$ to $+85^\circ C$, unless otherwise noted. Typical values are at $T_A = +25^\circ C$. **Boldface limits apply across the operating temperature range, $-40^\circ C$ to $+85^\circ C$.** (Continued)

SYMBOL	PARAMETER	TEST CONDITIONS	MIN (Note 7)	TYP	MAX (Note 7)	UNITS
SOFT-START AND SEQUENCING						
t_{ON_DELAY}	Delay Time From Enable to V_{OUT} Rise	Configured Using PMBus	2		5000	ms
$t_{ON_DELAY_ACCY}$	t_{ON_DELAY} Accuracy			± 2		ms
t_{ON_RISE}	Output Voltage Ramp-Up Time	Configured Using PMBus	0.5		100	ms
$t_{ON_RISE_ACCY}$	Output Voltage Ramp-Up Time Accuracy			± 250		μs
t_{OFF_DELAY}	Delay Time From disable to V_{OUT} Fall	Configured Using PMBus	2		5000	ms
$t_{OFF_DELAY_ACCY}$	t_{OFF_DELAY} Accuracy			± 2		ms
t_{OFF_FALL}	Output Voltage Fall Time	Configured Using PMBus	0.5		100	ms
$t_{ON_FALL_ACCY}$	Output Voltage Fall Time Accuracy			± 250		μs
POWER-GOOD						
V_{PG_DELAY}	Power-Good Delay	Configured Using PMBus	0		5000	ms
TEMPERATURE SENSE						
T_{SENSE_RANGE}	Temperature Sense Range	Configurable VIA PMBus	-50		150	$^\circ C$
INT_TEMP_ACCY	Internal Temperature Sensor Accuracy	Tested at $+100^\circ C$	-5		+5	$^\circ C$
$XTEMP_ACCY$	External Temperature Sensor Accuracy	Using 2N3904 NPN Transistor		± 5		$^\circ C$
FAULT PROTECTION						
$V_{DD_UVLO_RANGE}$	V_{DD} Undervoltage Threshold Range	Measured Internally	4.18		16	V
$V_{DD_UVLO_ACCY}$	V_{DD} Undervoltage Threshold Accuracy (Note 10)			± 2		%FS
$V_{DD_UVLO_DELAY}$	V_{DD} Undervoltage Response Time			10		μs
$V_{OUT_OV_RANGE}$	V_{OUT} Overvoltage Threshold Range	Factory Default		$V_{OUT}+15$		%
		Configured using PMBus	$V_{OUT}+5$		V_{OUT_MAX}	%
$V_{OUT_UV_RANGE}$	V_{OUT} Undervoltage Threshold Range	Factory Default		$V_{OUT}-15$		%
		Configured using PMBus	0		$V_{OUT}-5$	%
V_{OUT_OV/UV_ACCY}	V_{OUT} OV/UV Threshold Accuracy (Note 8)		-2		+2	%
V_{OUT_OV/UV_DELAY}	V_{OUT} OV/UV Response Time			10		μs
I_{LIMIT_ACCY}	Output Current Limit Set-Point Accuracy (Note 10)	Tested at $I_{OUT_OC_FAULT_LIMIT} = 30A$		± 10		%FS
I_{LIMIT_DELAY}	Output Current Fault Response Time (Note 11)	Factory Default		5		t_{SW}
$T_{JUNCTION}$	Over-temperature Protection Threshold (Controller Junction Temperature)	Factory Default		125		$^\circ C$
		Configured using PMBus	-40		125	$^\circ C$
$T_{JUNCTION_HYS}$	Thermal Protection Hysteresis			15		$^\circ C$

ISL8270M

Electrical Specifications $V_{IN} = V_{DD} = 12V$, $F_{SW} = 533kHz$, $C_{OUT} = 1340\mu F$, $T_A = -40^\circ C$ to $+85^\circ C$, unless otherwise noted. Typical values are at $T_A = +25^\circ C$. **Boldface limits apply across the operating temperature range, $-40^\circ C$ to $+85^\circ C$.** (Continued)

SYMBOL	PARAMETER	TEST CONDITIONS	MIN (Note 7)	TYP	MAX (Note 7)	UNITS
OSCILLATOR AND SWITCHING CHARACTERISTICS						
F_{SW_RANGE}	Switching Frequency Range		296		1067	kHz
F_{SW_ACCY}	Switching Frequency Set-Point Accuracy		-5		+5	%
EXT_SYNC_{PW}	Minimum Pulse Width Required from External SYNC Clock	Measured at 50% Amplitude	150			ns
EXT_SYNC_{DRIFT}	Drift Tolerance for External SYNC Clock	External SYNC Clock equal to 500kHz is not supported	-10		+10	%
LOGIC INPUT/OUTPUT CHARACTERISTICS						
I_{LOGIC_BIAS}	Bias Current at the Logic Input Pins	DDC, EN, MGN, PG, SA, SCL, SDA, SALRT, SYNC, UVLO, V_{MON} , V_{SET}	-100		+100	nA
$V_{LOGIC_IN_LOW}$	Logic Input Low Threshold Voltage				0.8	V
$V_{LOGIC_IN_HIGH}$	Logic Input High Threshold Voltage		2.0			V
$V_{LOGIC_OUT_LOW}$	Logic Output Low Threshold Voltage	2mA sinking			0.5	V
$V_{LOGIC_OUT_HIGH}$	Logic Output High Threshold Voltage	2mA sourcing	2.25			V
PMBus INTERFACE TIMING CHARACTERISTIC						
F_{SMB}	PMBus Operating Frequency		100		400	kHz

NOTES:

7. Compliance to datasheet limits is assured by one or more methods: Production test, characterization and/or design.
8. V_{OUT} measured at the termination of the V_{SEN+} and V_{SEN-} sense points.
9. The MAX load current is determined by the thermal "Derating Curves" on page 12, provide with this document.
10. "FS" stand for full scale of recommended maximum operation range.
11. " t_{SW} " stands for time period of operation switching frequency.

Typical Performance Curves

Efficiency Performance Operating condition: $T_A = +25^\circ\text{C}$, No air flow. $C_{OUT} = 1340\mu\text{F}$. Typical values are used unless otherwise noted.

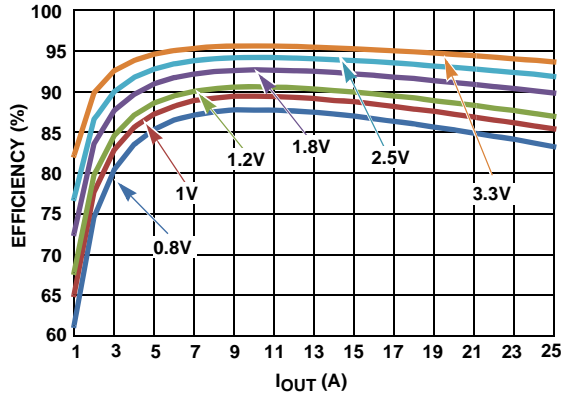

FIGURE 3. EFFICIENCY vs OUTPUT CURRENT AT $V_{IN} = 5\text{V}$, $F_{SW} = 550\text{kHz}$ FOR VARIOUS OUTPUT VOLTAGES

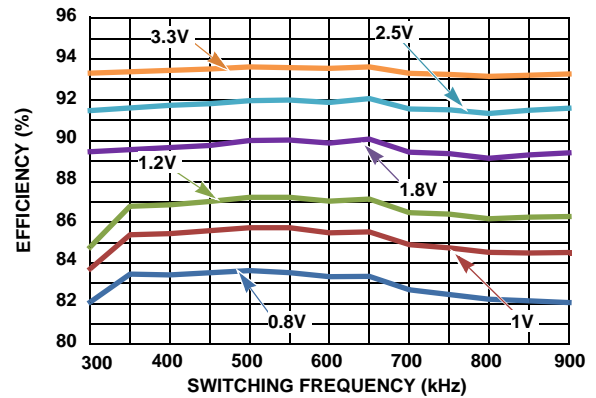

FIGURE 4. EFFICIENCY vs SWITCHING FREQUENCY AT $V_{IN} = 5\text{V}$, $I_{OUT} = 25\text{A}$ FOR VARIOUS OUTPUT VOLTAGES

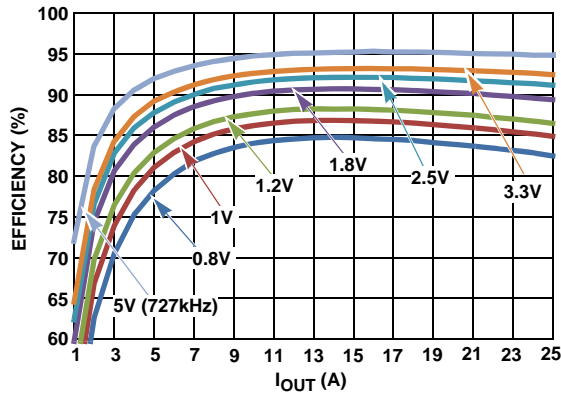

FIGURE 5. EFFICIENCY vs OUTPUT CURRENT AT $V_{IN} = 9\text{V}$, $F_{SW} = 550\text{kHz}$ FOR VARIOUS OUTPUT VOLTAGES

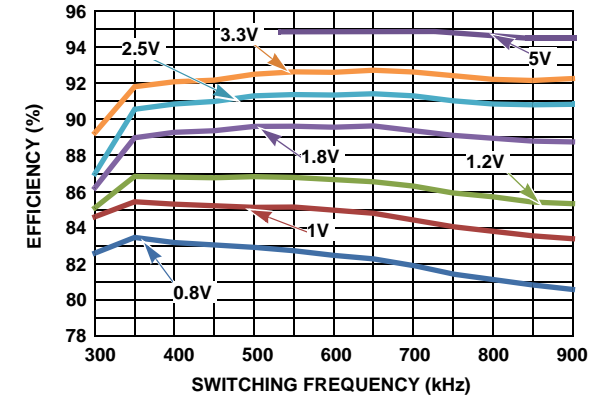

FIGURE 6. EFFICIENCY vs SWITCHING FREQUENCY AT $V_{IN} = 9\text{V}$, $I_{OUT} = 25\text{A}$ FOR VARIOUS OUTPUT VOLTAGES

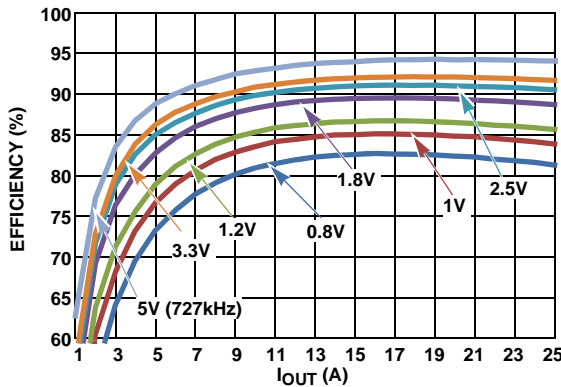

FIGURE 7. EFFICIENCY vs OUTPUT CURRENT AT $V_{IN} = 12\text{V}$, $F_{SW} = 550\text{kHz}$ FOR VARIOUS OUTPUT VOLTAGES

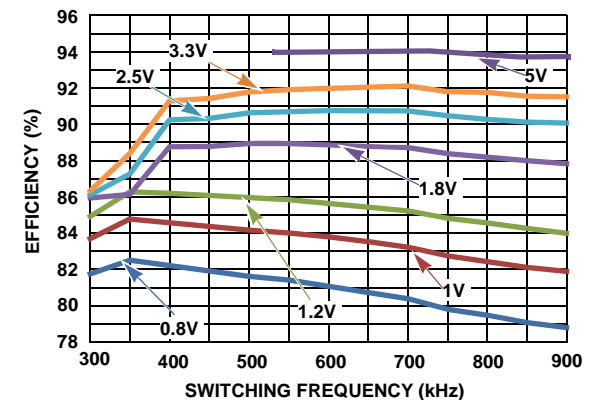

FIGURE 8. EFFICIENCY vs SWITCHING FREQUENCY AT $V_{IN} = 12\text{V}$, $I_{OUT} = 25\text{A}$ FOR VARIOUS OUTPUT VOLTAGES

Typical Performance Curves (Continued)

Transient Response Performance $V_{IN} = 12$, $C_{OUT} = 4 \times 100\mu\text{F}$ Ceramic and $2 \times 470\mu\text{F}$ POSCAP, $I_{OUT} = 0/12.5\text{A}$,
 I_{OUT} Slew rate = $12.5\text{A}/\mu\text{s}$, $T_A = +25^\circ\text{C}$, Typical values are used unless otherwise noted.

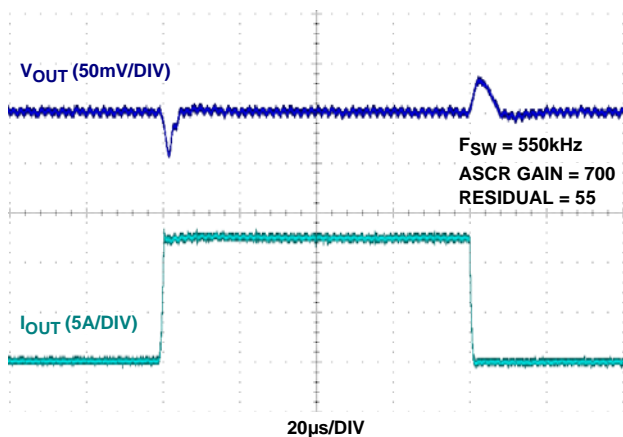

FIGURE 9. 0.8V TRANSIENT RESPONSE

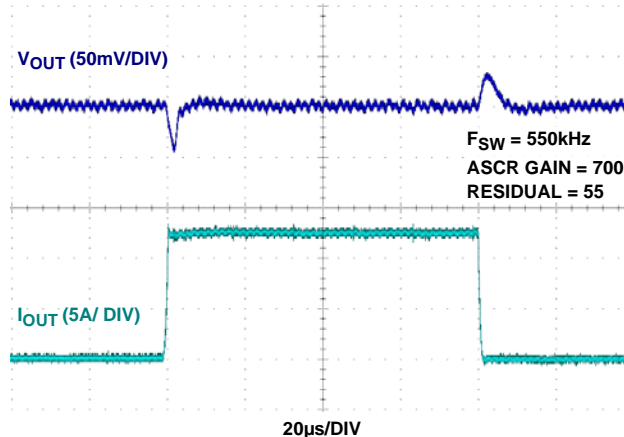

FIGURE 10. 1V TRANSIENT RESPONSE

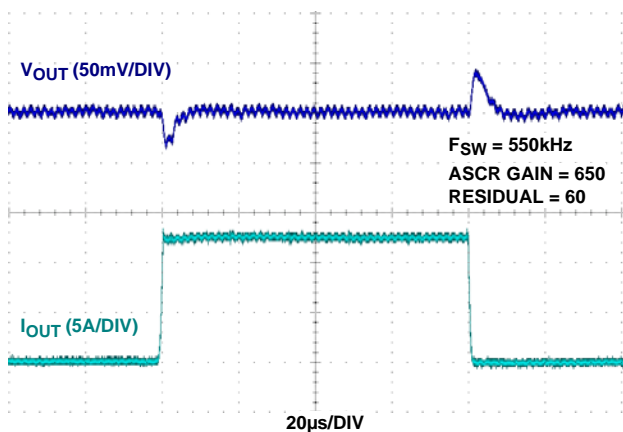

FIGURE 11. 1.2V TRANSIENT RESPONSE

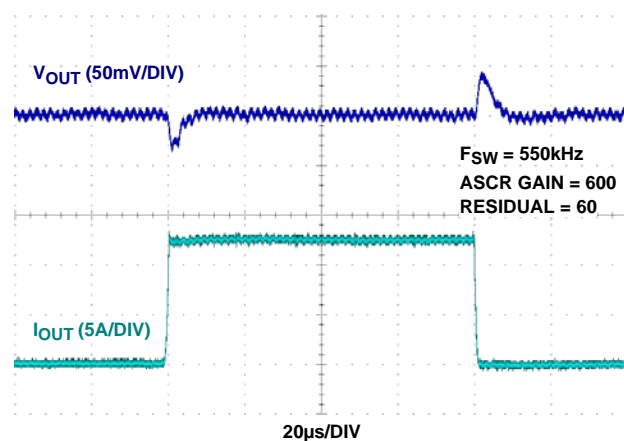

FIGURE 12. 1.8V TRANSIENT RESPONSE

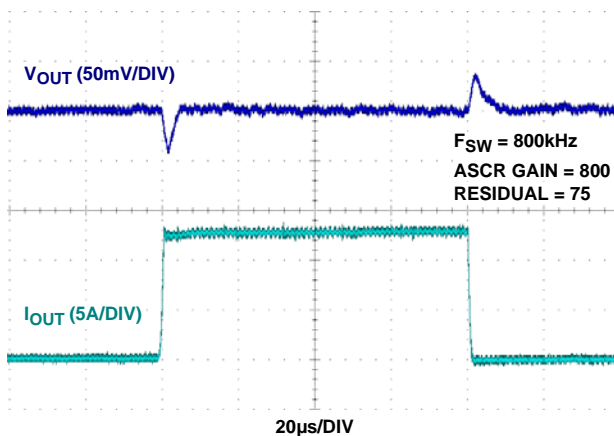

FIGURE 13. 2.5V TRANSIENT RESPONSE

Typical Performance Curves (Continued)

Derating Curves All of the following curves were plotted at $T_J = +115^\circ\text{C}$, $F_{SW} = 533\text{kHz}$

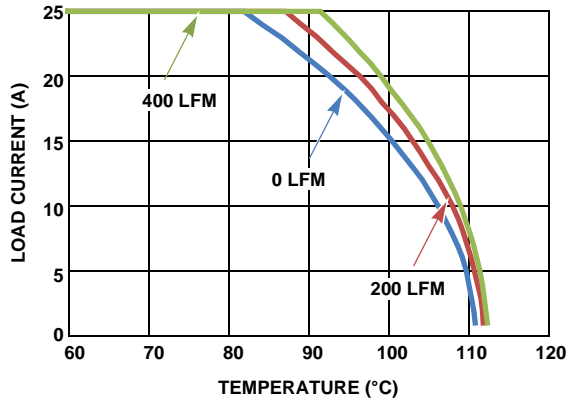

FIGURE 14. $5V_{IN}$ TO $1V_{OUT}$

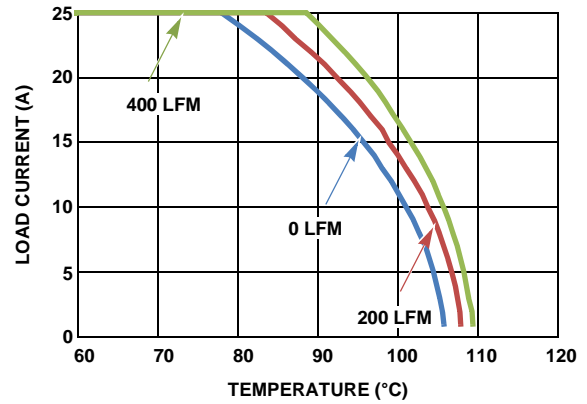

FIGURE 15. $12V_{IN}$ TO $1V_{OUT}$

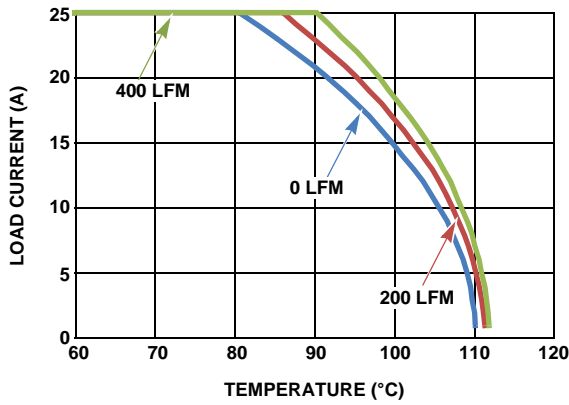

FIGURE 16. $5V_{IN}$ TO $1.2V_{OUT}$

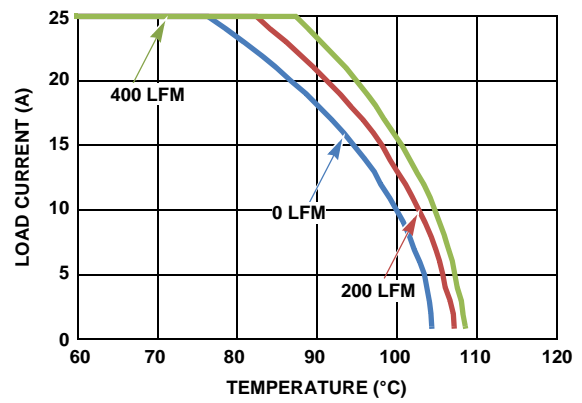

FIGURE 17. $12V_{IN}$ TO $1.2V_{OUT}$

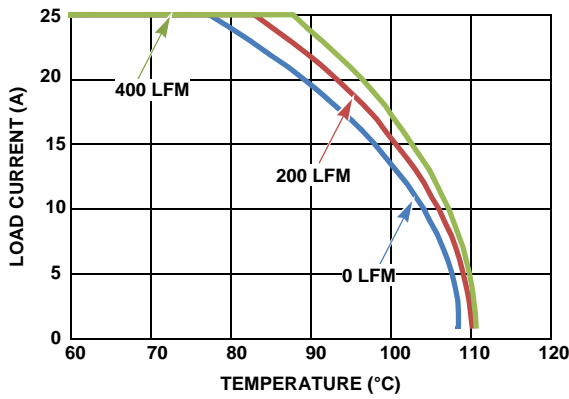

FIGURE 18. $5V_{IN}$ TO $1.8V_{OUT}$

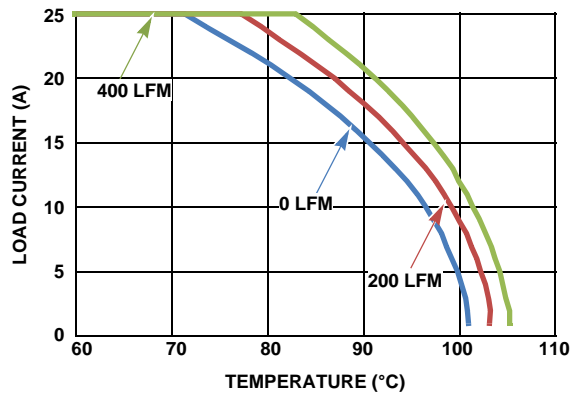

FIGURE 19. $12V_{IN}$ TO $1.8V_{OUT}$

Typical Performance Curves (Continued)

Derating Curves All of the following curves were plotted at $T_J = +115^\circ\text{C}$, $F_{SW} = 533\text{kHz}$ (Continued)

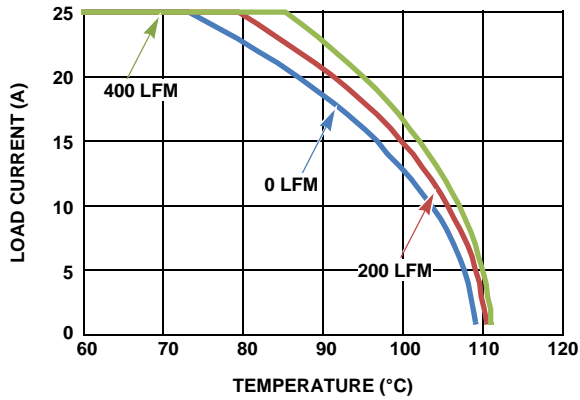

FIGURE 20. $5V_{IN}$ TO $2.5V_{OUT}$

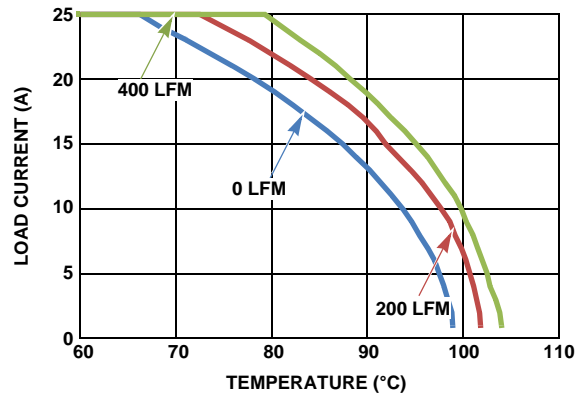

FIGURE 21. $12V_{IN}$ TO $2.5V_{OUT}$

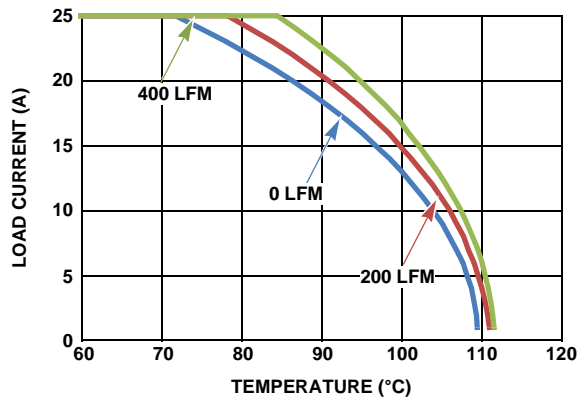

FIGURE 22. $5V_{IN}$ TO $3.3V_{OUT}$

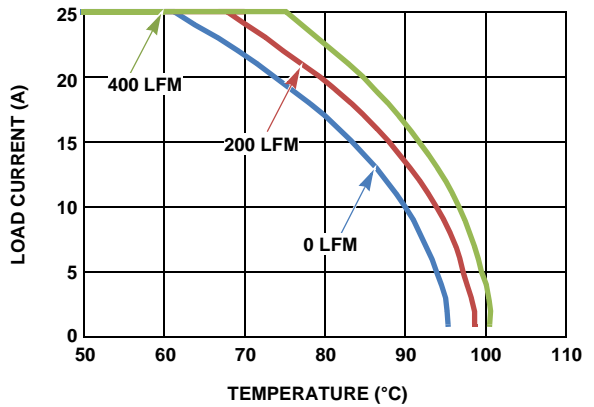

FIGURE 23. $12V_{IN}$ TO $3.3V_{OUT}$

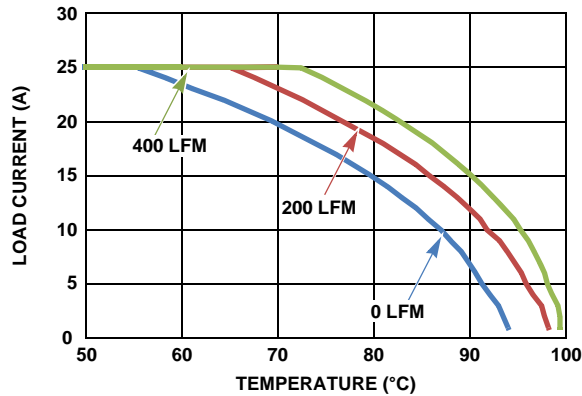
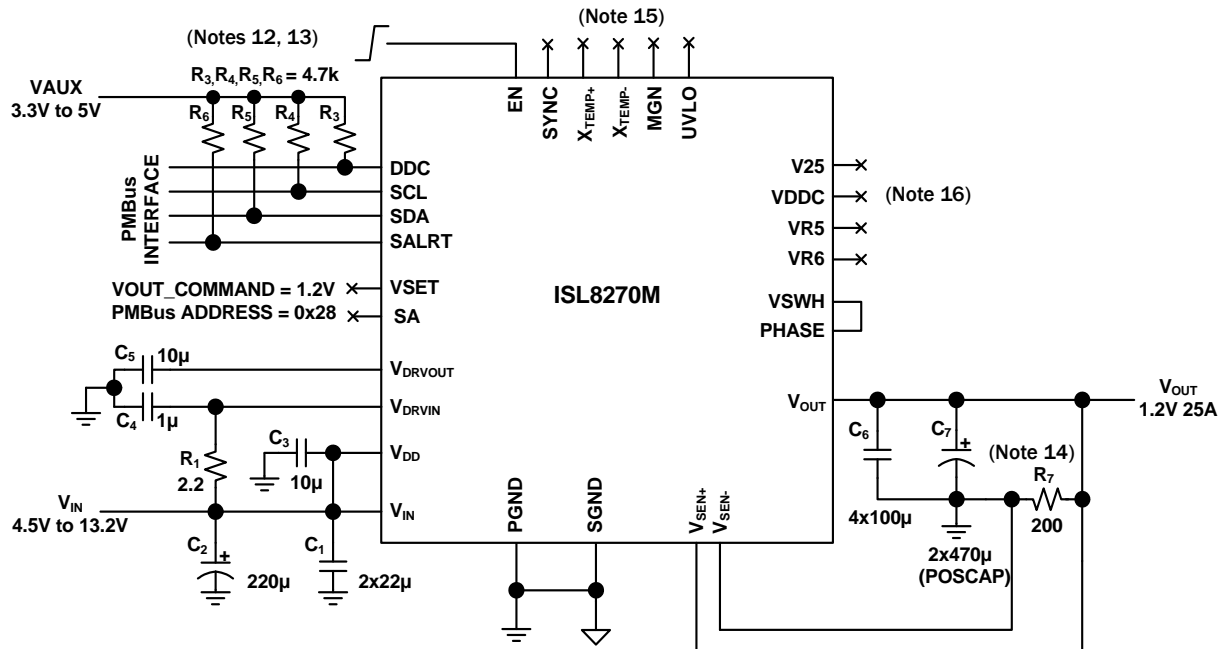

FIGURE 24. $12V_{IN}$ TO $5V_{OUT}$, 727kHz

Typical Application Circuit



NOTES:

12. R_4 and R_5 are not required if the PMBus host already has I²C pull-up resistors.
13. Only one R_3 per DDC bus is required when DDC bus is shared with other modules.
14. R_7 is optional but recommended to sink possible ~100μA back-flow current from the V_{SEN+} pin. Back-flow current is present only when the module is in a disabled state with power still available at the VDD pin.
15. Unused pins (SYNC, XTEMP, MGN, UVLO) can be no connect.
16. Internal reference supply pins (V25, VDDC, VR5, VR6) do not need external capacitors and can be no connect. Refer to "PCB Layout Guidelines" on page 20 for more information.

FIGURE 25. TYPICAL SINGLE PHASE APPLICATION CIRCUIT FOR 1.2V/25A OUTPUT

ISL8270M

TABLE 2. ISL8270M DESIGN GUIDE MATRIX AND OUTPUT VOLTAGE RESPONSE

V _{IN} (V)	V _{OUT} (V)	C _{IN} (BULK) (Note 17)	C _{IN} (CERAMIC)	C _{OUT} (BULK)	C _{OUT} (CERAMIC)	ASCR GAIN (Note18)	ASCR RESIDUAL (Note 18)	P-P DEVIATION (mV)	RECOVERY TIME (μs)	LOAD STEP (A) (Note19)	FREQ. (kHz)
5	1	2x150μF	4x47μF	2x470μF	6x100μF	380	90	45	14	12.5	516
12	1	2x150μF	3x22μF	3x470μF	6x100μF	230	80	50	18	12.5	348
12	1	2x150μF	2x22μF	2x470μF	6x100μF	400	90	48	12	12.5	516
5	1.8	2x150μF	5x47μF	2x470μF	3x100μF	250	70	65	12	12.5	516
12	1.8	2x150μF	3x22μF	2x470μF	3x100μF	250	70	65	12	12.5	516
5	2.5	2x150μF	5x47μF	1x470μF	3x100μF	250	90	70	14	12.5	640
12	2.5	2x150μF	2x22μF	1x470μF	3x100μF	350	90	70	14	12.5	696
5	3.3	2x150μF	4x47μF	1x470μF	3x100μF	250	90	80	20	12.5	640
12	3.3	2x150μF	3x22μF	1x470μF	3x100μF	320	90	80	10	12.5	696
12	5	2x150μF	3x22μF	1x470μF	1x100μF	300	70	120	6	12.5	1066

NOTES:

17. C_{IN} bulk capacitor is optional only for energy buffer from the long input power supply cable.
18. ASCR gain and residual are selected to guarantee that the phase margin is higher than 60° and gain margin is higher than 6dB at room temperature and full load (25A).
19. Output voltage response is tested with load step slew rate higher than 20A/μs.

TABLE 3. RECOMMENDED I/O CAPACITOR IN TABLE 2

VENDORS	VALUE	PART NUMBER
MURATA, Input Ceramic	47μF, 16V, 1210	GRM32ER61C476ME15L
MURATA, Input Ceramic	22μF, 16V, 1210	GRM32ER61E226KE15L
TAIYO YUDEN, Input Ceramic	47μF, 16V, 1210	EMK325BJ476MM-T
TAIYO YUDEN, Input Ceramic	22μF, 25V, 1210	TMK325BJ226MM-T
MURATA, Output Ceramic	100μF, 6.3V, 1210	GRM32ER60J107M
TDK, Output Ceramic	100μF, 6.3V, 1210	C3225X5R0J107M
AVX, Output Ceramic	100μF, 6.3V, 1210	12106D107MAT2A
SANYO POSCAP, Input Bulk	150μF, 16V	16TQC150MYF
SANYO POSCAP, Output Bulk	470μF, 4V	4TPE470MCL
SANYO POSCAP, Output Bulk	470μF, 6.3V	6TPF470MAH

Functional Description

SMBus Communications

The ISL8270M provides an SMBus digital interface that enables the user to configure all aspects of the module operation as well as monitor the input and output parameters. The ISL8270M can be used with any SMBus host device. In addition, the module is compatible with PMBus™ Power System Management Protocol Specification Parts I & II version 1.2. The ISL8270M accepts most standard PMBus commands. When controlling the device with PMBus commands, it is recommended that the enable pin is tied to SGND.

The SMBus device address is the only parameters that must be set by external pins. All other device parameters can be set with PMBus commands.

Output Voltage Selection

The output voltage may be set to a voltage between 0.6V and 5V provided that the input voltage is higher than the desired output voltage by an amount sufficient to maintain regulation.

The VSET pin is used to set the output voltage to levels as shown in Table 4. The R_{SET} resistor is placed between the VSET pin and SGND. A standard 1% resistor is recommend.

TABLE 4. OUTPUT VOLTAGE RESISTOR SETTINGS

V _{OUT} (V)	R _{SET} (kΩ)
0.60	10
0.65	11
0.70	12.1
0.75	13.3
0.80	14.7
0.85	16.2
0.90	17.8
0.95	19.6
1.00	21.5, or Connect to SGND
1.05	23.7
1.10	26.1
1.15	28.7
1.20	31.6, or OPEN
1.25	34.8
1.30	38.3
1.40	42.2
1.50	46.4
1.60	51.1
1.70	56.2
1.80	61.9
1.90	68.1
2.00	75
2.10	82.5
2.20	90.9
2.30	100
2.50	110, or Connect to V25

TABLE 4. OUTPUT VOLTAGE RESISTOR SETTINGS (Continued)

V _{OUT} (V)	R _{SET} (kΩ)
2.80	121
3.00	133
3.30	147
4.00	162
5.00	178

The output voltage may also be set to any value between 0.6V and 5V using a PMBus command VOUT_COMMAND.

By Default, V_{OUT_MAX} is set 110% higher than V_{OUT} set by the pin strap resistor, which can be changed to any value up to 5.5V with PMBus Command VOUT_MAX.

Soft-start Delay and Ramp Times

It may be necessary to set a delay from when an enable signal is received until the output voltage starts to ramp to its target value. In addition, the designer may wish to precisely set the time required for V_{OUT} to ramp to its target value after the delay period has expired. These features may be used as part of an overall in-rush current management strategy or to precisely control how fast a load IC is turned on. The ISL8270M gives the system designer several options for precisely and independently controlling both the delay and ramp time periods. The soft-start delay period begins when the EN pin is asserted and ends when the delay time expires.

The soft-start delay and ramp times can be programmed to custom values with PMBus commands; TON_DELAY and TON_RISE. When the delay time is set to 0ms, the device begins its ramp-up after the internal circuitry has initialized (approximately 2ms). When the soft-start ramp period is set to 0ms, the output ramps up as quickly as the output load capacitance and loop settings allow. It is generally recommended to set the soft-start ramp to a value greater than 500μs to prevent inadvertent fault conditions due to excessive in-rush current.

Power-Good

The ISL8270M provides a Power-Good (PG) signal that indicates the output voltage is within a specified tolerance of its target level and no fault condition exists. By default, the PG pin asserts if the output is within 10% of the target voltage. These limits and the polarity of the pin may be changed with PMBus command POWER_GOOD_ON.

A PG delay period is defined as the time from when all conditions within the ISL8270M for asserting PG are met to when the PG pin is actually asserted. This feature is commonly used instead of using an external reset controller to control external digital logic. A PG delay can be programmed with PMBus command POWER_GOOD_DELAY.

Switching Frequency and PLL

The device's switching frequency is set from 296kHz to 1067kHz using the pin-strap method as shown in Table 2, or by using a PMBus command FREQUENCY_SWITCH. The ISL8270M incorporates an internal phase-locked loop (PLL) to clock the

ISL8270M

internal circuitry. The PLL can be driven by an external clock source connected to the SYNC pin. When using the internal oscillator, the SYNC pin can be configured as a clock source as a external sync to other modules. Refer to SYNC_CONFIG command on page 43 for more information.

TABLE 5. SWITCHING FREQUENCY RESISTOR SETTINGS

F _{SW} (V)	R _{SET} (kΩ)
296	14.7, or Connect to SGND
320	16.2
364	17.8
400	19.6
421	21.5
471	23.7
533	26.1, or OPEN
571	28.7
615	31.6
727	34.8
800	38.3
842	42.2
889	46.4
1067	51.1, or Connect to V25

Loop Compensation

The module is internally compensated via the PMBus command ASCR_CONFIG. The ISL8270M uses the ChargeMode control algorithm that responds to output current changes within a single PWM switching cycle, achieving a smaller total output voltage variation with less output capacitance than traditional PWM controllers.

Input Undervoltage Lockout (UVLO)

The input undervoltage lockout (UVLO) prevents the ISL8270M from operating when the input falls below a preset threshold, indicating the input supply is out of its specified range. The UVLO threshold (V_{UVLO}) can be set between 4.18V and 16V using the pin-strap method as shown in Table 3, or by using a PMBus command VIN_UV_FAULT_LIMIT.

Fault response to an input undervoltage fault can be programmed with PMBus command VIN_UV_FAULT_RESPONSE.

TABLE 6. UVLO RESISTOR SETTINGS

UVLO (V)	R _{UVLO} (kΩ)
4.5	OPEN
10.8	Connect to V25
4.18	26.1
4.59	28.7
5.06	31.6
5.57	34.8

TABLE 6. UVLO RESISTOR SETTINGS (Continued)

UVLO (V)	R _{UVLO} (kΩ)
6.13	38.3
6.75	42.2
7.42	46.4
8.18	51.1
8.99	56.2
9.90	61.9
10.90	68.1
12.00	75
13.20	82.5
14.54	90.9
16.00	100

SMBus Module Address Selection

Each module must have its own unique serial address to distinguish between other devices on the bus. The module address is set by connecting a resistor between the SA pin and SGND. Table 7 lists the available module addresses.

TABLE 7. SMBus ADDRESS RESISTOR SELECTION

R _{SA} (kΩ)	SMBus ADDRESS
10	19h
11	1Ah
12.1	1Bh
13.3	1Ch
14.7	1Dh
16.2	1Eh
17.8	1Fh
19.6	20h
21.5	21h
23.7	22h
26.1	23h
28.7	24h
31.6	25h
34.8, or connect to SGND	26h
38.3	27h
42.2, or Open	28h
46.4	29h
51.1	2Ah
56.2	2Bh
61.9	2Ch
68.1	2Dh
75	2Eh
82.5	2Fh
90.9	30h
100	31h

Output Overvoltage Protection

The ISL8270M offers an internal output overvoltage protection circuit that can be used to protect sensitive load circuitry from being subjected to a voltage higher than its prescribed limits. A hardware comparator is used to compare the actual output voltage (seen at the V_{SEN+} , V_{SEN-} pins) to a threshold set to 15% higher than the target output voltage (the default setting). Fault threshold can be programmed to a desired level with PMBus command `VOUT_OV_FAULT_LIMIT`. If the V_{SEN+} voltage exceeds, this threshold module will initiate an immediate shutdown without retry. Retry settings can be programmed with PMBus command `VOUT_OV_FAULT_RESPONSE`.

Internal to module, two 100Ω resistors are populated from V_{OUT} to V_{SEN+} and SGND to V_{SEN-} to protect from overvoltage conditions in case of open at V_{SENSE} pins and differential remote sense traces due to assembly error. As long as differential remote sense traces have low resistance, V_{OUT} regulation accuracy is not sacrificed.

Output Pre-Bias Protection

An output pre-bias condition exists when an externally applied voltage is present on a power supply's output before the power supply's control IC is enabled. Certain applications require that the converter not be allowed to sink current during start-up if a pre-bias condition exists at the output. The ISL8270M provides pre-bias protection by sampling the output voltage prior to initiating an output ramp.

If a pre-bias voltage lower than the target voltage exists after the pre-configured delay period has expired, the target voltage is set to match the existing pre-bias voltage, and both drivers are enabled. The output voltage is then ramped to the final regulation value at the pre-configured ramp rate.

The actual time the output takes to ramp from the pre-bias voltage to the target voltage varies, depending on the pre-bias voltage, however, the total time elapsed from when the delay period expires and when the output reaches its target value will match the pre-configured ramp time (see Figure 26).

If a pre-bias voltage is higher than the target voltage after the pre-configured delay period has expired, the target voltage is set to match the existing pre-bias voltage, and both drivers are enabled with a PWM duty cycle that would ideally create the pre-bias voltage.

Once the pre-configured soft-start ramp period has expired, the PG pin is asserted (assuming the pre-bias voltage is not higher than the overvoltage limit). The PWM then adjusts its duty cycle to match the original target voltage, and the output ramps down to the pre-configured output voltage.

If a pre-bias voltage is higher than the overvoltage limit, the device does not initiate a turn-on sequence and declares an overvoltage fault condition. The device then responds based on the output overvoltage fault response setting programmed with PMBus command `VOUT_OV_FAULT_RESPONSE`.

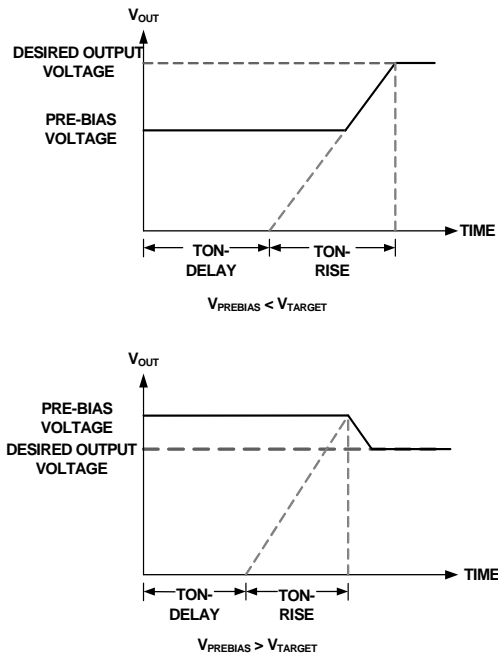

FIGURE 26. OUTPUT RESPONSES TO PRE-BIAS VOLTAGES

Output Overcurrent Protection

The ISL8270M can protect the power supply from damage if the output is shorted to ground or if an overload condition is imposed on the output. Average output overcurrent fault threshold can be programmed with PMBus command `IOUT_OC_FAULT_LIMIT`. Module automatically programs peak inductor current fault threshold, by calculating inductor ripple current by reading real-time input voltage, switching frequency, and `VOUT_COMMAND`. When peak inductor current crosses peak inductor current fault threshold for five successive cycle modules it will initiate an immediate shutdown.

The default response from an overcurrent fault is an immediate shutdown without retry. Retry settings can be programmed with PMBus command `MFR_IOUT_OC_FAULT_RESPONSE`.

Thermal Overload Protection

The ISL8270M includes a thermal sensor that continuously measures the internal temperature of the module and shuts down the controller when the temperature exceeds the preset limit. The default temperature limit is set to $+125^{\circ}\text{C}$ in the factory, but can be changed with PMBus command `OT_FAULT_LIMIT`.

The default response from an over-temperature fault is an immediate shutdown without retry. Retry settings can be programmed with PMBus command `OT_FAULT_RESPONSE`.

If the user has configured the module to retry, the controller waits the preset delay period (if configured to do so) and then checks the module temperature. If the temperature has dropped below a threshold that is approximately $+15^{\circ}\text{C}$ lower than the selected temperature fault limit, the controller attempts to re-start. If the temperature still exceeds the fault limit, the controller waits the preset delay period and retries again.

Digital-DC Bus

The Digital-DC Communications (DDC) bus is used to communicate between Intersil digital power modules and digital controllers. This dedicated bus provides the communication channel between devices for features such as sequencing and fault spreading. The DDC pin on all Digital-DC devices in an application should be connected together. A pull-up resistor is required on the DDC bus in order to guarantee the rise time as shown in Equation 1:

$$\text{Rise Time} = R_{PU} * C_{LOAD} \approx 1\mu\text{s} \quad (\text{EQ. 1})$$

Where R_{PU} is the DDC bus pull-up resistance and C_{LOAD} is the bus loading. The pull-up resistor may be tied to an external 3.3V or 5V supply as long as this voltage is present prior to or during device power-up. In principle, each device connected to the DDC bus presents approximately 10pF of capacitive loading, and each inch of FR4 PCB trace introduces approximately 2pF. The ideal design uses a central pull-up resistor that is well-matched to the total load capacitance.

Phase Spreading

When multiple point-of-load converters share a common DC input supply, it is desirable to adjust the clock phase offset of each device, such that not all devices start to switch simultaneously. Setting each converter to start its switching cycle at a different point in time, can dramatically reduce input capacitance requirements and efficiency losses. Since the peak current drawn from the input supply is effectively spread out over a period of time, the peak current drawn at any given moment is reduced, and the power losses proportional to the I_{RMS}^2 are reduced dramatically.

To enable phase spreading, all converters must be synchronized to the same switching clock. The phase offset of each device may also be set to any value between 0° and 360° in 22.5° increments with PMBus command INTERLEAVE.

Output Sequencing

A group of Digital-DC modules or devices may be configured to power-up in a predetermined sequence. This feature is especially useful when powering advanced processors, (FPGAs and ASICs that require one supply to reach its operating voltage) prior to another supply reaching its operating voltage in order to avoid latch-up. Multi-device sequencing can be achieved by configuring each device with PMBus command SEQUENCE. Multiple device sequencing is configured by issuing PMBus commands to assign the preceding device in the sequencing chain as well as the device that follows in the sequencing chain.

The Enable pins of all devices in a sequencing group must be tied together and driven high to initiate a sequenced turn-on of the group. Enable must be driven low to initiate a sequenced turnoff of the group.

Fault Spreading

Digital DC modules and devices can be configured to broadcast a fault event over the DDC bus to the other devices in the group with PMBus command DDC_GROUP. When a non-destructive fault occurs and the device is configured to shutdown on a fault, the device shuts down and broadcasts the fault event over the

DDC bus. The other devices on the DDC bus shutdown simultaneously, if configured to do so, and attempt to re-start in their prescribed order.

Temperature Monitoring Using XTEMP Pin

The ISL8270M supports measurement of an external device temperature using either a thermal diode integrated in a processor, FPGA or ASIC, or using a discrete diode-connected 2N3904 NPN transistor. Figure 27 illustrates the typical connections required. The external temperature sensors can be used to provide the temperature reading for over temperature and under temperature faults. These options for the external temperature sensors are enabled using the USER_CONFIG PMBus™ command.

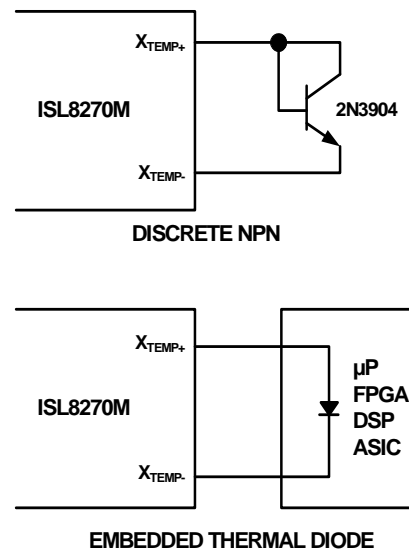

FIGURE 27. EXTERNAL TEMPERATURE MONITORING

Monitoring Via SMBus

A system controller can monitor a wide variety of different ISL8270M system parameters with PMBus commands:

- READ_VIN
- READ_VOUT
- READ_IOUT
- READ_INTERNAL_TEMP
- READ_EXTERNAL_TEMP
- READ_DUTY_CYCLE
- READ_FREQUENCY
- READ_VDRV

Snapshot Parameter Capture

The ISL8270M offers a special feature to capture parametric data and some fault status following a fault. Detail description is provided in “PMBus Commands Description” on page 26 under PMBus command SNAPSHOT and SNAPSHOT_CONTROL.

Non-Volatile Memory

The ISL8270M has internal non-volatile memory where user configurations are stored. Integrated security measures ensure that the user can only restore the module to a level that has been made available to them. During the initialization process, the ISL8270M checks for stored values contained in its internal non-volatile memory.

Modules are shipped with factory defaults configuration and most settings can be overwritten with PMBus Commands and can be stored in non-volatile memory with PMBus command STORE_USER_ALL.

PCB Layout Guidelines

To achieve stable operation, low losses, and good thermal performance some layout considerations are necessary.

- For $VDD > 6V$ recommended PCB layout is shown in Figure 28. Leave V25, VDDC, VR5, and VR6 as no connect.
- For $5.5V \leq VDD \leq 6V$, connect VDDC pin to VR6 pin. For $4.5 \leq VDD < 5.5V$, connect VDDC pin to VR6 and VR5 pin. A RC filter is required at the input of V_{DRVIN} pin if input supply is shared with VIN pin.
- Establish separate SGND plane and PGND plane, then connect SGND to PGND plane as shown in Figure 29 in the middle layer. For making connections between SGND/PGND on the top layer and other layers use multiple vias for each pin to connect to inner SGND/PGND layer. Do not connect SGND directly to PGND on a top layer. Connecting SGND directly to PGND without establishing SGND plane will bypass the decoupling capacitor at internal reference supplies, making controller susceptible to noise. Connect CGND to PGND with vias as shown in Figure 28.
- Place enough ceramic capacitors between VIN and PGND, VOUT and PGND and bypass capacitors between VDD and the ground plane, as close to the module as possible to minimize high frequency noise.
- Use large copper areas for power path (VIN, PGND, VOUT) to minimize conduction loss and thermal stress. Also, use multiple vias to connect the power planes in different layers. Extra ceramic capacitors at VIN and VOUT can be placed on the bottom layer under VIN and VOUT pads when multiple vias are used for connecting copper pads on top and bottom layers.
- Connect differential remote sensing traces to the regulation point to achieve a tight output voltage regulation. Route a trace from and V_{SEN+} to the point-of-load where the tight output voltage is desired. Avoid routing any sensitive signal traces, such as the VSENSE signal near VSWH pads.
- For noise sensitive applications, it is recommended to connect VSWH pads only on the top layer only but thermal performance gets sacrificed. External airflow might be required to keep module heat at desired level. For applications where switching noise is less critical, an excellent thermal performance can be achieved in the ISL8270M module by increasing copper mass attached to VSWH pad. To increase copper mass on the VSWH

node create copper islands in the middle and bottom layers under VSWH pad and connect them to the top layer with multiple vias. Make sure to shield those copper islands with a PGND layer to avoid any interference to noise sensitive signals.

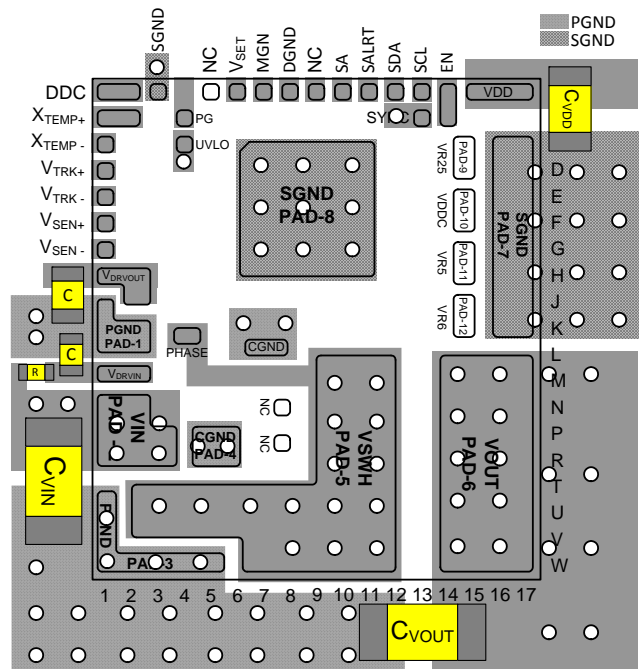

FIGURE 28. RECOMMENDED LAYOUT - TOP PCB LAYER

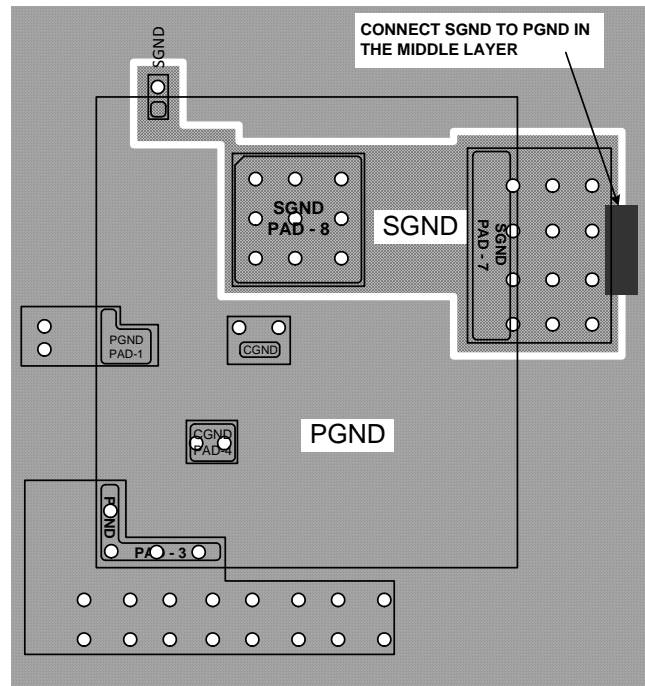

FIGURE 29. RECOMMENDED LAYOUT - CONNECT SGND TO PGND IN THE MIDDLE PCB LAYER AFTER ESTABLISHING SEPARATE SGND AND PGND

Thermal Considerations

Experimental power loss curves along with θ_{JA} from thermal modeling analysis can be used to evaluate the thermal consideration for the module. The derating curves are derived from the maximum power allowed while maintaining the temperature below the maximum junction temperature of +125°C. In actual application, other heat sources and design margin should be considered.

Package Description

The structure of the ISL8270M belongs to the High Density Array (HDA) no-lead package. This kind of package has advantages, such as good thermal and electrical conductivity, low weight and small size. The HDA package is applicable for surface mounting technology and is being more readily used in the industry. The ISL8270M contains several types of devices, including resistors, capacitors, inductors and control ICs. The ISL8270M is a copper lead-frame based package with exposed copper thermal pads, which have good electrical and thermal conductivity. The copper lead frame and multi component assembly is over-molded with polymer mold compound to protect these devices.

The package outline, a typical PCB land pattern design and a typical stencil opening edge position are shown on pages 47, 49 and 50 respectively. The module has a small size of 17mmx19mmx3.55mm. Figure 30 shows typical reflow parameters. These guidelines are general design rules. Users could modify parameters according to their application.

PCB Layout Pattern Design

The bottom of ISL8270M is a lead-frame footprint, which is attached to the PCB by surface mounting process. The PCB land pattern is shown on page 49. The PCB layout pattern is essentially 1:1 with the HDA exposed pad and I/O termination dimensions. The thermal lands on the PCB layout should match 1:1 with the package exposed die pads.

Thermal Vias

A grid of 1.0mm to 1.2mm pitch thermal vias, which drops down and connects to buried copper plane(s), should be placed under the thermal land. The vias should be about 0.3mm to 0.33mm in diameter with the barrel plated to about 1.0 ounce copper. Although adding more vias (by decreasing via pitch) will improve the thermal performance, diminishing returns will be seen as more and more vias are added. Simply use as many vias as practical for the thermal land size and your board design rules allow.

Stencil Pattern Design

Reflowed solder joints on the perimeter I/O lands should have about a 50µm to 75µm (2mil to 3mil) standoff height. The solder paste stencil design is the first step in developing optimized, reliable solder joints. Stencil aperture size to land size ratio should typically be 1:1. The aperture width may be reduced slightly to help prevent solder bridging between adjacent I/O lands. To reduce solder paste volume on the larger thermal lands, it is recommended that an array of smaller apertures be used instead of one large aperture. It is recommended that the stencil printing area cover 50% to 80% of the PCB layout pattern. A typical solder stencil pattern is shown on page 50. The gap width between pad to pad is 0.6mm. The user should consider the symmetry of the whole stencil pattern when designing its pads. A laser cut, stainless steel stencil with electropolished trapezoidal walls is recommended. Electropolishing "smooths" the aperture walls resulting in reduced surface friction and better paste release, which reduces voids. Using a Trapezoidal Section Aperture (TSA) also promotes paste release and forms a "brick like" paste deposit that assists in firm component placement. A 0.1mm to 0.15mm stencil thickness is recommended for this large pitch (1.3mm) HDA.

Reflow Parameters

Due to the low mount height of the HDA, "No Clean" Type 3 solder paste per ANSI/J-STD-005 is recommended. Nitrogen purge is also recommended during reflow. A system board reflow profile depends on the thermal mass of the entire populated board, thus it is not practical to define a specific soldering profile just for the HDA. The profile given in Figure 30 is provided as a guideline, to be customized for varying manufacturing practices and applications.

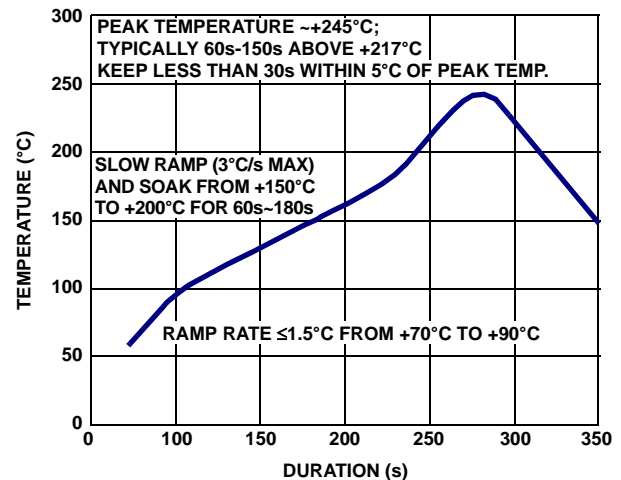

FIGURE 30. TYPICAL REFLOW PROFILE

PMBus Command Summary

COMMAND CODE	COMMAND NAME	DESCRIPTION	TYPE	DATA FORMAT	DEFAULT VALUE	DEFAULT SETTING	PAGE
01h	OPERATION	Sets Enable, Disable and V_{OUT} Margin modes.	R/W BYTE	BIT			26
02h	ON_OFF_CONFIG	Configures the EN pin and PMBus commands to turn the unit ON/OFF	R/W BYTE	BIT	17h	Hardware Enable, Immediate Off	26
03h	CLEAR_FAULTS	Clears fault indications.	SEND BYTE				26
15h	STORE_USER_ALL	Stores all PMBus values written since last restore at user level.	SEND BYTE				26
16h	RESTORE_USER_ALL	Restores PMBus settings that were stored using STORE_USER_ALL.	SEND BYTE				27
20h	VOUT_MODE	Preset to defined data format of V_{OUT} commands.	READ BYTE	BIT	13h	Linear Mode, Exponent = -13	27
21h	VOUT_COMMAND	Sets the nominal value of the output voltage.	R/W WORD	L16u		Pin Strap	27
23h	VOUT_CAL_OFFSET	Applies a fixed offset voltage to the VOUT_COMMAND.	R/W WORD	L16s	0000h	0V	27
24h	VOUT_MAX	Sets the maximum possible value of V_{OUT} . 110% of pin-strap V_{OUT} .	R/W WORD	L16u		1.1* V_{OUT} Pin Strap	27
25h	VOUT_MARGIN_HIGH	Sets the value of the V_{OUT} during a margin high.	R/W WORD	L16u		1.05* V_{OUT} Pin Strap	27
26h	VOUT_MARGIN_LOW	Sets the value of the V_{OUT} during a margin low.	R/W WORD	L16u		0.95* V_{OUT} Pin Strap	28
27h	VOUT_TRANSITION_RATE	Sets the transition rate during margin or other change of V_{OUT} .	R/W WORD	L11	BA00h	1V/ms	28
28h	VOUT_DROOP	Sets the loadline (V/I Slope) resistance for the rail.	R/W WORD	L11	0000h	0mV/A	28
33h	FREQUENCY_SWITCH	Sets the switching frequency.	R/W WORD	L11		Pin Strap	28
37h	INTERLEAVE	Configures a phase offset between devices sharing a SYNC clock.	R/W WORD	BIT	0000h	Set based on PMBus Address	28
38h	IOUT_CAL_GAIN	Sense resistance for inductor DCR current sensing.	R/W WORD	L11	B380h	0.875m Ω	29
39h	IOUT_CAL_OFFSET	Sets the current-sense offset.	R/W WORD	L11	0000h	0A	29
40h	VOUT_OV_FAULT_LIMIT	Sets the V_{OUT} overvoltage fault threshold.	R/W WORD	L16u		1.15* V_{OUT} Pin Strap	29
41h	VOUT_OV_FAULT_RESPONSE	Configures the V_{OUT} overvoltage fault response.	R/W BYTE	BIT	80h	Disable and No Retry	29
42h	VOUT_OV_WARN_LIMIT	Sets the V_{OUT} overvoltage warn threshold.	R/W WORD	L16u		1.10* V_{OUT} Pin Strap	29
43h	VOUT_UV_WARN_LIMIT	Sets the V_{OUT} undervoltage warn threshold.	R/W WORD	L16u		0.9 * V_{OUT} Pin Strap	29
44h	VOUT_UV_FAULT_LIMIT	Sets the V_{OUT} undervoltage fault threshold.	R/W WORD	L16u		0.85* V_{OUT} Pin Strap	30
45h	VOUT_UV_FAULT_RESPONSE	Configures the V_{OUT} undervoltage fault response.	R/W BYTE	BIT	80h	Disable and No Retry	30
46h	IOUT_OC_FAULT_LIMIT	Sets the I_{OUT} average overcurrent fault threshold.	R/W WORD	L11	DBC0h	30A	30
4Bh	IOUT_UC_FAULT_LIMIT	Sets the I_{OUT} average undercurrent fault threshold.	R/W WORD	L11	DC3Fh	-30A	30
4Fh	OT_FAULT_LIMIT	Sets the over-temperature fault threshold.	R/W WORD	L11	EBE8h	+125 °C	30

ISL8270M

PMBus Command Summary (Continued)

COMMAND CODE	COMMAND NAME	DESCRIPTION	TYPE	DATA FORMAT	DEFAULT VALUE	DEFAULT SETTING	PAGE
50h	OT_FAULT_RESPONSE	Configures the over-temperature fault response.	R/W BYTE	BIT	80h	Disable and No Retry	31
51h	OT_WARN_LIMIT	Sets the over-temperature warning limit.	R/W WORD	L11	Eb70h	+110 °C	31
52h	UT_WARN_LIMIT	Sets the under-temperature warning limit.	R/W WORD	L11	DC40h	-30 °C	31
53h	UT_FAULT_LIMIT	Sets the under-temperature fault threshold.	R/W WORD	L11	E530h	-45 °C	31
54h	UT_FAULT_RESPONSE	Configures the under-temperature fault response.	R/W BYTE	BIT	80h	Disable and No Retry	32
55h	VIN_OV_FAULT_LIMIT	Sets the V_{IN} overvoltage fault threshold.	R/W WORD	L11	D380h	14V	32
56h	VIN_OV_FAULT_RESPONSE	Configures the V_{IN} overvoltage fault response.	R/W BYTE	BIT	80h	Disable and No Retry	32
57h	VIN_OV_WARN_LIMIT	Sets the input overvoltage warning limit.	R/W WORD	L11	D327h	12.6V	32
58h	VIN_UV_WARN_LIMIT	Sets the input undervoltage warning limit.	R/W WORD	L11		1.10*VIN UV Fault Limit	33
59h	VIN_UV_FAULT_LIMIT	Sets the V_{IN} undervoltage fault threshold.	R/W WORD	L11		Pin Strap	33
5Ah	VIN_UV_FAULT_RESPONSE	Configures the V_{IN} undervoltage fault response.	R/W BYTE	BIT	80h	Disable and No Retry	33
5Eh	POWER_GOOD_ON	Sets the voltage threshold for Power-Good indication.	R/W WORD	L16u		0.9*VOUT Pin Strap	33
60h	TON_DELAY	Sets the delay time from ENABLE to start of V_{OUT} rise.	R/W WORD	L11	CA80h	5ms	33
61h	TON_RISE	Sets the rise time of V_{OUT} after ENABLE and TON_DELAY.	R/W WORD	L11	CA80h	5ms	34
64h	TOFF_DELAY	Sets the delay time from DISABLE to start of V_{OUT} fall.	R/W WORD	L11	CA80h	5ms	34
65h	TOFF_FALL	Sets the fall time for V_{OUT} after DISABLE and TOFF_DELAY.	R/W WORD	L11	CA80h	5ms	34
78h	STATUS_BYTE	Returns an abbreviated status for fast reads.	READ BYTE	BIT	00h	No Faults	34
79h	STATUS_WORD	Returns information with a summary of the units's fault condition.	READ WORD	BIT	0000h	No Faults	35
7Ah	STATUS_VOUT	Returns the V_{OUT} specific status.	READ BYTE	BIT	00h	No Faults	35
7Bh	STATUS_IOUT	Returns the I_{OUT} specific status.	READ BYTE	BIT	00h	No Faults	36
7Ch	STATUS_INPUT	Returns specific status specific to the input.	READ BYTE	BIT	00h	No Faults	36
7Dh	STATUS_TEMPERATURE	Returns the temperature specific status.	READ BYTE	BIT	00h	No Faults	36
7Eh	STATUS_CML	Returns the Communication, Logic and Memory specific status.	READ BYTE	BIT	00h	No Faults	37
80h	STATUS_MFR_SPECIFIC	Returns the VDRV and External Sync clock specific status.	READ BYTE	BIT	00h	No Faults	37
88h	READ_VIN	Returns the input voltage reading.	READ WORD	L11			37
8Bh	READ_VOUT	Returns the output voltage reading.	READ WORD	L16u			37

ISL8270M

PMBus Command Summary (Continued)

COMMAND CODE	COMMAND NAME	DESCRIPTION	TYPE	DATA FORMAT	DEFAULT VALUE	DEFAULT SETTING	PAGE
8Ch	READ_IOUT	Returns the output current reading.	READ WORD	L11			38
8Dh	READ_INTERNAL_TEMP	Returns the temperature reading internal to the device.	READ WORD	L11			38
8Eh	READ_EXTERNAL_TEMP	Returns the temperature reading from external monitor source.	READ WORD	L11			38
94h	READ_DUTY_CYCLE	Returns the duty cycle reading during the ENABLE state.	READ WORD	L11			38
95h	READ_FREQUENCY	Returns the measured operating switch frequency.	READ WORD	L11			38
99h	MFR_ID	Sets a user defined identification.	R/W BLOCK	ASC		Null	38
9Ah	MFR_MODEL	Sets a user defined model.	R/W BLOCK	ASC		Null	38
9Bh	MFR_REVISION	Sets a user defined revision.	R/W BLOCK	ASC		Null	39
9Ch	MFR_LOCATION	Sets a user defined location identifier.	R/W BLOCK	ASC		Null	39
9Dh	MFR_DATE	Sets a user defined date.	R/W BLOCK	ASC		Null	39
9Eh	MFR_SERIAL	Sets a user define d serialized identifier.	R/W BLOCK	ASC		Null	39
B0h	USER_DATA_00	Sets a user defined data.	R/W BLOCK	ASC		Null	39
D0h	ISENSE_CONFIG	Configures ISENSE related features.	R/W WORD	BIT	05h	256ns Blanking Time, Mid Range	40
D1h	USER_CONFIG	Configures several user-level features.	R/W BYTE	BIT	00h	Open Drain PG, XTEMP Disabled	40
D3h	DDC_CONFIG	Configures the DDC bus.	R/W BYTE	BIT	00h	Set based on PMBus Address	41
D4h	POWER_GOOD_DELAY	Sets the delay between $V_{OUT} > PG$ threshold and asserting the PG pin.	R/W WORD	L11	CA00h	4ms	41
DFh	ASCCR_CONFIG	Configures ASCCR control loop.	R/W BLOCK	CUS	015A0100h	Residual = 90 Gain = 256	41
E0h	SEQUENCE	Identifies the Rail DDC ID to perform multi-rail sequencing.	R/W WORD	BIT	0000h	Prequel and Sequel Disabled	42
E2h	DDC_GROUP	Sets rail DDC IDs to obey faults and margining spreading information.	R/W BLOCK	BIT	000000h	Broadcast Disabled	42
E4h	DEVICE_ID	Returns the 16-byte (character) device identifier string.	READ BLOCK	ASC		Reads Device Version	43
E5h	MFR_IOUT_OC_FAULT_RESPONSE	Configures the IOUT overcurrent fault response.	R/W BYTE	BIT	80h	Disable and No Retry	43
E6h	MFR_IOUT_UC_FAULT_RESPONSE	Configures the IOUT undercurrent fault response.	R/W BYTE	BIT	80h	Disable and No Retry	43
E9h	SYNC_CONFIG	Configures the Sync pin.	R/W BYTE	BIT	00h	Pin Strap	43
EAh	SNAPSHOT	Returns 32-byte read-back of parametric and status values.	READ BLOCK	BIT			44
EBh	BLANK_PARAMS	Returns recently changed parameter values.	READ BLOCK	BIT			44
F3h	SNAPSHOT_CONTROL	Snapshot feature control command.	R/W BYTE	BIT			44
F4h	RESTORE_FACTORY	Restores device to the factory default values.	R/W BLOCK				45

PMBus Command Summary (Continued)

COMMAND CODE	COMMAND NAME	DESCRIPTION	TYPE	DATA FORMAT	DEFAULT VALUE	DEFAULT SETTING	PAGE
F5h	VDRV_OV_FAULT_LIMIT	Returns the VDRV overvoltage threshold.	READ WORD	L11	CB00h	6V	45
F6h	VDRV_UV_FAULT_LIMIT	Returns the VDRV undervoltage threshold.	READ WORD	L11	CA00h	4V	45
F7h	READ_VDRV	Returns the VDRV voltage reading.	READ WORD	L11			45
F8h	VDRV_OV_FAULT_RESPONSE	Returns the VDRV overvoltage response.	READ BYTE	BIT	80h	Disable and No Retry	45
F9h	VDRV_UV_FAULT_RESPONSE	Returns the VDRV undervoltage response.	READ BYTE	BIT	80h	Disable and No Retry	45

PMBus™ Data Formats

Linear-11 (L11)

L11 data format uses 5-bit two's complement exponent (N) and 11-bit two's complement mantissa (Y) to represent real world decimal value (X).

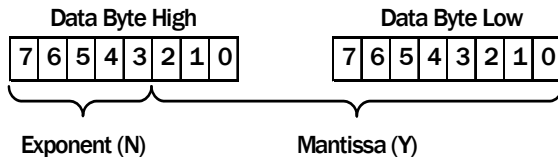

Relation between real world decimal value (X), N and Y is: $X = Y \cdot 2^N$

Linear-16 Unsigned (L16u)

L16u data format uses a fixed exponent (hard-coded to $N = -13h$) and a 16-bit unsigned integer mantissa (Y) to represent real world decimal value (X). Relation between real world decimal value (X), N and Y is: $X = Y \cdot 2^{-13}$

Linear-16 Signed (L16s)

L16s data format uses a fixed exponent (hard-coded to $N = -13h$) and a 16-bit two's complement mantissa (Y) to represent real world decimal value (X).

Relation between real world decimal value (X), N and Y is: $X = Y \cdot 2^{-13}$

Bit Field (BIT)

Break down of Bit Field is provided in PMBus™ on “PMBus Commands Description” on page 26.

Custom (CUS)

Break down of Custom data format is provided in PMBus™ “PMBus Commands Description” on page 26. A combination of Bit Field and integer are common type of Custom data format.

ASCII (ASC)

A variable length string of text characters uses ASCII data format.

PMBus Commands Description

OPERATION (01h)

Definition: Sets Enable, Disable and V_{OUT} Margin settings. Data values of OPERATION that force margin high or low only take effect when the MGN pin is left open (i.e., in the NOMINAL margin state).

Data Length in Bytes: 1

Data Format: BIT

Type: R/W

Default Value:

Units: N/A

SETTINGS	ACTIONS
04h	Immediate off (no sequencing).
44h	Soft off (with sequencing).
84h	On - Nominal.
94h	On - Margin low.
A4h	On - Margin high.

ON_OFF_CONFIG (02h)

Definition: Configures the interpretation and coordination of the OPERATION command and the ENABLE pin (EN).

Data Length in Bytes: 1

Data Format: BIT

Type: R/W

Default Value: 17h (Device starts from ENABLE pin with immediate off)

Units: N/A

SETTINGS	ACTIONS
00h	Device starts any time power is present regardless of ENABLE pin or OPERATION command states.
16h	Device starts from ENABLE pin with soft off.
17h	Device starts from ENABLE pin with immediate off.
1Ah	Device starts from OPERATION command.

CLEAR_FAULTS (03h)

Definition: Clears all fault bits in all registers and releases the SALRT pin (if asserted) simultaneously. If a fault condition still exists, the bit will reassert immediately. This command will not restart a device if it has shut down, it will only clear the faults.

Data Length in Bytes: 0 Byte

Data Format: N/A

Type: Write only

Default Value: N/A

Units: N/A

Reference: N/A

STORE_USER_ALL (15h)

Definition: Stores all PMBus settings from the operating memory to the non-volatile USER store memory. To clear the USER store, perform a RESTORE_FACTORY then STORE_USER_ALL. To add to the USER store, perform a RESTORE_USER_ALL, write commands to be added, then STORE_USER_ALL. This command can be used during device operation, but the device will be unresponsive for 20ms while storing values.

Data Length in Bytes: 0

Data Format: N/A

Type: Write only

Default Value: N/A

Units: N/A

RESTORE_USER_ALL (16h)

Definition: Restores all PMBus settings from the USER store memory to the operating memory. Command performed at power-up. Security level is changed to Level 1 following this command. This command can be used during device operation, but the device will be unresponsive for 20ms while storing values.

Data Length in Bytes: 0

Data Format: N/A

Type: Write only

Default Value: N/A

Units: N/A

VOUT_MODE (20h)

Definition: Reports the V_{OUT} mode and provides the exponent used in calculating several V_{OUT} settings. Fixed with linear mode with default exponent (N) = -13

Data Length in Bytes: 1

Data Format: BIT

Type: Read-only

Default Value: 13h (Linear Mode, N = -13)

Units: N/A

VOUT_COMMAND (21h)

Definition: This command sets or reports the target output voltage. This command cannot set a value higher than either V_{OUT_MAX} or 110% of the pin strap V_{OUT} setting.

Data Length in Bytes: 2

Data Format: L16u

Type: R/W

Default Value: Pin strap setting

Units: Volts

Range: 0V to V_{OUT_MAX}

VOUT_CAL_OFFSET (23h)

Definition: The $V_{OUT_CAL_OFFSET}$ command is used to apply a fixed offset voltage to the output voltage command value. This command is typically used by the user to calibrate a device in the application circuit.

Data Length in Bytes: 2

Data Format: L16s

Type: R/W

Default Value: 0000h

Units: Volts

VOUT_MAX (24h)

Definition: The V_{OUT_MAX} command sets an upper limit on the output voltage the unit can command regardless of any other commands or combinations. The intent of this command is to provide a safeguard against a user accidentally setting the output voltage to a possibly destructive level rather than to be the primary output overprotection. Default value can be changed via PMBus.

Data Length in Bytes: 2

Data Format: L16u

Type: R/W

Default Value: 1.10x $V_{OUT_COMMAND}$ pin strap setting

Units: Volts

Range: 0V to 4V

VOUT_MARGIN_HIGH (25h)

Definition: Sets the value of the V_{OUT} during a margin high. This $V_{OUT_MARGIN_HIGH}$ command loads the unit with the voltage to which the output is to be changed when the OPERATION command is set to "Margin High".

Data Length in Bytes: 2

Data Format: L11

Type: R/W word

Default value: 1.05 x $V_{OUT_COMMAND}$ pin strap setting

Units: V

Range: 0V to V_{OUT_MAX}

VOUT_MARGIN_LOW (26h)

Definition: Sets the value of the V_{OUT} during a margin low. This VOUT_MARGIN_LOW command loads the unit with the voltage to which the output is to be changed when the OPERATION command is set to “Margin Low”.

Data Length in Bytes: 2

Data Format: L11

Type: R/W

Default value: 0.95 x VOUT_COMMAND pin strap setting

Units: V

Range: 0V to VOUT_MAX

VOUT_TRANSITION_RATE (27h)

Definition: This command sets the rate at which the output should change voltage when the device receives an OPERATION command (Margin High, Margin Low) that causes the output voltage to change. The maximum possible positive value of the two data bytes indicates that the device should make the transition as quickly as possible.

Data Length in Bytes: 2

Data Format: L11

Type: R/W

Default value: BA00h (1.0 V/ms)

Units: V/ms

Range: 0.1 to 4V/ms

VOUT_DROOP (28h)

Definition: The VOUT_DROOP sets the effective load line (V/I slope) for the rail in which the device is used. It is the rate, in mV/A at which the output voltage decreases (or increases) with increasing (or decreasing) output current for use with Adaptive Voltage Positioning schemes.

Data Length in Bytes: 2

Data Format: L11

Type: R/W

Default value: 0000h (0mV/A)

Units: mV/A

Range: 0 to 40mV/A

FREQUENCY_SWITCH (33h)

Definition: Sets the switching frequency of the device. Initial default value is defined by a pin strap and this value can be overridden by writing this command via PMBus. If an external SYNC is utilized, this value should be set as close as possible to the external clock value. The output must be disabled when writing this command.

Data Length in Bytes: 2

Data Format: L11

Type: R/W

Default Value: Pin strap setting

Units: kHz

Range: 300kHz to 1066MHz

INTERLEAVE (37h)

Definition: Configures the phase offset of a device that is sharing a common SYNC clock with other devices. A value of 0 for the Number in Group field is interpreted as 16, to allow for phase spreading groups of up to 16 devices.

Data Length in Bytes: 2

Data Format: BIT

Type: R/W

Default Value: Pin strap setting

Units: kHz

BITS	PURPOSE	VALUE	DESCRIPTION
15:2	Reserved	0	Reserved
11:8	Group Number	0 to 15	Sets a number to a group of interleaved rails
7:4	Number in Group	0 to 15	Sets the number of rails in the group A value of 0 is interpreted as 16
3:0	Position in Group	0 to 15	Sets position of the device's rail within the group

IOUT_CAL_GAIN (38h)

Definition: Sets the effective impedance across the current sense circuit for use in calculating output current at +25°C.

Data Length in Bytes: 2

Data Format: L11.

Type: R/W

Default Value: B380h (0.875mΩ)

Units: mΩ

IOUT_CAL_OFFSET (39h)

Definition: Used to null out any offsets in the output current sensing circuit, and to compensate for delayed measurements of current ramp due to Isense blanking time.

Data Length in Bytes: 2

Data Format: 11.

Type: R/W

Default Value: 0000h (0A)

Units: A

VOUT_OV_FAULT_LIMIT (40h)

Definition: Sets the V_{OUT} overvoltage fault threshold.

Data Length in Bytes: 2

Data Format: L16u

Type: R/W

Default Value: 1.15xV_{OUT_COMMAND} pin strap setting

Units: V

Range: 0V to V_{OUT_MAX}

VOUT_OV_FAULT_RESPONSE (41h)

Definition: Configures the V_{OUT} overvoltage fault response. Note that the device cannot be set to ignore this fault mode.

Data Length in Bytes: 1

Data Format: BIT

Type: R/W

Default Value: 80h (Disable and no retry)

Units: N/A

SETTINGS	ACTIONS
80h	Disable with no retry
BFh	Disable and continuous retry with 70ms delay

VOUT_OV_WARNING_LIMIT (42h)

Definition: Sets the V_{OUT} overvoltage warning threshold. Power-Good signal is pulled low when output voltage goes higher than this threshold.

Data Length in Bytes: 2

Data Format: L16u

Type: R/W

Default Value: 0.85xV_{OUT_COMMAND} pin strap setting

Units: V

Range: 0V to V_{OUT_MAX}

VOUT_UV_WARNING_LIMIT (43h)

Definition: Sets the V_{OUT} undervoltage warning threshold. Power-Good signal is pulled low when output voltage goes lower than this threshold.

Data Length in Bytes: 2

Data Format: L16u

Type: R/W

Default Value: 0.85xV_{OUT_COMMAND} pin strap setting

Units: V

Range: 0V to V_{OUT_MAX}

VOUT_UV_FAULT_LIMIT (44h)

Definition: Sets the V_{OUT} undervoltage fault threshold. This fault is masked during ramp or when disabled.

Data Length in Bytes: 2

Data Format: L16u

Type: R/W

Default Value: 0.85xVOUT_COMMAND pin strap setting

Units: V

Range: 0V to VOUT_MAX

VOUT_UV_FAULT_RESPONSE (45h)

Definition: Configures the V_{OUT} undervoltage fault response.

Data Length in Bytes: 1

Data Format: BIT

Type: R/W

Default Value: 80h (Disable, no retry)

Units: N/A

SETTINGS	ACTIONS
80h	Disable with no retry
BfH	Disable and continuous retry with 70ms delay

IOUT_OC_FAULT_LIMIT (46h)

Definition: Sets the I_{OUT} average overcurrent fault threshold. Device will automatically calculate peak inductor overcurrent fault limit.

Data Length in Bytes: 2

Data Format: L11

Type: R/W

Default Value: DBC0h (30A)

Units: A

Range: -100 to 100A

IOUT_UC_FAULT_LIMIT (4Bh)

Definition: Sets the I_{OUT} average undercurrent fault threshold. Device will automatically calculate valley inductor undercurrent fault limit.

Data Length in Bytes: 2

Data Format: L11

Type: R/W

Default Value: -1xIOUT_OC_FAULT_LIMIT

Units: A

Range: -100 to 100A

OT_FAULT_LIMIT (4Fh)

Definition: The OT_FAULT_LIMIT command sets the temperature at which the device should indicate an over-temperature fault. Note that the temperature must drop below OT_WARN_LIMIT to clear this fault.

Data Length in Bytes: 2

Data Format: L11

Type: R/W

Default Value: EBE8h (+125°C)

Units: Celsius

Range: 0°C to +175°C

OT_FAULT_RESPONSE (50h)

Definition: The OT_FAULT_RESPONSE command instructs the device on what action to take in response to an over-temperature fault.

Data Length in Bytes: 1

Data Format: BIT

Type: R/W

Fault Value: 80h (Disable and no retry)

Units: N/A

SETTINGS	ACTIONS
80h	Disable with no retry
BFh	Disable and continuous retry with 70ms delay

OT_WARN_LIMIT (51h)

Definition: The OT_WARN_LIMIT command sets the temperature at which the device should indicate an over-temperature warning alarm. In response to the OT_WARN_LIMIT being exceeded, the device: Sets the TEMPERATURE bit in STATUS_WORD, Sets the OT_WARNING bit in STATUS_TEMPERATURE, and notifies the host.

Data Length in Bytes: 2

Data Format: Linear-11.

Type: R/W

Default Value: EB70h (+110 °C)

Units: Celsius

Range: 0 °C to +175 °C

UT_WARN_LIMIT (52h)

Definition: The UT_WARN_LIMIT command set the temperature at which the device should indicate an under-temperature Warning alarm. In response to the UT_WARN_LIMIT being exceeded, the device: Sets the TEMPERATURE bit in STATUS_WORD, Sets the UT_WARNING bit in STATUS_TEMPERATURE, and notifies the host.

Data Length in Bytes: 2

Data Format: L11.

Type: R/W

Default Value: DC40h (-30 °C)

Units: Celsius

Range: -55 °C to +25 °C

UT_FAULT_LIMIT (53h)

Definition: The UT_FAULT_LIMIT command sets the temperature, in degrees Celsius, of the unit where it should indicate an under-temperature fault. Note that the temperature must rise above UT_WARN_LIMIT to clear this fault.

Data Length in Bytes: 2

Data Format: L11

Type: R/W

Default Value: E530h (-45 °C)

Units: Celsius

Range: -55 °C to +25 °C

UT_FAULT_RESPONSE (54h)

Definition: Configures the under-temperature fault response as defined by the following table. The delay time is the time between restart attempts.

Data Length in Bytes: 1

Data Format: BIT

Type: R/W

Default Value: 80h (Disable, no retry)

Units: N/A

SETTINGS	ACTIONS
80h	Disable with no retry
BFh	Disable and continuous retry with 70ms delay

VIN_OV_FAULT_LIMIT (55h)

Definition: Sets the V_{IN} overvoltage fault threshold.

Data Length in Bytes: 2

Data Format: L11

Type: R/W

Default Value: D380h (14V)

Units: V

Range: 0V to 16V

VIN_OV_FAULT_RESPONSE (56h)

Definition: Configures the V_{IN} overvoltage fault response as defined by the following table. The delay time is the time between restart attempts.

Data Length in Bytes: 1

Data Format: BIT

Type: R/W

Default Value: 80h (Disable and no retry)

Units: N/A

SETTINGS	ACTIONS
80h	Disable with no retry
BFh	Disable and continuous retry with 70ms delay

VIN_OV_WARN_LIMIT (57h)

Definition: Sets the V_{IN} overvoltage warning threshold as defined by the table below. In response to the OV_WARN_LIMIT being exceeded, the device: Sets the NONE OF THE ABOVE and INPUT bits in STATUS_WORD, Sets the VIN_OV_WARNING bit in STATUS_INPUT, and notifies the host.

Data Length in Bytes: 2

Data Format: L11.

Type: R/W

Protectable: Yes

Default Value: D327h (12.6V)

Units: V

Range: 0V to 16V

VIN_UV_WARN_LIMIT (58h)

Definition: Sets the VIN undervoltage warning threshold. If a VIN_UV_FAULT occurs, the input voltage must rise above VIN_UV_WARN_LIMIT to clear the fault, which provides hysteresis to the fault threshold. In response to the UV_WARN_LIMIT being exceeded, the device: Sets the NONE OF THE ABOVE and INPUT bits in STATUS_WORD, Sets the VIN_UV_WARNING bit in STATUS_INPUT, and notifies the host.

Data Length in Bytes: 2

Data Format: Linear-11.

Type: R/W

Default Value: 1.1 x VIN_UV_FAULT_LIMIT pin strap setting

Units: V

Range: 0V to 12V

VIN_UV_FAULT_LIMIT (59h)

Definition: Sets the V_{IN} undervoltage fault threshold.

Data Length in Bytes: 2

Data Format: L11

Type: R/W

Default Value: Pin strap setting

Units: V

Range: 0V to 12V

VIN_UV_FAULT_RESPONSE (5Ah)

Definition: Configures the V_{IN} undervoltage fault response as defined by the following table. The delay time is the time between restart attempts.

Data Length in Bytes: 1

Data Format: BIT

Type: R/W

Default Value: 80h (Disable and no retry)

Units: N/A

SETTINGS	ACTIONS
80h	Disable with no retry
BFh	Disable and continuous retry with 70ms delay

POWER_GOOD_ON (5Eh)

Definition: Sets the voltage threshold for Power-Good indication. Power-Good asserts when the output voltage exceeds POWER_GOOD_ON and de-asserts when the output voltage is less than VOUT_UV_FAULT_LIMIT.

Data Length in Bytes: 2

Data Format: L16u

Type: R/W

Default Value: 0.9xVOUT_COMMAND pin strap setting

Units: V

TON_DELAY (60h)

Definition: Sets the delay time from when the device is enabled to the start of V_{OUT} rise.

Data Length in Bytes: 2

Data Format: L11

Type: R/W

Default Value: 5

Units: ms

Range: 0 to 500ms

ISL8270M

TON_RISE (61h)

Definition: Sets the rise time of V_{OUT} after ENABLE and TON_DELAY.

Data Length in Bytes: 2

Data Format: L11

Type: R/W

Default Value: 5

Units: ms

Range: 0 to 200ms

TOFF_DELAY (64h)

Definition: Sets the delay time from DISABLE to start of V_{OUT} fall.

Data Length in Bytes: 2

Data Format: L11

Type: R/W

Default Value: 5

Units: ms

Range: 0 to 500 seconds

TOFF_FALL (65h)

Definition: Sets the fall time for V_{OUT} after DISABLE and TOFF_DELAY.

Data Length in Bytes: 2

Data Format: L11

Type: R/W

Default Value: 5

Units: ms

Range: 0 to 200ms

STATUS_BYTE (78h)

Definition: The STATUS_BYTE command returns one byte of information with a summary of the most critical faults.

Data Length in Bytes: 1

Data Format: BIT

Type: Read-only

Default Value: 00h

Units: N/A

BIT NUMBER	STATUS BIT NAME	MEANING
7	BUSY	A fault was declared because the device was busy and unable to respond.
6	OFF	This bit is asserted if the unit is not providing power to the output, regardless of the reason, including simply not being enabled.
5	VOUT_OV_FAULT	An output overvoltage fault has occurred.
4	IOUT_OC_FAULT	An output overcurrent fault has occurred.
3	VIN_UV_FAULT	An input undervoltage fault has occurred.
2	TEMPERATURE	A temperature fault or warning has occurred.
1	CML	A communications, memory or logic fault has occurred.
0	NONE OF THE ABOVE	A fault or warning not listed in bits 7:1 has occurred.

ISL8270M

STATUS_WORD (79h)

Definition: The STATUS_WORD command returns two bytes of information with a summary of the unit's fault condition. Based on the information in these bytes, the host can get more information by reading the appropriate status registers. The low byte of the STATUS_WORD is the same register as the STATUS_BYTE (78h) command.

Data Length in Bytes: 2

Data Format: BIT

Type: Read-only

Default Value: 0000h

Units: N/A

BIT NUMBER	STATUS BIT NAME	MEANING
15	VOUT	An output voltage fault or warning has occurred.
14	IOUT/POUT	An output current or output power fault or warning has occurred.
13	INPUT	An input voltage, input current, or input power fault or warning has occurred.
12	MFG_SPECIFIC	A manufacturer specific fault or warning has occurred.
11	POWER_GOOD#	The POWER_GOOD signal, if present, is negated.
10	FANS	A fan or airflow fault or warning has occurred.
9	OTHER	A bit in STATUS_OTHER is set.
8	UNKNOWN	A fault type not given in bits 15:1 of the STATUS_WORD has been detected.
7	BUSY	A fault was declared because the device was busy and unable to respond.
6	OFF	This bit is asserted if the unit is not providing power to the output, regardless of the reason, including simply not being enabled.
5	VOUT_OV_FAULT	An output overvoltage fault has occurred.
4	IOUT_OC_FAULT	An output overcurrent fault has occurred.
3	VIN_UV_FAULT	An input undervoltage fault has occurred.
2	TEMPERATURE	A temperature fault or warning has occurred.
1	CML	A communications, memory or logic fault has occurred.
0	NONE OF THE ABOVE	A fault or warning not listed in bits 7:1 has occurred.

STATUS_VOUT (7Ah)

Definition: The STATUS_VOUT command returns one data byte with the status of the output voltage.

Data Length in Bytes: 1

Data Format: BIT

Type: Read-only

Default Value: 00h

Units: N/A

BIT NUMBER	STATUS BIT NAME	MEANING
7	VOUT_OV_FAULT	Indicates an output overvoltage fault.
6	VOUT_OV_WARNING	Indicates an output overvoltage warning.
5	VOUT_UV_WARNING	Indicates an output undervoltage warning.
4	VOUT_UV_FAULT	Indicates an output undervoltage fault.
3:0	N/A	These bits are not used.

ISL8270M

STATUS_IOUT (7Bh)

Definition: The STATUS_IOUT command returns one data byte with the status of the output current.

Data Length in Bytes: 1

Data Format: BIT

Type: Read-only

Default Value: 00h

Units: N/A

BIT NUMBER	STATUS BIT NAME	MEANING
7	IOUT_OC_FAULT	An output overcurrent fault has occurred.
6	IOUT_OC_LV_FAULT	An output overcurrent and low voltage fault has occurred.
5	IOUT_OC_WARNING	An output overcurrent warning has occurred.
4	IOUT_UC_FAULT	An output undercurrent fault has occurred.
3:0	N/A	These bits are not used.

STATUS_INPUT (7Ch)

Definition: The STATUS_INPUT command returns input voltage and input current status information.

Data Length in Bytes: 1

Data Format: BIT

Type: Read-only

Default Value: 00h

Units: N/A

BIT NUMBER	STATUS BIT NAME	MEANING
7	VIN_OV_FAULT	An input overvoltage fault has occurred.
6	VIN_OV_WARNING	An input overvoltage warning has occurred.
5	VIN_UV_WARNING	An input undervoltage warning has occurred.
4	VIN_UV_FAULT	An input undervoltage fault has occurred.
3:0	N/A	These bits are not used.

STATUS_TEMP (7Dh)

Definition: The STATUS_TEMP command returns one byte of information with a summary of any temperature related faults or warnings.

Data Length in Bytes: 1

Data Format: BIT

Type: Read-only

Default Value: 00h

Units: N/A

BIT NUMBER	STATUS BIT NAME	MEANING
7	OT_FAULT	An over-temperature fault has occurred.
6	OT_WARNING	An over-temperature warning has occurred.
5	UT_WARNING	An under-temperature warning has occurred.
4	UT_FAULT	An under-temperature fault has occurred.
3:0	N/A	These bits are not used.

ISL8270M

STATUS_CML (7Eh)

Definition: The STATUS_CML command returns one byte of information with a summary of any Communications, Logic and/or Memory errors.

Data Length in Bytes: 1

Data Format: BIT

Type: Read-only

Default Value: 00h

Units: N/A

BIT NUMBER	MEANING
7	Invalid or unsupported PMBus command was received.
6	The PMBus command was sent with invalid or unsupported data.
5	packet error was detected in the PMBus command.
4:2	Not Used.
1	A PMBus command tried to write to a read-only or protected command, or a communication fault other than the ones listed in this table has occurred.
0	Not Used.

STATUS_MFR_SPECIFIC (80h)

Definition: The STATUS_MFR_SPECIFIC command returns one byte of information providing the status of the device's voltage monitoring and clock synchronization faults. VDRV OV/UV warnings are set at $\pm 10\%$ of the VMON_FAULT commands.

Data Length in Bytes: 1

Data Format: BIT

Type: Read only

Default value: 00h

Units: N/A

BIT NUMBER	FIELD NAME	MEANING
7:6	Reserved	
5	VDRV UV Warning	The voltage on the VMON pin has dropped 10% below the level set by VDRV_UV_FAULT.
4	VDRV OV Warning	The voltage on the VMON pin has risen 10% above the level set by VDRV_OV_FAULT.
3	External Switching Period Fault	Loss of external clock synchronization has occurred.
2	Reserved	
1	VDRV UV Fault	The voltage on the VMON pin has dropped below the level set by VDRV_UV_FAULT.
0	VDRV OV Fault	The voltage on the VMON pin has risen above the level set by VDRV_OV_FAULT.

READ_VIN (88h)

Definition: Returns the input voltage reading.

Data Length in Bytes: 2

Data Format: L11

Type: Read-only

Units: V

READ_VOUT (8Bh)

Definition: Returns the output voltage reading.

Data Length in Bytes: 2

Data Format: L16u

Type: Read-only

Units: V

READ_IOUT (8Ch)

Definition: Returns the output current reading.

Data Length in Bytes: 2

Data Format: L11

Type: Read-only

Default Value: N/A

Units: A

READ_INTERNAL_TEMP (8Dh)

Definition: Returns the controller junction temperature reading from internal temperature sensor.

Data Length in Bytes: 2

Data Format: L11

Type: Read-only

Units: °C

READ_EXTERNAL_TEMP (8Eh)

Definition: Returns the temperature reading from the external temperature device connected to XTEMP pins.

Data Length in Bytes: 2

Data Format: L11

Type: Read-only

Units: °C

READ_DUTY_CYCLE (94h)

Definition: Reports the actual duty cycle of the converter during the enable state.

Data Length in Bytes: 2

Data Format: L11

Type: Read only

Units: %

READ_FREQUENCY (95h)

Definition: Reports the actual switching frequency of the converter during the enable state.

Data Length in Bytes: 2

Data Format: L11

Type: Read only

Units: kHz

MFR_ID (99h)

Definition: MFR_ID sets user defined identification. The sum total of characters in MFR_ID, MFR_MODEL, MFR_REVISION, MFR_LOCATION, MFR_DATE, MFR_SERIAL and USER_DATA_00 plus one byte per command cannot exceed 128 characters. This limitation includes multiple writes of this command before a STORE command. To clear multiple writes, perform a RESTORE, write this command then perform a STORE/RESTORE.

Data Length in Bytes: user defined

Data Format: ASCII

Type: Block R/W

Default Value: null

Units: N/A

MFR_MODEL (9Ah)

Definition: MFR_MODEL sets a user defined model. The sum total of characters in MFR_ID, MFR_MODEL, MFR_REVISION, MFR_LOCATION, MFR_DATE, MFR_SERIAL and USER_DATA_00 plus one byte per command cannot exceed 128 characters. This limitation includes multiple writes of this command before a STORE command. To clear multiple writes, perform a RESTORE, write this command then perform a STORE/RESTORE.

Data Length in Bytes: user defined

Data Format: ASC

Type: Block R/W

Default Value: null

Units: N/A

MFR_REVISION (9Bh)

Definition: MFR_REVISION sets a user defined revision. The sum total of characters in MFR_ID, MFR_MODEL, MFR_REVISION, MFR_LOCATION, MFR_DATE, MFR_SERIAL and USER_DATA_00 plus one byte per command cannot exceed 128 characters. This limitation includes multiple writes of this command before a STORE command. To clear multiple writes, perform a RESTORE, write this command then perform a STORE/RESTORE.

Data Length in Bytes: user defined

Data Format: ASC

Type: Block R/W

Default Value: null

Units: N/A

MFR_LOCATION (9Ch)

Definition: MFR_LOCATION sets a user defined location identifier. The sum total of characters in MFR_ID, MFR_MODEL, MFR_REVISION, MFR_LOCATION, MFR_DATE, MFR_SERIAL and USER_DATA_00 plus one byte per command cannot exceed 128 characters. This limitation includes multiple writes of this command before a STORE command. To clear multiple writes, perform a RESTORE, write this command then perform a STORE/RESTORE.

Data Length in Bytes: user defined

Data Format: ASC

Type: Block R/W

Default Value: null

Units: N/A

MFR_DATE (9Dh)

Definition: MFR_DATE sets a user defined date. The sum total of characters in MFR_ID, MFR_MODEL, MFR_REVISION, MFR_LOCATION, MFR_DATE, MFR_SERIAL and USER_DATA_00 plus one byte per command cannot exceed 128 characters. This limitation includes multiple writes of this command before a STORE command. To clear multiple writes, perform a RESTORE, write this command then perform a STORE/RESTORE.

Data Length in Bytes: user defined

Data Format: ASC

Type: Block R/W

Default Value: null

Units: N/A

Reference: N/A

MFR_SERIAL (9Eh)

Definition: MFR_SERIAL sets a user defined serialized identifier. The sum total of characters in MFR_ID, MFR_MODEL, MFR_REVISION, MFR_LOCATION, MFR_DATE, MFR_SERIAL and USER_DATA_00 plus one byte per command cannot exceed 128 characters. This limitation includes multiple writes of this command before a STORE command. To clear multiple writes, perform a RESTORE, write this command then perform a STORE/RESTORE.

Data Length in Bytes: user defined

Data Format: ASC

Type: Block R/W

Default Value: null

Units: N/A

USER_DATA_00 (B0h)

Definition: USER_DATA_00 sets a user defined data. The sum total of characters in MFR_ID, MFR_MODEL, MFR_REVISION, MFR_LOCATION, MFR_DATE, MFR_SERIAL and USER_DATA_00 plus one byte per command cannot exceed 128 characters. This limitation includes multiple writes of this command before a STORE command. To clear multiple writes, perform a RESTORE, write this command then perform a STORE/RESTORE.

Data Length in Bytes: user defined

Data Format: ASCII

Type: Block R/W

Default Value: null

Units: N/A

ISL8270M

ISENSE_CONFIG (D0h)

Definition: Configures current sense circuitry.

Data Length in Bytes: 1

Data Format: BIT

Type: R/W word

Default Value: 05h

Units: N/A

BIT	FIELD NAME	VALUE	SETTING	DESCRIPTION
7:4	Reserved	000		
3:2	Current Sense Blanking Time	00	192ns	Sets the blanking time current sense blanking time.
		01	256ns	
		10	412ns	
		11	640ns	
1:0	Current Sense Range	00	Low Range	±25mV
		01	Mid Range	±35mV
		10	High Range	±50mV
		11	Not Used	

USER_CONFIG (D1h)

Definition: Configures several user-level features. This command overrides the CONFIG pin settings.

Data Length in Bytes: 1

Data Format: BIT

Type: R/W

Default Value: 00h

Units: N/A

BIT	FIELD NAME	VALUE	SETTING	DESCRIPTION
7:5	Reserved	0		Reserved.
4:3	Ramp-Up and Ramp-Down Minimum Duty Cycle	00	0.39%	Sets the minimum duty-cycle during start-up and shutdown ramp. Must be enabled with Bit 10.
		01	0.78%	
		10	1.17%	
		11	1.56%	
2	Minimum Duty Cycle Control	0	Disable	Control for minimum duty cycle.
		1	Enable	
1	Power-Good Pin Configuration	0	Open Drain	0 = PG is open drain output. 1 = PG is push-pull output.
		1	Push-Pull	
0	XTEMP Enable	0	Disable	Enable external temperature monitoring.
		1	Enable	

ISL8270M

DDC_CONFIG (D3h)

Definition: Configures DDC addressing.

Data Length in Bytes: 1

Data Format: BIT

Type: R/W

Default Value: 00h

Units: N/A

BIT	FIELD NAME	VALUE	SETTING	DESCRIPTION
7:5	Reserved	00	Reserved	Reserved.
4:0	Rail ID	0 to 31 (00 to 1Fh)	0	Configures DDC address

POWER_GOOD_DELAY (D4h)

Definition: Sets the delay applied between the output exceeding the PG threshold (POWER_GOOD_ON) and asserting the PG pin. The delay time can range from 0ms up to 500ms, in steps of 125ns. A 1ms minimum configured value is recommended to apply proper de-bounce to this signal.

Data Length in Bytes: 2

Data Format: L11

Type: R/W

Default Value: 1ms

Units: ms

Range: 0 to 5s

ASCR_CONFIG (DFh)

Definition: Allows user configuration of ASCR settings.

Data Length in Bytes: 4

Data Format: CUS

Type: R/W

Default Value: 015A0100h

BIT	PURPOSE	DATA Format	VALUE	DESCRIPTION
31:25	Unused		0000000h	Unused
24	ASCCR Enable	BIT	1	Enable
			0	Disable
23:16	ASCR Residual Setting	Integer		
15:0	ASCR Gain Setting	Integer		

ISL8270M

SEQUENCE (E0h)

Definition: Identifies the Rail DDC ID of the prequel and sequel rails when performing multi-rail sequencing. The device will enable its output when its EN or OPERATION enable states, as defined by ON_OFF_CONFIG, is set and the prequel device has issued a Power-Good event on the DDC bus. The device will disable its output (using the programmed delay values) when the sequel device has issued a Power-Down event on the DDC bus.

The data field is a two-byte value. The most-significant byte contains the 5-bit Rail DDC ID of the prequel device. The least-significant byte contains the 5-bit Rail DDC ID of the sequel device. The most significant bit of each byte contains the enable of the prequel or sequel mode. This command overrides the corresponding sequence configuration set by the CONFIG pin settings.

Data Length in Bytes: 2

Data Format: BIT

Type: R/W

Default Value: 00h (Prequel and Sequel disabled)

BIT	FIELD NAME	VALUE	SETTING	DESCRIPTION
15	Prequel Enable	0	Disable	Disable, no prequel preceding this rail.
		1	Enable	Enable, prequel to this rail is defined by bits 12:8.
14:13	Reserved	0	Reserved	Reserved.
12:8	Prequel Rail DDC ID	0-31	DDC ID	Set to the DDC ID of the prequel rail.
7	Sequel Enable	0	Disable	Disable, no sequel following this rail.
		1	Enable	Enable, sequel to this rail is defined by bits 4:0.
6:5	Reserved	0	Reserved	Reserved.
4:0	Sequel Rail DDC ID	0-31	DDC ID	Set to the DDC ID of the sequel rail.

DDC_GROUP (E2h)

Definition: This command configures fault spreading group ID and enable, broadcast OPERATION group ID and enable, and broadcast VOUT_COMMAND group ID and enable.

Data Length in Bytes: 3

Data Format: BIT

Type: R/W

Default Value: 0000h (Ignore BROADCAST VOUT_COMMAND and OPERATION, Sequence shutdown on POWER_FAIL event)

BITS	PURPOSE	VALUE	DESCRIPTION
23:22	Reserved	0	Reserved
21	BROADCAST_VOUT_COMMAND Response	1	Responds to BROADCAST_VOUT_COMMAND with same Group ID.
		0	Ignores BROADCAST_VOUT_COMMAND.
20:16	BROADCAST_VOUT_COMMAND Group ID	0-31d	Group ID sent as data for broadcast BROADCAST_VOUT_COMMAND events.
15:14	Reserved	0	Reserved.
13	BROADCAST_OPERATION Response	1	Responds to BROADCAST_OPERATION with same Group ID.
		0	Ignores BROADCAST_OPERATION.
12:8	BROADCAST_OPERATION Group ID	0-31d	Group ID sent as data for broadcast BROADCAST_OPERATION events.
7:6	Reserved	0	Reserved.
5	POWER_FAIL Response	1	Responds to POWER_FAIL events with same Group ID by shutting down immediately.
		0	Responds to POWER_FAIL events with same Group ID with sequenced shutdown.
4:0	POWER_FAIL group ID	0-31d	Group ID sent as data for broadcast POWER_FAIL events.

ISL8270M

DEVICE_ID (E4h)

Definition: Returns the 16-byte (character) device identifier string.

Data Length in Bytes: 16

Data Format: ASCII

Type: Block Read

Default Value: Part number/Die revision/Firmware revision

MFR_IOUT_OC_FAULT_RESPONSE (E5h)

Definition: Configures the I_{OUT} overcurrent fault response as defined by the following table. The command format is the same as the PMBus standard fault responses except that it sets the overcurrent status bit in STATUS_IOUT.

Data Length in Bytes: 1

Data Format: BIT

Type: R/W

Default Value: 80h (Disable, and no retry)

Units: N/A

SETTINGS	ACTIONS
80h	Disable with no retry.
BFh	Disable and continuous retry with 70ms delay.

MFR_IOUT_UC_FAULT_RESPONSE (E6h)

Definition: Configures the I_{OUT} undercurrent fault response as defined by the following table. The command format is the same as the PMBus standard fault responses except that it sets the undercurrent status bit in STATUS_IOUT.

Data Length in Bytes: 1

Data Format: BIT

Type: R/W

Default Value: 80h (Disable and no retry)

Units: N/A

SETTINGS	ACTIONS
80h	Disable with no retry.
BFh	Disable and continuous retry with 70ms delay.

SYNC_CONFIG (E9h)

Definition: This command is used to set options for SYNC output configurations.

Data Length in Bytes: 2

Data Format: BIT

Type: R/W

Default Value: 0000h

SETTINGS	ACTIONS
00h	Use Internal clock. Clock frequency is set by pin strap or PMBus command.
02h	Use internal clock and output internal clock.
04h	Use external clock.

ISL8270M

SNAPSHOT (EAh)

Definition: The SNAPSHOT command is a 32-byte read-back of parametric and status values. It allows monitoring and status data to be stored to flash following a fault condition. In case of a fault, last updated values are stored to the flash memory. When SNAPSHOT STATUS bit is set stored, device will no longer automatically capture parametric and status values following fault till stored data are erased. Use SNAPSHOT_CONTROL command to erase store data and clear the status bit before next ramp up. Data erased is not allowed when module is enabled.

Data Length in Bytes: 32

Data Format: Bit field

Type: Block Read

BYTE NUMBER	VALUE	PMBUS COMMAND	FORMAT
31:23	Reserved	Reserved	00h
22	Flash Memory Status Byte FF - Not Stored 00 - Stored	N/A	BIT
21	Manufacturer Specific Status Byte	STATUS_MFR_SPECIFIC (80h)	Byte
20	CML Status Byte	STATUS_CML (7Eh)	Byte
19	Temperature Status Byte	STATUS_TEMPERATURE (7Dh)	Byte
18	Input Status Byte	STATUS_INPUT (7Ch)	Byte
17	I _{OUT} Status Byte	STATUS_IOUT (7Bh)	Byte
16	V _{OUT} Status Byte	STATUS_VOUT (7Ah)	Byte
15:14	Switching Frequency	READ_FREQUENCY (95h)	L11
13:12	External Temperature	READ_EXTERNAL_TEMP (8Eh)	L11
11:10	Internal Temperature	READ_INTERNAL_TEMP (8Dh)	L11
9:8	Duty Cycle	READ_DUTY_CYCLE (94h)	L11
7:6	Highest Measured Output Current	N/A	L11
5:4	Output Current	READ_IOUT (8Ch)	L11
3:2	Output Voltage	READ_VOUT (8Bh)	L16u
1:0	Input Voltage	READ_VIN (88h)	L11

BLANK_PARAMS (EBh)

Definition: Returns a 16-byte string indicating which parameter values were either retrieved by the last RESTORE operation or have been written since that time. Reading BLANK_PARAMS immediately after a restore operation allows the user to determine which parameters are stored in that store. A one indicates the parameter is not present in the store and has not been written since the RESTORE operation.

Data Length in Bytes: 16

Data Format: BIT

Type: Block Read

Default Value: FF...FFh

SNAPSHOT_CONTROL (F3h)

Definition: SNAPSHOT_CONTROL command can be used to erase parametric and status values stored at SNAPSHOT, flash memory location.

Data Length in Bytes: 1

Data Format: Bit field

Type: R/W byte

VALUE	DESCRIPTION
03h	Erase parametric and status values stored in SNAPSHOT.

RESTORE_FACTORY (F4h)

Definition: Restores the device to the hard-coded Factory default values and pin strap definitions. The device retains the DEFAULT and USER stores for restoring. Security level is changed to Level 1 following this command.

Data Length in Bytes: 0

Data Format: N/A

Type: Write only

Default Value: N/A

Units: N/A

VDRV_OV_FAULT_LIMIT (F5h)

Definition: Reads the VDRV OV fault threshold.

Data Length in Bytes: 2

Data Format: L11

Type: Read only

Default Value: CB00h (6V)

Units:

Range: 4V to 6V

VDRV_UV_FAULT_LIMIT (F6h)

Definition: Reads the VDRV UV fault threshold

Data Length in Bytes: 2

Data Format: L11

Type: Read only

Default Value: CA00h (4V)

Units: V

Range: 4V to 6V

READ_VDRV (F7h)

Definition: Reads the VDRV voltage.

Data Length in Bytes: 2

Data Format: L11

Type: Read only

Default Value: N/A

Units: V

Range: 4V to 6V

VDRV_OV_FAULT_RESPONSE (F8h)

Definition: Reads the VDRV OV fault response

Data Length in Bytes: 1

Data Format: BIT

Type: Read only

Default Value: 80h (Disable and no retry)

Units:

VDRV_UV_FAULT_RESPONSE (F9h)

Definition: Reads the VDRV UV fault response

Data Length in Bytes: 1

Data Format: BIT

Type: Read only

Default Value: 80h (Disable and no retry)

Units: V

Revision History

The revision history provided is for informational purposes only and is believed to be accurate, but not warranted. Please go to web to make sure you have the latest revision.

DATE	REVISION	CHANGE
March 13, 2014	FN8635.0	Initial Release.

About Intersil

Intersil Corporation is a leading provider of innovative power management and precision analog solutions. The company's products address some of the largest markets within the industrial and infrastructure, mobile computing and high-end consumer markets.

For the most updated datasheet, application notes, related documentation and related parts, please see the respective product information page found at www.intersil.com.

You may report errors or suggestions for improving this datasheet by visiting www.intersil.com/ask.

Reliability reports are also available from our website at www.intersil.com/support

For additional products, see www.intersil.com/en/products.html

Intersil products are manufactured, assembled and tested utilizing ISO9001 quality systems as noted in the quality certifications found at www.intersil.com/en/support/qualandreliability.html

Intersil products are sold by description only. Intersil Corporation reserves the right to make changes in circuit design, software and/or specifications at any time without notice. Accordingly, the reader is cautioned to verify that data sheets are current before placing orders. Information furnished by Intersil is believed to be accurate and reliable. However, no responsibility is assumed by Intersil or its subsidiaries for its use; nor for any infringements of patents or other rights of third parties which may result from its use. No license is granted by implication or otherwise under any patent or patent rights of Intersil or its subsidiaries.

For information regarding Intersil Corporation and its products, see www.intersil.com

Package Outline Drawing Y40.17x19

40 I/O 17.0mm x 19.0mm x 3.55mm HDA MODULE

Rev 1, 2/14

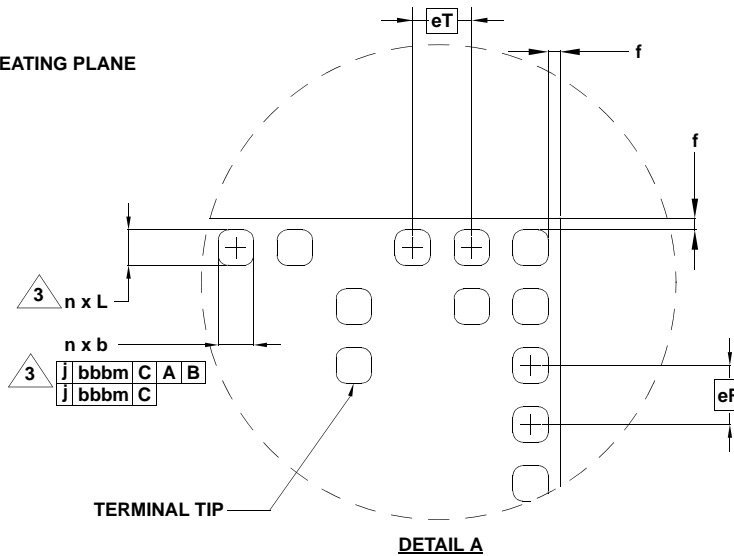
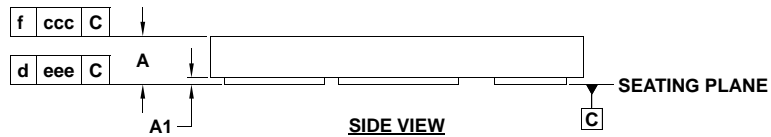
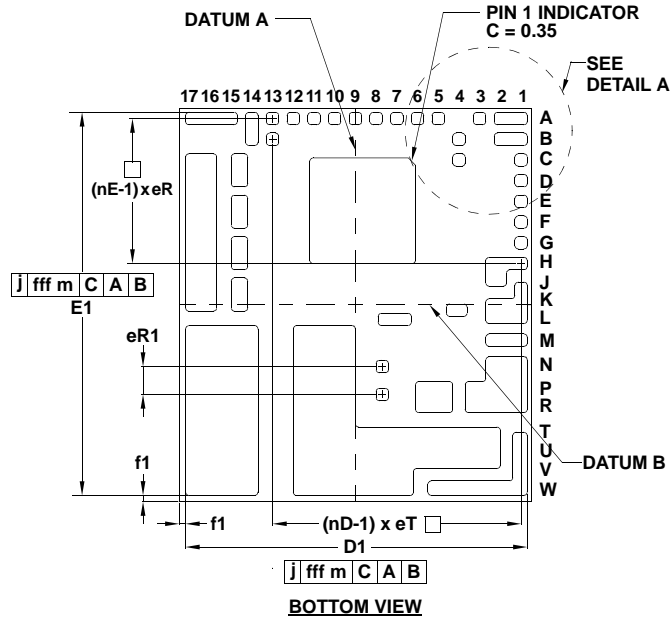
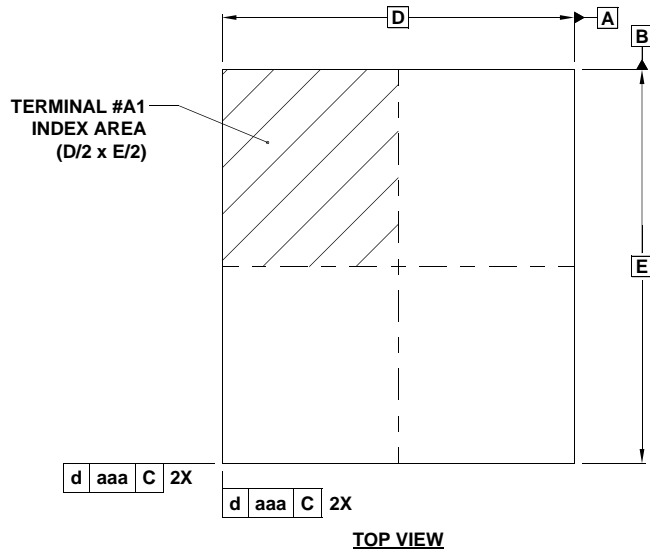

NOTES:

1. All dimensions are in millimeters.
2. 'eT' and 'eR' represent the basic land grid pitch.
3. "n" is the total number of I/O (excluding dummy pads).
4. Dimensioning and tolerancing per ASME Y14.5M-2009.
5. Tolerance for exposed DAP edge location dimension on page 3 is $\pm 0.1\text{mm}$.
6. Mold cap thickness: 3.40mm

DIMENSIONS			
SYMBOL	MIN	NOM	MAX
A	3.50	3.55	3.60
A1	-	-	0.025
b	0.55	0.60	0.65
L	0.55	0.60	0.65
eR	1.00 BSC		
eR1	1.35 BSC		
eT	1.00 BSC		
D	17.00 BSC		
D1	16.35	16.50	16.65
D2	2.40	2.50	2.60
D3	1.40	1.50	1.60
D4	0.70	0.80	0.90
D5	5.00	5.10	5.20
D6	0.90	1.00	1.10
D7	1.50	1.60	1.70
D8	0.90	1.00	1.10
D9	0.50	0.60	0.70
D10	3.40	3.50	3.60
D11	9.90	10.00	10.10
D12	2.90	3.00	3.10
D13	5.70	5.80	5.90
D14	1.70	1.80	1.90
D15	2.90	3.00	3.10
D16	1.90	2.00	2.10
D17	4.70	4.80	4.90
D18	0.60	0.70	0.80
D22	0.50	0.60	0.70
D23	1.50	1.60	1.70
E	19.00 BSC		
E1	18.35	18.50	18.65
E2	0.50	0.60	0.70
E3	7.50	7.60	7.70
E4	1.50	1.60	1.70
E5	5.00	5.10	5.20
E6	1.30	1.40	1.50
E7	0.50	0.60	0.70
E8	0.50	0.60	0.70
E9	0.70	0.80	0.90
E10	8.10	8.20	8.30
E11	8.10	8.20	8.30
E12	4.80	4.90	5.00
E13	1.90	2.00	2.10
E14	1.40	1.50	1.60
E15	2.60	2.70	2.80
E16	1.40	1.50	1.60
E17	2.95	3.05	3.15
E18	0.60	0.70	0.80
E19	1.90	2.00	2.10
E20	0.50	0.60	0.70
E21	0.50	0.60	0.70
E22	1.50	1.60	1.70
E23	0.50	0.60	0.70
f	0.20 REF		
f1	0.30 REF		
n	20		
nD	13		
nE	8		

ISL8270M

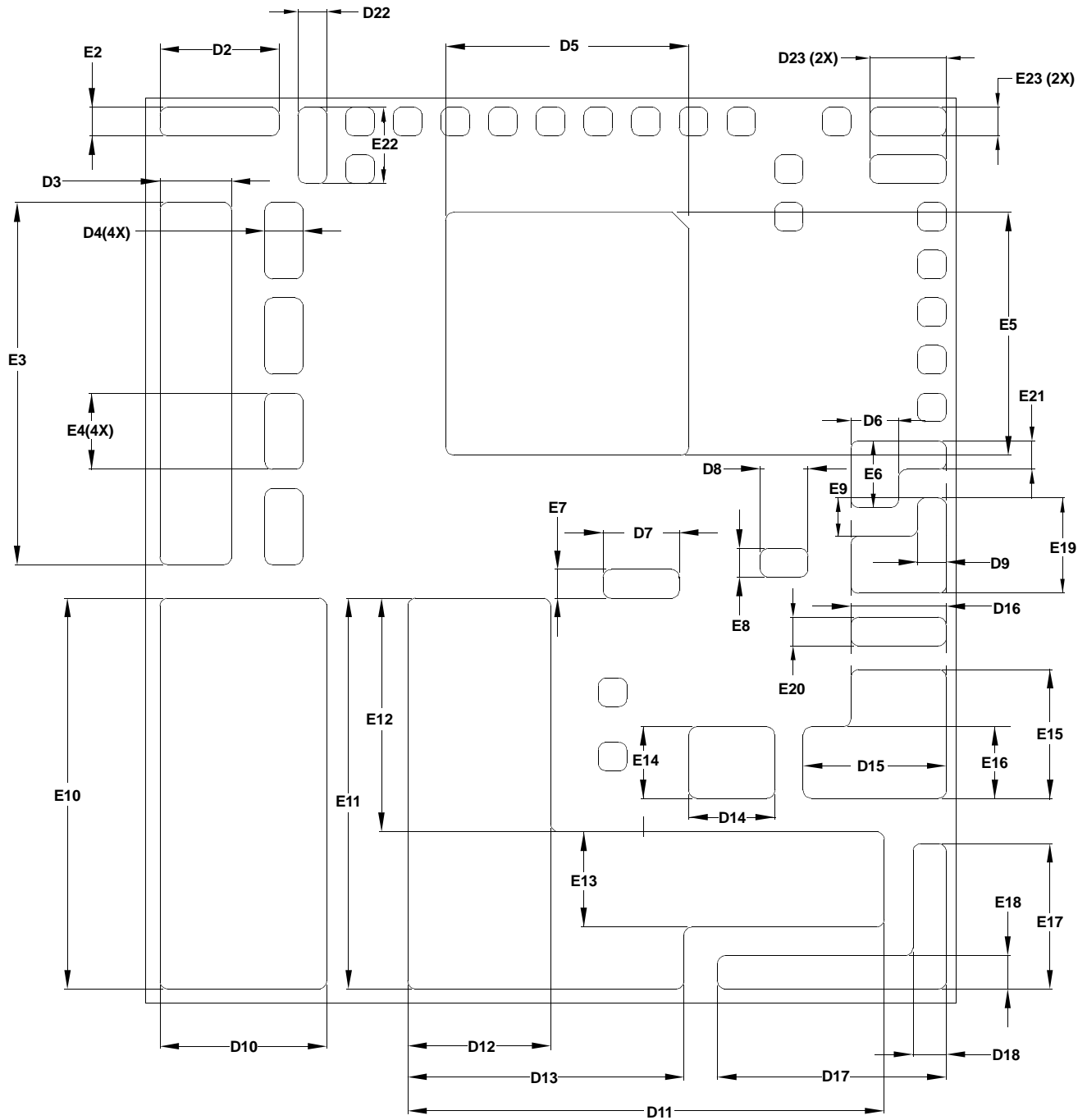

SIZE DETAILS FOR THE 16 EXPOSED DAPS
BOTTOM VIEW

ISL8270M

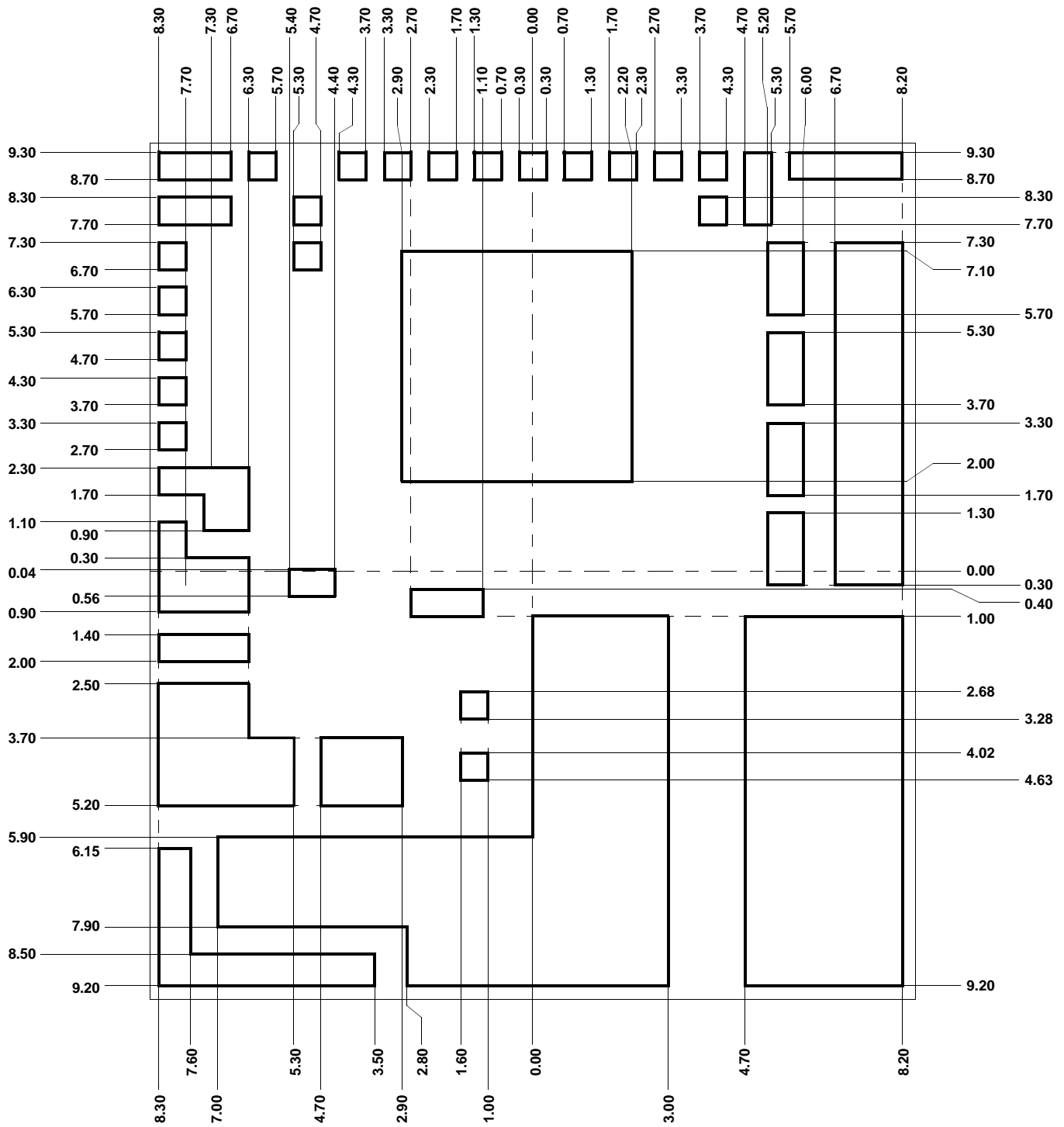

TYPICAL PCB LAND PATTERN (For Reference)

TOP VIEW

NOTE: All dimensions are in millimeters.

ISL8270M

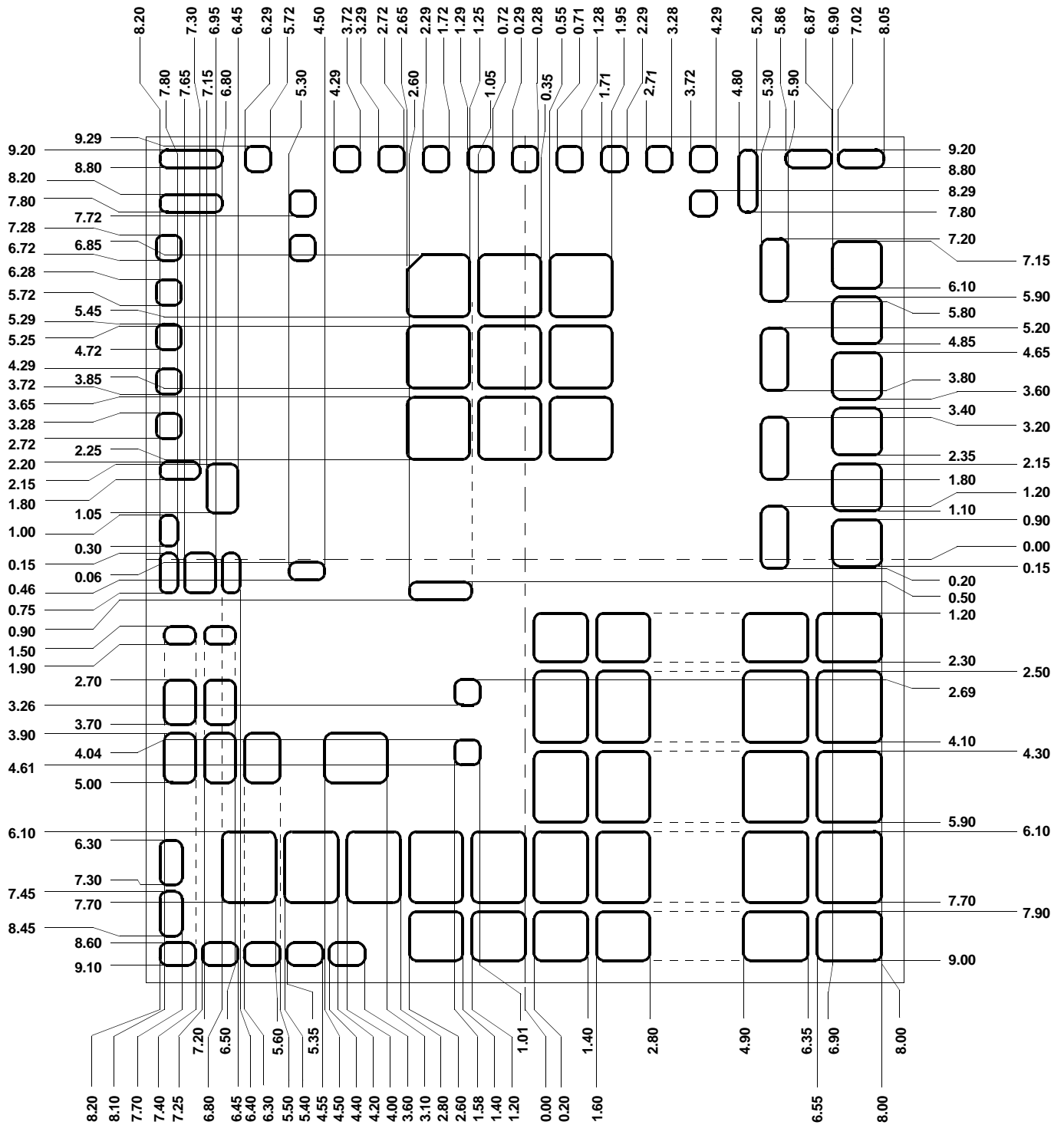

TYPICAL STENCIL OPENING EDGE POSITION (For Reference)

TOP VIEW

NOTE: All dimensions are in millimeters.