

ABR1S418B

output interface module - 17.5 mm -
electromechanical - 24 V AC/DC - 2 NO

Main

Range of product	Interface for discrete signals
Product or component type	Electromechanical output interface module
Contacts type and composition	2 NO
[Uc] control circuit voltage	24 V
Control circuit type	AC/DC
Control circuit frequency	50/60 Hz
Width pitch dimension	17.5 mm
[In] rated current	<= 55 mA AC <= 62 mA DC
Reverse polarity protection	With, circuit application: yes
Short circuit protection	16 A external fuse gF (Ik <= 2.5 kA AC and Ik <= 100 A DC) 16 A external fuse gG (Ik <= 2.5 kA AC and Ik <= 100 A DC)
[Ith] conventional free air thermal current	12 A conforming to IEC 60947-1
Local signalling	Green mechanical indicator for position of contacts and 1 green LED control signal state

Complementary

Control voltage limits	30 V energization threshold: 16.5 V
Maximum switching voltage	125 V DC
Housing colour	Grey
Connections - terminals	Screw clamp terminal
Drop-out voltage	<= 3.8 V
Holding current	>= 4.9 mA DC >= 5.2 mA AC
Power dissipation in W	<= 1.5 W
[Ue] rated operational voltage	<= 125 V DC conforming to IEC 60947-5-1 <= 230 V AC conforming to IEC 60947-5-1
Network frequency	50/60 Hz
[Ie] rated operational current	1 A AC-13 Ue: 230 V per 1000000 cycles conforming to IEC 60947-5-1 1 A AC-14 Ue: 230 V per 1000000 cycles conforming to IEC 60947-5-1 1 A AC-15 Ue: 230 V per 1000000 cycles conforming to IEC 60947-5-1 1 A DC-13 Ue: 24 V per 1000000 cycles conforming to IEC 60947-5-1 4 A AC-12 Ue: 230 V per 1000000 cycles conforming to IEC 60947-5-1 5 A DC-12 Ue: 24 V per 1000000 cycles conforming to IEC 60947-5-1
Minimum switching current	3 mA
Minimum switching voltage	17 V
Electrical reliability	<= 0.00000001
Operating time	<= 12 ms between de-energisation of coil and closing of NC contact <= 12 ms between de-energisation of coil and closing of NO contact <= 12 ms between energisation of coil and closing of NC contact <= 12 ms between energisation of coil and closing of NO contact
Contact bounce time	<= 3 ms
Operating rate in Hz	<= 6 Hz at no-load <= 0.5 Hz at le
Mechanical durability	>= 20000000 cycles
[Ui] rated insulation voltage	250 V conforming to IEC 60947-1 250 V conforming to VDE 0110 group C
Flame retardance	V0 conforming to UL 94
Cable cross section	0.27...4 mm ² , 1 wire rigid 0.34...2.5 mm ² , 1 or 2 wires flexible with cable end 0.6...2.5 mm ² , 1 or 2 wires flexible without cable end 0.27...2.5 mm ² , 2 wires rigid
Operating position	Any position

The information provided in this documentation contains general descriptions and/or technical characteristics of the performance of the products contained herein. This documentation is not intended as a substitute for and is not to be used for determining suitability or reliability of these products for specific user applications. It is the duty of any such user or integrator to perform the appropriate and complete risk analysis, evaluation and testing of the products with respect to the relevant specific application or use thereof. Neither Schneider Electric Industries SAS nor any of its affiliates or subsidiaries shall be responsible or liable for misuse of the information contained herein.

Installation category	II conforming to IEC 60947-1
Mounting support	Asymmetrical DIN rail Combination rail Symmetrical DIN rail
Product weight	0.095 kg

Environment

Immunity to microbreaks	8 ms
Dielectric strength	1500 V for 1 minute between independent contacts 2500 V for 1 minute between wired interface and earth 4000 V for 1 minute between coil circuit and contact circuits
Standards	IEC 60947-5-1
Product certifications	BV CSA DNV LROS (Lloyds register of shipping) UL
IP degree of protection	IP20 conforming to IEC 60529
Protective treatment	TC
Fire resistance	850 °C conforming to IEC 60695-2-1
Shock resistance	50 gn for 11 ms conforming to IEC 60068-2-27
Vibration resistance	6 gn (f = 10...55 Hz) conforming to IEC 60068-2-6
Electromagnetic compatibility	1.2/50 ms shock waves immunity test, 0.25 kV for U > 50 V conforming to IEC 255-4 1.2/50 ms shock waves immunity test, 0.5 kV for U < 50 V conforming to IEC 255-4 Electrostatic discharge immunity test level 3, 8 kV conforming to IEC 61000-4-2 Rapid transients immunity test, on input/output 1 kV conforming to IEC 61000-4-4 Rapid transients immunity test, on power supply 2 kV conforming to IEC 61000-4-4
Ambient air temperature for operation	-20...60 °C at Un -5...40 °C unrestricted operation
Ambient air temperature for storage	-40...70 °C
Operating altitude	<= 3000 m
Pollution degree	3 conforming to IEC 60947-5-1

Electromechanical Interface Module

Dimensions

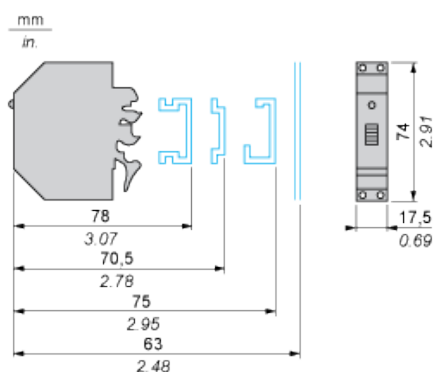

Electromechanical Interface Module

Example of Application with PLC

Interfacing PLC discrete outputs

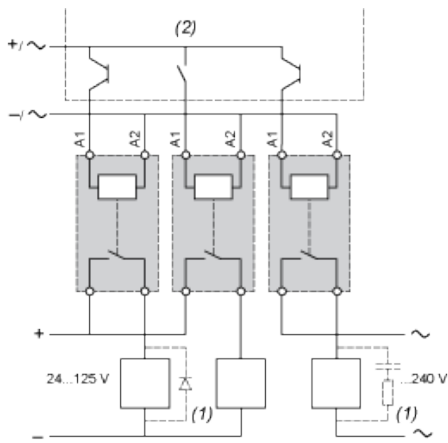

- (1) Essential on inductive loads (can be replaced with peak limiter)
- (2) PLC positive logic transistor (or relay) outputs

Interface with Mechanical Indication + LED

Circuit Diagram

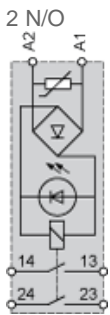

Electrical Durability of Contacts

AC Loads

Test conditions: in accordance with standard IEC 947-5-1 set up for rated control voltage, operating rate: 1800 cycles/hour. (0.5 Hz).

AC-12 operating cycles in millions

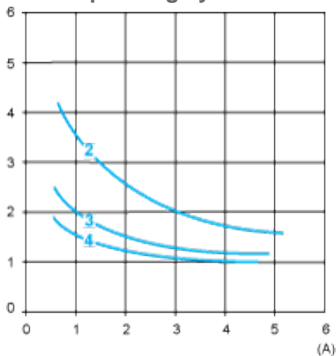

AC- Control of resistive loads and isolated solid state loads via optocoupler ($\cos \phi \geq 0.9$)

12

- (1) 24 V
- (2) 48 V
- (3) 127 V
- (4) 230 V

AC-13 operating cycles in millions

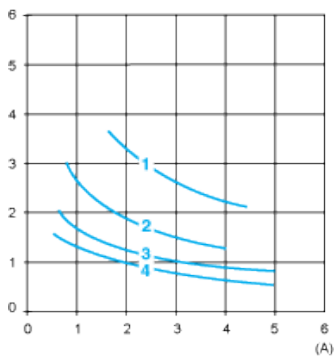

AC- Control of isolated solid state loads via transformer ($\cos \phi \geq 0.65$)

13

- (1) 24 V
- (2) 48 V
- (3) 127 V
- (4) 230 V

AC-14 and AC-15 operating cycles in millions

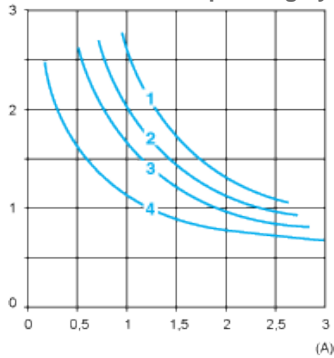

AC- Control of weak electromagnetic loads of electromagnets ≤ 72 VA (make: $\cos \phi = 0.3$, break: $\cos \phi = 0.3$)

14

AC- Control of electromagnetic loads of electromagnets > 72 VA (make: $\cos \phi = 0.7$, break: $\cos \phi = 0.4$)

15

- (1) 24 V
- (2) 48 V
- (3) 127 V
- (4) 230 V

DC Loads

Test conditions: in accordance with standard IEC 947-5-1 set up for rated control voltage, operating rate: 1800 cycles/hour. (0.5 Hz).

DC-12 operating cycles in millions

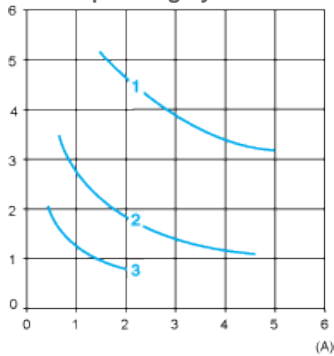

DC- Control of resistive loads and isolated solid state loads via optocoupler ($L/R \leq 1$ ms)

12

- (1) 24 V
- (2) 48 V
- (3) 127 V

DC-13 operating cycles in millions

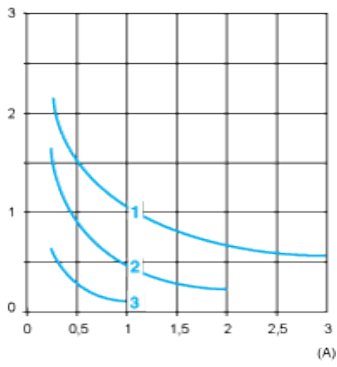

DC- Control of electromagnets ($L/R \leq 2 \times (U_e \times I_e)$ in ms, with U_e : rated operating voltage and I_e : rated operating current)
 13

- (1) 24 V
- (2) 48 V
- (3) 127 V