

Analog Devices Welcomes Hittite Microwave Corporation

NO CONTENT ON THE ATTACHED DOCUMENT HAS CHANGED



THIS PAGE INTENTIONALLY LEFT BLANK



HMC321LP4 / 321LP4E

GaAs MMIC SP8T NON-REFLECTIVE POSITIVE CONTROL SWITCH, DC* - 8 GHz

Typical Applications

This switch is suitable for usage in DC - 8.0 GHz 50-Ohm or 75-Ohm systems:

- Broadband
- Fiber Optics
- Switched Filter Banks
- Wireless below 8 GHz

Features

Broadband Performance: DC - 8 GHz

High Isolation: >30 dB@ 6 GHz

Low Insertion Loss: 2.5 dB@ 6 GHz

Integrated Positive Supply 3:8 TTL Decoder

4x4 mm SMT Package

Functional Diagram

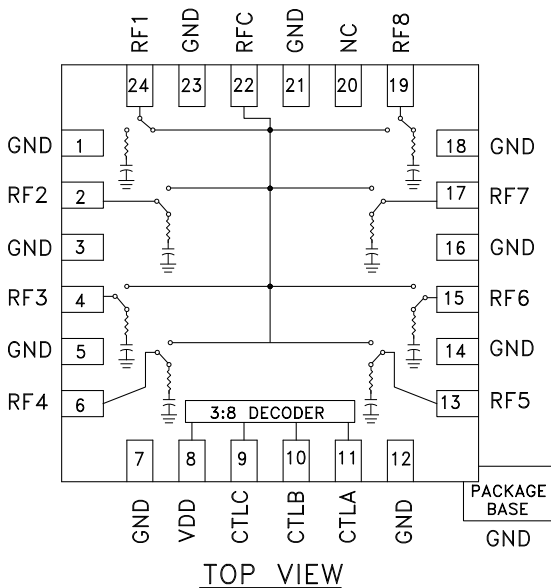

General Description

The HMC321LP4 & HMC321LP4E are broadband non-reflective GaAs MESFET SP8T switches in low cost leadless surface mount packages. Covering DC to 8 GHz, this switch offers high isolation and low insertion loss. This switch also includes an on board binary decoder circuit which reduces the required logic control lines to three. The switch operates using a positive control voltage of 0/+5 volts, and requires a fixed bias of +5v. This switch is suitable for usage in 50-Ohm or 75-Ohm systems.

* DC blocking capacitors are required at ports RFC and RF1, 2, 3, 4, 5, 6, 7, 8. Their value will determine the lowest transmission frequency.

Electrical Specifications, $T_A = +25^\circ C$, With 0/+5V Control, 50 Ohm System

| Parameter | Frequency | Min. | Typ. | Max. | Units |
|---|---------------|----------------------------------|------|------|-------|
| Insertion Loss | DC - 2.0 GHz | | 2.3 | 2.7 | dB |
| | DC - 4.0 GHz | | 2.5 | 2.9 | dB |
| | DC - 8.0 GHz | | 2.7 | 3.1 | dB |
| Isolation | DC - 2.0 GHz | 35 | 40 | | dB |
| | DC - 4.0 GHz | 30 | 35 | | dB |
| | DC - 6.0 GHz | 25 | 30 | | dB |
| | DC - 8.0 GHz | 20 | 25 | | dB |
| Return Loss | "On State" | DC - 4.0 GHz | 8 | 12 | dB |
| | | DC - 8.0 GHz | 7 | 10 | dB |
| Return Loss (RF1 - RF8) | "Off State" | 2.0 - 8.0 GHz | 7 | 12 | dB |
| Input Power for 1 dB Compression | 0.5 - 8.0 GHz | 19 | 23 | | dBm |
| Input Third Order Intercept (Two-tone Input Power = +7 dBm Each Tone, 1 MHz Spacing) | 0.5 - 8.0 GHz | 33 | 40 | | dBm |
| Switching Characteristics | DC - 8.0 GHz | tRISE, tFALL (10/90% RF) | | 50 | ns |
| | | tON, tOFF (50% CTL to 10/90% RF) | | 150 | ns |
| | | | | | |

For price, delivery, and to place orders, please contact Hittite Microwave Corporation:
 20 Alpha Road, Chelmsford, MA 01824 Phone: 978-250-3343 Fax: 978-250-3373
 Order On-line at www.hittite.com

Insertion Loss vs. Temperature

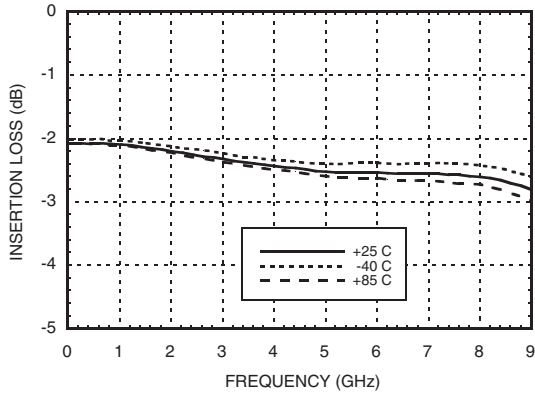

Isolation

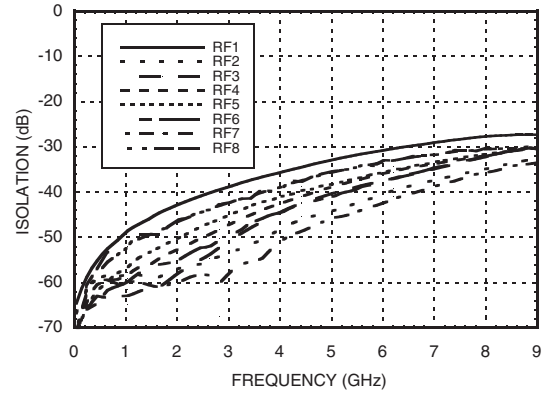

Return Loss

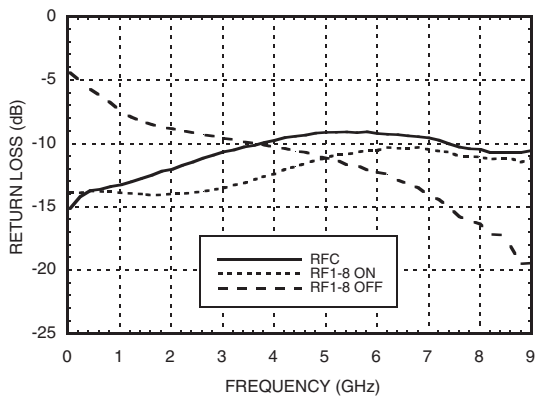

0.1 and 1 dB Input Compression Point

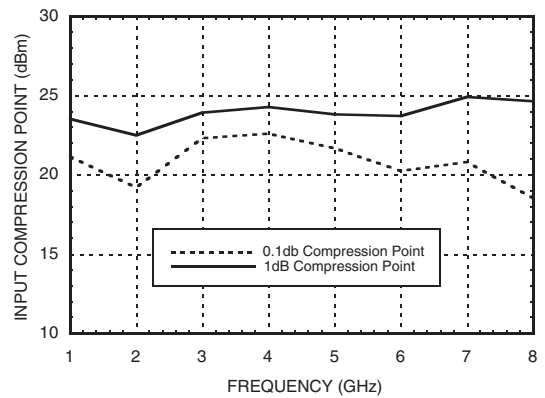

Input Third Order Intercept Point

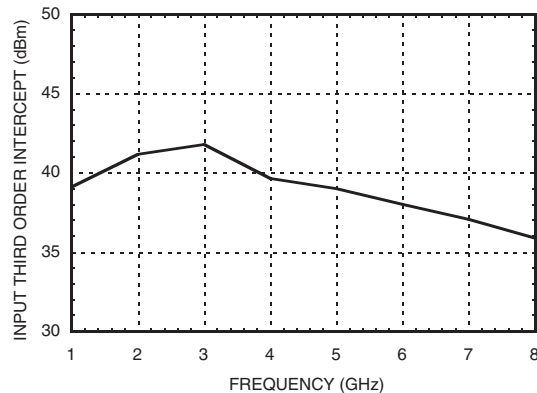



GaAs MMIC SP8T NON-REFLECTIVE POSITIVE CONTROL SWITCH, DC* - 8 GHz

Bias Voltage & Current

| Vdd Range = +5.0 Vdc ± 10% | | |
|----------------------------|-----------------|-----------------|
| Vdd (Vdc) | Idd (Typ.) (mA) | Idd (Max.) (mA) |
| +5.0 | 5.0 | 9.0 |

Control Voltages

| State | Bias Condition |
|-------|----------------------------------|
| Low | 0 to +0.8 Vdc @ 5 uA Typical |
| High | +2.0 to +5.0 Vdc @ 25 uA Typical |

Truth Table

| Control Input | | | Signal Path State |
|---------------|------|------|-------------------|
| A | B | C | RFCOM to: |
| Low | Low | Low | RF1 |
| High | Low | Low | RF2 |
| Low | High | Low | RF3 |
| High | High | Low | RF4 |
| Low | Low | High | RF5 |
| High | Low | High | RF6 |
| Low | High | High | RF7 |
| High | High | High | RF8 |

Note:

DC blocking capacitors are required at ports RFC and RF1, 2, 3, 4, 5, 6, 7, 8. Their value will determine the lowest transmission frequency.

Absolute Maximum Ratings

| | |
|-----------------------------------|-----------------------|
| Bias Voltage Range (Port Vdd) | +7.0 Vdc |
| Control Voltage Range (A, B, & C) | -0.5V to Vdd +1.0 Vdc |
| Storage Temperature | -65 to +150 °C |
| Operating Temperature | -40 to +85 °C |
| Maximum Input Power Vdd = +5V | +26 dBm |
| ESD Sensitivity (HBM) | Class 1A |



ELECTROSTATIC SENSITIVE DEVICE
OBSERVE HANDLING PRECAUTIONS

Outline Drawing

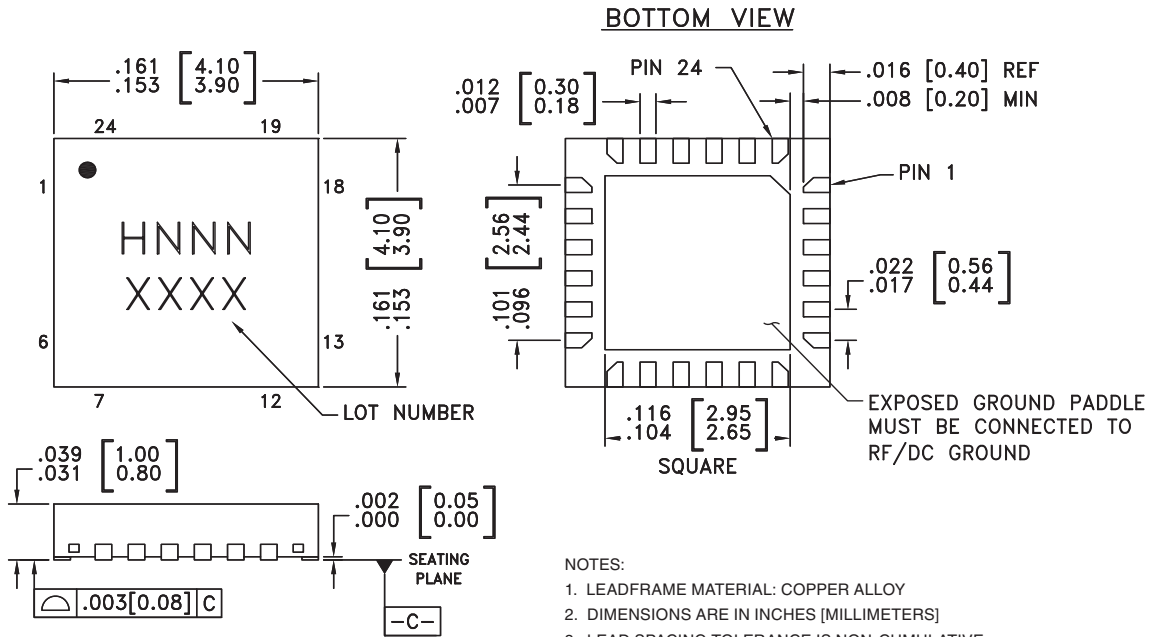

NOTES:

- LEADFRAME MATERIAL: COPPER ALLOY
- DIMENSIONS ARE IN INCHES [MILLIMETERS]
- LEAD SPACING TOLERANCE IS NON-CUMULATIVE.
- PAD BURR LENGTH SHALL BE 0.15mm MAXIMUM.
PAD BURR HEIGHT SHALL BE 0.05mm MAXIMUM.
- PACKAGE WARP SHALL NOT EXCEED 0.05mm.
- ALL GROUND LEADS AND GROUND PADDLE MUST BE SOLDERED TO PCB RF GROUND.
- REFER TO HITTITE APPLICATION NOTE FOR SUGGESTED LAND PATTERN.

Package Information

| Part Number | Package Body Material | Lead Finish | MSL Rating | Package Marking ^[3] |
|-------------|--|---------------|---------------------|--------------------------------|
| HMC321LP4 | Low Stress Injection Molded Plastic | Sn/Pb Solder | MSL1 ^[1] | H321 XXXX |
| HMC321LP4E | RoHS-compliant Low Stress Injection Molded Plastic | 100% matte Sn | MSL1 ^[2] | H321 XXXX |

[1] Max peak reflow temperature of 235 °C

[2] Max peak reflow temperature of 260 °C

[3] 4-Digit lot number XXXX

For price, delivery, and to place orders, please contact Hittite Microwave Corporation:
20 Alpha Road, Chelmsford, MA 01824 Phone: 978-250-3343 Fax: 978-250-3373
Order On-line at www.hittite.com

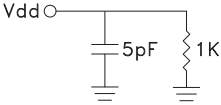
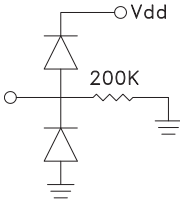

Pin Descriptions

| Pin Number | Function | Description | Interface Schematic |
|------------------------------------|-----------------|---|--|
| 1, 3, 5, 7, 12, 14, 16, 18, 21, 23 | GND | Package bottom has exposed metal paddle that must also be connected to PCB RF ground. |  |
| 2, 4, 6, 13, 15, 17, 19, 22, 24 | RF1 - RF8 & RFC | This pin is DC coupled and matched to 50 Ohm. Blocking capacitors are required. | |
| 8 | VDD | Supply Voltage +5V ± 10% |  |
| 9 | CTLC | See truth table and control voltage table. |  |
| 10 | CTLB | See truth table and control voltage table. | |
| 11 | CTLA | See truth table and control voltage table. | |
| 20 | N/C | This pin should be connected to PCB RF ground to maximize isolation. | |

Evaluation PCB

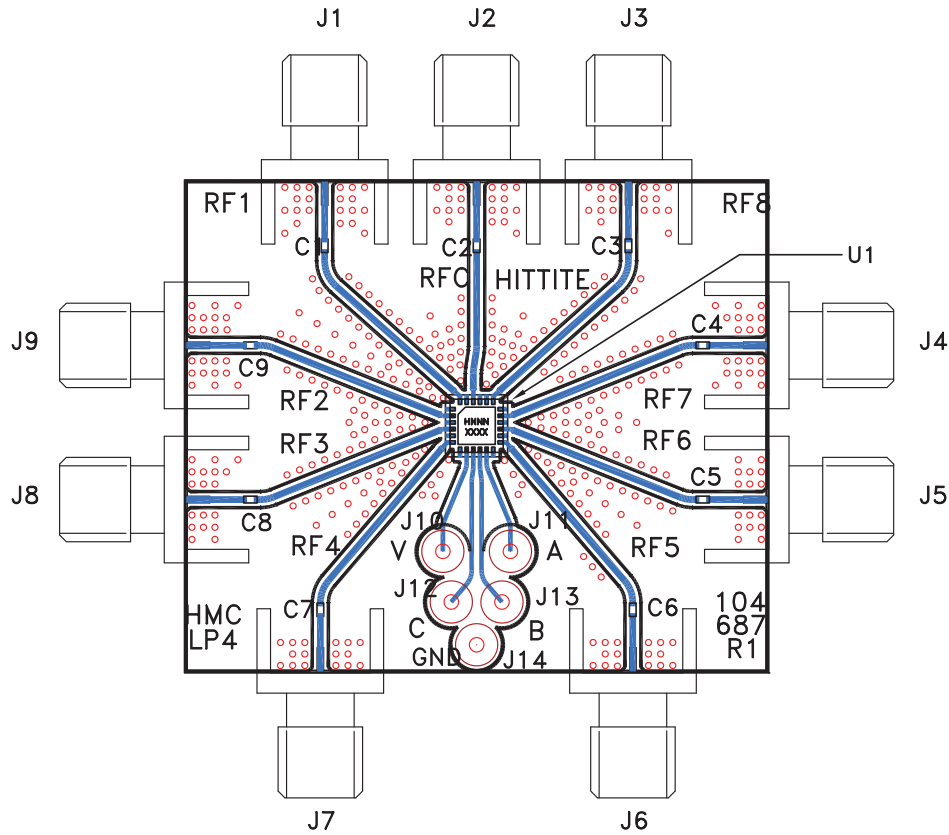

List of Materials for Evaluation PCB 104769 [1]

| Item | Description |
|-----------|-------------------------------------|
| J1 - J9 | PCB Mount SMA RF Connector |
| J10 - J14 | DC Pin |
| C1 - C9 | 100 pF Capacitor, 0402 Pkg. |
| U1 | HMC321LP4 / HMC321LP4E SP8T Switch |
| PCB [2] | 104687 Evaluation PCB 1.73" x 1.46" |

[1] Reference this number when ordering complete evaluation PCB

[2] Circuit Board Material: Rogers 4350

The circuit board used in the final application should be generated with proper RF circuit design techniques. Signal lines at the RF port should have 50 ohm impedance and the package ground leads and backside ground slug should be connected directly to the ground plane similar to that shown above. The evaluation circuit board shown above is available from Hittite Microwave Corporation upon request.