



October 2014

MOC205M, MOC206M, MOC207M, MOC211M, MOC212M, MOC213M, MOC216M, MOC217M 8-pin SOIC Single-Channel Phototransistor Output Optocoupler

Features

- Closely Matched Current Transfer Ratios
- Minimum BV_{CEO} of 70 V Guaranteed
 - MOC205M, MOC206M, MOC207M
- Minimum BV_{CEO} of 30 V Guaranteed
 - MOC211M, MOC212M, MOC213M, MOC216M, MOC217M
- Low LED Input Current Required for Easier Logic Interfacing
 - MOC216M, MOC217M
- Convenient Plastic SOIC-8 Surface Mountable Package Style, with 0.050" Lead Spacing
- Safety and Regulatory Approvals:
 - UL1577, 2,500 $V_{AC_{RMS}}$ for 1 Minute
 - DIN-EN/IEC60747-5-5, 565 V Peak Working Insulation Voltage

Applications

- Feedback Control Circuits
- Interfacing and Coupling Systems of Different Potentials and Impedances
- General Purpose Switching Circuits
- Monitor and Detection Circuits

Description

These devices consist of a gallium arsenide infrared emitting diode optically coupled to a monolithic silicon phototransistor detector, in a surface mountable, small outline, plastic package. They are ideally suited for high-density applications, and eliminate the need for through-the-board mounting.

Schematic

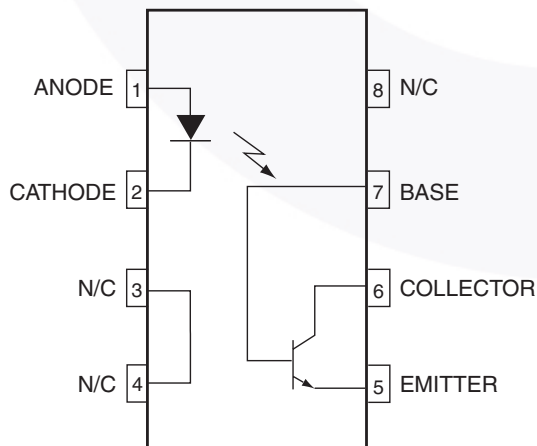

Figure 1. Schematic

Package Outline

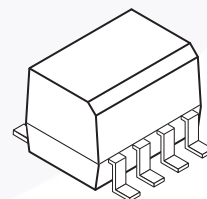

Figure 2. Package Outline

MOC20xM, MOC21xM — 8-pin SOIC Single-Channel Phototransistor Output Optocoupler

Safety and Insulation Ratings

As per DIN EN/IEC 60747-5-5, this optocoupler is suitable for “safe electrical insulation” only within the safety limit data. Compliance with the safety ratings shall be ensured by means of protective circuits.

Parameter		Characteristics
Installation Classifications per DIN VDE 0110/1.89 Table 1, For Rated Mains Voltage	< 150 V _{RMS}	I–IV
	< 300 V _{RMS}	I–III
Climatic Classification		55/100/21
Pollution Degree (DIN VDE 0110/1.89)		2
Comparative Tracking Index		175

Symbol	Parameter	Value	Unit
V _{PR}	Input-to-Output Test Voltage, Method A, V _{IORM} × 1.6 = V _{PR} , Type and Sample Test with t _m = 10 s, Partial Discharge < 5 pC	904	V _{peak}
	Input-to-Output Test Voltage, Method B, V _{IORM} × 1.875 = V _{PR} , 100% Production Test with t _m = 1 s, Partial Discharge < 5 pC	1060	V _{peak}
V _{IORM}	Maximum Working Insulation Voltage	565	V _{peak}
V _{IOTM}	Highest Allowable Over-Voltage	4000	V _{peak}
	External Creepage	≥ 4	mm
	External Clearance	≥ 4	mm
DTI	Distance Through Insulation (Insulation Thickness)	≥ 0.4	mm
T _S	Case Temperature ⁽¹⁾	150	°C
I _{S,INPUT}	Input Current ⁽¹⁾	200	mA
P _{S,OUTPUT}	Output Power ⁽¹⁾	300	mW
R _{IO}	Insulation Resistance at T _S , V _{IO} = 500 V ⁽¹⁾	> 10 ⁹	Ω

Note:

1. Safety limit values – maximum values allowed in the event of a failure.

Absolute Maximum Ratings

Stresses exceeding the absolute maximum ratings may damage the device. The device may not function or be operable above the recommended operating conditions and stressing the parts to these levels is not recommended. In addition, extended exposure to stresses above the recommended operating conditions may affect device reliability. The absolute maximum ratings are stress ratings only. $T_A = 25^\circ\text{C}$ unless otherwise specified.

Symbol	Rating	Value	Unit
TOTAL DEVICE			
T_{STG}	Storage Temperature	-40 to +125	$^\circ\text{C}$
T_A	Ambient Operating Temperature	-40 to +100	$^\circ\text{C}$
T_J	Junction Temperature	-40 to +125	$^\circ\text{C}$
T_{SOL}	Lead Solder Temperature	260 for 10 seconds	$^\circ\text{C}$
P_D	Total Device Power Dissipation @ $T_A = 25^\circ\text{C}$	240	mW
	Derate above 25°C	2.94	mW/ $^\circ\text{C}$
EMITTER			
I_F	Continuous Forward Current	60	mA
I_F (pk)	Forward Current – Peak (PW = 100 μs , 120 pps)	1.0	A
V_R	Reverse Voltage	6.0	V
P_D	LED Power Dissipation @ $T_A = 25^\circ\text{C}$	90	mW
	Derate above 25°C	0.8	mW/ $^\circ\text{C}$
DETECTOR			
I_C	Continuous Collector Current	150	mA
V_{CEO}	Collector-Emitter Voltage	30	V
V_{ECO}	Emitter-Collector Voltage	7	V
P_D	Detector Power Dissipation @ $T_A = 25^\circ\text{C}$	150	mW
	Derate above 25°C	1.76	mW/ $^\circ\text{C}$

Electrical Characteristics

$T_A = 25^\circ\text{C}$ unless otherwise specified.

Symbol	Parameter	Test Conditions	Min.	Typ.	Max.	Unit
EMITTER						
V_F	Input Forward Voltage MOC216M, MOC217M	$I_F = 1\text{ mA}$		1.07	1.3	V
	MOC205M, MOC206M, MOC207M MOC211M, MOC212M, MOC213M	$I_F = 10\text{ mA}$		1.15	1.5	V
I_R	Reverse Leakage Current	$V_R = 6\text{ V}$		0.001	100	μA
C_{IN}	Input Capacitance			18		pF
DETECTOR						
I_{CEO1}	Collector-Emitter Dark Current	$V_{CE} = 10\text{ V}, T_A = 25^\circ\text{C}$		1.0	50	nA
I_{CEO2}		$V_{CE} = 10\text{ V}, T_A = 100^\circ\text{C}$		1.0		μA
BV_{CEO}	Collector-Emitter Breakdown Voltage MOC205M, MOC206M, MOC207M	$I_C = 100\text{ }\mu\text{A}$	70	100		V
	MOC211M, MOC212M, MOC213M, MOC216M, MOC217M	$I_C = 100\text{ }\mu\text{A}$	30	100		V
BV_{CBO}	Collector-Base Breakdown Voltage	$I_C = 10\text{ }\mu\text{A}$	70	120		V
BV_{ECO}	Emitter-Collector Breakdown Voltage	$I_E = 100\text{ }\mu\text{A}$	7	10		V
C_{CE}	Collector-Emitter Capacitance	$f = 1.0\text{ MHz}, V_{CE} = 0$		7		pF
COUPLED						
CTR	Collector-Output Current MOC205M	$I_F = 10\text{ mA}, V_{CE} = 10\text{ V}$	40		80	%
	MOC206M	$I_F = 10\text{ mA}, V_{CE} = 10\text{ V}$	63		125	%
	MOC207M	$I_F = 10\text{ mA}, V_{CE} = 10\text{ V}$	100		200	%
	MOC211M	$I_F = 10\text{ mA}, V_{CE} = 10\text{ V}$	20			%
	MOC212M	$I_F = 10\text{ mA}, V_{CE} = 10\text{ V}$	50			%
	MOC213M	$I_F = 10\text{ mA}, V_{CE} = 10\text{ V}$	100			%
	MOC216M	$I_F = 1\text{ mA}, V_{CE} = 5\text{ V}$	50			%
	MOC217M	$I_F = 1\text{ mA}, V_{CE} = 5\text{ V}$	100			%
$V_{CE(SAT)}$	Collector-Emitter Saturation Voltage MOC205M, MOC206M, MOC207M MOC211M, MOC212M, MOC213M	$I_C = 2\text{ mA}, I_F = 10\text{ mA}$			0.4	V
	MOC216M, MOC217M	$I_C = 100\text{ }\mu\text{A}, I_F = 1\text{ mA}$			0.4	V
t_{on}	Turn-On Time	$I_C = 2\text{ mA}, V_{CC} = 10\text{ V},$ $R_L = 100\text{ }\Omega$ (Figure 12)		7.5		μs
t_{off}	Turn-Off Time	$I_C = 2\text{ mA}, V_{CC} = 10\text{ V},$ $R_L = 100\text{ }\Omega$ (Figure 12)		5.7		μs
t_r	Rise Time	$I_C = 2\text{ mA}, V_{CC} = 10\text{ V},$ $R_L = 100\text{ }\Omega$ (Figure 12)		3.2		μs
t_f	Fall Time	$I_C = 2\text{ mA}, V_{CC} = 10\text{ V},$ $R_L = 100\text{ }\Omega$ (Figure 12)		4.7		μs

Isolation Characteristics

Symbol	Characteristic	Test Conditions	Min.	Typ.	Max.	Units
V_{ISO}	Input-Output Isolation Voltage	$t = 1 \text{ Minute}$	2500			$V_{AC_{RMS}}$
C_{ISO}	Isolation Capacitance	$V_{I-O} = 0 \text{ V}, f = 1 \text{ MHz}$		0.2		pF
R_{ISO}	Isolation Resistance	$V_{I-O} = \pm 500 \text{ VDC}, T_A = 25^\circ\text{C}$	10^{11}			Ω



Typical Performance Curves

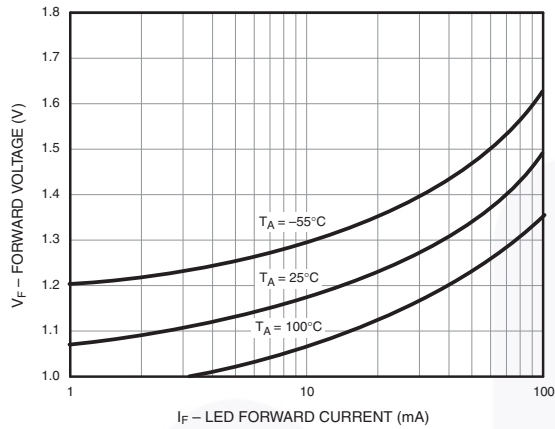

Figure 3. LED Forward Voltage vs. Forward Current

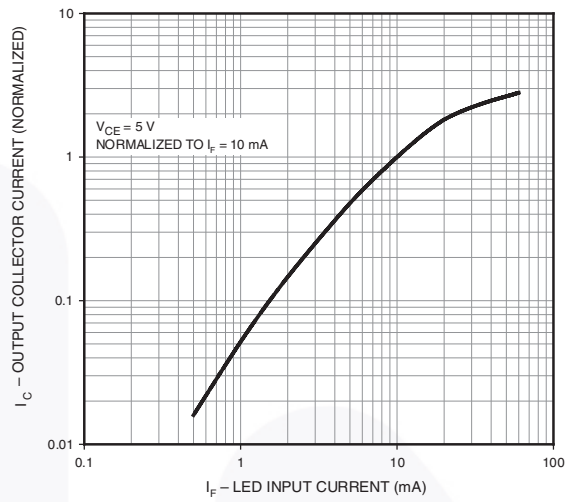

Figure 4. Output Current vs. Input Current

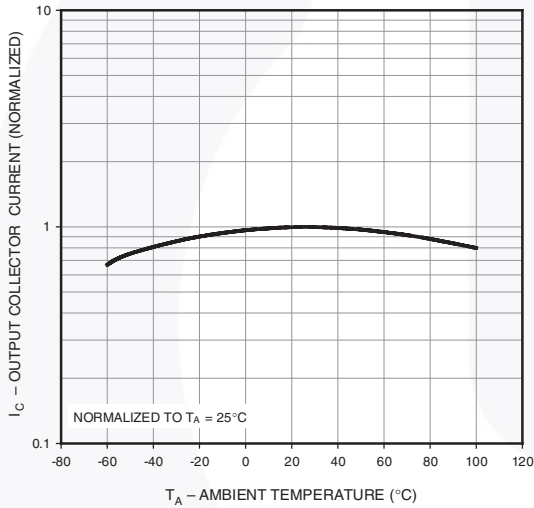

Figure 5. Output Current vs. Ambient Temperature

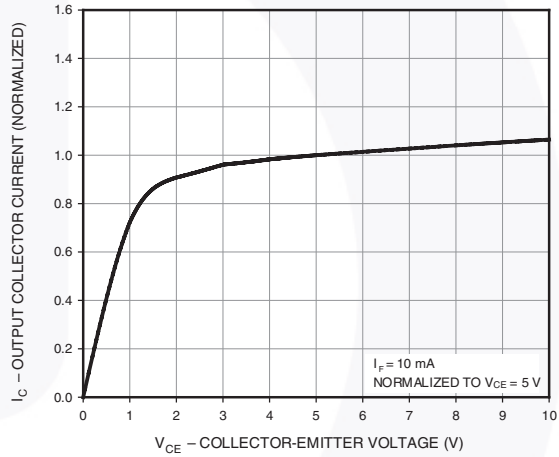

Figure 6. Output Current vs. Collector-Emitter Voltage

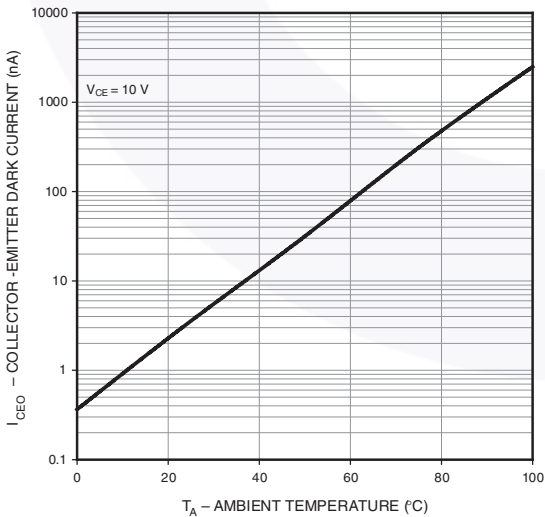

Figure 7. Dark Current vs. Ambient Temperature

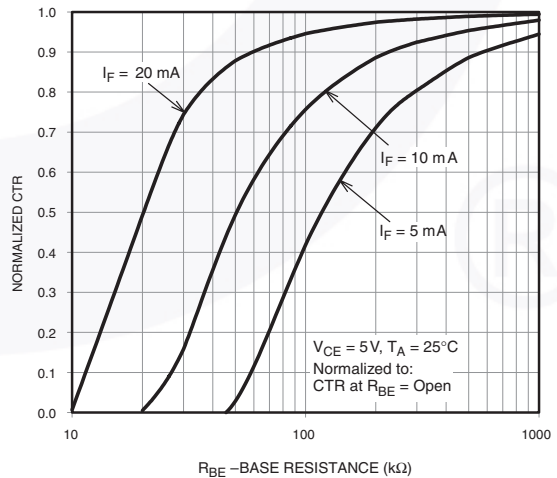

Figure 8. CTR vs. RBE (Unsaturated)

Typical Performance Curves (Continued)

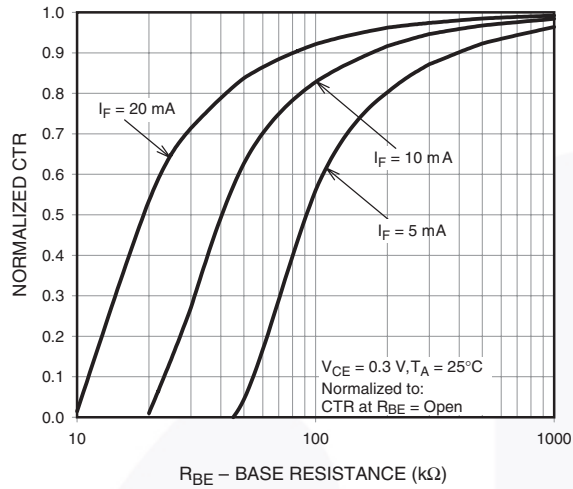

Figure 9. CTR vs. RBE (Saturated)

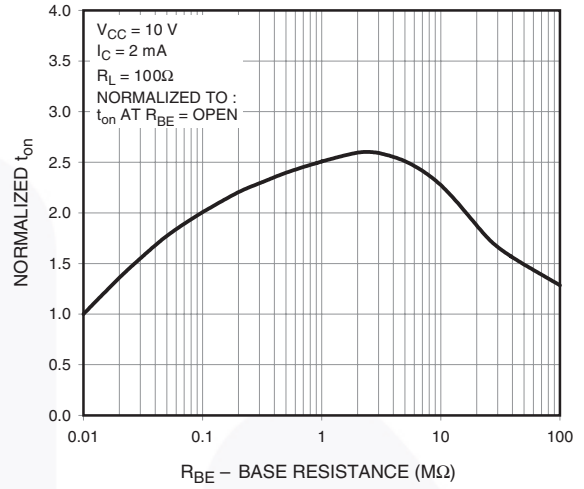

Figure 10. Normalized ton vs. RBE

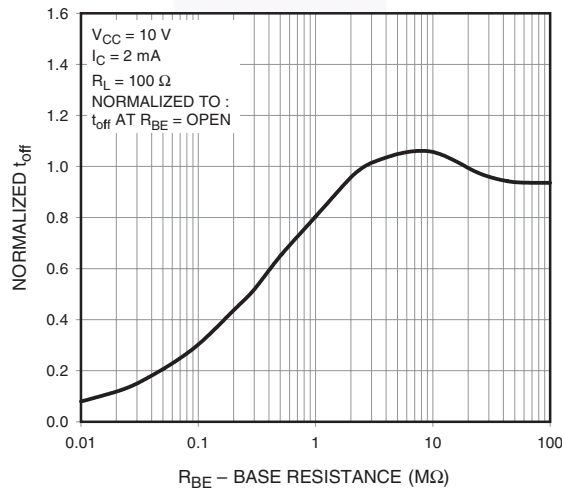

Figure 11. Normalized toff vs. RBE

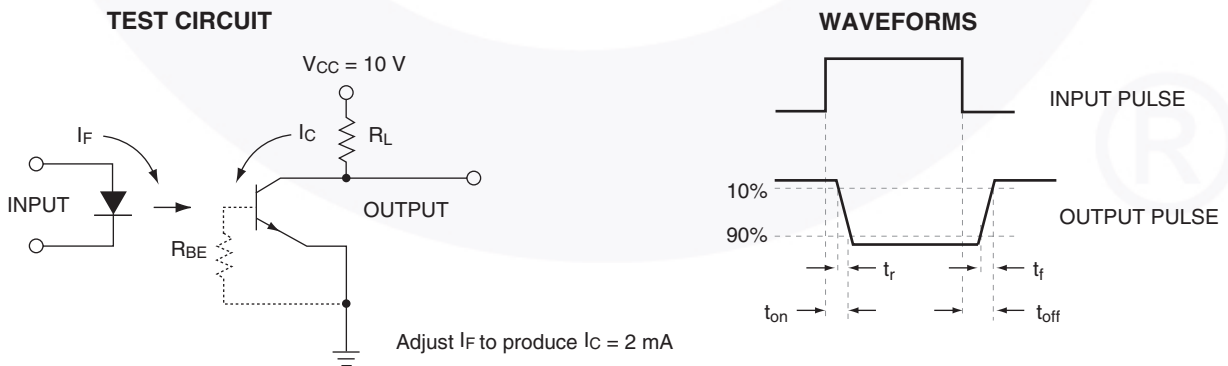

Figure 12. Switching Time Test Circuit and Waveforms

Reflow Profile

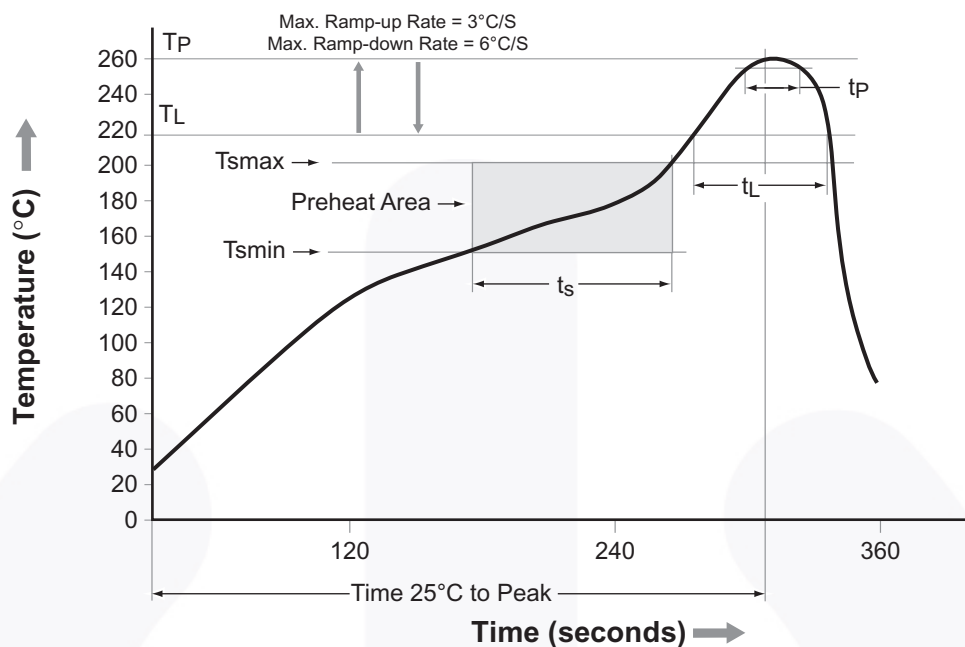

Figure 13. Reflow Profile

Profile Feature	Pb-Free Assembly Profile
Temperature Minimum (T_{smin})	150°C
Temperature Maximum (T_{smax})	200°C
Time (t_s) from (T_{smin} to T_{smax})	60–120 seconds
Ramp-up Rate (t_L to t_p)	3°C/second maximum
Liquidous Temperature (T_L)	217°C
Time (t_L) Maintained Above (T_L)	60–150 seconds
Peak Body Package Temperature	260°C +0°C / -5°C
Time (t_p) within 5°C of 260°C	30 seconds
Ramp-down Rate (T_P to T_L)	6°C/second maximum
Time 25°C to Peak Temperature	8 minutes maximum

Ordering Information

Part Number	Package	Packing Method
MOC205M	Small Outline 8-Pin	Tube (100 Units)
MOC205R2M	Small Outline 8-Pin	Tape and Reel (1000 Units)
MOC205VM	Small Outline 8-Pin, DIN EN/IEC60747-5-5 Option	Tube (100 Units)
MOC205R2VM	Small Outline 8-Pin, DIN EN/IEC60747-5-5 Option	Tape and Reel (1000 Units)

Note:

2. The product orderable part number system listed in this table also applies to the MOC20XM and MOC21XM products.

Marking Information

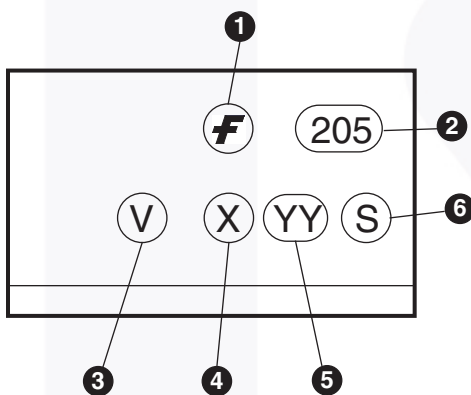

Figure 14. Top Mark

Table 1. Top Mark Definitions

1	Fairchild Logo
2	Device Number
3	DIN EN/IEC60747-5-5 Option (only appears on component ordered with this option)
4	One-Digit Year Code, e.g., “4”
5	Digit Work Week, Ranging from “01” to “53”
6	Assembly Package Code



NOTES:





- A) NO STANDARD APPLIES TO THIS PACKAGE
- B) ALL DIMENSIONS ARE IN MILLIMETERS.
- C) DIMENSIONS DO NOT INCLUDE MOLD FLASH OR BURRS.
- D) LANDPATTERN STANDARD: SOIC127P600X175-8M.
- E) DRAWING FILENAME: MKT-M08Erev5





TRADEMARKS

The following includes registered and unregistered trademarks and service marks, owned by Fairchild Semiconductor and/or its global subsidiaries, and is not intended to be an exhaustive list of all such trademarks.

- | | | | |
|---|--|---|---|
| AccuPower™ | F-PFS™ | OPTOPLANAR® |  |
| Awinda® | FRFET® |  | TinyBoost® |
| AX-CAP®* | Global Power Resource SM | PowerTrench® | TinyBuck® |
| BitSiC™ | GreenBridge™ | PowerXS™ | TinyCalc™ |
| Build it Now™ | Green FPS™ | Programmable Active Droop™ | TinyLogic® |
| CorePLUS™ | Green FPS™ e-Series™ | QFET® | TINYOPTO™ |
| CorePOWER™ | Gmax™ | QS™ | TinyPower™ |
| CROSSVOL™ | GTO™ | Quiet Series™ | TinyPWM™ |
| CTL™ | IntelliMAX™ | RapidConfigure™ | TinyWire™ |
| Current Transfer Logic™ | ISOPLANAR™ |  | TranSiC™ |
| DEUXPEED® | Making Small Speakers Sound Louder and Better™ | Saving our world, 1mW/W/kW at a time™ | TriFault Detect™ |
| Dual Cool™ | MegaBuck™ | SignalWise™ | TRUECURRENT®* |
| EcoSPARK® | MICROCOUPLER™ | SmartMax™ | μSerDes™ |
| EfficientMax™ | MicroFET™ | SMART START™ |  |
| ESBC™ | MicroPak™ | Solutions for Your Success™ | UHC® |
|  | MicroPak2™ | SPM® | Ultra FRFET™ |
| Fairchild® | MillerDrive™ | STEALTH™ | UniFET™ |
| Fairchild Semiconductor® | MotionMax™ | SuperFET® | VCX™ |
| FACT Quiet Series™ | MotionGrid® | SuperSOT™-3 | VisualMax™ |
| FACT® | MTI® | SuperSOT™-6 | VoltagePlus™ |
| FAST® | MTX® | SuperSOT™-8 | XS™ |
| FastvCore™ | MVN® | SupreMOS® | Xsens™ |
| FETBench™ | mWSaver® | SyncFET™ | 仙童™ |
| FPS™ | OptoHiT™ | Sync-Lock™ | |
| | OPTOLOGIC® | | |

* Trademarks of System General Corporation, used under license by Fairchild Semiconductor.

DISCLAIMER

FAIRCHILD SEMICONDUCTOR RESERVES THE RIGHT TO MAKE CHANGES WITHOUT FURTHER NOTICE TO ANY PRODUCTS HEREIN TO IMPROVE RELIABILITY, FUNCTION, OR DESIGN. TO OBTAIN THE LATEST, MOST UP-TO-DATE DATASHEET AND PRODUCT INFORMATION, VISIT OUR WEBSITE AT [HTTP://WWW.FAIRCHILDSEMI.COM](http://www.fairchildsemi.com). FAIRCHILD DOES NOT ASSUME ANY LIABILITY ARISING OUT OF THE APPLICATION OR USE OF ANY PRODUCT OR CIRCUIT DESCRIBED HEREIN; NEITHER DOES IT CONVEY ANY LICENSE UNDER ITS PATENT RIGHTS, NOR THE RIGHTS OF OTHERS. THESE SPECIFICATIONS DO NOT EXPAND THE TERMS OF FAIRCHILD'S WORLDWIDE TERMS AND CONDITIONS, SPECIFICALLY THE WARRANTY THEREIN, WHICH COVERS THESE PRODUCTS.

LIFE SUPPORT POLICY

FAIRCHILD'S PRODUCTS ARE NOT AUTHORIZED FOR USE AS CRITICAL COMPONENTS IN LIFE SUPPORT DEVICES OR SYSTEMS WITHOUT THE EXPRESS WRITTEN APPROVAL OF FAIRCHILD SEMICONDUCTOR CORPORATION.

As used herein:

1. Life support devices or systems are devices or systems which, (a) are intended for surgical implant into the body or (b) support or sustain life, and (c) whose failure to perform when properly used in accordance with instructions for use provided in the labeling, can be reasonably expected to result in a significant injury of the user.
2. A critical component in any component of a life support, device, or system whose failure to perform can be reasonably expected to cause the failure of the life support device or system, or to affect its safety or effectiveness.

ANTI-COUNTERFEITING POLICY

Fairchild Semiconductor Corporation's Anti-Counterfeiting Policy. Fairchild's Anti-Counterfeiting Policy is also stated on our external website, www.fairchildsemi.com, under Sales Support.

Counterfeiting of semiconductor parts is a growing problem in the industry. All manufacturers of semiconductor products are experiencing counterfeiting of their parts. Customers who inadvertently purchase counterfeit parts experience many problems such as loss of brand reputation, substandard performance, failed applications, and increased cost of production and manufacturing delays. Fairchild is taking strong measures to protect ourselves and our customers from the proliferation of counterfeit parts. Fairchild strongly encourages customers to purchase Fairchild parts either directly from Fairchild or from Authorized Fairchild Distributors who are listed by country on our web page cited above. Products customers buy either from Fairchild directly or from Authorized Fairchild Distributors are genuine parts, have full traceability, meet Fairchild's quality standards for handling and storage and provide access to Fairchild's full range of up-to-date technical and product information. Fairchild and our Authorized Distributors will stand behind all warranties and will appropriately address any warranty issues that may arise. Fairchild will not provide any warranty coverage or other assistance for parts bought from Unauthorized Sources. Fairchild is committed to combat this global problem and encourage our customers to do their part in stopping this practice by buying direct or from authorized distributors.

PRODUCT STATUS DEFINITIONS

Definition of Terms

Datasheet Identification	Product Status	Definition
Advance Information	Formative / In Design	Datasheet contains the design specifications for product development. Specifications may change in any manner without notice.
Preliminary	First Production	Datasheet contains preliminary data; supplementary data will be published at a later date. Fairchild Semiconductor reserves the right to make changes at any time without notice to improve design.
No Identification Needed	Full Production	Datasheet contains final specifications. Fairchild Semiconductor reserves the right to make changes at any time without notice to improve the design.
Obsolete	Not In Production	Datasheet contains specifications on a product that is discontinued by Fairchild Semiconductor. The datasheet is for reference information only.

Rev. I72