



Main

Range of product	Altivar 12
Product or component type	Variable speed drive
Product destination	Asynchronous motors
Product specific application	Simple machine
Assembly style	On base plate
Component name	ATV12
Quantity per set	Set of 1
EMC filter	Integrated
Built-in fan	Without
Network number of phases	Single phase
[Us] rated supply voltage	200...240 V (- 15...10 %)
Motor power kW	0.37 kW
Motor power hp	0.55 hp
Communication port protocol	Modbus
Line current	4.9 A at 240 V 5.9 A at 200 V
Speed range	1...20
Transient overtorque	150...170 % of nominal motor torque depending on drive rating and type of motor
Asynchronous motor control profile	Quadratic voltage/frequency ratio Sensorless flux vector control Voltage/Frequency ratio (V/f)
IP degree of protection	IP20 without blanking plate on upper part
Noise level	0 dB

Complementary

Supply frequency	50/60 Hz (+/- 5 %)
Type of connector	1 RJ45 for Modbus on front face
Physical interface	2-wire RS 485 for Modbus
Transmission frame	RTU for Modbus
Transmission rate	38400 bit/s 19200 bit/s 9600 bit/s 4800 bit/s
Number of addresses	1...247 for Modbus
Communication service	Read device identification (43) Read/Write multiple registers (23), messaging: 4/4 words maximum Write multiple registers (16), messaging: 27 words maximum Write single register (06), messaging: 29 words maximum Read holding registers (03), messaging: 29 words maximum
Prospective line I _{sc}	<= 1 kA
Continuous output current	2.4 A at 4 kHz
Maximum transient current	3.6 A for 60 s
Speed drive output frequency	0.5...400 Hz
Nominal switching frequency	4 kHz

Switching frequency	4...16 kHz with derating factor 2...16 kHz adjustable
Braking torque	Upto 70 % of nominal motor torque without braking resistor Upto 150 % of nominal motor torque with braking resistor at high inertia
Motor slip compensation	Adjustable Preset in factory
Electrical connection	L1, L2, L3, U, V, W, PA, PC terminal 3.5 mm ² (AWG 12)
Tightening torque	0.8 N.m
Insulation	Electrical between power and control
Supply	Internal supply for logic inputs 24 V DC, voltage limits 20.4...28.8 V 100 mA for overload and short-circuit protection Internal supply for reference potentiometer 5 V DC, voltage limits 4.75...5.25 V 10 mA for overload and short-circuit protection
Analogue input number	1
Analogue input type	AI1 configurable voltage 0...5 V, impedance 30 kOhm AI1 configurable voltage 0...10 V, impedance 30 kOhm AI1 configurable current 0...20 mA, impedance 250 Ohm
Discrete input number	4
Discrete input type	(LI1...LI4) programmable, 24 V, voltage limits 18...30 V
Discrete input logic	Positive logic (source), 0... < 5 V (state 0), > 11 V (state 1) Negative logic (sink), > 16 V (state 0), < 10 V (state 1), input impedance 3.5 kOhm
Sampling duration	< 20 ms, tolerance +/- 1 ms for logic input < 10 ms for analogue input
Linearity error	+/- 0.3 % of maximum value for analogue input
Analogue output number	1
Analogue output type	(AO1) software-configurable current, analogue output range 0...20 mA, output impedance 800 Ohm, analogue output resolution 8 bits (AO1) software-configurable voltage, analogue output range 0...10 V, output impedance 470 Ohm, analogue output resolution 8 bits
Discrete output number	2
Discrete output type	(R1A, R1B, R1C) protected relay output 1 C/O (LO+, LO-) logic output
Minimum switching current	5 mA at 24 V DC for logic relay
Maximum switching current	4 A at 30 V DC resistive load cos phi = 1 L/R = 0 ms for logic relay 3 A at 250 V AC resistive load cos phi = 1 L/R = 0 ms for logic relay 2 A at 30 V DC inductive load cos phi = 0.4 L/R = 7 ms for logic relay 2 A at 250 V AC inductive load cos phi = 0.4 L/R = 7 ms for logic relay
Acceleration and deceleration ramps	Linear from 0 to 999.9 s S U
Braking to standstill	By DC injection, 0.1...30 s
Protection type	Thermal motor protection via the drive by continuous calculation of I ² t Against input phase loss in three-phase Short-circuit between motor phases Overheating protection Overcurrent between output phases and earth Line supply undervoltage Line supply overvoltage
Frequency resolution	Display unit 0.1 Hz Analog input converter A/D, 10 bits
Time constant	20 ms, tolerance +/- 1 ms for reference change
Marking	CE
Operating position	Vertical +/- 10 degree
Height	143 mm
Width	72 mm
Depth	102.2 mm
Product weight	0.7 kg

Environment

Electromagnetic compatibility	Surge immunity test (level 3) conforming to EN/IEC 61000-4-5 Voltage dips and interruptions immunity test conforming to EN/IEC 61000-4-11 Radiated radio-frequency electromagnetic field immunity test (level 3) conforming to EN/IEC 61000-4-3 Immunity to conducted disturbances (level 3) conforming to EN/IEC 61000-4-6 Electrostatic discharge immunity test (level 3) conforming to EN/IEC 61000-4-2 Electrical fast transient/burst immunity test (level 4) conforming to EN/IEC 61000-4-4
Electromagnetic emission	Conducted emissions with additional EMC filter, class: environment 2 category C3 conforming to EN/IEC 61800-3 - test level: 4...12 kHz, <= 50 m shielded motor cable Conducted emissions with additional EMC filter, class: environment 1 category C2 conforming to EN/IEC 61800-3 - test level: 4...12 kHz, <= 50 m shielded motor cable Conducted emissions with additional EMC filter, class: environment 1 category C1 conforming to EN/IEC 61800-3 - test level: 4...12 kHz, <= 20 m shielded motor cable Conducted emissions with integrated EMC filter, class: environment 1 category C2 conforming to EN/IEC 61800-3 - test level: 2, 4 and 16 kHz, <= 10 m shielded motor cable Conducted emissions with integrated EMC filter, class: environment 1 category C2 conforming to EN/IEC 61800-3 - test level: 2...12 kHz, <= 5 m shielded motor cable Conducted emissions with integrated EMC filter, class: environment 1 category C1 conforming to EN/IEC 61800-3 - test level: 2, 4, 8, 12 and 16 kHz, <= 5 m shielded motor cable Radiated emissions, class: environment 1 category C2 conforming to EN/IEC 61800-3 - test level: 2...16 kHz shielded motor cable
Product certifications	CSA C-Tick GOST NOM UL
Vibration resistance	1.5 mm peak to peak (f = 3...13 Hz) drive unmounted on symmetrical DIN rail conforming to EN/IEC 60068-2-6 1 gn (f = 13...200 Hz) conforming to EN/IEC 60068-2-6
Shock resistance	15 gn for 11 ms conforming to EN/IEC 60068-2-27
Relative humidity	5...95 % without dripping water conforming to IEC 60068-2-3 5...95 % without condensation conforming to IEC 60068-2-3
Ambient air temperature for storage	-25...70 °C
Ambient air temperature for operation	40...60 °C with current derating 2.2 % per °C -10...40 °C with protective cover from the top of the drive removed
Operating altitude	<= 1000 m without derating > 1000...2000 m with current derating 1 % per 100 m

Offer Sustainability

Sustainable offer status	Green Premium product
RoHS	Compliant - since 0901 - Schneider Electric declaration of conformity
REACH	Reference contains SVHC above the threshold - go to CaP for more details
Product environmental profile	Available Download Product Environmental
Product end of life instructions	Need no specific recycling operations

Contractual warranty

Period	18 months
--------	-----------

Dimensions

Drive without EMC Conformity Kit

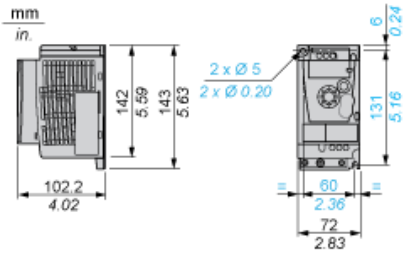

Drive with EMC Conformity Kit

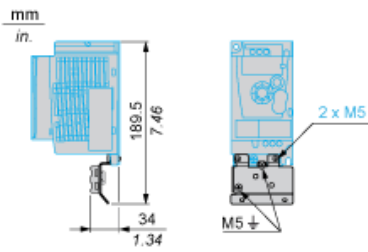

Mounting Recommendations

Clearance for Vertical Mounting

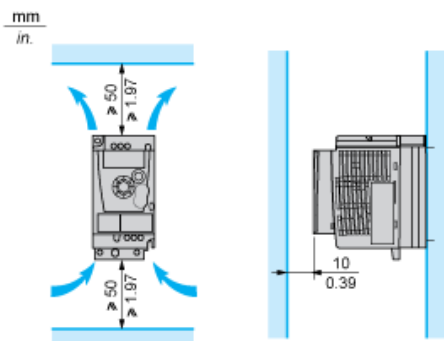

Mounting Type A

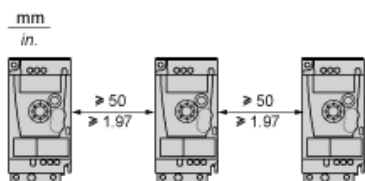

Mounting Type B

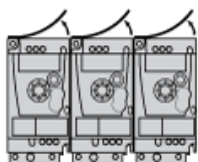

Remove the protective cover from the top of the drive.

Mounting Type C

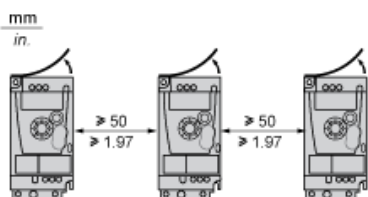

Remove the protective cover from the top of the drive.

Single-Phase Power Supply Wiring Diagram

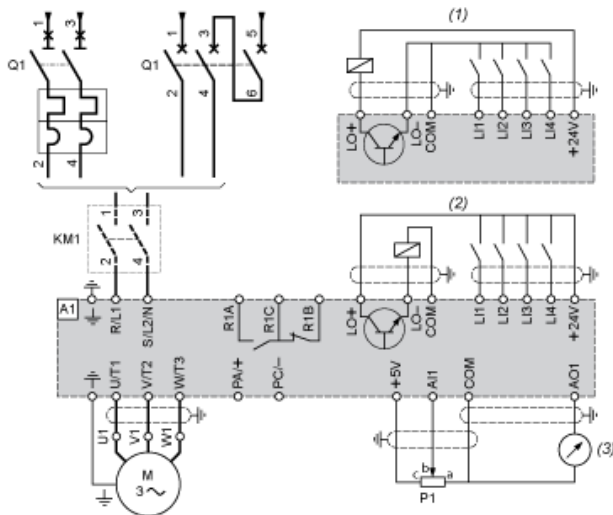

- A1 Drive
- KM1 Contactor (only if a control circuit is needed)
- P1 2.2 kΩ reference potentiometer. This can be replaced by a 10 kΩ potentiometer (maximum).
- Q1 Circuit breaker
- (1) Negative logic (Sink)
- (2) Positive logic (Source) (factory set configuration)
- (3) 0...10 V or 0...20 mA

Recommended Schemes

2-Wire Control for Logic I/O with Internal Power Supply

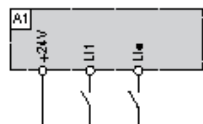

- L1 : Forward
- L1• : Reverse
- A1 : Drive

3-Wire Control for Logic I/O with Internal Power Supply

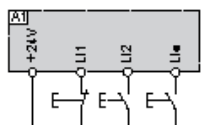

- L1 : Stop
- L2 : Forward
- L1• : Reverse
- A1 : Drive

Analog Input Configured for Voltage with Internal Power Supply

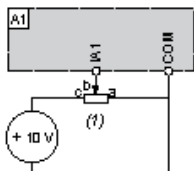

- (1) 2.2 kΩ...10 kΩ reference potentiometer
- A1 : Drive

Analog Input Configured for Current with Internal Power Supply

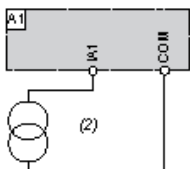

- (2) 0-20 mA 4-20 mA supply
- A1 : Drive

Connected as Positive Logic (Source) with External 24 vdc Supply

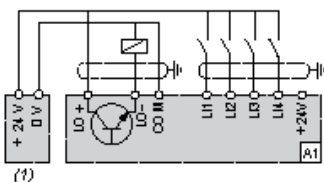

- (1) 24 vdc supply
- A1 : Drive

Connected as Negative Logic (Sink) with External 24 vdc supply

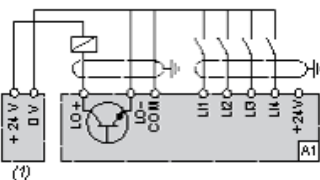

- (1) 24 vdc supply
- A1 : Drive

Torque Curves

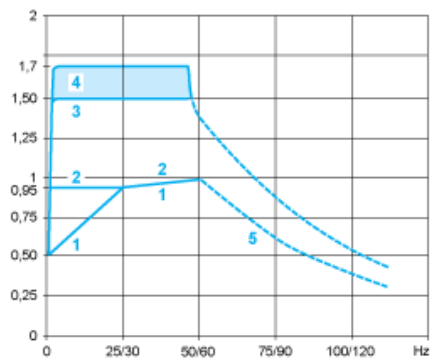

- 1 : Self-cooled motor: continuous useful torque (1)
 - 2 : Force-cooled motor: continuous useful torque
 - 3 : Transient overtorque for 60 s
 - 4 : Transient overtorque for 2 s
 - 5 : Torque in overspeed at constant power (2)
- (1) For power ratings ≤ 250 W, derating is 20% instead of 50% at very low frequencies.
(2) The nominal motor frequency and the maximum output frequency can be adjusted from 0.5 to 400 Hz. The mechanical overspeed capability of the selected motor must be checked with the manufacturer.