



Alu HEX Par 64 **(12 x 12W 6in1 colour LEDs RGBWAUV)**

User Manual



Order code: ELUM114

WARNING

FOR YOUR OWN SAFETY, PLEASE READ THIS USER MANUAL CAREFULLY BEFORE YOUR INITIAL START-UP!

- Before your initial start-up, please make sure that there is no damage caused during transportation.
- Should there be any damage, consult your dealer and do not use the equipment.
- To maintain the equipment in good working condition and to ensure safe operation, it is necessary for the user to follow the safety instructions and warning notes written in this manual.
- Please note that damages caused by user modifications to this equipment are not subject to warranty.



IMPORTANT:

The manufacturer will not accept liability for any resulting damages caused by the non-observance of this manual or any unauthorised modification to the equipment.

- Never let the power cable come into contact with other cables. Handle the power cable and all mains voltage connections with particular caution!
- Never remove warning or informative labels from the unit.
- Do not open the equipment and do not modify the unit.
- Do not connect this equipment to a dimmer pack.
- Do not switch the equipment on and off in short intervals, as this will reduce the system's life.
- Only use the equipment indoors.
- Do not expose to flammable sources, liquids or gases.
- Always disconnect the power from the mains when equipment is not in use or before cleaning! Only handle the power-cable by the plug. Never pull out the plug by pulling the power-cable.
- Make sure that the available voltage is between 100~240V, 50/60Hz.
- Make sure that the power cable is never crimped or damaged. Check the equipment and the power cable periodically.
- If the equipment is dropped or damaged, disconnect the mains power supply immediately and have a qualified engineer inspect the equipment before operating again.
- If the equipment has been exposed to drastic temperature fluctuation (e.g. after transportation), do not connect power or switch it on immediately. The arising condensation might damage the equipment. Leave the equipment switched off until it has reached room temperature.
- If your product fails to function correctly, stop use immediately. Pack the unit securely (preferably in the original packing material), and return it to your Pro Light dealer for service.
- Only use fuses of same type and rating.
- Repairs, servicing and power connection must only be carried out by a qualified technician. THIS UNIT CONTAINS NO USER SERVICEABLE PARTS.
- WARRANTY: One year from date of purchase.

OPERATING DETERMINATIONS

If this equipment is operated in any other way, than those described in this manual, the product may suffer damage and the warranty becomes void. Incorrect operation may lead to danger e.g: short-circuit, burns and electric shocks etc.

Do not endanger your own safety and the safety of others!

Incorrect installation or use can cause serious damage to people and/or property.

Alu HEX Par 64

Housing 12 x 12W hex-colour LEDs, the Alu HEX Par 64 gives smooth colour mixing from rich saturated hues to subtle pastel shades. These units have rugged housing and feature a 25° beam angle. The 4 push button LED menu allows for easy access to the functions including DMX, master/slave, sound active and stand alone.

- 2 year warranty
- 12 x 12W 6in1 colour LEDs (RGBWAUV)
- Beam angle: 25°
- 3.6kHz refresh rate
- DMX channels: 1/3/4/5/6/7/8 or 9 selectable
- Static colour, colour change, colour fade, auto, sound active and master/slave modes
- 0-100% dimming and variable strobe
- 4 push button menu with LED display
- 3-pin XLR in/out sockets
- PowerCON in/out sockets
- Fan cooled
- Optional Barn Doors (ELUM041C)

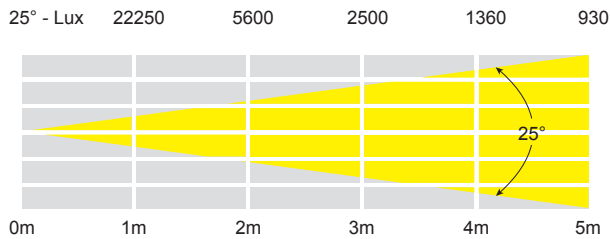

Specifications	Alu HEX Par 64
Power consumption	150W
Power supply	100~240V, 50/60Hz
Dimensions	300 x 280 x 240mm
Weight	5.3kg
Order code	ELUM114

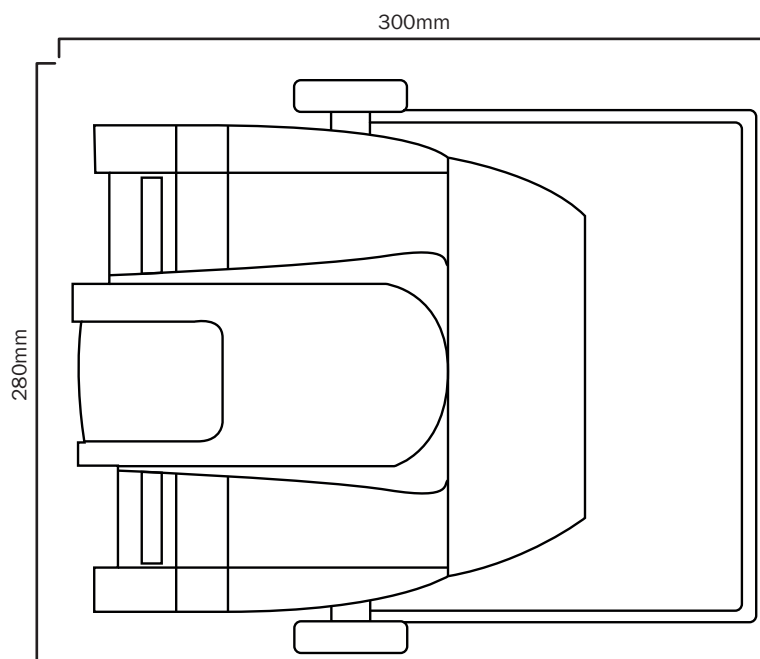

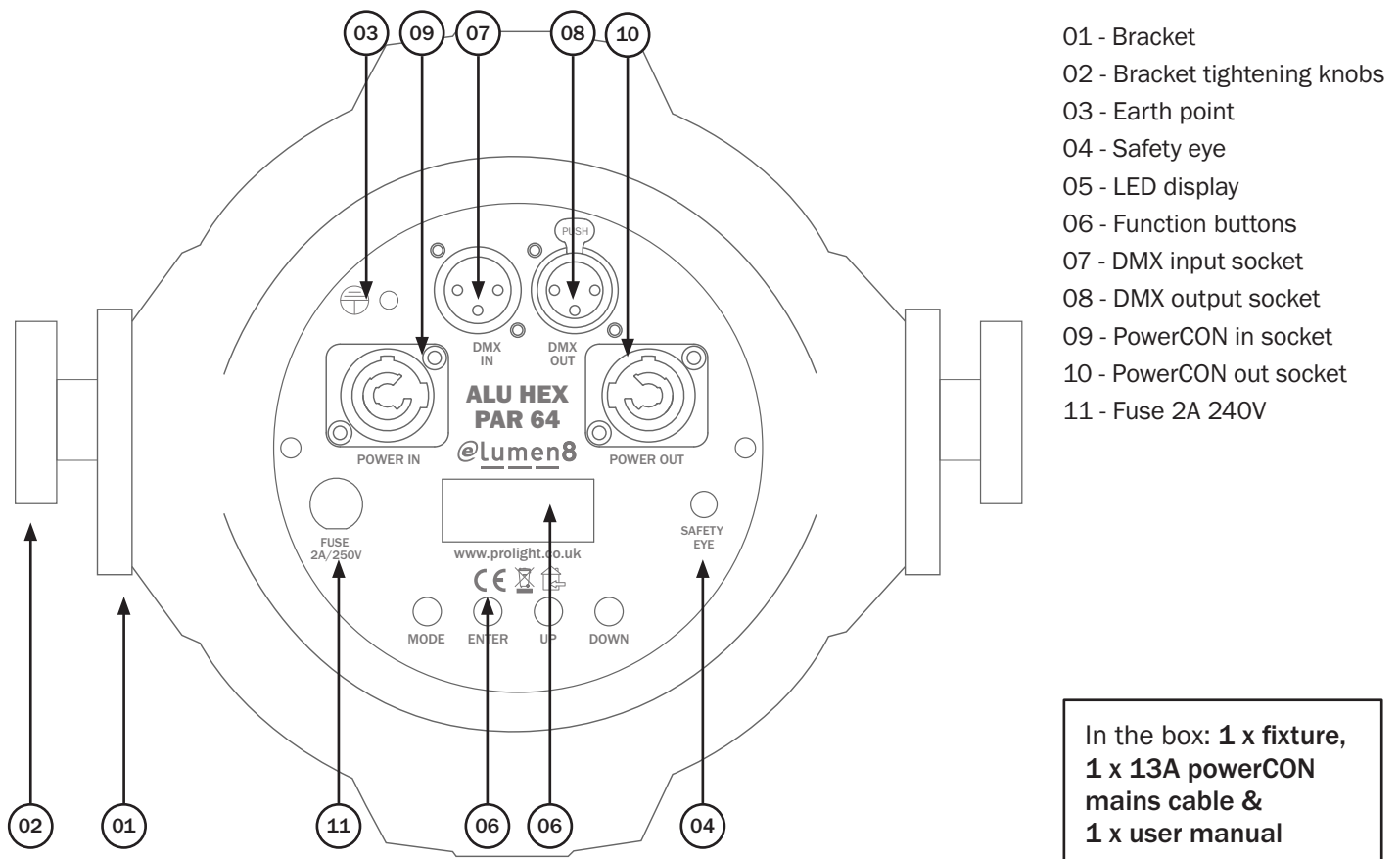

Operating instructions

DMX channel mode:

Operating in DMX control mode gives the user the greatest flexibility when it comes to customising or creating a show. In this mode you will be able to control each individual trait of the fixture and each fixture independently.

To access the DMX channel mode, press the **“MODE”** button on the rear of the unit to show **“CH:01”** on the LED display, then use the **“UP”** and **“DOWN”** buttons to set the desired DMX address of either 1, 3, 4, 5, 6, 7 or 9 DMX channel modes.

To set the units address, press the **“MODE”** button on the rear of the unit to show **“ADDR:001”** on the LED display, then use the **“UP”** and **“DOWN”** buttons to set the desired address from **“001”** - **“512”**.

Press the **“ENTER”** button to confirm any settings.

To exit out of any of the above options, press the **“MODE”** button.

2 channel mode:

Channel	Value	Function
1	000-255	Master dimmer (0-100%)
2 000-255 colour macro	000-016	Red
	017-033	Green
	034-050	Blue
	051-067	White
	068-084	Amber
	085-101	UV
	102-118	Yellow (R - 255, G - 200, A - 255)
	119-135	Cyan (G - 255, B - 255)
	136-152	Lavender (R - 170, B - 210)
	153-169	Bright green (G - 255, A - 180)
	170-186	Magenta (R - 255, B - 90, UV - 255)
	187-203	Turquoise (G - 255, B - 180, UV - 255)
	204-220	Orange (R - 200, A - 200)
	221-237	Cool white (R - 70, G - 190, B - 255, A - 200)
	238-255	Warm white (R - 230, G - 255, B - 255, A - 255, W - 255)

3 channel mode:

Channel	Value	Function
1	000-255	Master dimmer (0-100%)
2	000-255	Flash (speed 0-100%, 1Hz-20Hz)
3	000-004	Blackout
	005-010	Red
	011-015	Green
	016-020	Blue
	021-025	White
	026-030	Amber
	031-035	UV
	036-040	Yellow (R - 255, G - 200, A - 255)
	041-045	Cyan (G - 255, B - 255)
	046-050	Lavender (R - 170, B - 210)
	051-055	Bright green (G - 255, A - 180)
	056-060	Magenta (R - 255, B - 90, UV - 255)
	061-065	Turquoise (G - 255, B - 180, UV - 255)
	066-070	Orange (R - 200, A - 200)
	071-075	Cool white (R - 70, G - 190, B - 255, A - 200)
	076-080	Warm white (R - 230, G - 255, B - 255, A - 255, W - 255)
	081-150	Colour jumping speed. Slowest (081) changes every 8 secs, Fastest (150) changes every 0.3 secs
	151-220	Colour fading speed. Slowest (151) changes every 8 secs, Fastest (220) changes every 0.3 secs
221-255	Sound control (mic sensitivity)	

3 channel mode:

Channel	Value	Function
1	000-255	Red (0-100%)
2	000-255	Green (0-100%)
3	000-255	Blue (0-100%)

4 channel mode:

Channel	Value	Function
1	000-255	Red (0-100%)
2	000-255	Green (0-100%)
3	000-255	Blue (0-100%)
4	000-255	White (0-100%)

4 channel mode:

Channel	Value	Function
1	000-255	Red (0-100%)
2	000-255	Green (0-100%)
3	000-255	Blue (0-100%)
4	000-255	Amber (0-100%)

5 channel mode:

Channel	Value	Function
1	000-255	Red (0-100%)
2	000-255	Green (0-100%)
3	000-255	Blue (0-100%)
4	000-255	White (0-100%)
5	000-255	Amber (0-100%)

6 channel mode:

Channel	Value	Function
1	000-255	Red (0-100%)
2	000-255	Green (0-100%)
3	000-255	Blue (0-100%)
4	000-255	White (0-100%)
5	000-255	Amber (0-100%)
6	000-255	UV (0-100%)

9 channel mode:

Channel	Value	Function
1	000-255	Master dimmer (0-100%)
2	000-255	Flash (speed 0-100%, 1Hz-20Hz)
3	000-255	Red (0-100%)
4	000-255	Green (0-100%)
5	000-255	Blue (0-100%)
6	000-255	White (0-100%)
7	000-255	Amber (0-100%)
8	000-255	UV (0-100%)
9	000-004	Blackout
	005-010	Red
	011-015	Green
	016-020	Blue
	021-025	White
	026-030	Amber
	031-035	UV
	036-040	Yellow (R - 255, G - 200, A - 255)
	041-045	Cyan (G - 255, B - 255)
	046-050	Lavender (R - 170, B - 210)
	051-055	Bright green (G - 255, A - 180)
	056-060	Magenta (R - 255, B - 90, UV - 255)
	061-065	Turquoise (G - 255, B - 180, UV - 255)
	066-070	Orange (R - 200, A - 200)
	071-075	Cool white (R - 70, G - 190, B - 255, A - 200)
	076-080	Warm white (R - 230, G - 255, B - 255, A - 255, W - 255)
081-150	Colour jumping speed Slowest (081) changes every 8 secs Fastest (150) changes every 0.3 secs	
151-220	Colour fading speed Slowest (151) changes every 8 secs Fastest (220) changes every 0.3 secs	
221-255	Sound control (mic sensitivity)	

Master/slave mode

To set the master unit, press the “**MODE**” button on the rear of the master unit then select your desired program. To set in slave mode, press the “**MODE**” button on the rear of the unit and set the address to show “**SLAVE MODE**” on the LED display. The unit will now run in sequence with the master unit.

Sound active mode:

To access the sound active mode, press the “**MODE**” button on the rear of the unit to show “**SOUND**” on the LED display. The unit will now be in sound active mode. Press “**ENTER**” the display will flash, now use the “**UP**” and “**DOWN**” buttons to set the sound sensitivity level from “**SENS:00**” - “**SENS:31**” (00 = low, 31 = high).

Press the “**ENTER**” button to confirm any settings.

To exit out of any of the above options, press the “**MODE**” button.

Static colour mix mode:

To access the static colour mode, press the “**MODE**” button to show “**1.STATIC**” on the rear of the unit. You can then use the enter button to select and set the desired colours and brightness for R, G, B, W, A and UV from “**00**” - “**99**”. You can then set the strobe speed from “**F00**” - “**F99**”.

Press the “**ENTER**” button to confirm any settings.

To exit out of any of the above options, press the “**MODE**” button.

Built-in programs mode

To access the built-in programs mode, press the “**MODE**” button on the rear of the unit to show one of the following on the display:

“**2.CHANGE**” will show on the LED display for the 30 colours change mode.

“**2.CHANG6**” will show on the LED display for the 6 colours change mode.

“**04.DREAM**” will show on the LED display for the colour fade mode.

On the above 3 options you can then set the desired colour change speed from “**SP01**” - “**SP99**” and the strobe speed from “**F00**” - “**F99**”.

Press the “**ENTER**” button to confirm any settings.

To exit out of any of the above options, press the “**MODE**” button.

Setting the DMX address:

The DMX mode enables the use of a universal DMX controller. Each fixture requires a “start address” from 1- 511. A fixture requiring one or more channels for control begins to read the data on the channel indicated by the start address. For example, a fixture that occupies or uses 7 channels of DMX and was addressed to start on DMX channel 100, would read data from channels: 100,101,102,103,104,105 and 106. Choose a start address so that the channels used do not overlap. E.g. the next unit in the chain starts at 107.

DMX 512:

DMX (Digital Multiplex) is a universal protocol used as a form of communication between intelligent fixtures and controllers. A DMX controller sends DMX data instructions from the controller to the fixture. DMX data is sent as serial data that travels from fixture to fixture via the DATA “IN” and DATA “OUT” XLR terminals located on all DMX fixtures (most controllers only have a data “out” terminal).

DMX linking:

DMX is a language allowing all makes and models of different manufactures to be linked together and operate from a single controller, as long as all fixtures and the controller are DMX compliant. To ensure proper DMX data transmission, when using several DMX fixtures try to use the shortest cable path possible. The order in which fixtures are connected in a DMX line does not influence the DMX addressing. For example; a fixture assigned to a DMX address of 1 may be placed anywhere in a DMX line, at the beginning, at the end, or anywhere in the middle. When a fixture is assigned a DMX address of 1, the DMX controller knows to send DATA assigned to address 1 to that unit, no matter where it is located in the DMX chain.

DATA cable (DMX cable) requirements (for DMX operation):

This fixture can be controlled via DMX-512 protocol. The DMX address is set on the back of the unit. Your unit and your DMX controller require a standard 3-pin XLR connector for data input/output, see image below.



Further DMX cables can be purchased from all good sound and lighting suppliers or Pro Light Concepts dealers.

Please quote:

CABL10 – 2m

CABL11 – 5m

CABL12 – 10m

Note: DMX cable must be daisy chained and cannot be split.

Notice:

Be sure to follow the diagrams below when making your own cables. Do not connect the cables shield conductor to the ground lug or allow the shield conductor to come in contact with the XLRs outer casing. Grounding the shield could cause a short circuit and erratic behaviour.

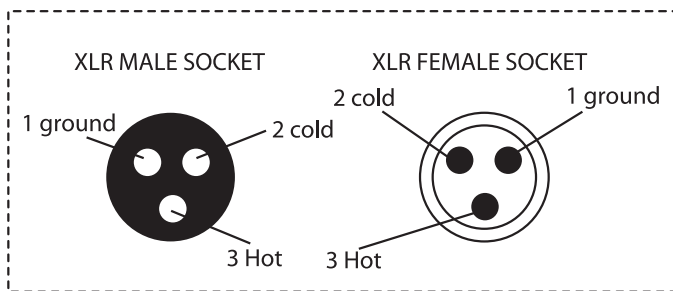
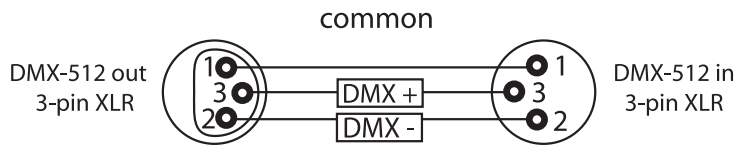

XLR Pin Configuration
Pin 1 = Ground
Pin 2 = Negative
Pin 3 = Postive

Special note:

Line termination:

When longer runs of cable are used, you may need to use a terminator on the last unit to avoid erratic behaviour.

Using a cable terminator will decrease the possibilities of erratic behaviour.

(3-pin - Order ref: CABL90, 5-pin - Order ref: CABL89)

Termination reduces signal transmission problems and interference. It is always advisable to connect a DMX terminal, (resistance 120 Ohm 1/4 W) between pin 2 (DMX-) and pin 3 (DMX+) of the last fixture.

5-pin XLR DMX connectors:

Some manufactures use 5-pin XLR connectors for data transmission in place of 3-pin. 5-pin XLR fixtures may be implemented in a 3-pin XLR DMX line. When inserting standard 5-pin XLR connectors in to a 3-pin line a cable adaptor must be used. The diagram below details the correct cable conversion.

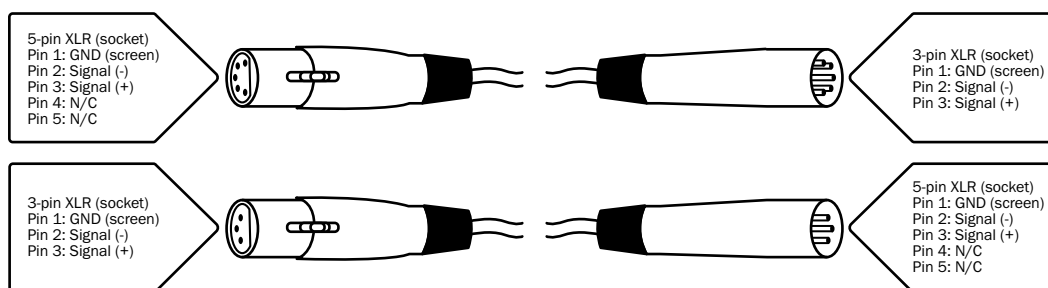

Please contact your local retailer to purchase these accessories.

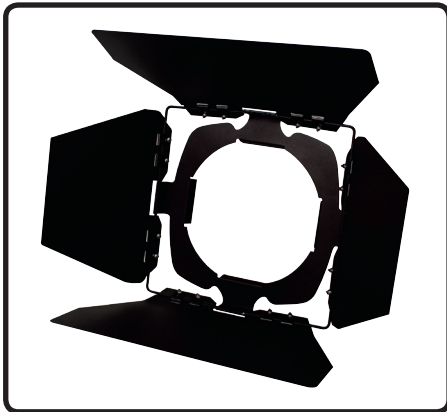

Optional eLumen8 Alu Tri Barn Door
Order code: ELUM041C



Optional LEDJ Alu Par 64 Series
Floor Bracket
Order Code - LEDJ119



Optional Cases
Order codes: Twin - CASE17
Twin - CASE16

To keep up-to-date on the latest accessories and product range additions please visit www.prolight.co.uk



***Correct Disposal of this Product
(Waste Electrical & Electronic Equipment)***

**(Applicable in the European Union and other European countries
with separate collection systems)**

This marking shown on the product or its literature, indicates that it should not be disposed with other household wastes at the end of its working life. To prevent possible harm to the environment or human health from uncontrolled waste disposal, please separate this from other types of wastes and recycle it responsibly to promote the sustainable reuse of material resources.

Household users should contact either the retailer where they purchased this product, or their local government office, for details of where and how they can take this item for environmentally safe recycling.

Business users should contact their supplier and check the terms and conditions of the purchase contract. This product should not be mixed with other commercial wastes for disposal.



