

# Analog Devices Welcomes Hittite Microwave Corporation

NO CONTENT ON THE ATTACHED DOCUMENT HAS CHANGED



**THIS PAGE INTENTIONALLY LEFT BLANK**

## GaAs PHEMT MEDIUM POWER AMPLIFIER, 17 - 24 GHz

### Typical Applications

The HMC498LC4 is ideal for use as a LNA or Driver amplifier for:

- Point-to-Point Radios
- Point-to-Multi-Point Radios & VSAT
- Test Equipment & Sensors
- Military End-Use

### Features

- Output IP3: +36 dBm
- Saturated Power: +26 dBm @ 23% PAE
- Gain: 22 dB
- +5V @ 250 mA Supply
- 50 Ohm Matched Input/Output
- RoHS Compliant 4x4 mm SMT Package

### Functional Diagram

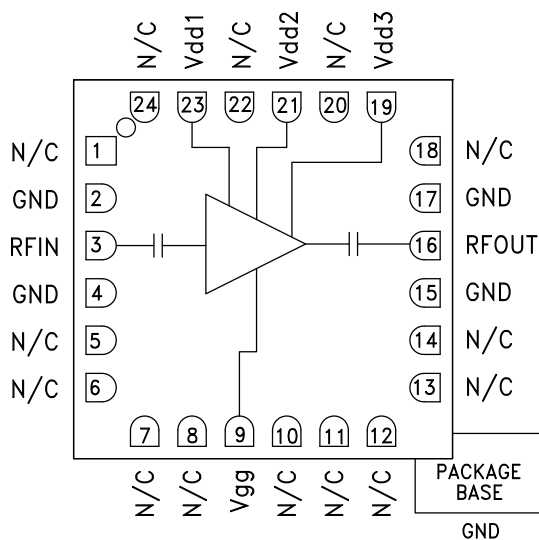

### General Description

The HMC498LC4 is a high dynamic range GaAs PHEMT MMIC Medium Power Amplifier housed in a leadless "Pb free" SMT package. Operating from 17 to 24 GHz, the amplifier provides 22 dB of gain, +26 dBm of saturated power and 23% PAE from a +5V supply voltage. Noise figure is 4 dB while output IP3 is +36 dBm typical enabling the HMC498LC4 to function as a low noise front end as well as a driver amplifier. The RF I/Os are DC blocked and matched to 50 Ohms for ease of use. The HMC498LC4 eliminates the need for wire bonding, allowing use of surface mount manufacturing techniques.

### Electrical Specifications, $T_A = +25^\circ \text{C}$ , $V_{dd1, 2, 3} = 5\text{V}$ , $I_{dd} = 250 \text{mA}^*$

Parameter	Min.	Typ.	Max.	Min.	Typ.	Max.	Min.	Typ.	Max.	Units
Frequency Range	17 - 19			19 - 23			23 - 24			GHz
Gain	18	22		20	22.5		18	21		dB
Gain Variation Over Temperature		0.02	0.03		0.02	0.03		0.02	0.03	dB/°C
Input Return Loss		13			13			10		dB
Output Return Loss		15			15			20		dB
Output Power for 1 dB Compression (P1dB)	22	25		21.5	24.5		22.5	25.5		dBm
Saturated Output Power (Psat)		26.5			25.5			26.5		dBm
Output Third Order Intercept (IP3)		35			36			35.5		dBm
Noise Figure		4.0			4.0			4.5		dB
Supply Current (I <sub>dd</sub> )(V <sub>dd</sub> = +5V, V <sub>gg</sub> = -0.8V Typ.)		250			250			250		mA

\* Adjust V<sub>gg</sub> between -2 to 0V to achieve I<sub>dd</sub> = 250 mA typical.

## GaAs PHEMT MEDIUM POWER AMPLIFIER, 17 - 24 GHz

**Broadband Gain & Return Loss**

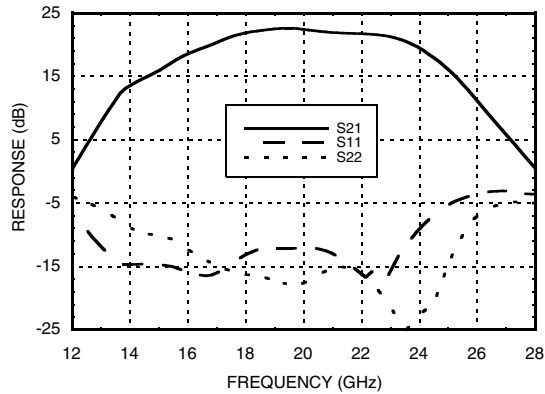

**Gain vs. Temperature**

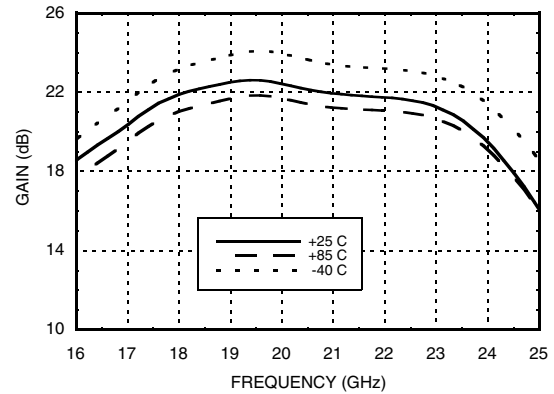

**Input Return Loss vs. Temperature**

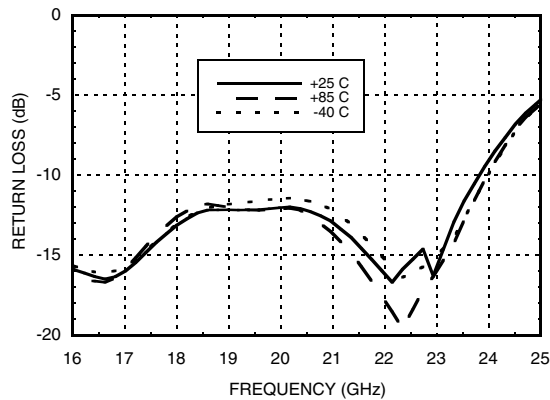

**Output Return Loss vs. Temperature**

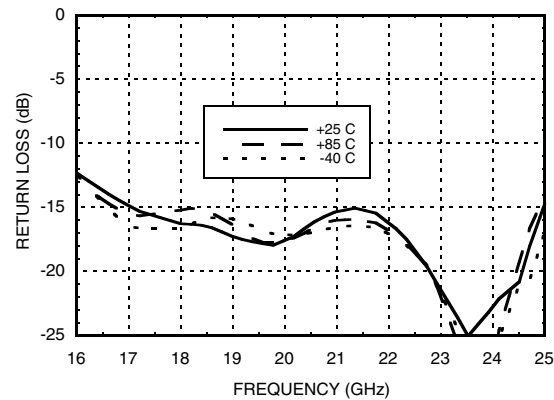

**P1dB vs. Temperature**

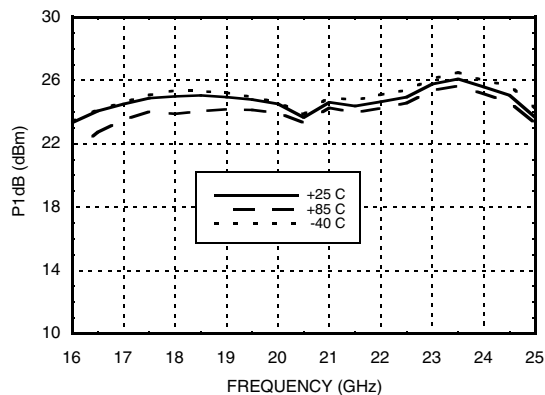

**Psat vs. Temperature**

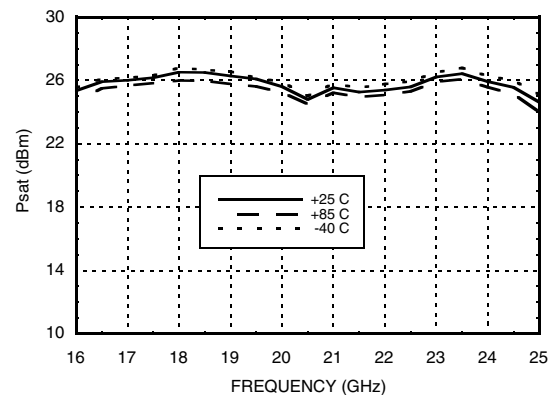

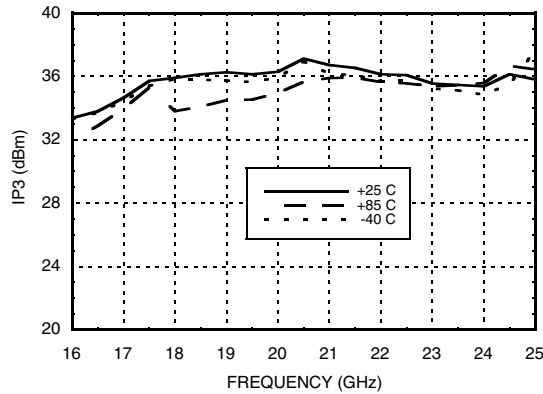
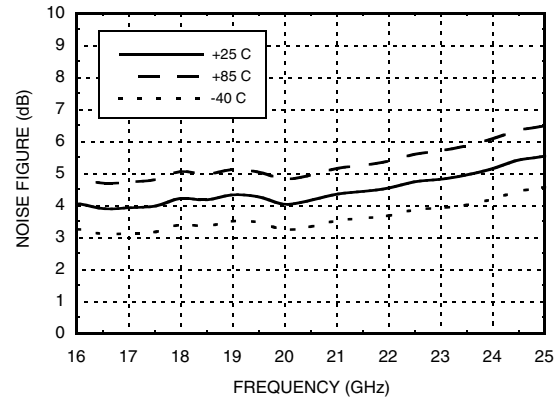
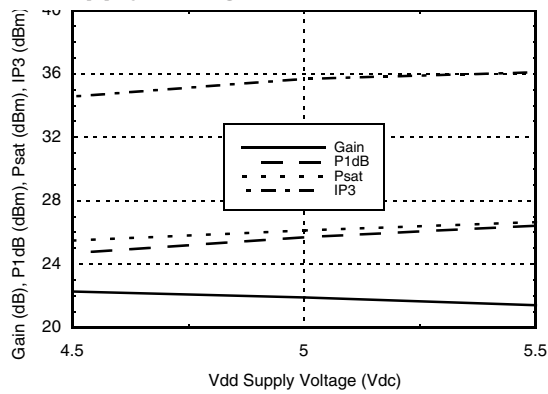
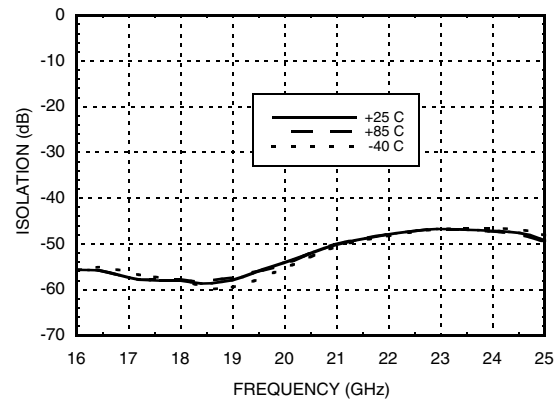
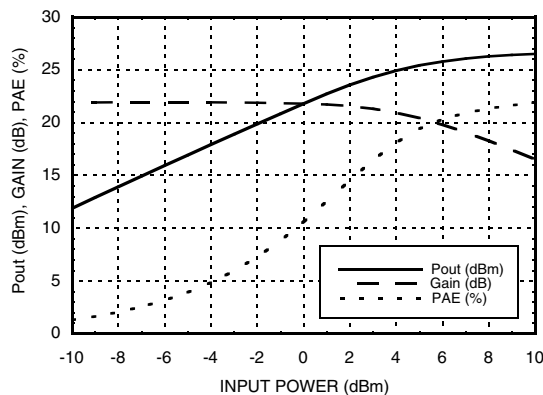
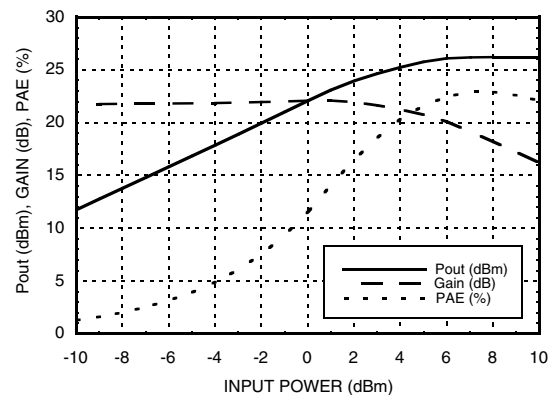
**GaAs PHEMT MEDIUM  
POWER AMPLIFIER, 17 - 24 GHz**
**Output IP3 vs. Temperature**

**Noise Figure vs. Temperature**

**Gain, Power & OIP3  
vs. Supply Voltage @ 23 GHz**

**Reverse Isolation vs. Temperature**

**Power Compression @ 18 GHz**

**Power Compression @ 23 GHz**

**GaAs PHEMT MEDIUM  
POWER AMPLIFIER, 17 - 24 GHz**
**Absolute Maximum Ratings**

Drain Bias Voltage (Vdd1, Vdd2, Vdd3)	+5.5 Vdc
Gate Bias Voltage (Vgg)	-4.0 to 0 Vdc
RF Input Power (RFIN)(Vdd = +5Vdc)	+10 dBm
Channel Temperature	175 °C
Continuous Pdiss (T= 85 °C) (derate 18 mW/°C above 85 °C)	1.62 W
Thermal Resistance (channel to ground paddle)	55.6 °C/W
Storage Temperature	-65 to +150 °C
Operating Temperature	-40 to +85 °C
ESD Sensitivity (HBM)	Class 1A

**Typical Supply Current vs. Vdd**

Vdd (Vdc)	Idd (mA)
+4.5	239
+5.0	250
+5.5	262

Note: Amplifier will operate over full voltage ranges shown above. Vgg adjusted to achieve Idd= 250 mA at +5V.

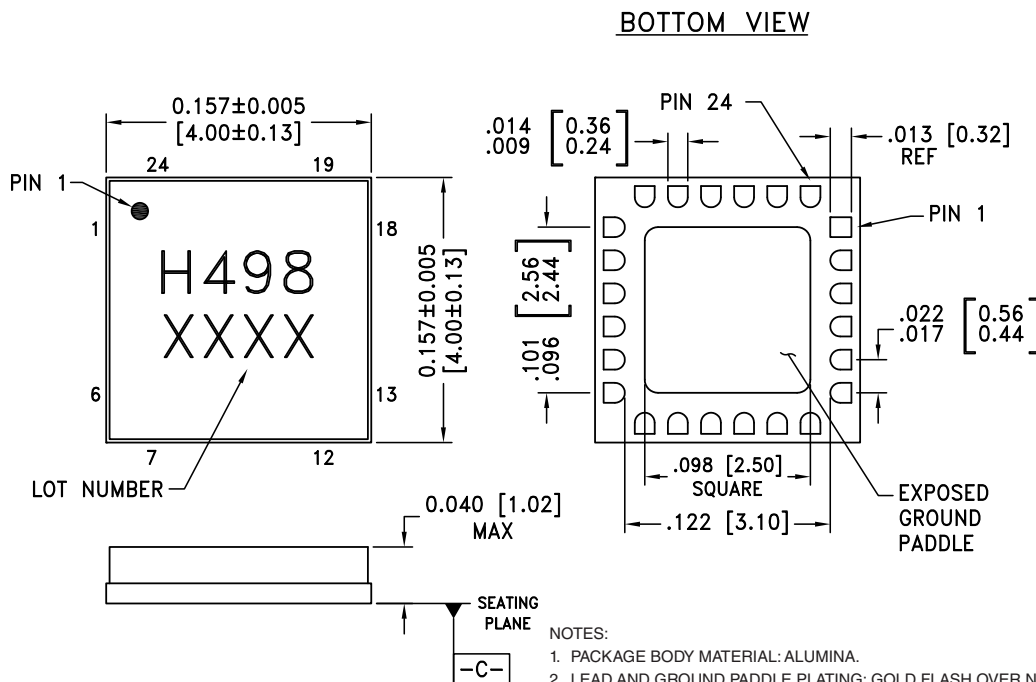

**ELECTROSTATIC SENSITIVE DEVICE  
OBSERVE HANDLING PRECAUTIONS**

**Outline Drawing**

**Package Information**

Part Number	Package Body Material	Lead Finish	MSL Rating	Package Marking [2]
HMC498LC4	Alumina, White	Gold over Nickel	MSL3 [1]	H498 XXXX

[1] Max peak reflow temperature of 260 °C

[2] 4-Digit lot number XXXX

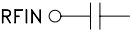
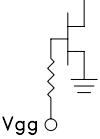
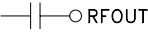
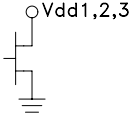
**Pin Descriptions**

Pin Number	Function	Description	Interface Schematic
1, 5 - 8, 10 - 14, 18, 20, 22, 24	N/C	These pins are not connected internally; however, all data shown herein was measured with these pins connected to RF/DC ground externally.	
2, 4, 15, 17	GND	Package bottom has an exposed metal paddle that must also be connected to RF/DC ground.	
3	RFIN	This pin is AC coupled and matched to 50 Ohms.	
9	Vgg	Gate control for amplifier. Adjust to achieve Id of 250 mA. Please follow "MMIC Amplifier Biasing Procedure" Application Note. External bypass capacitors of 100 pF, 1000 pF and 2.2 μF are required.	
16	RFOUT	This pin is AC coupled and matched to 50 Ohms.	
23, 21, 19	Vdd1, Vdd2, Vdd3	Power Supply Voltage for the amplifier. External bypass capacitors of 100 pF, 1000pF, and 2.2 μF are required.	

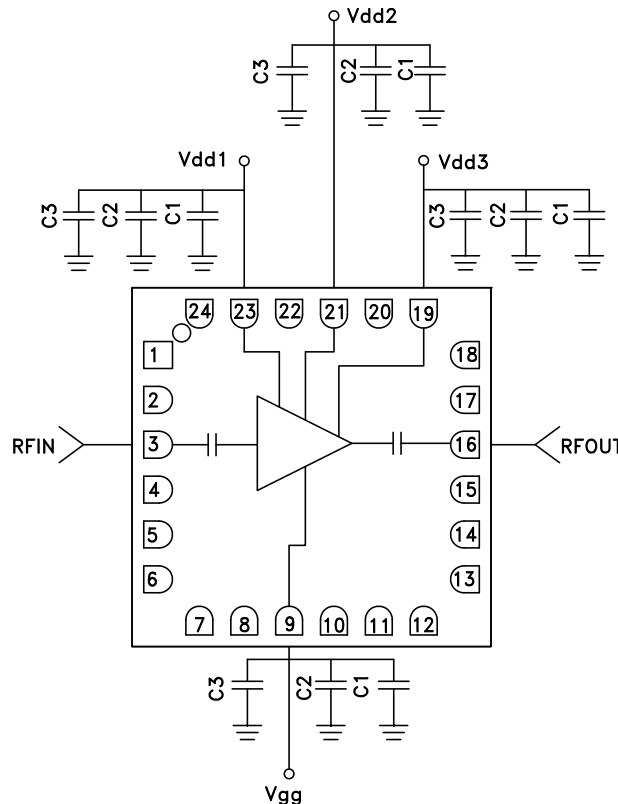
**Application Circuit**

### Evaluation PCB

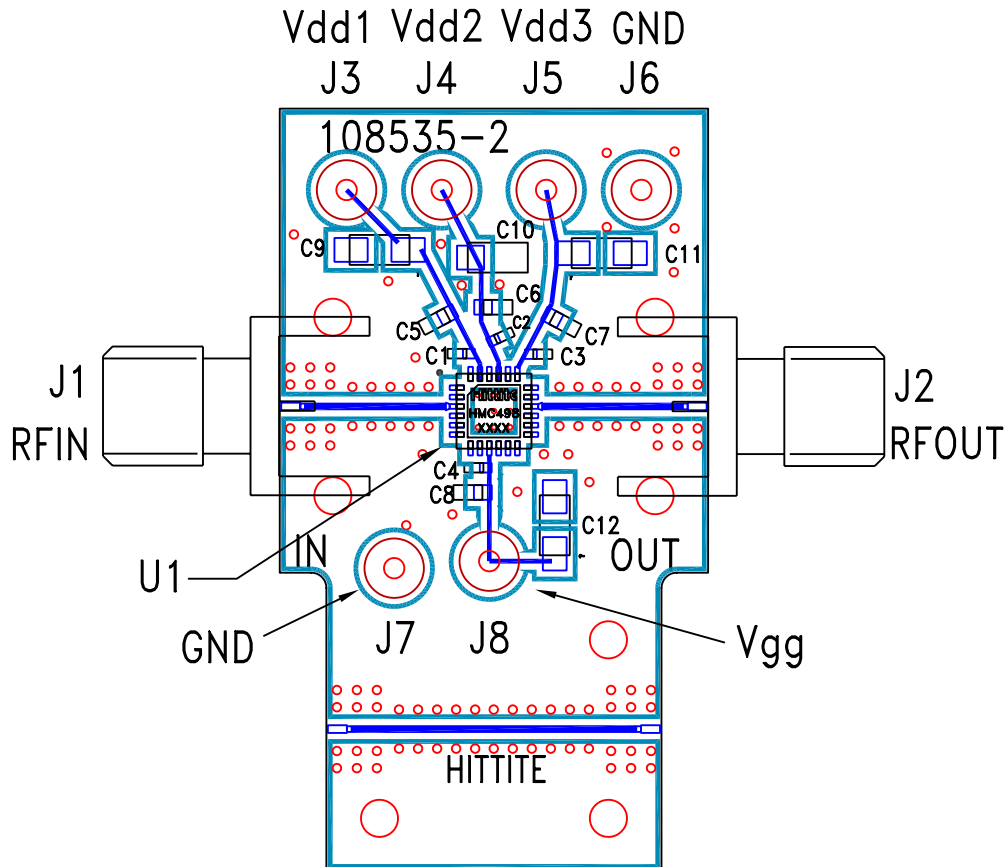

### List of Materials for Evaluation PCB 108537 <sup>[1]</sup>

Item	Description
J1, J2	2.92 mm PC mount K-connector
J3 - J8	DC Pin
C1 - C4	100 pF capacitor, 0402 pkg.
C5 - C8	1,000 pF Capacitor, 0603 pkg.
C9 - C12	2.2µF Capacitor, Tantalum
U1	HMC498LC4 Amplifier
PCB <sup>[2]</sup>	108535 Evaluation PCB

[1] Reference this number when ordering complete evaluation PCB

[2] Circuit Board Material: Rogers 4350.

The circuit board used in this application should use RF circuit design techniques. Signal lines should have 50 Ohm impedance while the package ground leads and exposed paddle should be connected directly to the ground plane similar to that shown. A sufficient number of via holes should be used to connect the top and bottom ground planes. The evaluation board should be mounted to an appropriate heat sink. The evaluation circuit board shown is available from Hittite upon request.