

Analog Devices Welcomes Hittite Microwave Corporation

NO CONTENT ON THE ATTACHED DOCUMENT HAS CHANGED



THIS PAGE INTENTIONALLY LEFT BLANK



HBT GAIN BLOCK MMIC AMPLIFIER, 4 - 10 GHz

Typical Applications

The HMC3587LP3BE is ideal for:

- Cellular / PCS / 3G
- Fixed Wireless & WLAN
- CATV, Cable Modem & DBS
- Microwave Radio & Test Equipment
- IF & RF Applications

Features

- High Output IP3: +25 dBm
- Single Positive Supply: +5V
- Low Noise Figure: 3.5 dB ^[1]
- 12 Lead 3x3 mm SMT Package: 9mm²

Functional Diagram

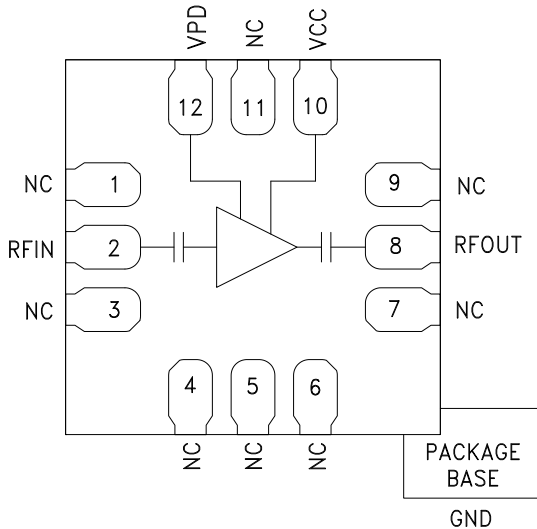

General Description

The HMC3587LP3BE is a HBT Gain Block MMIC amplifier covering 4 GHz to 10 GHz and packaged in a 3x3 mm plastic QFN SMT package. This versatile amplifier can be used as a cascable IF or RF gain stage in 50 Ohm applications. The HMC3587LP3BE delivers 14.5 dB gain, and +13 dBm output P1dB with only 3.5 dB noise figure.

Electrical Specifications, $T_A = +25^\circ C$, $V_{cc} = 5V$, $V_{pd} = 5V$

Parameter	Min.	Typ.	Max.	Min.	Typ.	Max.	Units
Frequency Range	4 - 5		5 - 10				GHz
Gain ^[1]	12.5	14.5		13	15		dB
Gain Variation Over Temperature		0.009			0.012		dB / °C
Input Return Loss		14			12		dB
Output Return Loss		12			13		dB
Output Power for 1 dB Compression (P1dB)	8	11		10.5	13		dBm
Output Third Order Intercept (IP3) (Pout = 0 dBm per tone, 1 MHz spacing)		23			25		dBm
Noise Figure ^[1]		4.5	6		3.5	6	dB
Supply Current 1 (Icc)		43	60		43	60	mA
Supply Current 2 (Ipd)		4	5		4	5	mA

[1] Board loss subtracted out.

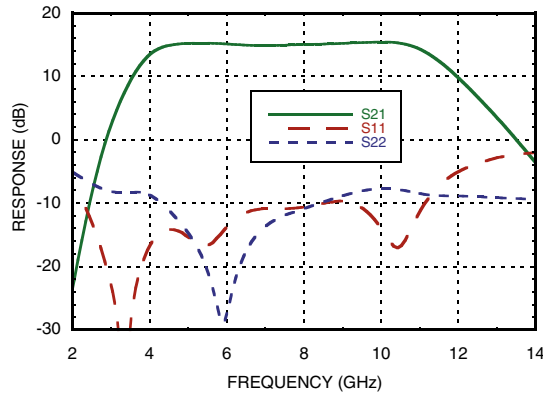
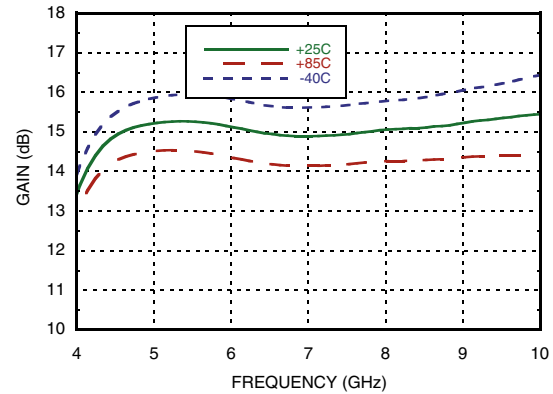
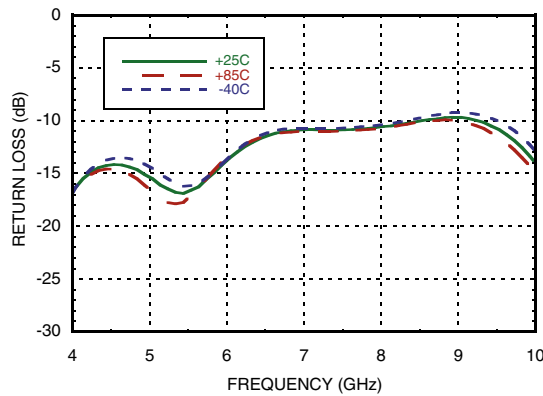
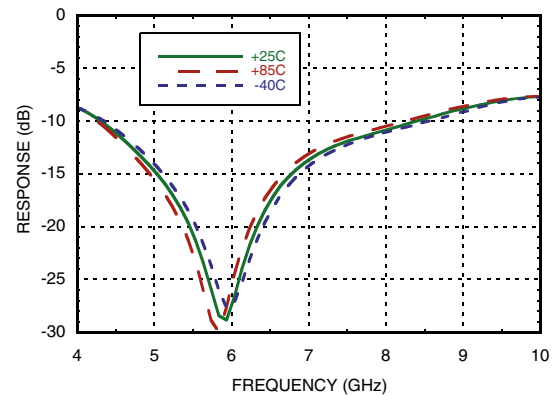
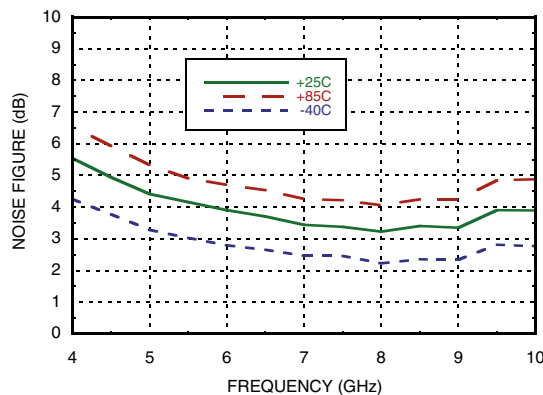
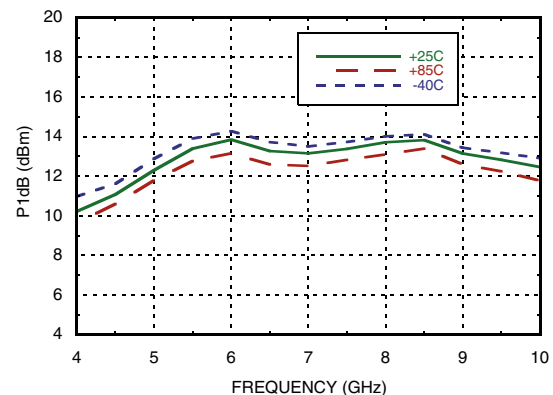
Gain & Return Loss

Gain vs. Temperature

Input Return Loss vs. Temperature

Output Return Loss vs. Temperature

Noise Figure vs. Temperature

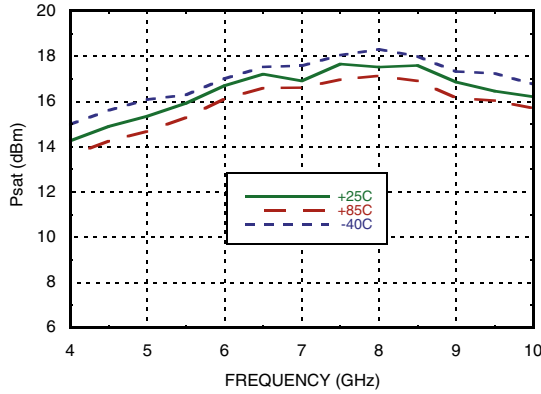
P1dB vs. Temperature



HBT GAIN BLOCK MMIC AMPLIFIER, 4 - 10 GHz

AMPLIFIERS - LINEAR & POWER - SMT

Psat vs. Temperature



Output IP3 vs. Temperature

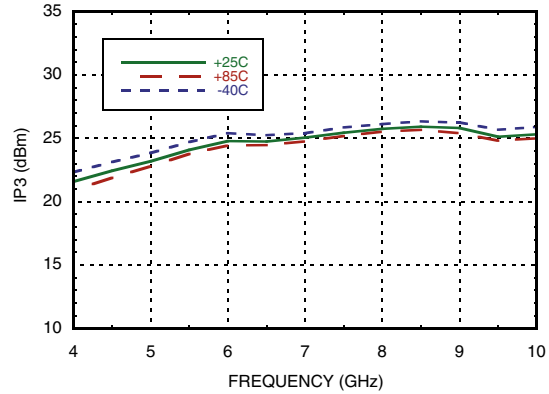

Phase Noise @ Pin=0 dBm

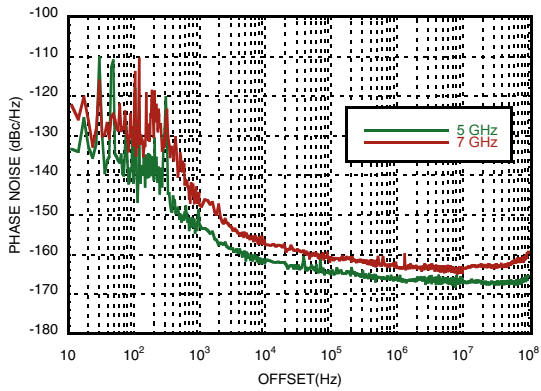

Power Compression @ 5 GHz

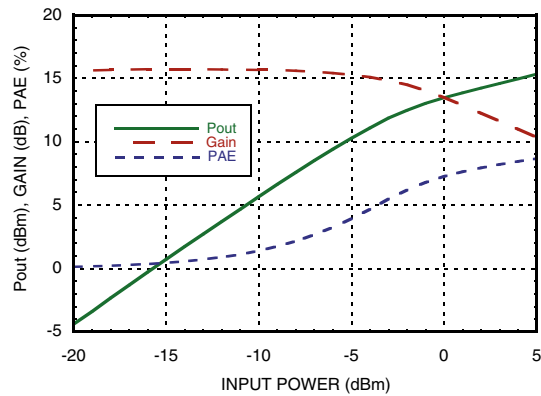

Power Compression @ 7 GHz

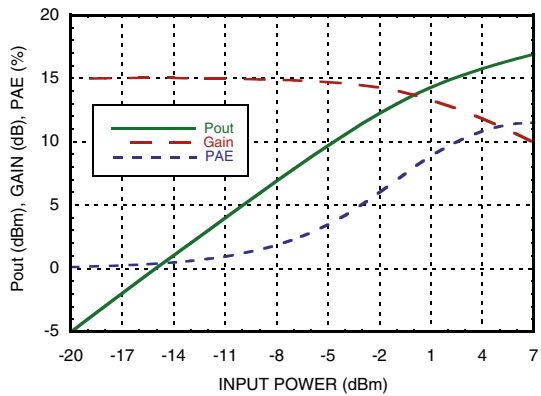

Power Compression @ 9 GHz

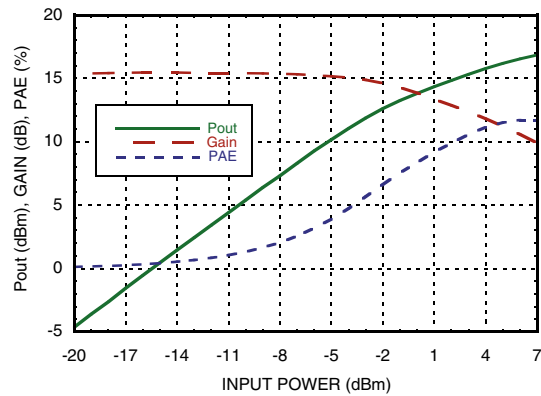

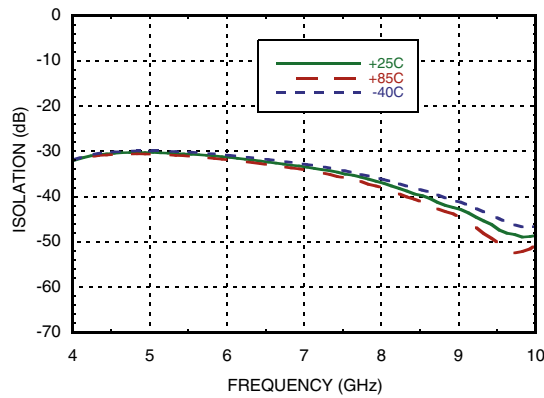
Reverse Isolation

Absolute Maximum Ratings

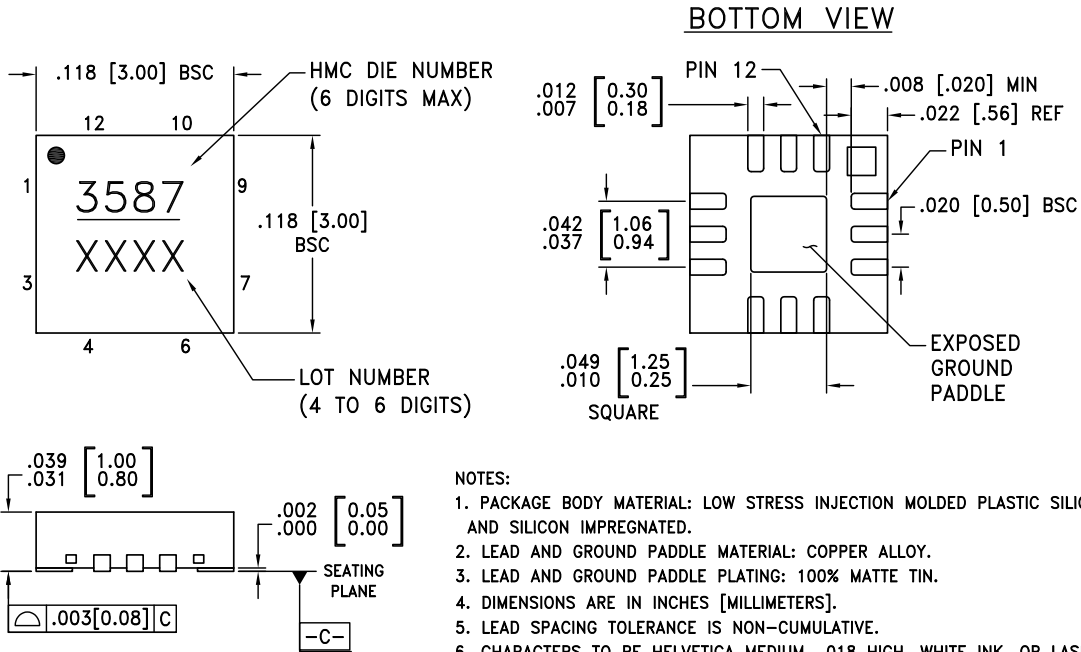
Drain Bias Voltage	6 Vdc
RF Input Power (RFIN)	+12 dBm
Channel Temperature	150 °C
Continuous P _{diss} (T=85 °C) (derate 7.87 mW/ °C Above +85 °C)	512 mW
Thermal Resistance (channel to ground paddle)	127 °C/W
Storage Temperature	-65 to 150 °C
Operating Temperature	-40 to +85 °C
ESD Sensitivity (HBM)	Class 1A

Outline Drawing

NOTES:

1. PACKAGE BODY MATERIAL: LOW STRESS INJECTION MOLDED PLASTIC SILICA AND SILICON IMPREGNATED.
2. LEAD AND GROUND PADDLE MATERIAL: COPPER ALLOY.
3. LEAD AND GROUND PADDLE PLATING: 100% MATTE TIN.
4. DIMENSIONS ARE IN INCHES [MILLIMETERS].
5. LEAD SPACING TOLERANCE IS NON-CUMULATIVE.
6. CHARACTERS TO BE HELVETICA MEDIUM, .018 HIGH, WHITE INK, OR LASER MARK LOCATED APPROX. AS SHOWN.
7. PAD BURR LENGTH SHALL BE 0.15mm MAX. PAD BURR HEIGHT SHALL BE 0.05mm MAX.
8. PACKAGE WARP SHALL NOT EXCEED 0.05mm
9. ALL GROUND LEADS AND GROUND PADDLE MUST BE SOLDERED TO PCB RF GROUND.
10. REFER TO HITTITE APPLICATION NOTE FOR SUGGESTED PCB LAND PATTERN.

Package Information

Part Number	Package Body Material	Lead Finish	MSL Rating ^[2]	Package Marking ^[1]
HMC3587	RoHS-compliant Low Stress Injection Molded Plastic	100% matte Sn	MSL1	H3587 XXXX

[1] 4-Digit lot number XXXX

[2] Max peak reflow temperature of 260 °C

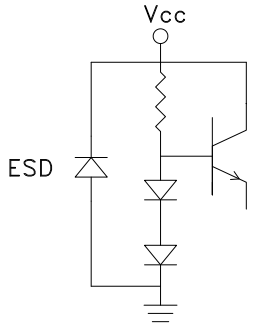
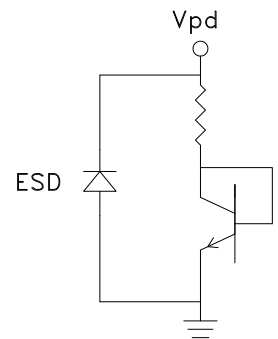

Pin Descriptions

Pid Number	Function	Description	Interface Schematic
1, 3, 4, 5, 6, 7, 9, 11	NC	No connection nenscessary. These pins may be connected to RF/DC ground. Performance will not be affected.	
2	RFIN	This pin is AC coupled and matched to 50 Ohms.	RFIN ○ — —
8	RFOUT	This pin is AC coupled and matched to 50 Ohms.	— — ○ RFOUT
10	Vcc	Power supply voltage for the amplifier	
12	Vpd	Power Control Pin for proper control bias	
GND Paddle	GND	Ground Paddle must be connected to RF/DC ground.	○ GND

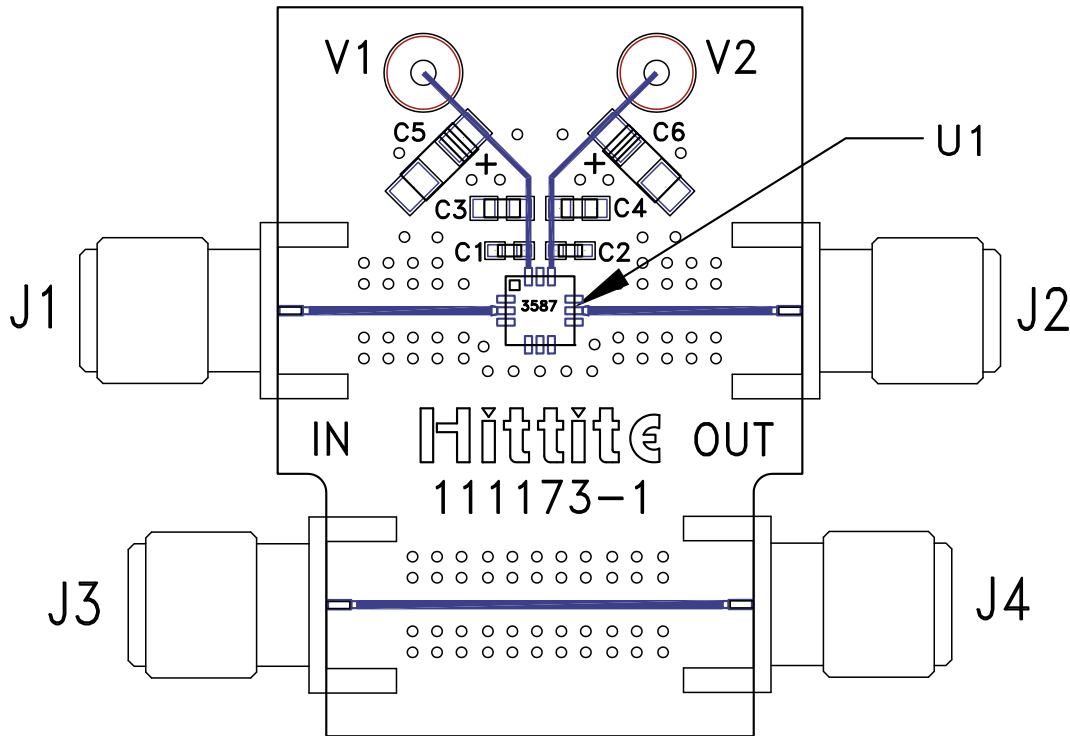
Evaluation PCB

List of Material for Evaluation PCB EVAL01-HMC3587LP3BE ^[1]

Item	Description
J1, J4	PCB Mount SMA RF Connector
C1 - C2	10 pF Capacitor, 0402 Pkg.
C3 - C4	10000 pF Capacitor, 0603 Pkg.
C5 - C6	4.7 uF Capacitor, Tantalum.
U1	HMC3587LP3BE
PCB ^[2]	111173-1 Evaluation Board

^[1] Reference this number when ordering complete evaluation PCB

^[2] Circuit Board Material: Rogers 4350 or Arlon 25FR

The circuit board used in the application should use RF circuit design techniques. Signal lines should have 50 Ohm impedance while the package ground leads and exposed paddle should be connected directly to the ground plane similar to that shown. A sufficient number of via holes should be used to connect the top and bottom ground planes. The evaluation circuit board shown is available from Hittite upon request.

**Application Circuit**