

MICRO-INFINITY[®]

ICN77000 Series Controller

Operator's Manual



THE NEW STANDARD FOR QUALITY



 **NEWPORT** Electronics, Inc.

<http://www.newportUS.com/manuals>





Additional Products from

NEWPORT Electronics, Inc.

THE NEW STANDARD FOR QUALITY

Counters
Frequency Meters
PID Controllers
Clock/Timers
Printers
Process Meters
On/Off Controllers

Recorders
Relative Humidity
Transmitters
Thermocouples
Thermistors
Wire
Rate Meters

Timers
Totalizers
Strain Gauge Meters
Voltmeters
Multimeters
Soldering Iron Testers
pH Pens

pH Controllers
pH Electrodes
RTDs
Thermowells
Flow Sensors

For Immediate Assistance

In the U.S.A. and Canada: 1-800-NEWPORT®

In Mexico: (95) 800-NEWPORTSM

Or call your local NEWPORT Office.

NEWPORTnetSM On-Line Service
www.newportUS.com

Internet e-mail
info@newportUS.com

It is the policy of NEWPORT to comply with all worldwide safety and EMC/EMI regulations that apply. NEWPORT is constantly pursuing certification of its products to the European New Approach Directives. NEWPORT will add the CE mark to every appropriate device upon certification.

The information contained in this document is believed to be correct but NEWPORT Electronics, Inc. accepts no liability for any errors it contains, and reserves the right to alter specifications without notice.

WARNING: These products are not designed for use in, and should not be used for, patient connected applications.

TRADEMARK NOTICE: **NEWPORT**, **NEWPORT**, newportUS.com, **INFINITY**, **MICRO-INFINITY**, and the "Meter Case Bezel Design" are trademarks of NEWPORT Electronics, Inc.

PATENT NOTICE: The "Meter Case Bezel Design" is a trademark of NEWPORT Electronics, Inc., registered in the U.S. This product is covered by one or more of the following patents: U.S. Pat. No. D336,895; 5,274,577/ FRANCE BREVET No. 91 12756/ UK PATENT No. GB2 248 954; GB2 249 837/ SPAIN 2039150; 2048066/ ITALY 1249456; 1250938/ CANADA 2052599; 2052600/ GERMANY DE 4134398 C2. OTHER U.S. AND INTERNATIONAL PATENTS PENDING OR APPLIED FOR.



This device is marked with the international caution symbol. It is important to read the Setup Guide before installing or commissioning this device as it contains important information relating to safety and EMC.

To Order Model ICN77000 SERIES CONTROLLER (Specify Model Number)

PROCESS CONTROLLER, DUAL DISPLAY FOR THERMOCOUPLE, RTD, VOLTAGE OR CURRENT INPUTS IN A 1/16 DIN CASE

Model No. Description	Model No. Description <i>cont.</i>
<p>ICN77 Dual displays for simultaneous display of measured value and setpoint. Selectable preset tune, adaptive tune, autotune, PID, PI, PD control modes. The dual control outputs can be configured for a variety of control and alarm applications such as heat, heat/cool, heat/alarm, cool or cool/alarm. The ramp to setpoint feature allows the user to define the rate of rise to setpoint, minimizing thermal shock to the load during start-up. Maximum ramp time 99.59 (HH.MM), Soak: 00.00 to 99.59 (HH.MM), Damping: 1 to 8 in unit steps. Input types J,K,T,E,R,S,B,N,J-DIN°C, RTD 100Ω 0.00385, 100Ω & 1kΩ 0.00392, 0 to 20 mA, 4 to 20 mA, 0 to 100mV, 0 to 1V, 0 to 10Vdc. Alarm 1 output includes SPST relay, 3A @ 120Vac, 3A @ 240Vac.</p> <p>NOTE: The Controller must be ordered completely configured. Options are not field installable.</p>	<p>[] OPTIONAL OUTPUTS * none (no entry required) -A2 SPST relay, 3A@ 120Vac, 3A @ 240Vac (Alarm 2) -C2 Isolated RS232, 300 to 19.2k baud -C4 Isolated RS485, 300 to 19.2k baud -PV Isolated Analog Output -RSP Remote Setpoint Selection</p> <p>[] POWER SUPPLY * 90 to 240 Vac/dc, 50 to 400Hz (no entry required)</p>
<p>[] CASE TYPE R3 NEMA 1, 1.89 x1.89" (48 x 48mm) bezel and 1.75" ROUND cutout R5 NEMA 1, 2.1 x 2.1" bezel and 1.75" ROUND cutout 3 NEMA 12 bezel for 1/16 DIN panel cutout 45mm x 45mm (1.772 x 1.772") 5 NEMA 4 bezel for 1/16 DIN panel cutout 45mm x 45mm (1.772 x 1.772")</p>	<p><u>NEMA 1/UL Type 1:</u> Intended for indoor use, to provide a degree of protection against contact with the enclosed equipment and against limited amount of falling dirt.</p> <p><u>NEMA 4/UL Type 4:</u> Intended for indoor use, to provide a degree of protection against splashing water, windblown dust and rain, and hose directed water and undamaged by the formulation of ice on the enclosure. <u>Testing-Hosedown:</u> Enclosure is subjected to a stream of water from a hose which has a 1" diameter nozzle and which delivers at least 65 gallons per minute from a distance of 10 to 12 feet for a minimum of 5 minutes.</p>
<p>[] CONTROL OUTPUT #1 (Direct or Reverse Acting) 2 Solid State Relay SSR : 1A @ 120/240Vac continuous 3 Relay: Form "C" 5A @ 120Vac, 3A @ 240Vac 4 Pulsed 10Vdc @20mA (for use with external SSR) 5 Non-Isolated 1 to 10Vdc or 0-20mA @500Ω max</p>	<p><u>NEMA 12/UL Type 12:</u> Intended for indoor use, to provide a degree of protection against circulating dust, falling dirt, and dripping non-corrosive liquids. <u>Testing-Drip:</u> Enclosure is subjected to a drip pan which produces both splashing and dripping. <u>Testing-Atomized Water:</u> Enclosure is subjected to a spray of atomized water by using a nozzle that produces a 3" round diameter spray, 12" from enclosure. The air pressure is at 30psi.</p>
<p>[] CONTROL OUTPUT #2 (Direct or Reverse Acting) 0 Insert "0" if second output is not desired 2 Solid State Relay SSR: 1A @ 120/240Vac continuous 3 Relay: Form "C" 5A @ 120Vac, 3A @ 240Vac 4 Pulsed 10Vdc @20mA (use for external SSR)</p>	<p>For harsh environments, we recommend installation of the controller for square panel cutouts.</p>

Ordering Examples:

- 1.) **ICN77R322-C2** is a NEMA 1 bezel case with 1.75 inch round hole mounting adaptor, dual SSR control outputs and RS232 communications output.
- 2.) **ICN77330** is a NEMA 12 bezel case with 1/16 DIN mounting and single Relay control output.
- 3.) **ICN77544-A2** is a NEMA 4 bezel case with 1/16 DIN mounting, dual pulse control outputs, and a SPST 3A Alarm relay.



NOTES



TABLE OF CONTENTS



Part 1: Introduction

1.1	Safety Considerations	1
1.2	Before You Begin	2

Part 2: Setup

2.1	Mounting the Controller	4
2.2	Front Panel View	7
	<i>Front Panel Annunciators</i>	7
2.3	Rear Panel View	8
	<i>Rear Panel Connector Labels</i>	9
2.4	Mechanical Installation	10
	<i>Dip Switch Configuration</i>	10
	<i>Dip Switch Settings</i>	11
2.5	Electrical Installation	12
	<i>Input Connection Examples</i>	13
2.5.1	Thermocouple.....	13
2.5.2	Two/Three/Four Wire RTD	14
2.5.3	Process Current	15
2.5.4	Process Voltage	15



TABLE OF CONTENTS

Part 3: Operation: Configuration Mode

3.1	Introduction	16
	<i>Turning Your Controller on for the First Time</i>	16
	<i>Function in Configuration Mode</i>	17
3.2	Menu Configuration	18
	<i>ID Number</i>	19
	<i>Set Points</i>	20
	<i>Input Type (Thermocouple)</i>	24
	<i>Input Type (RTD)</i>	25
	<i>Input Type (RTD Value)</i>	26
	<i>Input Type (Process)</i>	27
	<i>Reading Configuration</i>	29
	<i>Alarm 1</i>	33
	<i>Alarm 2</i>	36
	<i>Loop Break Alarm</i>	38
	<i>Output 1</i>	42
	<i>Output 2</i>	52
	<i>Ramp & Soak</i>	58
3.3	Available Options	60
	<i>Analog Output Option</i>	61
	<i>Communication Option</i>	64



Configuration Mode Cont.

Command Formats72
Reading Scale86
Reading Offset87
Remote Setpoint Option88

Part 4 Specifications.....91

List of Figures

Figure 2.1 a. — Mounting the Square Mount Controller5
 Figure 2.1 b. — Mounting the Round Mount Controller6
 Figure 2.2 — Front Panel Display7
 Figure 2.3 — Typical Rear Connector Label and Possible Labels of Different Models8
 Figure 2.4 — Dip Switch Location10
 Figure 2.5.1 — Power Wiring Hookup12
 Figure 2.5.2 — Thermocouple Wiring Hookup13
 Figure 2.5.3 — Two-wire RTD Hookup, Three-Wire RTD Hookup, Four -Wire RTD Hookup14
 Figure 2.5.4 — Process Current Wiring Hookup15
 Figure 2.5.5 — Process Voltage Wiring Hookup15
 Figure 3.1 — Flowchart for ID and Set Point Menus18
 Figure 3.2 — Flowchart for Input Type23
 Figure 3.3 — Flowchart for Reading Configuration28



TABLE OF CONTENTS

List of Figures *Cont.*

Figure 3.4 — Flowchart for Alarm 1 and Alarm 2.....	32
Figure 3.5 — Flowchart for Loop Break.....	37
Figure 3.6 — Flowchart for Output 1.....	41
Figure 3.7 — Flowchart for Output 2.....	51
Figure 3.8 — Flowchart for Ramp & Soak.....	57
Figure 3.9 — Flowchart for Analog Output Option.....	61
Figure 3.10 — Flowchart for Communication Option.....	64
Figure 3.11 — Flowchart for Remote Setpoint.....	88

List of Tables

Table 3.1 — Communication Commands.....	72
Table 3.2 — Command Letters and Index.....	76

1.1 Safety Considerations



This device is marked with the international caution symbol. It is important to read this manual before installing or commissioning this device as it contains important information relating to Safety and EMC (Electromagnetic Compatibility).

This instrument is a panel mount device protected in accordance with Class I of EN 61010 (115/230 AC power connections). Installation of this instrument should be done by qualified personnel. In order to ensure safe operation, the following instructions should be followed.



This instrument has no power-on switch. An external switch or circuit-breaker shall be included in the building installation as a disconnecting device. It shall be marked to indicate this function, and it shall be in close proximity to the equipment within easy reach of the operator. The switch or circuit-breaker shall meet the relevant requirements of IEC 947-1 and IEC 947-3 (International Electrotechnical Commission). The switch shall not be incorporated in the main supply cord.



Furthermore, to provide protection against excessive energy being drawn from the main supply in case of a fault in the equipment, an overcurrent protection device shall be installed.

- Do not exceed voltage rating on the label located on the top of the instrument housing.
- Always disconnect power before changing signal and power connections.
- Do not use this instrument on a work bench without its case for safety reasons.
- Do not operate this instrument in flammable or explosive atmospheres.
- Do not expose this instrument to rain or moisture.
- Unit mounting should allow for adequate ventilation to ensure instrument does not exceed operating temperature rating.
- Use electrical wires with adequate size to handle mechanical strain and power requirements. Install without exposing bare wire outside the connector to minimize electrical shock hazards.

EMC Considerations

- Whenever EMC is an issue, always use shielded cables.
- Never run signal and power wires in the same conduit.
- Use signal wire connections with twisted-pair cables.
- Install Ferrite Bead(s) on signal wires close to the instrument if EMC problems persist.

Failure to follow all instructions and warnings may result in injury!

Customer Service

Inspecting Your Shipment

Manuals, Software:

1.2 Before You Begin

If you need assistance, please contact the nearest Customer Service Department, listed in this manual.

Remove the packing slip and verify that you have received everything listed.

Inspect the container and equipment for signs of damage as soon as you receive the shipment. Note any evidence of rough handling in transit. Immediately report any damage to the shipping agent. The carrier will not honor damage claims unless all shipping material is saved for inspection. After examining and removing the contents, save the packing material and carton in the event reshipment is necessary.

The latest Operation and Communication Manual as well as free configuration software are available from **the website listed in this manual or on the CD-ROM enclosed with your shipment.**

 **Tip** ESR

For first-time users: Refer to the QuickStart Manual for basic operation and set-up instructions.

If you have the Serial Communications Option you can easily configure the controller on your computer or on-line.

TO DISABLE OUTPUTS

Standby mode is useful during setup of the controller or when maintenance of the system is necessary. When the controller is in standby, it remains in the ready condition but all outputs are disabled. This allows the system to remain powered and ready to go.

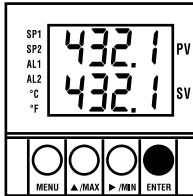

When the controller is in "RUN" Mode, **push ENTER twice to disable all outputs and alarms.**

It is now in "STANDBY" Mode. Push ENTER once more to resume "RUN" Mode.

Tip

PUSH ENTER TWICE to disable the system during an **EMERGENCY**.

2.1 Mounting the Controller

Note E30

If necessary, the rear connector assembly may be removed from the main case for wiring (see Figure 2.1a for Square Mount, Figure 2.1b for Round Mount).

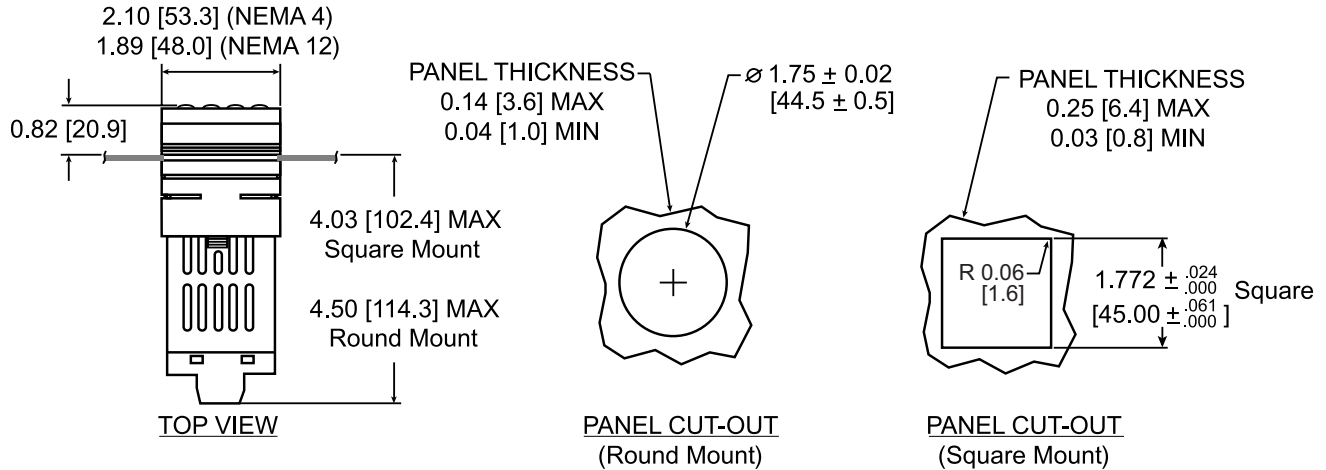

Square Mount Micro Controller Mounting Instructions

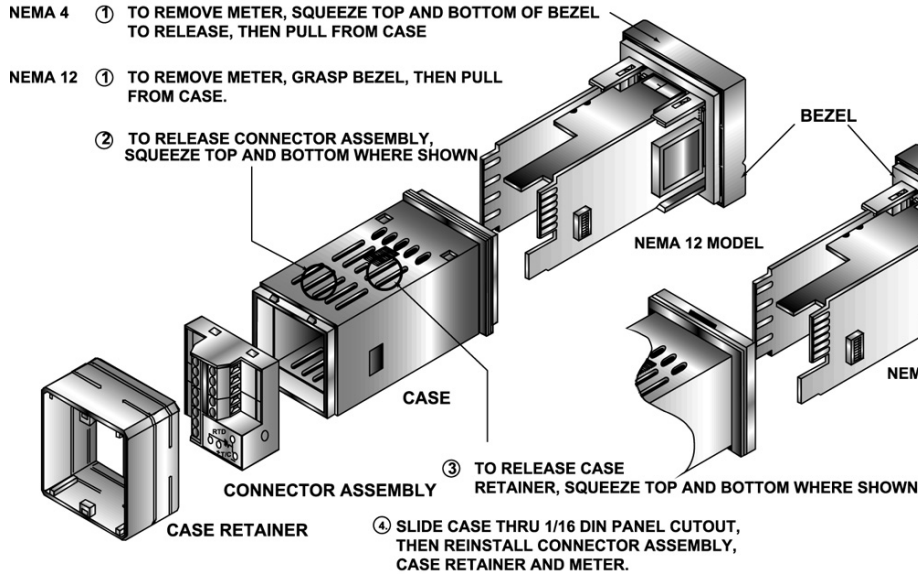

Figure 2.1a — Mounting the Square Mount Controller

Round Mount Micro Controller Mounting Instructions

1. Separate the display from the meter by squeezing the case (where shown) and then unplugging the cable from the meter.
2. Slide the retainer over the rear of the case, but do not engage serrations on case.
3. Pass the cable (from the display) thru a 1 3/4" diameter hole in the mounting panel and connect to the meter (take care to center the connector on the mating pins). While squeezing the case, press the display and meter squarely together until they connect.
4. Check the display and gasket for proper alignment, then slide the retainer tight against the backside of the mounting panel.

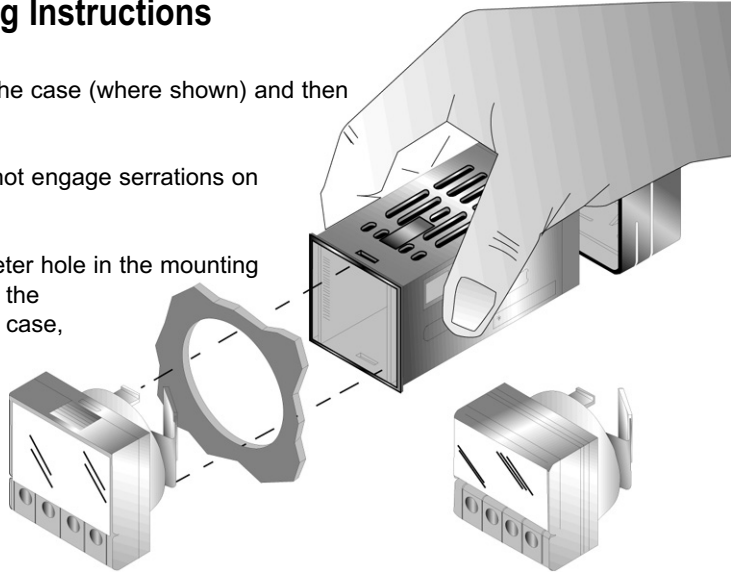

Figure 2.1b — Mounting the Round Mount Controller

2.2. Front Panel View

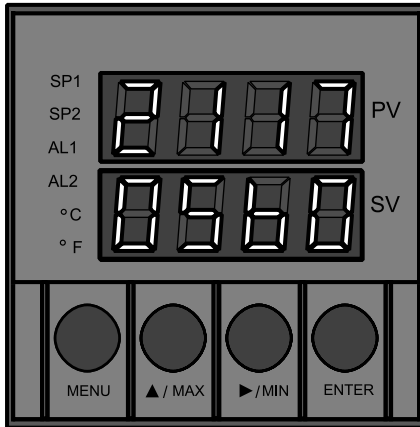

Figure 2.2 Front Panel Display

Front Panel Annunciators

SP1	OUT1/Setpoint 1 indicator.
SP2	OUT2/Setpoint 2 indicator.
AL1	Alarm 1 indicator.
AL2	Alarm 2 indicator.
°C	°C unit indicator.
°F	°F unit indicator.
PV	Upper display shows the Process Value
SV	Lower display shows the Setpoint Value
MENU	Changes display to Configuration Mode and advances thru menu items*
▲/MAX	Used in program mode and peak recall*
►/MIN	Used in program mode and valley recall*
ENTER	Accesses submenus in Configuration Mode and stores selected values*

* See Part 3 Operation: Configuration Mode

2.3. Rear Panel View

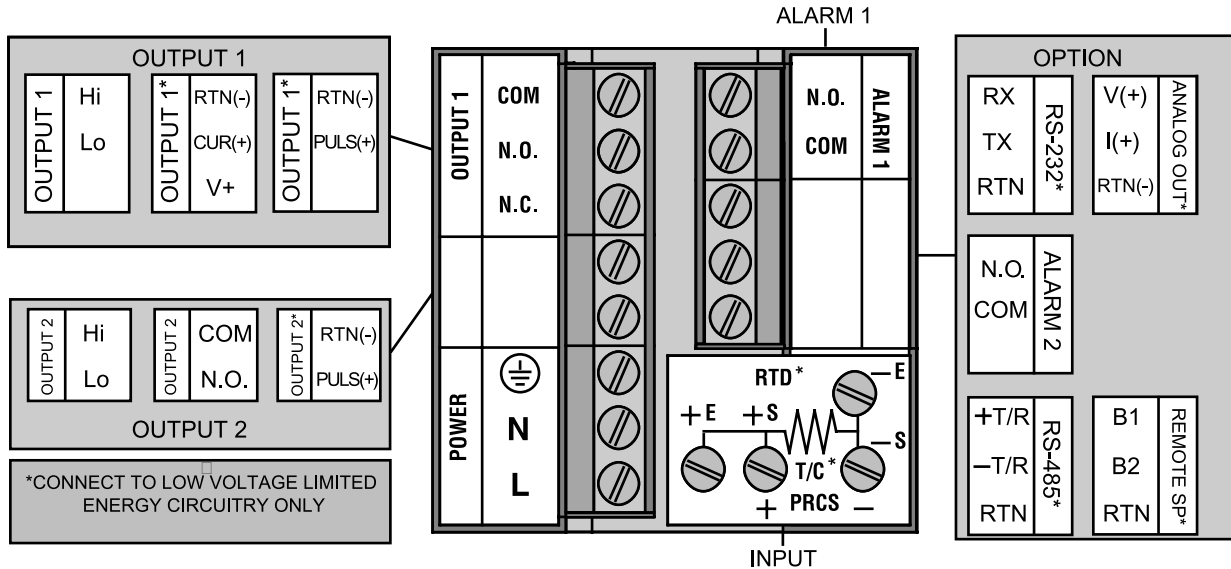

Figure 2.3 Typical Rear Connector Label and Possible Labels of Different Models

Rear Panel Connector Labels

POWER	AC Power Connector: All models
INPUT	Input Connector: All models TC, PR (Process) RTD
ALARM 1	ALARM 1 relay SPST, programmable: All models
OUTPUT 1	Control Output 1: Based on one of the following models. Relay SPDT Voltage and Current Solid State Relay Pulse
OUTPUT 2	Control Output 2: Based on one of the following models: Relay SPST Normally Open Solid State Relay Pulse
OPTION	Based on one of the following models: RS-232C Isolated Analog Out RS-485 Alarm 2 Relay SPST, programmable Remote Setpoint

2.4. Mechanical Installation

Dip Switch Configuration

The settings of the DIP switch must be verified or set to comply with your selection at the Input/Type menu (see Section 3.0 for Input/Type). The DIP switch is accessible through an opening on the side of the case or may be accessed by removing the controller from the case, see Section 2.1 for instructions. Locate the dip switch (see Figure 2.4) and set the switches according to the following tables.

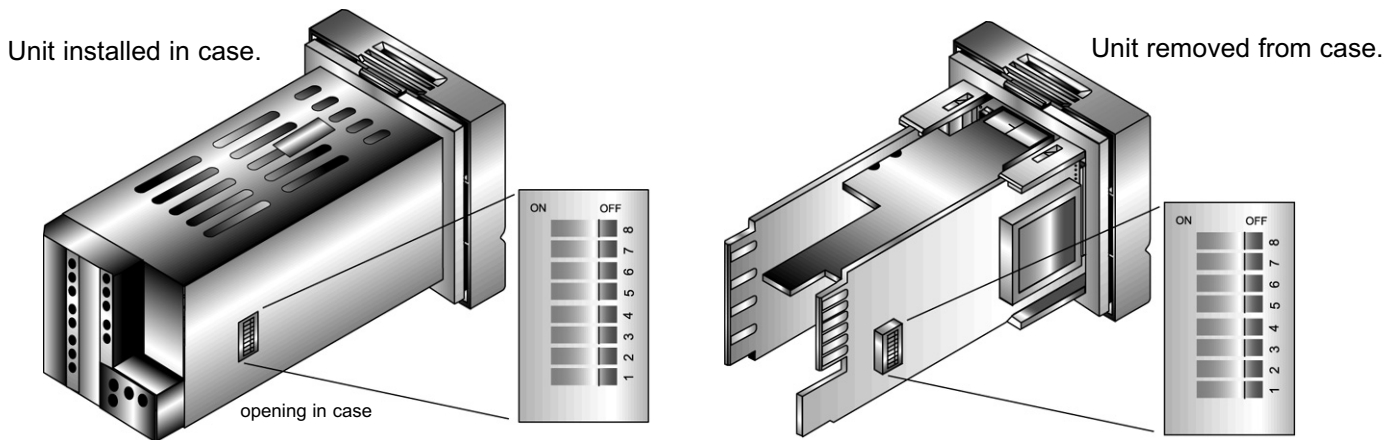
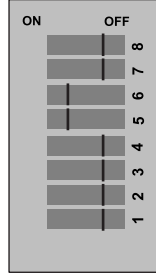

Figure 2.4 Dip Switch Location — switch settings are shown in OFF position

Dip Switch Settings

Thermocouple



RTD 100

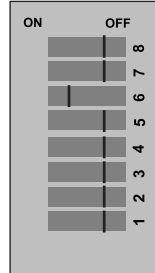

RTD 500/1k ohm

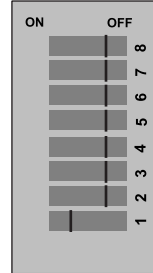

Process 20mA

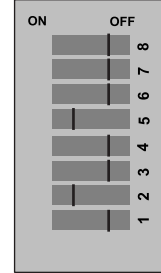

Process 100mV

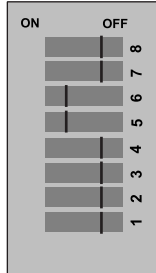

Process 1V

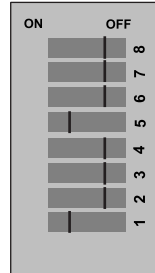

Process 10V

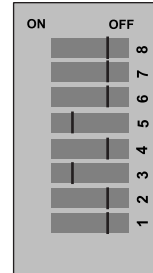

For SSR wiring hook-up examples, refer to Specification Section.

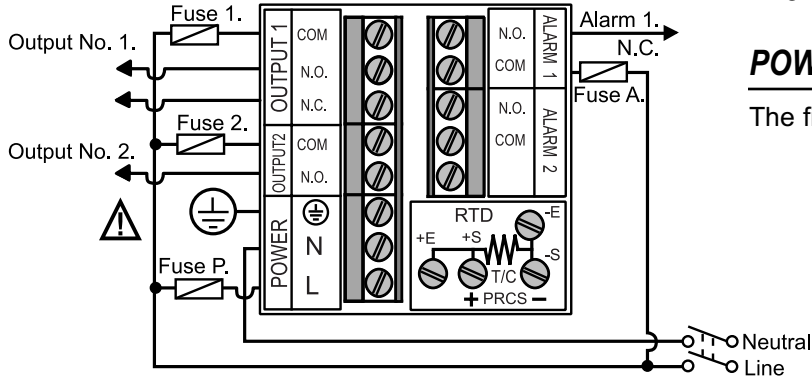

Figure 2.5.1 Power Wiring Hookup

Note

The Safety European Standard EN61010-1 for measurement, control, and laboratory equipment requires that fuses must be specified based on IEC127. This standard specifies for a Time-lag fuse, the letter code "T". The above recommended fuses are of the type IEC127-2-sheet III. Be aware that there are significant differences between the requirements listed in the UL 248-14/CSA 248.14 and the IEC 127 fuse standards. As a result, no single fuse can carry all approval listings. A 1.0 Amp IEC fuse is approximately equivalent to a 1.4 Amp UL/CSA fuse. It is advised to consult the manufacturer's data sheets for a cross-reference.

2.5. Electrical Installation

POWER CONNECTION EXAMPLES

The figure below shows the power wiring hookup.



Use copper conductors only for power connections



The Protective Conductor terminal must be connected for safety reasons.

Fuse	Connector	Output Type	115 Vac	230 Vac
Fuse 1	Output 1	Relay	5 A(T)	3 A(T)
Fuse 2	Output 1	Relay	5 A(T)	3 A(T)
		SSR	0.5 A(T)	0.5 A(T)
Fuse P	Power	N/A	100 mA(T)	100 mA(T)
Fuse A	Alarm 1/2	Relay	3 A(T)	3 A(T)

Note: Values shown are minimum recommendations for the protection of the controller. For a specific load, consult the respected electrical specifications to select a suitable fuse.

INPUT CONNECTION EXAMPLES

2.5.1. Thermocouple

The figure below shows the wiring hookup for any thermocouple type. For example, for Type K hookup, connect the yellow wire to the + (+S) Terminal and the red wire to the – (–S) Terminal. **When configuring your controller, select Thermocouple and Thermocouple type in the Input Type menu (see part 3).**

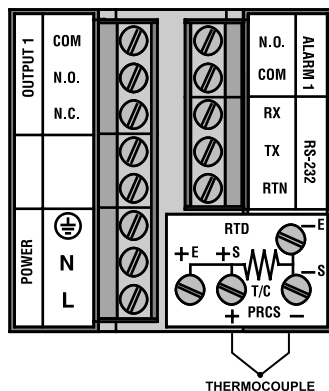

TYPE	Input Connector		Jacket (external insulation)	
	Terminal 1 (-)	Terminal 2 (+)	Extension	Grade
J	Red	White	dark-Brown	Black
K	Red	Yellow	dark-Brown	Yellow
T	Red	Blue	dark-Brown	Blue
E	Red	Purple	dark-Brown	Purple
N	Red	Brown	dark-Brown	Brown
R	Red	Black	-	Green
S	Red	Black	-	Green
B	Red	Black	-	Black

Figure 2.5.2 Thermocouple Wiring Hookup

2.5.2. Two/Three/Four-Wire RTD

The figures below show the input connections and input connector jumpers required to hookup a 2, 3 or 4-wire RTD.

The **two-wire** connection is the simplest method, but does not compensate for lead-wire temperature change and often requires calibration to cancel lead-wire resistance offset.

The **three-wire** connection works best with RTD leads closely equal in resistance. The controller measures the RTD, plus upper and lower lead drop voltage and then subtracts twice the measured drop in the lower supply current lead producing excellent lead-resistance cancellation for balanced measurements.

The **four-wire** RTD hookup is applicable to unbalanced lead resistance and enables the controller to measure and subtract the lead voltage which produces the best lead-resistance cancellation. When configuring your controller, select RTD type and RTD value in the Input Type Menu (see part 3).

Figure 2.5.3

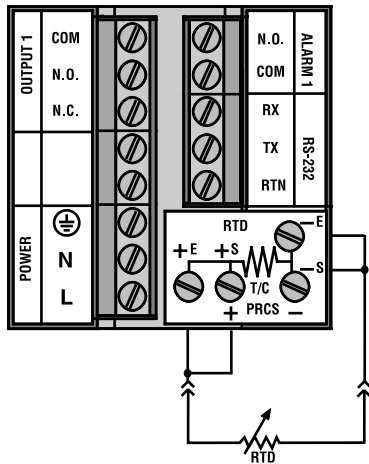

Two-Wire RTD Hookup

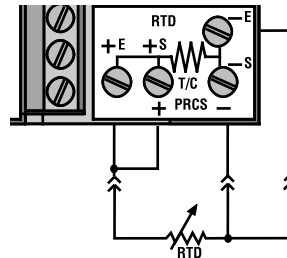

Three-Wire RTD Hookup

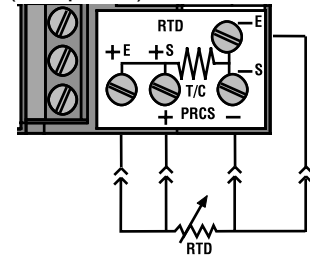

Four-Wire RTD Hookup

2.5.3. Process Current

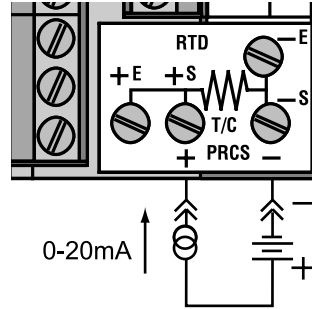

The figure shows the wiring hookup for Process Current 0 - 20 mA.

When configuring your controller, select Process type in the Input Type menu (see part 3).

Figure 2.5.4 Process Current Wiring Hookup

2.5.4. Process Voltage

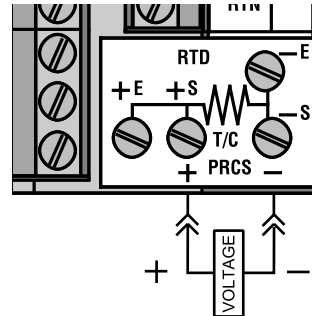

The figure shows the wiring hookup for Process Voltage 0 - .1 V, 0 - 1 V, or 0 -10 V.

When configuring your controller, select Process type in the Input Type menu (see part 3).

Figure 2.5.5 Process Voltage Wiring Hookup

3.1 Introduction

The Controller has two different modes of operation. The first, *Run Mode*, is used to display values for the process variable, setpoint value and to display or clear peak and valley values. The other mode, *Menu Configuration Mode*, is used to navigate through the menu options and configure the controller.

Part 3 of this manual will explain the *Menu Configuration Mode*. **For your controller to operate properly, the user must first "program" or configure the menu options in the *Menu Configuration Mode*.**

Turning Your Controller On for the First Time

The Controller becomes active as soon as it is connected to a power source. It has no On or Off button. The Controller will at first flash reset on the PV and software version number on the SV display, and then proceed to the *Run Mode*.

OPERATION: *CONFIGURATION MODE*

Button	Function in Configuration Mode
MENU	To enter the Configuration Mode, the user must first press MENU. Use this button to advance/navigate to the next setting. The first menu to appear will be "ID Code", if enabled. The user can navigate through all the top level menus by pressing MENU. Selecting an ID of 0000 will allow you to bypass the ID Menu using the MENU button.
▲/MAX	Press this button to scroll through "flashing" selections. When a numerical value is flashing, this button will increase the active digit from "0" to "9". After "9" the display starts at "0" again. The most significant digit may also show a "-" sign. In the Run Mode MAX causes the display to flash the PEAK - press again to return to the PV value.
▶/MIN	Press this button to go back to a previous Top Level Menu item. Press this button twice to reset the controller to the <i>Run Mode</i> . When a numerical value is flashing, this button will scroll through the digits from left to right digit allowing the user to select the desired digit to modify. In the Run Mode, MIN causes the display to flash the VALLEY - press again to return to the PV value.
ENTER	Press this button to access the submenus from a Top Level Menu item. Also, press this button to store a submenu selection or after entering a value — the display will flash a "stored" message to confirm your selection. To reset flashing PEAK or VALLEY press ENTER. In the Run Mode, press ENTER twice to enable Standby Mode with flashing "Stby".
NOTE:	Except for Setpoints and the Alarms, modifying any settings of the menu configuration will reset the controller prior to resuming Run Mode.

3.2 Menu Configuration: *Modifying set points will not reset the controller*

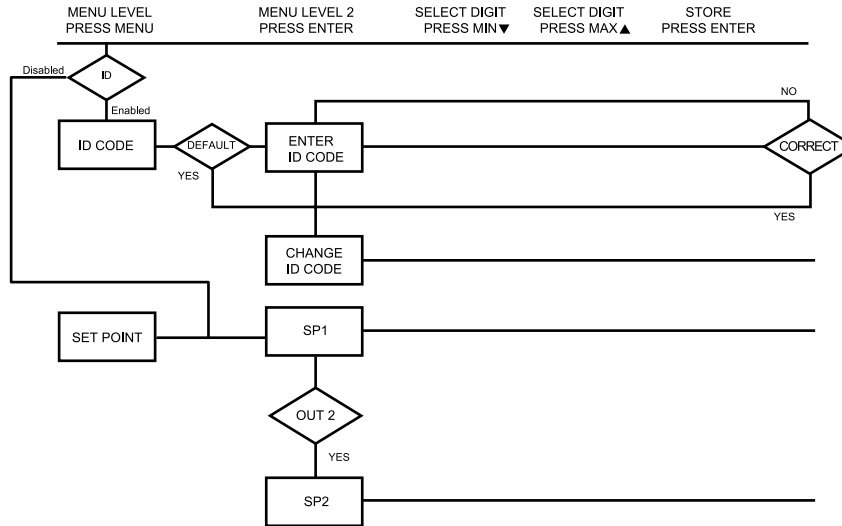

Figure 3.1 Flowchart for ID and Set Point Menus

OPERATION: CONFIGURATION MODE

ID Number (if enabled)

Note ESP

It is recommended that you put the controller in the Standby Mode for any configuration change other than setpoints & alarms

Display	Action	Response
SEE ID OPTION SUBMENU IN THE BREAK LOOP ALARM SECTION FOR ENABLE/DISABLE ID OPTION		

Press MENU
Press ENTER

ENTERING OR CHANGING YOUR (NON-DEFAULT) ID NUMBER

- 1) Press MENU, if necessary, until " **Id CODE**" prompt appears.
- 2) Display advances to " **Id Cd**", if non-default ID code. If default ID code, the menu will advance to **CH Id** with default value i.e. 0000.

Press MAX & MIN

Press ENTER

Note ESP

If the ID code is the default value i.e. 0000, press MENU again and the menu will skip the ID code to Set Point Menu.

- 3) Press MAX to increase digit 0-9. Press MIN to activate next digit (flashing). Continue to use MAX and MIN to enter your 4-digit ID code.
- 4) If the correct ID code is entered, the menu will display **CH Id**, otherwise an error message will be displayed and the controller will return to the Run Mode.

Press MENU
or
Press MAX & MIN

- 5) To leave your ID code **Unchanged**, press MENU and advance to "**Set Point**" Menu. To **Change** your ID code use the MAX and MIN buttons to enter a new ID code.

Press ENTER

- 6) Display flashes "**Strd**" message and advances to the next menu "**Set Point**".





Note ESP

To prevent unauthorized tampering with the setup parameters, the controller provides protection by requiring the user to enter the ID code before allowing access to subsequent menus. If the ID code entered does not match the ID code stored, the controller responds with an error message and access to subsequent menus will be denied.

Tip ESP

Use numbers that are easy for you to remember. If the ID code is forgotten or lost, call customer service with your serial number to reset the default to "0000".

OPERATION: *CONFIGURATION MODE***Set Points (if ID Number Enabled)**

Display	Action	Response
	Press MENU Press ENTER	SETPOINT 1 1) Press MENU, if necessary, until "SEt Pt" prompt appears. 2) Display advances to "SP 1", Setpoint 1.
	Press MAX Press MIN	DISPLAY SHOWS PREVIOUS VALUE. 1ST DIGIT FLASHING. 4) Press MAX to increase digit 0-9. 5) Press MIN to activate next digit (flashing). 6) Continue to use MAX and MIN to enter your 4-digit Setpoint 1 value.
	Press ENTER	7) Display flashes "Strd" message only if a change is made, otherwise press MENU to advance to "SP2", Setpoint 2.
	Press MAX & MIN	SETPOINT 2 : DISPLAY SHOWS PREVIOUS VALUE. 1ST DIGIT FLASHING. 9) Use MAX and MIN buttons to enter your 4-digit Setpoint 2 value.
	Press ENTER	13) Display flashes "Strd" message and advances to "Swapping Setpoints" submenu.

OPERATION: CONFIGURATION MODE



Setpoints cont.

Display	Action	Response																				
		<p>OUTPUT REDIRECTION: DISPLAY SHOWS “5 la1” AND CURRENT SETTING, “5 la1” OR “5 la2”</p> <p>When “5 la1” is selected, Setpoint 1 (and OUT 1 configuration) direct the control output at label “Output 1” and Setpoint 2 (and OUT 2 configuration) direct the control output at label “Output 2.” When “5 la2” is selected, Setpoint 1 (and OUT 1 configuration) direct the control output at label “Output 2” and Setpoint 2 (and OUT 2 configuration) direct the control at label “Output 1.”</p> <table border="0"> <thead> <tr> <th>Summary</th> <th>Setting</th> <th>Setpoint/Out/LED</th> <th>Output Label</th> </tr> </thead> <tbody> <tr> <td></td> <td>5 la1</td> <td>1</td> <td>→ 1</td> </tr> <tr> <td></td> <td></td> <td>2</td> <td>→ 2</td> </tr> <tr> <td></td> <td>5 la2</td> <td>1</td> <td>→ 2</td> </tr> <tr> <td></td> <td></td> <td>2</td> <td>→ 1</td> </tr> </tbody> </table>	Summary	Setting	Setpoint/Out/LED	Output Label		5 la1	1	→ 1			2	→ 2		5 la2	1	→ 2			2	→ 1
Summary	Setting	Setpoint/Out/LED	Output Label																			
	5 la1	1	→ 1																			
		2	→ 2																			
	5 la2	1	→ 2																			
		2	→ 1																			
	Press MAX	14) Press MAX to select the output option.																				
	Press ENTER	15) Press ENTER to make the selection or MENU to advance to “Input Type”.																				

Note

Always put unit in stand-by before redirecting the outputs, and always perform a reset afterward to ensure proper operation. With Analog Proportional output option, the following issues need to be considered when redirecting the output: 1) Current (4-20 mA) output is disabled; 2) %Hi/Lo and SELF setting is moved to Out 2 configuration menu; 3) Control Type and Cycle Time appear in Out 1 and is associated with time proportional control at Output 2; 4) Control Type and Cycle Time setting in Out 2 is disregarded by Analog Proportional output.

OPERATION: *CONFIGURATION MODE***Set Points (if ID Number Disabled - default)**

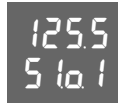
Display	Action	Response
	Press MENU (1 time) Press MAX Press MIN Press ENTER	<p>With ID number disabled and in Run Mode, pressing MENU one time advances the controller to Setpoint 1 setting directly.</p> <p>SET POINT 1</p> <ol style="list-style-type: none"> 1) Press MENU once from Run Mode. 2) Display flashes the first digit of Setpoint 1. 3) Press MAX to set the digit, 0-9. 4) Press MIN to activate the next digit (flashing). 5) Repeat step 3 and 4 until all digits are set. 6) Controller stores new setting and returns to Run Mode.
	Press MENU (2 times)	<p>SET POINT 2</p> <ol style="list-style-type: none"> 1) Press MENU twice from Run Mode. 2) Display flashes the first digit of Setpoint 2. 3) Follow step 3 to 6 of Setpoint 1 to complete the setting.
	Press MENU (3 times) Press MAX Press ENTER	<p>OUTPUT REDIRECTION</p> <ol style="list-style-type: none"> 1) Press MENU 3 times from Run Mode. 2) Display flashes “5 to 1” in the SV window. (See previous page for more details.) 3) Press MAX to select the output option. 4) Press ENTER to make the selection or MENU to advance to “Input Type”.

OPERATION: CONFIGURATION MODE

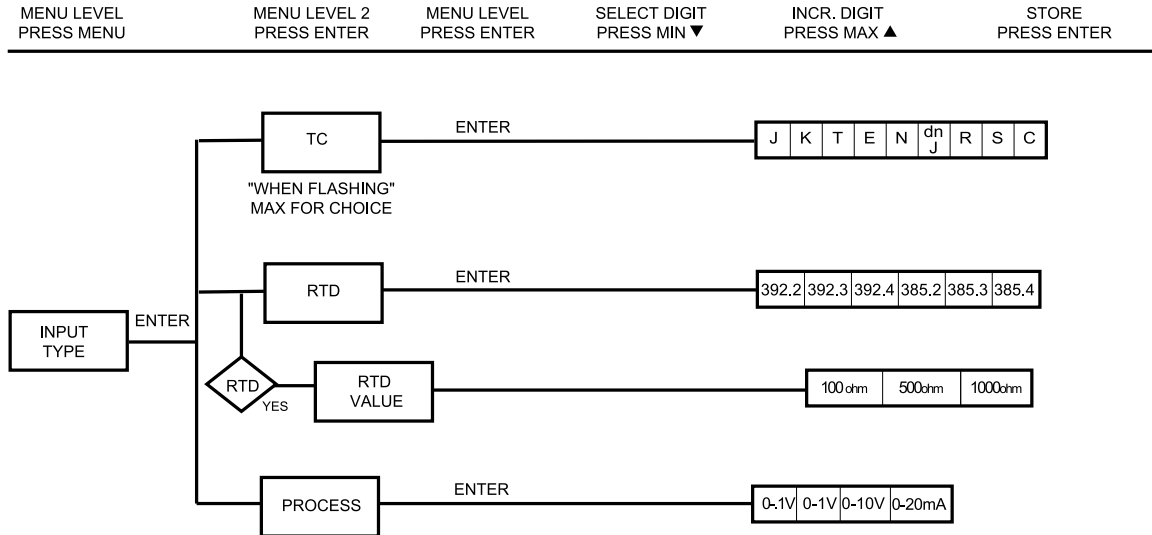

Figure 3.2 Flowchart for Input Type

Input Type (Thermocouple)



Display	Action	Response
	Press MENU Press ENTER	ENTER INPUT TYPE MENU: 1) Press MENU, if necessary, until " InPt tYPE " prompt appears. 2) Display flashes " rtD ", " tC ", or " Proc " (RTD, Thermocouple, Process), if the displayed input type is tC , press MENU to skip to step 5 (tC stops flashing).
	Press MAX Press ENTER Press ENTER	THERMOCOUPLE SUBMENU: 3) Press MAX to scroll to " tC " (flashing). 4) Display flashes "stored" message and " tC " stops flashing. 5) Display flashes previous thermocouple type selection. ie. " J " (see below for types).
	Press MAX Press ENTER	6) Scroll through the available thermocouple types to the selection of your choice. 7) Display flashes " Strd " message and advances to the next menu Reading Configuration.

Note ESR

Use the Input Type (Thermocouple) (RTD) or (Process) and verify your Dip Switch Setting (see section 2.4) and your Electrical Installation (see section 2.5). See the following pages for (RTD) and (Process) menus.

Thermocouple Types: (J, K, T, E, N, DIN J, R, S, B, C)
Display: J C R t E n dn J r S b C

Input Type (RTD)



Display	Action	Response
	Press MENU Press ENTER	ENTER INPUT TYPE MENU: 1) Press MENU, if necessary, until " InPt tYPE " prompt appears. 2) Display flashes " rtd ", " tc ", or " Proc " (RTD, Thermocouple, Process), if the displayed input type is rtd , press MENU to skip to step 5 (rtd stops flashing).
	Press MAX Press ENTER Press ENTER	RTD SUBMENU: 3) Press MAX to scroll to " rtd " (flashing). 4) Display flashes "stored" message and " rtd " stops flashing 5) Display flashes previous RTD type selection ie. 392.2. (See below for RTD types.)
	Press MAX Press ENTER	6) Scroll through the available RTD types to the selection of your choice: 7) Display flashes " Strd " message and advances to " rtd uRLU ".

RTD Types: 385, 392, Two, Three and Four-wire

Display: 3922 3923 3924 3852 3853 3854

Note Last digit indicates: 2, 3 or 4-wire input.

OPERATION: *CONFIGURATION MODE***Input Type (RTD Value)**



Display	Action	Response
	Press ENTER	RTD VALUE SUBMENU: 8) Press ENTER at " <i>rtd uALU</i> " prompt to enter your RTD Value. Display flashes previous RTD value selection ie. <i>100_</i> (see below for RTD value selections)
	Press MAX	9) Scroll through the available RTD Values to the selection of your choice:
	Press ENTER	10) Display flashes "stored" message and advances to "Reading Configuration".

RTD Values: All RTD's may be:
100 ohm 500 ohm 1000 ohm

Display: *100_* *500_* *1000*

OPERATION: CONFIGURATION MODE

Input Type (Process)

Display	Action	Response
	Press MENU Press ENTER	ENTER INPUT TYPE MENU: 1) Press MENU, if necessary, until " InPt TYPE " prompt appears. 2) Display flashes " rtd ", " tc ", or " Proc " (RTD, Thermocouple, Process), if the displayed input type is Process, press MENU to skip to step 5 (Proc stops flashing).
	Press MAX Press ENTER Press ENTER	PROCESS SUBMENU: 3) Press MAX to scroll to " Proc " (flashing). 4) Display flashes "stored" message and " Proc " stops flashing. 5) Display flashes previous Process type selection. ie. " 0-10 " (See below for types.)
	Press MAX Press ENTER	6) Scroll through the available Process types to the selection of your choice. 7) Display flashes "stored" message and advances to the next menu "Reading Configuration".

Note

Use the Input Type (Thermocouple) (RTD) or (Process) and verify your Dip Switch Setting (see section 2.4) and your Electrical Installation (see section 2.5). See the previous pages for (RTD) and (Process) menus.

Process Types:	100mV	1V	10V	0-20 mA
Display:	0-01	0-10	0-10	0-20
Natural Gain	100 cts/mv	10 cts/1mV	1 ct/mV	500 cts/mA
Max Display	9999 @100 mv	9999 @ 1V	9999 @ 10V	9999 @ 20 mA

Note

For 4-20 mA Input select 0-20 mA and adjust the Input Scale & Offset accordingly. To adjust 4-20 mA input. (See example under INPUT Scale & Offset.)

OPERATION: CONFIGURATION MODE

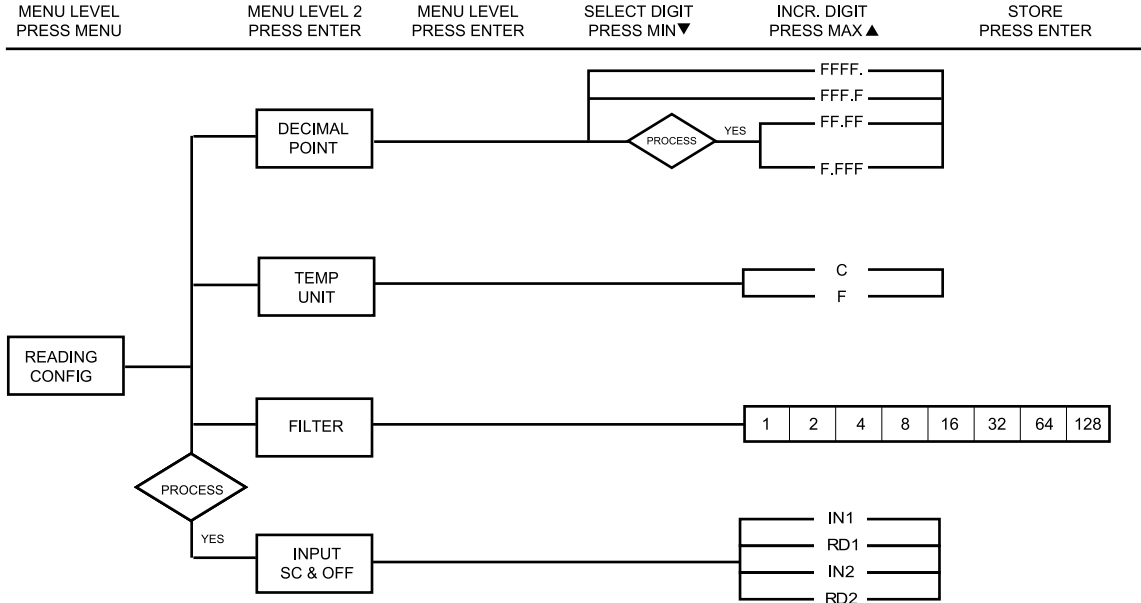







Figure 3.3 Flowchart for Reading Configuration

OPERATION: *CONFIGURATION MODE*

Reading Configuration

Display	Action	Response
	Press MENU Press ENTER	<ol style="list-style-type: none"> 1) Press MENU, if necessary, until "Reading Configuration" prompt appears. 2) Display advances to "dEC. Pt" (Decimal Point).
DECIMAL POINT SUBMENU:		
	Press ENTER	3) Display flashes previous selection for decimal location.
	Press MAX Press ENTER	<ol style="list-style-type: none"> 4) Scroll though the available selections and choose decimal location: FFFF. or FFF.F (also F.FFF and FF.FF — if "Process" type was selected in the "INPUt tYPE" menu). 5) Display flashes "Strd" message and advances to "Temperature Unit".
Note  Decimal point for Process input type is passive.		
TEMPERATURE UNIT SUBMENU:		
	Press ENTER	6) Display flashes previous Temperature Unit selection.
	Press MAX Press ENTER	<ol style="list-style-type: none"> 7) Scroll though the available selections to the temperature unit of your choice: °F or °C. 8) Display flashes "Strd" message and advances to "Filter Constant".







Reading Configuration *cont.*

Display	Action	Response
FILTER CONSTANT SUBMENU:		
	Press ENTER	9) Display flashes previous selection for filter constant.
	Press MAX	10) Scroll though the available selections: 0001, 0002, 0004, 0008, 0016, 0032, 0064, 0128. - Default is 0004
	Press ENTER	11) Display flashes "stored" message only if change was made.
		For PID control select filter value 0001-0004. A filter value of 2 is approximately equal to 1 sec. RC low pass time constant.
<p><i>If Process was selected in the "Input Type" menu the display will advance to "Input SC & OFF", otherwise the display advances to the "Alarm 1" menu.</i></p>		

The **Filter Constant** submenu allows the user to specify the number of readings stored in the digital averaging filter.

OPERATION: CONFIGURATION MODE

Reading Configuration cont. (If process was selected)

Display	Action	Response
INPUT SCALE & OFFSET SUBMENU:		
	Press ENTER	12) Press enter at the "InPt SCDF" prompt. Display flashes 1st digit in submenu "In 1"
	Press MAX & MIN	13) Use MAX and MIN buttons to enter "In 1" value. The "In 1" value = min. input value * the natural gain. Example: 4(mA) x 500 = 2000
	Press ENTER	14) Display advances to "rd 1" submenu.
	Press MAX & MIN	15) Use MAX and MIN buttons to enter "rd 1" value. This value responds to "In 1" in terms of some meaningful engineering units
	Press ENTER	16) Display advances to "In 2" submenu. The "In 2" value = max. input value * the natural gain. Example: 20(mA) x 500 = 10000 (9999)
	Press MAX & MIN	17) Use MAX and MIN buttons to enter "In 2" value.
	Press ENTER	18) Display advances to "rd 2" submenu.
	Press MAX & MIN	19) Use MAX and MIN buttons to enter "rd 2" value.
	Press ENTER	20) Display flashes "stored" message and advances to "ALAR 1" menu.
	Note	This submenu allows the user to scale the meter when in Process Mode and the above display value is an example for 4-20 mA input (4 to 20 mA = 0000 to 0100%).

Modifying Alarm settings will not reset the controller

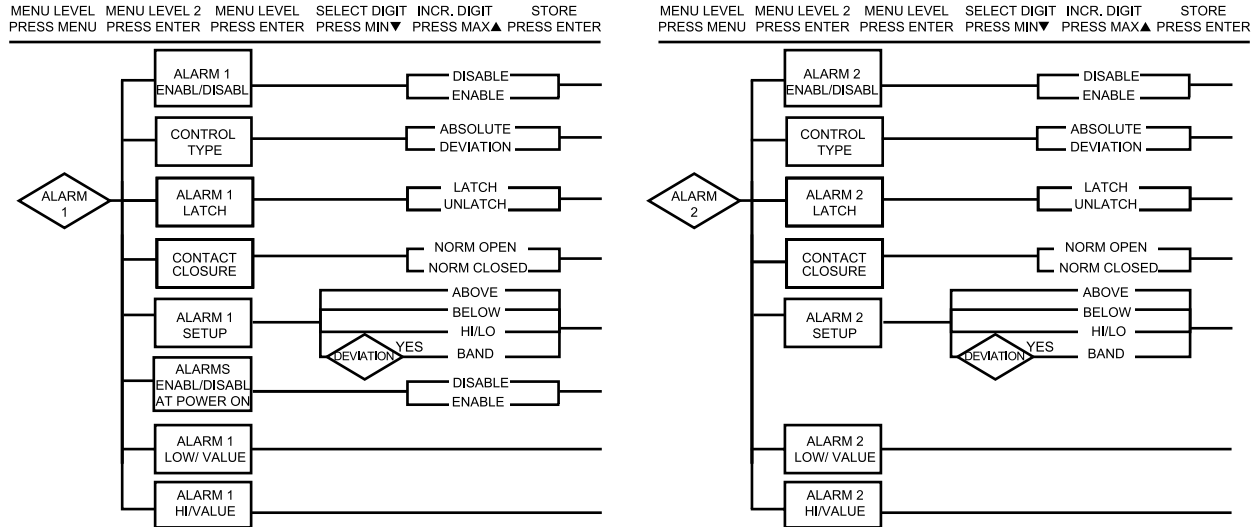





Figure 3.4 Flowchart for Alarm 1 and Alarm 2

Alarm 1



Display	Action	Response
	Press MENU Press ENTER	<ol style="list-style-type: none"> 1) Press MENU, if necessary, until "ALAr 1" prompt appears. 2) Display advances to "ALAr.1 Enbl" or "dSbl" submenu.
	Press MAX Press ENTER	<p>ALARM 1 ENABLE/DISABLE SUBMENU:</p> <ol style="list-style-type: none"> 3) Display flashes previous selection. Press MAX until "Enbl" displays to use Alarm 1. 4) Display flashes "Strd" message only if it was changed, otherwise press MENU to advance to "Control Type" submenu.
	Press MAX Press ENTER	<p>CONTROL TYPE SUBMENU:</p> <ol style="list-style-type: none"> 5) Display flashes previous selection. Press MAX to "Abs0" or "dEu" 6) Display flashes "Strd" message only if it was changed, otherwise press MENU to advance to "Alarm 1 Latch" submenu.

Note ⓘ

Absolute Mode allows Alarm 1 to function independently from Setpoint 1. If the process being monitored does not change often, then "Absolute" Mode is recommended.

Deviation Mode allows changes to Setpoint 1 to be made automatically to Alarm 1. Deviation Mode is typically the ideal mode if the process temperature changes often. In Deviation Mode, set Alarm 1 a certain number of degrees or counts away from Setpoint 1 — this relation remains fixed even if Setpoint 1 is changed.

OPERATION: *CONFIGURATION MODE***Alarm 1 cont.**

Display	Action	Response
	Press MAX Press ENTER	ALARM LATCHED OR UNLATCHED SUBMENU: 7) Display flashes previous selection. Press MAX to Latched or Unlatched . 8) Display flashes " Strd " message and advances to "Contact Closure" submenu.
	Press MAX Press ENTER	CONTACT CLOSURE SUBMENU: 9) Display flashes previous selection. Press MAX to Normally Closed (nc) or Normally Open (no) . 10) Display flashes " Strd " message only if it was changed, otherwise press MENU to advance to "Alarm 1 Setup" submenu.
	Press MAX Press ENTER	ALARM 1 SETUP SUBMENU: 13) Display flashes previous selection. Press MAX to scroll through the available selections: Above , Below , Hi/Low and Band (Band is active if "Deviation" was selected). 14) Display flashes " Strd " message only if it was changed, otherwise press MENU to advance to "Alarm 1 Low Value" submenu.

Above: Alarm 1 condition triggered when the process variable is greater than the Alarm **Hi Value**. (Lo value ignored)

Below: Alarm 1 condition triggered when the process variable is less than the Alarm **Low Value**. (Hi value ignored)



Hi/Low: Alarm 1 condition triggered when the process variable is less than the Alarm **Low Value** or above the **Hi Value**.

Band: Alarm 1 condition triggered when the process variable is above or below the "Band" set around Setpoint 1. Band equals **Hi Value** (Lo Value ignored). A "Band" is set around the Setpoint 1 by the controller only in the "Deviation" Mode.

Alarm 1 cont.

Display	Action	Response
	Press MAX	<p>ALARMS ENABLE/DISABLE AT POWER ON:</p> <p>11) Display flashes previous selection. Press MAX to enable or disable.</p> <p>Note <small>ESP</small> If the alarm is enabled at Power On, the alarm will be active right after reset. If the alarm is disabled at Power On, the alarm will become enabled when the process value enters the non alarm area. The alarm is not active while the Process value is approaching Setpoint 1.</p>
	Press ENTER	12) Display flashes "Stored" message only if it was changed, otherwise press MENU to advance to the "Alarm 1 Low Value" submenu.
	Press MAX & MIN	<p>ALARM 1 LOW VALUE SUBMENU:</p> <p>15) Display flashes 1st digit of previous value. Use MAX and MIN to enter new value.</p>
	Press ENTER	16) Display flashes " Strd " message, only if it was changed, otherwise press MENU to advance to "Alarm 1 HI Value" submenu.
	Press MAX & MIN	<p>ALARM 1 HI VALUE SUBMENU:</p> <p>17) Display flashes 1st digit of previous value. Use MAX and MIN to enter new value.</p>
	Press ENTER	18) Display flashes " Strd " message only if it was changed, otherwise press MENU to advances to "Alarm 2" submenu.
Note <small>ESP</small>	<p>Latched Mode: Relay remains "latched" until reset. To reset a latched alarm, put unit into "Stand-by" Mode by pressing the ENTER button twice. Then, enter back into Run Mode by pressing the ENTER button a third time and alarm will be de-energized.</p> <p>Unlatched Mode: Relay remains latched only as long as the alarm condition is true.</p> <p>Normally Closed: "Fail Safe" Mode, relay is energized under "normal" conditions and becomes de-energized during alarm or power failure.</p> <p>Normally Open: If this feature is selected, then the relay is "energized" only when an alarm condition occurs.</p>	

Alarm 2

Display	Action	Response
	Press MENU Press ENTER	<ol style="list-style-type: none">1) Press MENU, if necessary, until "ALAr 2" display appears.2) Display advances to "Alarm 2 Enable/Disable" submenu.
	Press MENU	IF ALARM 2 IS NOT INSTALLED, THE CONTROLLER WILL SHOW "NOT INSTALLED" Press MENU, if you receive the "not installed" message and advance to the "Loop Break" menu.
	Press MAX Press ENTER	ALARM 2 ENABLE/DISABLE SUBMENU: <ol style="list-style-type: none">3) Display flashes previous selection. Press MAX until "Enbl" displays to use Alarm 2.4) Display flashes "Strd" message only if it was changed, otherwise press MENU to advance to "Control Type" submenu.

Note

The remaining Alarm 2 is identical to Alarm 1 i.e. previous two pages.

OPERATION: *CONFIGURATION MODE*

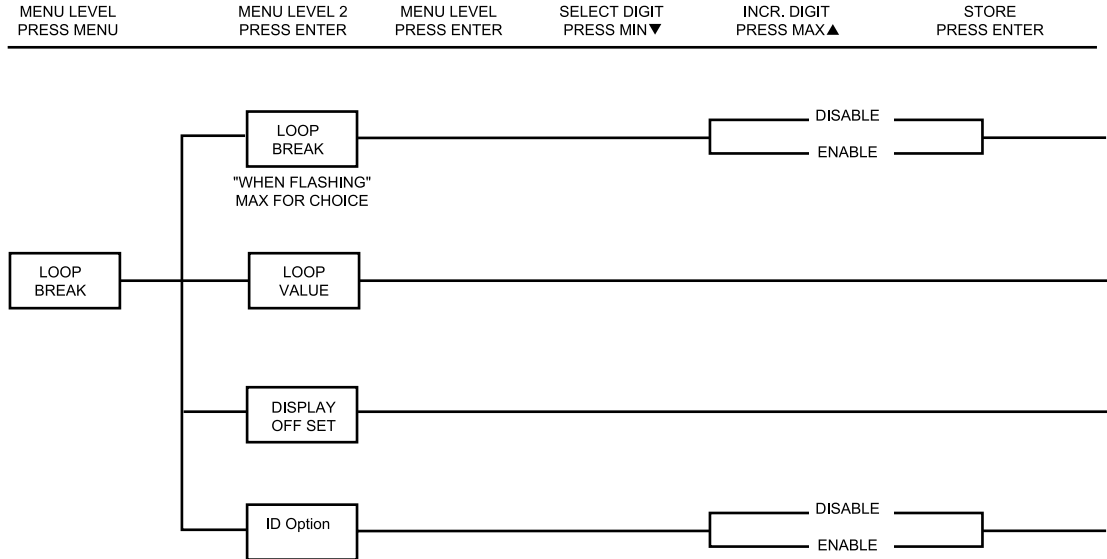



Figure 3.5 Flowchart for Loop Break



OPERATION: *CONFIGURATION MODE***Loop Break Alarm**

Display	Action	Response
	Press MENU Press ENTER	<ol style="list-style-type: none"> 1) Press MENU, if necessary, until the "Loop Break" prompt appears. 2) Display advances to "Loop Break Enable/Disable" submenu.
	Press ENTER Press MAX Press ENTER	<p>LOOP BREAK ENABLE/DISABLE SUBMENU:</p> <ol style="list-style-type: none"> 3) Display flashes "EnbL" or "d5bL". 4) Scroll through the available selections: Enable (EnbL) or Disable (d5bL). 5) Display flashes "Strd" message and advances to "Loop Value" menu.

Note

Loop Break is an additional safety feature intended to monitor the rate of change of the process value, while approaching the SPI. It is strictly intended as an additional warning system, therefore its use is entirely optional. An active Loop Break will cause the setpoint digits to blink in a rotating pattern. If the process value reaches the setpoint the blinking will stop and **LOOP brAL** is completed successfully, otherwise **LOOP brAL** will flash and will activate **ALr l**.

Loop Break Alarm cont.

Display	Action	Response
	Press ENTER Press MAX & MIN Press ENTER	LOOP BREAK ALARM VALUE SUBMENU: 6) Display flashes 1st digit of previous loop value. 7) Press MAX and MIN buttons to enter a new "Loop Value". 8) Display flashes " Strd " message and advances to "CJ Temperature Adjust" Menu.
	Press ENTER Press MAX & MIN Press ENTER	TEMPERATURE ADJUST SUBMENU: 9) Display flashes 1st digit of previous temperature adjust value. 10) Press MAX and MIN buttons to enter a new "Temperature Adjust" value. 11) Display flashes " Strd " message and advances to "ID Option" submenu.

Note

Loop Break Alarm Value allows the user to determine the time interval in MM:SS (from zero to 99 minutes and 59 seconds) that the process value changes 10 counts or if the input type is either RTD or Thermocouple, the value would be 4°Fahrenheit or 2°Celsius. At the specified time interval, if the process value change is less than the stated rate flashing, "**LbAL**" will be displayed, the output "**I**" will be de-energized, and Alarm 1 energized. Loop Break Alarm will be disabled when the process value (PV) enters the control band.

Tip

Display Offset Adjust allows the user to fine tune a minor error of the transducer, however some applications may require a large offset adjust. (Displayed Process Value = Measured Process Value ± **tAdj**). **tAdj** is adjustable between -1999 to 9999.

OPERATION: *CONFIGURATION MODE***Loop Break Alarm cont.****Display****Action****Response**

 A screenshot of a digital display showing the text 'id' on the top line and 'd5bl' on the bottom line.

Press MAX
Press ENTER

ID CODE OPTION SUBMENU

- 12) Display flashes current status of ID Option, enabled or disabled.
- 13) Press MAX button to select between **Enable** and **Disable**.
- 14) Display flashes "**5trd**" and advances to "Output 1."

Note

With ID Code Option disabled, the ID Number submenu is hidden. Refer to the appropriate setpoints section for setting differences.

OPERATION: CONFIGURATION MODE

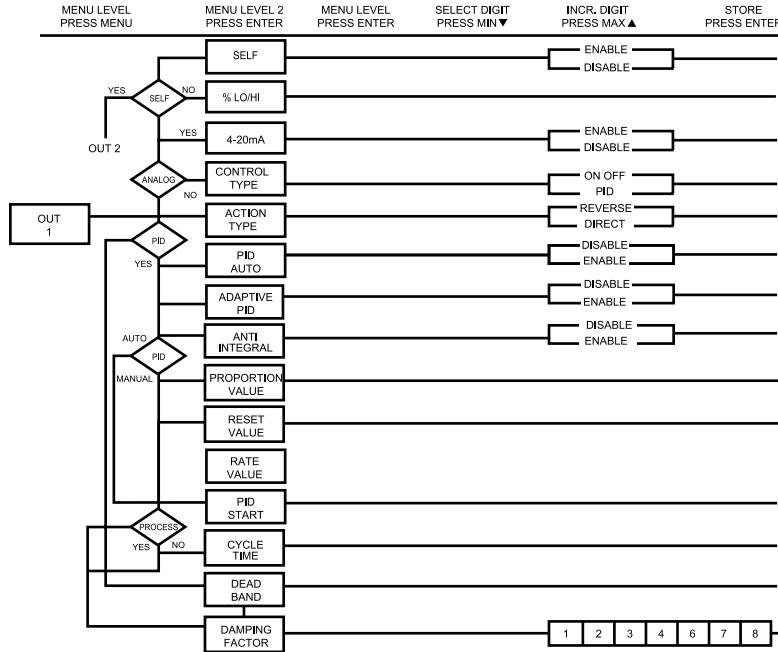









Figure 3.6 Flowchart for Output 1

Output 1

Display	Action	Response
	Press MENU Press ENTER	<ol style="list-style-type: none"> 1) Press MENU, if necessary, until the "out 1" prompt appears. 2) Display advances to "Self" submenu.
	Press MAX Press ENTER	<p>SELF SUBMENU</p> <p>The Self Option allows the output of the controller to be controlled manually from the front panel.</p> <ol style="list-style-type: none"> 3) Display flashes the current setting of Self, enabled or disabled. 4) Press the MAX button to select between Enable and Disable. 5) If Self enable was selected, Output 1 setting is completed and the display advances to the next menu.
		<p>The output is now under the direct control of the operator and can be adjusted in the run mode, by pressing the MAX and MIN buttons. The control value (0 - 99), now displayed in the SV window indicate, approximately in percent, the output. For example, a setting of 0050 of an analog output of 0~10 Vdc would produce roughly 5 Vdc at the output. Also, to insure smooth transition when switching to self mode, the proportional control output is left in its last value, when Self Mode is activated for the first time.</p>
		<ol style="list-style-type: none"> 6) Display advances to the "Minimum/Percent Low" submenu, if Self is disabled.
		<p>MINIMUM/PERCENT LOW SUBMENU</p> <p>Specify in percent, the minimum value (0000) for control output. If the output is analog, then the minimum voltage or current, in percent, is specified. If the output is time proportional, then the minimum duty-cycle, in percent, is specified.</p>
	Press MIN & MAX Press ENTER	<ol style="list-style-type: none"> 7) Display shows "0%LO", and flashes the 10s digit of the current "Percent Low" setting. 8) Use MAX & MIN buttons to enter a new value for "Percent Low". 9) Press ENTER to store the current setting and to advance to Maximum/Percent High.

Output 1 cont.

Display	Action	Response
	Press MIN & MAX Press ENTER	<p>MAXIMUM/PERCENT HIGH SUBMENU Specify in percent, the maximum value (0099) for control output. If the output is analog, then the maximum voltage or current, in percent, is specified. If the output is time proportional, then the maximum duty-cycle, in percent, is specified.</p> <p>10) Display shows "0HI" and flashes the 10s digit of the current Percent Low setting. 11) Use MAX & MIN buttons to enter a new value for Percent Low. 12) Press ENTER to store the current setting and to advance to *Control Type submenu.</p>
<p>Example: On an analog output of 0~10 Vdc, a setting of %LO = 10 and %HI = 90, cause the minimum on the control output to be 1 V and the maximum on the control output to be 9 V. The same setting on a time proportional output, will cause 10% duty cycle for the minimum control output and 90% duty cycle for the maximum control output. To disable %LO/HI, set LO to 00 and HI to 99. If %LO/HI is at other values than the default (%LO = 00, %HI = 99), "Soak" is disabled.</p>		
	Press ENTER Press MAX	<p>*CONTROL TYPE SUBMENU: (<i>Relay, SSR or Pulse Option</i>)</p> <p>13) Display flashes "On/Off" or "PID". 14) Scroll through the available selections: ON/OFF or PID.</p>
	Press ENTER	15) Display flashes "Strd" message and advances to "Action Type" submenu.
	<p>The ON/OFF control is a coarse way of controlling the process. The "Dead Band" improves the cycling associated with the On/Off control. The PID control is best for processes where the setpoint is continuously changing and/or a tight control of the process variable is required. PID control requires tuning and adjustment of the "Proportional", "Integral or Reset" and "Derivative or Rate" terms by a trial-and-error method. The Controller provides an "Auto Tuning" feature making the tuning process automatic, possibly optimum.</p>	

OPERATION: CONFIGURATION MODE

Output 1 cont.

Display	Action	Response
---------	--------	----------



*If Current/Voltage is your analog control output 1, this menu i.e. **ctrl** type will not appear, instead 4-20/Curr will be displayed. Select "**Enbl**" for a 4-20 mA (2-10 V) output or "**dSbl**" for a 0-20 mA (0-10 V) output. If 4-20 mA is enabled, %HI/LO setting will have no effect.

Note U38

Both Current and Voltage control outputs are active simultaneously.



Press ENTER

ACTION TYPE SUBMENU:

16) Display flashes "**drct**" or "**rvrs**".

Press MAX

17) Scroll through the available selections: **Direct** or **Reverse**.

Press ENTER

18) Display flashes "**Strd**" message and advances to "Auto PID" submenu.







If "**ON/OFF**" was selected in the Control Type, the display skips to the "**Dead Band**" submenu.





Note U38

The error that results from the measurement of the process variable may be positive or negative since it may be greater or smaller than the set point. If a positive error should cause the controller output to increase (i.e. cooling), it would be called **Direct Acting**. If a negative error should cause the output to increase (i.e. heating), it would be called **Reverse Acting**.

OPERATION: *CONFIGURATION MODE***Output 1 cont.**

Display	Action	Response
	Press ENTER Press MAX	AUTO PID SUBMENU: 19) Display flashes " EnbL " or " d5bL ". 20) Scroll through the available selections: Enable or Disable.
		If " Enabled ", the controller can determine, by enabling Start PID, the optimum values for the three adjustments — Proportional, Reset and Rate corresponding to P, I, and D. These values may be changed once the auto tuning is complete. If " Disabled " is selected, the user will manually enter these three adjustment values. If you want the controller to do the auto P Id and the P, P I or P Id , first select auto disable and enter 0000 for the unwanted parameter. e.g. for P I enter 0000 for the rate.
	Press ENTER	21) Display flashes "stored" message and advances to "Adaptive Control" submenu.
	Press ENTER Press MAX	*ADAPTIVE CONTROL SUBMENU: * (NOT INSTALLED) 22) Display flashes " EnbL " or " d5bL ". 23) Scroll through the available selections: Enable or Disable .
		If " Enabled ", the Adaptive Tuning dynamically changes and updates the P, I, and D parameters for optimum control. The adaptive tuning is useful when the load continuously changes thereby requiring new values for P, I, and d .
	Press ENTER	24) Display flashes "stored" message and advances to "Anti Integral" submenu.



Output 1 cont.

Display	Action	Response
	Press ENTER Press MAX	ANTI INTEGRAL SUBMENU: 25) Display flashes "Enbl" or "d5bl". 26) Scroll through the available selections: Enable or Disable .
	Press ENTER	If " Enabled ", this feature allows the error term outside the proportional band to be calculated and accumulated for integration. This may be an important feature in applications where fast response time is desirable. 27) Display flashes "stored" message and advances to "Proportional Band" submenu if Auto PID was disabled, otherwise it will go to " Start PID ".
	Press ENTER Press MAX	START AUTO TUNE PID: 28) Display flashes "Enbl" or "d5bl". 29) Scroll through the available selections: Enable or Disable .
	Press ENTER	If " Enabled ", the controller is ready to calculate P, PI or PID parameters. The setpoints must be at least 20°F or 11°C above the (PV) Process Value in order to perform autotune, otherwise an error message will be displayed. 30) Display flashes " Strd " message and advances to the "Cycle Time" submenu.



Note

To start Auto Tune PID select PID, enable Auto PID and enable Start PID. Sometimes Auto PID parameter needs fine tuning i.e. for each 5°F over shoot increase the Proportional Band (PB) by 15% and for each ±1°F fluctuation at the Setpoint (SP) increase reset by 20%. **Once started, display shows "ALU" with the letters blinking in the rotating pattern. Do not perform any operations or settings before first stopping Auto Tune. Any alarms or other output is disabled during Auto Tune.**

OPERATION: *CONFIGURATION MODE***Output 1 cont.**

Display	Action	Response
	Press ENTER Press MAX & MIN Press ENTER	<p>If "AUTO TUNE PID" was "DISABLED", the display will show the following three submenus so the user may manually enter values for Proportional, Reset and Rate terms corresponding to P, I, and D. It also can be used for auto PID for disabling unwanted parameters e. g. PI, enter 0000 for rate:</p> <p>PROPORTIONAL BAND SUBMENU:</p> <p>28) Display flashes 1st digit of the previous P "Proportional Band" value. 29) Press MAX and MIN buttons to enter a new "Proportional Band" value. 30) Display flashes "Strd" message and advances to "Reset Setup" submenu. NOTE: Proportional band is in degrees of temperature or counts of process.</p>
	Press ENTER Press MAX & MIN Press ENTER	<p>RESET SETUP SUBMENU:</p> <p>31) Display flashes 1st digit of the previous I "Reset" value. 32) Press MAX and MIN buttons to enter a new "Reset" value. 33) Display flashes "Strd" message and advances to "Rate Setup" menu. NOTE: Reset unit is in seconds 0-3999.</p>
	Press ENTER Press MAX & MIN Press ENTER	<p>RATE SETUP SUBMENU:</p> <p>34) Display flashes 1st digit of previous D "Rate" value. 35) Press MAX and MIN buttons to enter a new "Rate" value. 36) Display flashes "Strd" message and advances to the "Cycle Time" submenu for RTD and Thermocouple types. If the Output 1 is analog option the display skips to "Damping Factor". NOTE: Rate unit is in seconds 000.0-399.9.</p>



OPERATION: *CONFIGURATION MODE***Output 1 cont.**

Display	Action	Response
	Press ENTER	CYCLE TIME SUBMENU: 37) Display flashes 1st digit of the previous "Cycle Time" value.
	Press MAX & MIN	38) Press MAX and MIN buttons to enter a new "Cycle Time" value. (1 to 199 seconds).
	Press ENTER	39) Display flashes "stored" message and advances to "Damping Factor" submenu.

Note

A Cycle Time selected between 1 and 199 seconds determines the total On/Off time of each proportional cycle. For example, a 15 second Cycle Time means that every 15 seconds the output will turn on for part or all of the cycle. For Relay control outputs, do not select a cycle time of less than 7 seconds or the relays life time will be shortened. For a Cycle Time of less than 7 seconds select SSR or DC pulse. Use an external SSR with the DC pulse option for higher currents (higher than 1 Amp).



Output 1 cont.

Display	Action	Response
	Press ENTER	DAMPING FACTOR SUBMENU: 40) Display flashes the previous "Damping Factor" selection.
	Press MAX	41) Scroll through the available selections: 0000, 0001, 0002, 0003, 0004, 0005, 0006, 0007, 0008 - Default is 0003.
	Press ENTER	42) Display flashes " Strd " message and advances to the "Output 2" menu.

Note

Damping Factor is a measure of speed, overshoot, and undershoot in which the process variable responds to the output changes of the controller, which were used during the Auto Tune. This value is typically set to the ratio of Rate to Reset. This Default value is (0003). For fast response time, this value should be decreased while for slow response time it should be increased.

OPERATION: *CONFIGURATION MODE***Output 1 cont.**

Display	Action	Response
		The "Dead Band" submenu will only appear if the "On/Off" was selected from the "Control Type" menu.
	Press ENTER	DEADBAND SUBMENU: 43) Display flashes 1st digit of the previous "Dead Band" value.
	Press MAX & MIN Press ENTER	44) Press MAX and MIN buttons to enter a new "Dead Band" value 45) Display flashes " Strd " message and advances to the "Output 2" menu.
		Note  Dead Band units are the degree of temperature or counts of process.

Note 

The Dead Band or neutral zone is the number of degrees or counts (if input type is process) around the setpoint which the process variable must pass above or below the setpoint, before the output changes state.

OPERATION: CONFIGURATION MODE

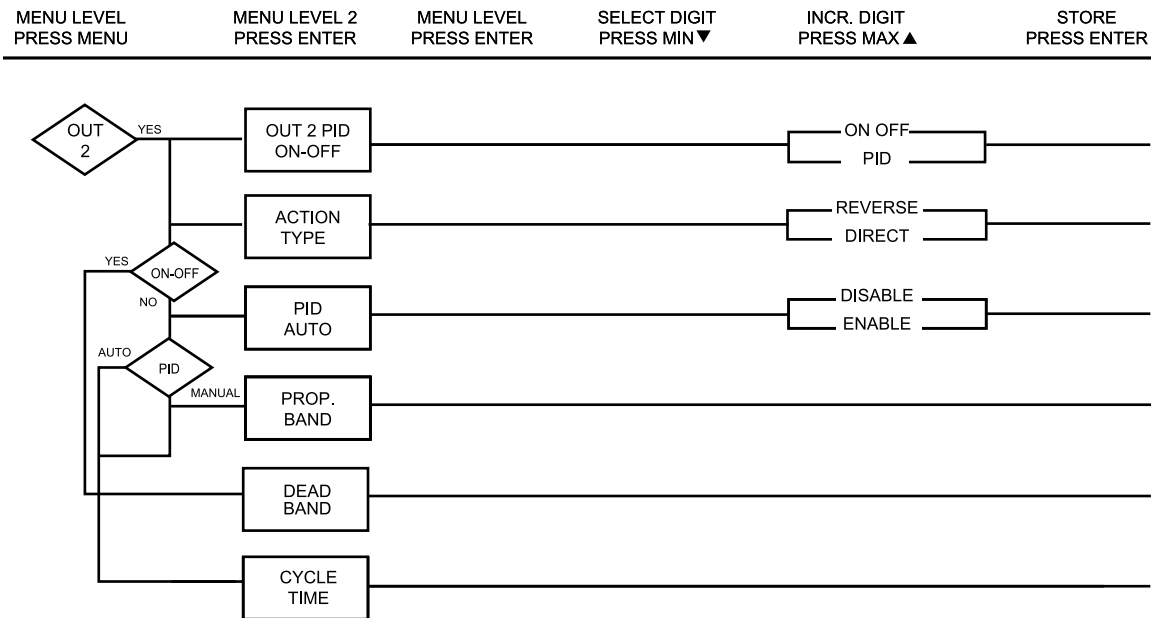





Figure 3.7 Flowchart for Output 2



OPERATION: *CONFIGURATION MODE***Output 2**

Display	Action	Response
	Press MENU Press ENTER	<ol style="list-style-type: none"> 1) Press MENU, if necessary, until the "out 2" prompt appears. 2) Display advances to "Control Type" submenu.
	Press MENU	<p>IF OUTPUT 2 IS NOT INSTALLED, THE CONTROLLER WILL SHOW "NOT INSTALLED"</p> Press MENU, if the "not installed" message is displayed, advance to the "Ramp & Soak" submenu.
	Press ENTER Press MAX	<p>CONTROL TYPE SUBMENU:</p> <ol style="list-style-type: none"> 3) Display flashes "On.OFF" or "P Id". 4) Scroll through the available selections: On.OFF or P Id.
	Press ENTER	<ol style="list-style-type: none"> 5) Display flashes "Strd" message and advances to "Action Type" submenu.

Note

The **ON/OFF** control is a coarse way of controlling the process. The "Dead Band" improves the cycling associated with the On/Off control. The **PID** control is best for processes where the set point is continuously changing and/or tight control of the process variable is required.





Output 2 cont.

Display	Action	Response
	Press ENTER	ACTION TYPE SUBMENU: 6) Display flashes " drct " or " rUr5 ".
	Press MAX Press ENTER	7) Scroll through the available selections: Direct or Reverse . 8) Display flashes " Strd " message and advances to "Auto PID" submenu.
		If " ON/OFF " was selected in the Control Type, the display skips to the " Deadband " submenu.



Note

The error that results from the measurement of the process variable may be positive or negative since it may be greater or smaller than the set point. If a positive error should cause the controller output to increase (i.e. cooling), it would be called **Direct Acting**. If a negative error should cause the output to increase (i.e. heating), it would be called **Reverse Acting**.

Output 2 cont.

Display	Action	Response
	Press ENTER Press MAX	AUTO PID SUBMENU: 9) Display flashes "Enbl" or "d5bl". 10) Scroll through the available selections: Enable or Disable . If "Enabled", the PID parameter of Output 1 will be copied to Output 2.
	Press ENTER	11) Display flashes "Strd" message and advances to the next submenu — If "Auto PID" was "Enabled", the display skips to the "Cycle Time" submenu. If "Auto PID" was "Disabled", the display will show the "Proportional Band" submenu allowing the user to manually enter the Proportional Band value.
		Note  The Reset and Rate value are the same as Output 1.
	Press ENTER Press MAX & MIN Press ENTER	PROPORTIONAL BAND SUBMENU: 12) Display flashes 1st digit of the previous "Proportional Band" value. 13) Press MAX and MIN buttons to enter a new "Proportional Band" value. 14) Display flashes "Strd" message and advances to the "Cycle Time" submenu.
		Note  Refer to Proportional Band, submenu of Output 1 Menu.



Output 2 cont.

Display	Action	Response
	Press ENTER	CYCLE TIME SUBMENU: 15) Display flashes 1st digit of the previous "Cycle Time" value.
	Press MAX & MIN	16) Press MAX and MIN buttons to enter a new "Cycle Time" value. (1 to 199 seconds).
	Press ENTER	17) Display flashes "stored" message and advances to "Ramp & Soak" Menu.

Note

A Cycle Time selected between 1 to 199 seconds indicates the total On/Off time of each proportional cycle. For example, a 15 second Cycle Time means that every 15 seconds the output will turn on for part or all of the cycle. For Relay control outputs, do not select a cycle time of less than 7 seconds or the relays life time will be shortened. For a cycle time of less than 7 seconds select SSR or DC pulse. Use an external SSR with the DC pulse option for higher current (higher than 1 Amp).

OPERATION: *CONFIGURATION MODE***Output 2 cont.**

Display	Action	Response
		The "Dead Band" submenu will only appear if the "On/Off" was selected from the "Control Type" menu.
	Press ENTER	DEAD BAND SUBMENU: 18) Display flashes 1st digit of the previous "Dead Band" value.
	Press MAX & MIN Press ENTER	19) Press MAX and MIN buttons to enter a new "Dead Band" value. 20) Display flashes "stored" message and advances to the "Ramp Value" menu.
		Note  Refer to Dead Band submenu of Output 1 Menu.

Note 

The Dead Band is the number of degrees or counts around the setpoint which the process variable must pass through before the output changes state.

OPERATION: *CONFIGURATION MODE*

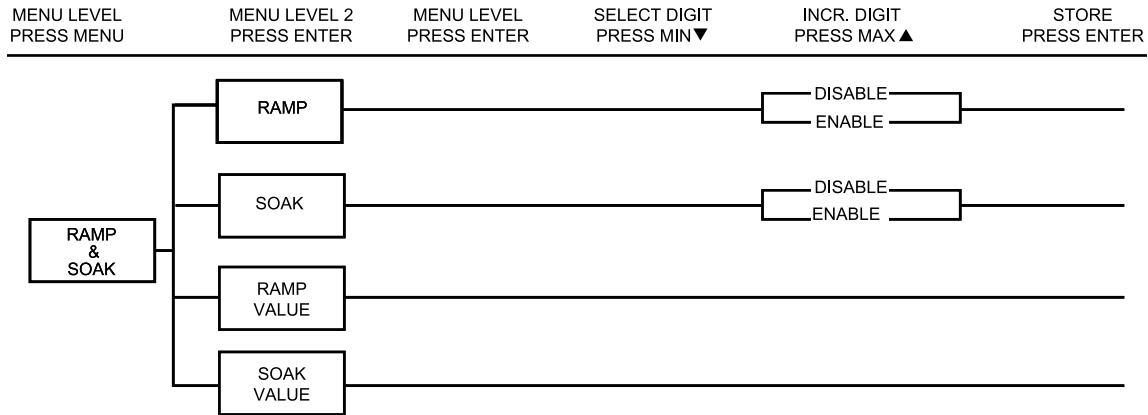





Figure 3.8 *Flowchart for Ramp & Soak*

Ramp & Soak



Display	Action	Response
	Press MENU Press ENTER	<ol style="list-style-type: none"> 1) Press MENU, if necessary, until the "rANP SoAc" prompt appears. 2) Display advances to "Ramp Enable/Disable" submenu.
	Press ENTER Press MAX Press ENTER	<p>RAMP ENABLE/DISABLE SUBMENU:</p> <ol style="list-style-type: none"> 3) Display flashes "Enbl" or "d5bl". 4) Scroll through the available selections: Enable or Disable. 5) * Display flashes "Strd" message and advances to "Soak Enable/Disable" submenu.
	Press ENTER Press MAX Press ENTER	<p>SOAK ENABLE/DISABLE SUBMENU:</p> <ol style="list-style-type: none"> 6) Display flashes "Enbl" or "d5bl". 7) Scroll through the available selections: Enable or Disable. 8) Display flashes "Strd" message and advances to "Ramp Value" submenu.

Note

Ramp & Soak provides users with the flexibility to slowly bring the process variable to the desired set point. Ramp & Soak Values are specified in HH.MM format. The Ramp Value indicates the time specified to bring the process variable to Setpoint 1. Once setpoint is reached, the PID takes over and the process variable will be controlled at the desired setpoint indefinitely. If Soak is enabled, PID will control the process variable at the specified setpoint for the duration of soak time and then will turn off Output 1. To start a new ramp/soak cycle, reset the controller by pressing MENU and then MIN button. An active ramp/soak will change SP1 one degree above the PV and will cause the most significant digit to blink. The SP1 will be incremented by one degree until it reaches the original SP1. The minimum ramp time must be at least twice the time that it will take the PV to reach the SV with OUT1 fully ON.

* **NOTE:** If "Ramp" Disable was selected, the display skips "Soak" submenu to the next menu item.

Ramp & Soak *cont.*

Display	Action	Response
	Press ENTER	RAMP VALUE SUBMENU: 9) Display flashes 1st digit of previous " <i>rANP</i> " value.
	Press MAX & MIN	10) Press MAX and MIN buttons to enter a new " <i>rANP</i> " value.
	Press ENTER	11) Display flashes " <i>Strd</i> " message and advances to "Soak Value" submenu.
	Press ENTER	SOAK VALUE SUBMENU: 9) Display flashes 1st digit of previous "Soak" value.
	Press MAX & MIN	10) Press MAX and MIN buttons to enter a new "Soak" value.
	Press ENTER	11) Display flashes " <i>Strd</i> " message and advances to the "Analog Output".

Note

The Ramp & Soak time is 00:00 to 99:59 i.e. HH.MM.(from zero to 99 hours and 59 minutes)

During Ramp & Soak do not perform any operations or settings before first pressing MENU and MIN buttons or using software disable Ramp. Any alarms or other output are disabled during this time.

3.3 Available Options

The Controller may be ordered with one of the three following options:

- 1) **Analog Output:** This option provides additional flexibility to transmit the equivalent value of process variable to other devices using a 4 to 20 mA current loop or 0-10 V signal.
- 2) **Communication Option:** This option makes the controller a very powerful instrument providing the user with even greater capability since all the parameters can be transmitted via a personal computer.
- 3) **Remote Setpoint:** One of the three already stored setpoints can be activated.

Analog Output Option

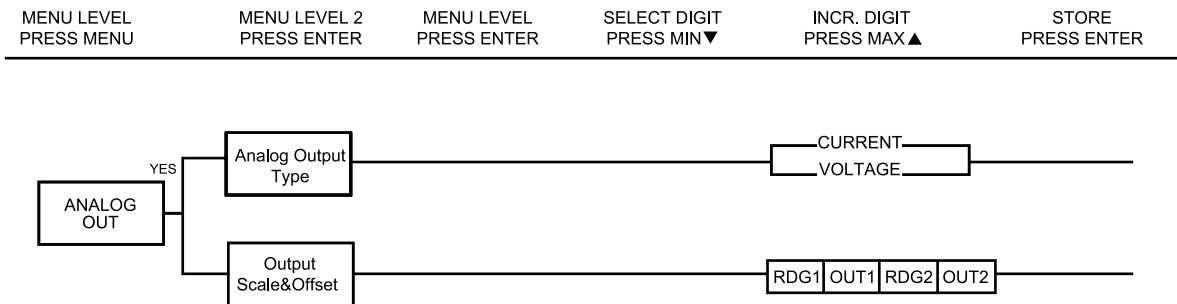









Figure 3.9 *Flowchart for Analog Output Option*

OPERATION: *CONFIGURATION MODE***Analog Output Option *cont.***

Display	Action	Response
	Press MENU Press ENTER	<ol style="list-style-type: none"> 1) Press MENU, if necessary, until the "AnLG Out" prompt appears. 2) Display advances to "Analog Type" submenu.
	Press MENU	<p>IF THE ANALOG OUTPUT OPTION IS NOT INSTALLED, THE CONTROLLER WILL SHOW "not - InSt"</p> <p>Press MENU, if you receive the "Not Installed" message and advance to the "Communication" submenu.</p>
	Press ENTER Press MAX Press ENTER	<p>ANALOG RETRANSMISSION TYPE SUBMENU:</p> <ol style="list-style-type: none"> 3) Display flashes "vOLT" or "Curr". 4) Scroll through the available selections: Volt or Current. 5) Display flashes "stored" message and advances to "Reading 1" of the Output Reading submenu.

Analog Output Option *cont.*

Display	Action	Response
	Press ENTER Press MAX & MIN Press ENTER	READING 1 6) Display flashes 1st digit of previous "Reading 1" value. 7) Enter "Reading 1" value. 8) Display advances to " out 1 ".
	Press ENTER Press MAX & MIN Press ENTER	OUT 1 9) Display flashes 1st digit of previous "Out 1" value. 10) Enter "Out 1" value. 11) Display advances to "Reading 2".
	Press ENTER Press MAX & MIN Press ENTER	READING 2 12) Display flashes 1st digit of previous "Reading 2" value. 13) Enter "Reading 2" value. 14) Display advances to " out 2 ".
	Press ENTER Press MAX & MIN Press ENTER	OUT 2 15) Display flashes 1st digit of previous "Out 2" value. 16) Enter "Out 2" value. 17) Display advances to the "Communication Option" menu.

Note The above example is for 0-10 of the entire range of the process input and analog output. For 0-20 mA output all you need is to set "Out 2" to **2000**.

Communication Option

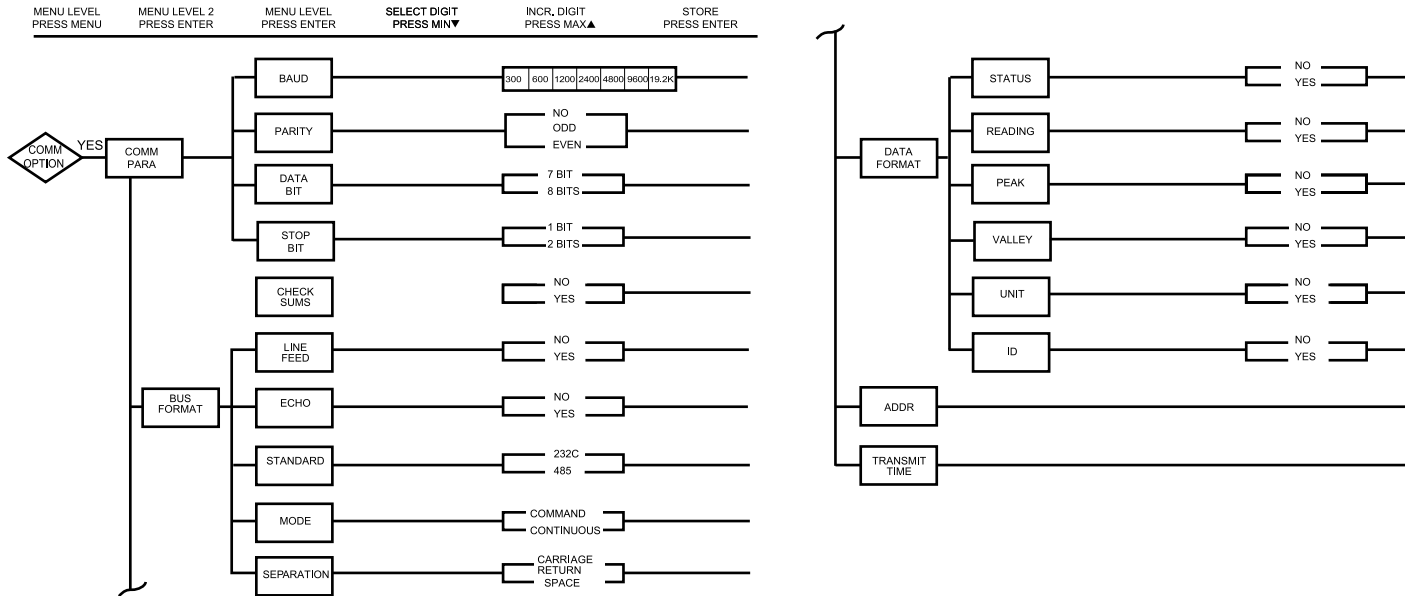
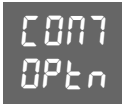









Figure 3.10 Flowchart for Communication Option





Communication Option *cont.*

Display	Action	Response
	Press MENU Press ENTER	<ol style="list-style-type: none">1) Press MENU, if necessary, until the "CON7 OPTn" prompt appears.2) Display advances to "Communication Parameters" submenu.
	Press MENU	<p>IF THE COMMUNICATION OPTION IS NOT INSTALLED, THE CONTROLLER WILL SHOW "not_Inst"</p> <p>Press MENU, if you receive the "Not Installed" message and advance to the "Remote Setpoint" menu.</p>
	Press ENTER	<p>COMMUNICATION PARAMETERS SUBMENU:</p> <p>Display shows "Communication Parameters" prompt.</p> <ol style="list-style-type: none">3) Display advances to "BAUD" submenu.
	Press ENTER Press MAX Press ENTER	<p>BAUD SUBMENU:</p> <ol style="list-style-type: none">4) Display flashes previous selection for "BAUD" value.5) Scroll through the available selections: 300, 600, 1200, 2400, 4800, 9600, 19.2K.6) Display flashes "Stnd" message and advances to "Parity" submenu.

OPERATION: *CONFIGURATION MODE***Communication Option cont.**

Display	Action	Response
	Press ENTER Press MAX Press ENTER	PARITY SUBMENU: 7) Display flashes previous selection for "Parity". 8) Scroll through the available selections: NO, ODD, EVEN . 9) Display flashes " Strd " message and advances to "Data Bit" submenu.
	Press ENTER Press MAX Press ENTER	DATA BIT SUBMENU: 7) Display flashes previous selection for "Data Bit". 8) Scroll through the available selections: 7 BIT, 8 BIT . 9) Display flashes " Strd " message and advances to "Stop Bit" submenu.
	Press ENTER Press MAX Press ENTER	STOP BIT SUBMENU: 7) Display flashes previous selection for "Stop Bit". 8) Scroll through the available selections: 1 BIT, 2 BIT . 9) Display flashes " Strd " message and advances to "BUS FORMAT" submenu.
	Press ENTER	BUS FORMAT SUBMENU: Display shows " bUS Frnt " prompt. 10) Display advances to "Check Sum" submenu.

OPERATION: *CONFIGURATION MODE***Communication Option cont.**

Display	Action	Response
	Press ENTER Press MAX Press ENTER	CHECK SUM SUBMENU: 11) Display flashes previous selection for "Check Sum". 12) Scroll through the available selections: NO, YES . 13) Display flashes " Strd " message and advances to "Line Feed" submenu.
	Press ENTER Press MAX Press ENTER	LINE FEED SUBMENU: 14) Display flashes previous selection for "Line Feed". 15) Scroll through the available selections: NO, YES . 16) Display flashes " Strd " message and advances to "ECHO" submenu.
	Press ENTER Press MAX Press ENTER	ECHO SUBMENU: 17) Display flashes previous selection for "ECHO". 18) Scroll through the available selections: NO, YES . 19) Display flashes " Strd " message and advances to "Standard" submenu.
	Press ENTER Press MAX Press ENTER	STANDARD SUBMENU: 20) Display flashes previous selection for "Standard". 21) Scroll through the available selections: 232C, 485 . 22) Display flashes " Strd " message and advances to "Mode" submenu.

Note

By setting standard to 485, the device will only respond to commands to its serial port that include the address, as selected on the following pages. (Transmit Time Section)





Communication Option *cont.*

Display	Action	Response
	Press ENTER Press MAX Press ENTER	MODE SUBMENU: 23) Display flashes previous selection for "Mode". 24) Scroll through the available selections: CMND , CONT (command, continuous). 25) Display flashes " Strd " message and advances to "Separation" submenu.
	Press ENTER Press MAX Press ENTER	SEPARATION SUBMENU: 26) Display flashes previous selection for "Separation". 27) Scroll through the available selections: SPCE , CR (space, carriage return). 28) Display flashes " Strd " message and advances to "Data Format" submenu.
	Press ENTER	DATA FORMAT SUBMENU: Display shows " dAtA Frnt " prompt. This menu is applicable for continuous mode of RS-232 communication. 32) Display advances to "Status" submenu.





Note

The Data Format options determine what readings and values will be returned in the data string sent from the unit either when operating in Continuous Mode or when receiving a Send-Data-String request via the serial port.



Communication Option *cont.*

Display	Action	Response
	Press ENTER Press MAX Press ENTER	STATUS SUBMENU: 33) Display flashes previous selection for "Status" (alarm status). 34) Scroll through the available selections: NO, YES. 35) Display flashes " Strd " message and advances to "Reading" submenu.
	Press ENTER Press MAX Press ENTER	READING SUBMENU: 36) Display flashes previous selection for "Reading". 37) Scroll through the available selections: NO, YES. 38) Display flashes " Strd " message and advances to "Peak" submenu.
	Press ENTER Press MAX Press ENTER	PEAK SUBMENU: 39) Display flashes previous selection for "Peak". 40) Scroll through the available selections: NO, YES. 41) Display flashes " Strd " message and advances to "Valley" submenu.
	Press ENTER Press MAX Press ENTER	VALLEY SUBMENU: 42) Display flashes previous selection for "Valley". 43) Scroll through the available selections: NO, YES. 44) Display flashes " Strd " message and advances to "Unit" submenu.

OPERATION: *CONFIGURATION MODE***Communication Option *cont.***

Display	Action	Response
	Press ENTER Press MAX Press ENTER	UNIT SUBMENU: 45) Display flashes previous selection for "Unit". 46) Scroll through the available selections: NO, YES. 47) Display flashes " Strd " message and advances to "ID" submenu.
	Press ENTER Press MAX Press ENTER	ID SUBMENU: NOT INSTALLED 48) Display flashes previous selection for "ID". 49) Scroll through the available selections: NO, YES. 50) Display flashes " Strd " message and advances to "Address Setup" submenu.
	Press ENTER	ADDRESS SETUP SUBMENU: . Display shows " Addr STUP " prompt. This menu is applicable to the RS-485 option only. 51) Display advances to "Address Value" (0000 to 0199) submenu.
	Press ENTER Press MAX & MIN Press ENTER	ADDRESS VALUE SUBMENU: 52) Display flashes 1st digit of previous address value. 53) Enter new address value. 54) Display flashes " Strd " message and advances to "Transmit Time" submenu. If no change press "Menu" to go on.

Communication Option *cont.*

Display	Action	Response
		TRANSMIT TIME SUBMENU: Display shows "t.r.t i StUP" prompt. This menu is applicable if Continuous Mode was selected.
	Press ENTER	55) Display advances to "Transmit Time Value" submenu.
		TRANSMIT TIME VALUE SUBMENU:
	Press ENTER	56) Display flashes 1st digit of previous transmit time in seconds.
	Press MAX & MIN	57) Enter new transmit time, e.g. 0030 will send every 30 seconds the data in Continuous Mode.
	Press ENTER	58) Display flashes "Strd" message and advances to "Remote Setpoint" menu. If no change press "Menu" to go on.

Note

Transmit time can be set from 0 to 9999.

OPERATION: *CONFIGURATION MODE***COMMUNICATION COMMANDS (Table 3.1)**

Command Prefix (Command Class)	Meaning
^AE	Special read, Communication parameters
P (Put)	Write HEX data into RAM
W (Write)	Write HEX data into EEPROM. 1,000,000 writes to EEPROM is guaranteed!
G (Get)	Read HEX data from RAM
R (Read)	Read HEX data from EEPROM
U	Read status byte
V	Read measurement data string in decimal format
X	Read measurement data values in decimal format
D	Disable
E	Enable
Z	Reset

Command Formats

For "P" and "W" Command Classes:	For "G" and "R" Command Classes:	For "X", "V", "U", "D", "E" and "Z" Command Classes:
Point-to-point mode: * ccc [<data>] <CR>	Point-to-point mode: * ccc <CR>	Point-to-point mode: * ccc <CR>
Multipoint mode: * ncccc [<data>] <CR>	Multipoint mode: * ncccc <CR>	Multipoint mode: * ncccc <CR>

Command Formats *cont.*

Where "*" is the selected Recognition Character. You may select any ASCII table symbol from "!" (HEX address "21") to the right-hand brace (HEX "7D") except for the caret "^", "A", "E", which are reserved for bus format request. "(nn)" are the two ASCII characters for the device Bus Address. Use values from "00" to hex "C7" (199 decimal).

"**ccc**" stands for the hex-ASCII Command Class letter (one of eleven given in table 3.12), followed by the two Hex-ASCII Command Suffix characters identifying the meter data, features or menu items to which the command is directed (given in table 3.13).

"**<data>**" is the string of characters containing the variable information the computer is sending to the meter. These data (whether BCD or binary) are encoded into Hex-ASCII characters, two characters to the byte. Square brackets (indicating optional status) enclose this <data> string, since some commands contain no data.

"**<nn>**" is the device address for RS-485 communication and the max is 199 in decimal.

Examples:

1. To reset the controller, send *Z02 (Table 3.1)
2. To read Setpoint 1, send *R01 (Table 3.2)
3. To change Setpoint 1 to 100.0

OPERATION: *CONFIGURATION MODE***Command Formats *cont.***

Description: SETPOINT.23 ~ 0 means 3 bytes x 8 bit positions (2 characters in each byte).

SETPOINT.23 = 0 = positive sign
1 = negative sign

SETPOINT.22~20 = 000 - Not Allowed
001 - Decimal Point 1 (XXXX.)
010 - Decimal Point 1 (XXX.X)
011 - Decimal Point 1 (XX.XX)
101 - Decimal Point 1 (X.XXX)
*Process Only

SETPOINT.19~0 = Setpoint data

For 100.0: Positive sign = 0, Decimal Point 2 = 010 Bin, Setpoint data 1000 = 3E8 Hex = 001111101000 Bin
The command data = 0010 0000 0000 0011 1110 1000 Bin = 2003E8 Hex
A 0 0 3 E 8 Hex

Send *W01 2 003E8, where

*W01 - *<ccc> - write to Setpoint 1 (Table 3.1)

2003E - <data> - Setpoint data including sign and decimal point (Table 3.2)

Command Formats *cont.*

Note ^{ESP} No spaces are allowed in the data string. The spaces provided in the previous example are for illustration purposes only.

Note ^{ESP} Decimal Point position for TC/RTD = 1 or 2, for PROCESS = 1, 2, 3, or 4.

Note ^{ESP} Decimal Point position for setpoint should be the same as Decimal Point position sets for Process Value and can not be overwritten by SETPOINT command. (See RDGCNG command, described below.)

4. To change Setpoint 1 to -100.0

For (-100.0): Negative sign = 1, Decimal Point 2 = 010 Bin, Setpoint data 1000 = 3E8 Hex = 001111101000 Bin

The command data = 1010 0000 0000 0011 1110 1000 Bin = A003E8 Hex

A 0 0 3 E 8

Send *W01A003E8

5. To send the same as above for RS-485 of transit address 01 the command is *01W01A03E8.

Note ^{ESP} Default settings are Recog. Char. “*”, 9600 bps, 7 data, 1 stop, and Odd Parity.

OPERATION: *CONFIGURATION MODE***COMMAND LETTERS AND INDEX (Table 3.2)**

Command	Command Index	Function	Command Bytes	#OF Characters	Default Value
RW	01	SP1	3	6	200000
RW	02	SP2	3	6	200000
GPRW	03	RDGOFF	3	6	200000
RW	05	ID	2	4	0000
-	06	N/A	-	-	
RW	07	INPUT	1	2	04
GPRW	08	RDGCNF	1	2	4A
RW	09	AL1CNFG	1	2	00
RW	0B	LOOP BREAK TIME	2	4	003B
RW	0C	OUT1CNF	1	2	81
RW	0D	OUT2CNF	1	2	60
RW	0E	RAMPTIME	2	4	0000
RW	10	COMM.PARAMETERS	1	2	0D
RW	12	AL1LO	3	6	A003E8
RW	13	AL1HI	3	6	201170
GPRW	14	RDGSCL	3	6	100001

OPERATION: CONFIGURATION MODE

COMMAND LETTERS AND INDEX *cont.*

Command	Command Index	Function	Command Bytes	#OF Characters	Default Value
GPRW	17	PB1/DEAD BAND	2	4	00C8
GPRW	18	RESET 1	2	4	00B4
GPRW	19	RATE 1	2	4	0000
GPRW	1A	CYCLE 1	1	2	07
-	1B	N/A	-	-	
GPRW	1C	PB2/DEAD BAND	2	4	00C8
GPRW	1D	CYCLE 2	1	2	07
RW	1E	SOAK TIME	2	4	0000
RW	1F	BUS FORMAT	1	2	14
GPRW	20	DATA FORMAT	1	2	02
RW	21	ADDRESS	1	2	01
RW	22	TRANSMIT TIME INTERVAL	2	4	0010
RW	25	C.J.OFFSET ADJ.	3	6	200000
RW	26	RECOGNITION CHARACTER	1	2	2A

COMMAND LETTERS AND INDEX *cont.*

Command	Command Index	Function
D	01	DISABLE ALARM 1
D	03	STANDBY
D	04	DISABLE SELF
E	01	ENABLE ALARM 1
E	03	DISABLE STANDBY
E	04	ENABLE SELF
X	01	SEND MAIN READING
X	02	SEND PEAK READING
X	03	SEND VALLEY READING
X	04	SEND READING
X	05	SEND READING
U	01	SEND ALARM STATUS
U	03	SEND SW VERSION
V	01	SEND DATA STRING
Z	02	HARD RESET

Note

Except for Setpoints and Alarms, modifying and setting of the menu configuration should be followed by the RESET Command.

OPERATION: *CONFIGURATION MODE***Command Formats**

Description: INPUT.76543210 means 8 bit positions of the Input Command Data (Operand).

INPUT.76 = 00 = 100 ohm RTD
 01 = 500 ohm RTD
 10 = 1000 ohm

INPUT.5432 = 0000 J/392-2/0-100 mV
 0001 K/392-3/0-1 V
 0010 T/392-4/0-10 V
 0011 E/385.2/0-20 mA
 0100 N/385.3
 0101 DIN-J/385.4
 0110 R
 0111 S
 1000 B
 1001 C

INPUT.10 = 00 TC
 01 RTD
 10 PC
 11 N/C

Example: Set RTD, 4-wire, .00392 Curve, 100 m ohms. The command data is 00001001Bin = 09Hex. Send *W0709.

Note Send Read Command first to determine the bits which are not specified for some positions (TC, PC for positions 7, 6 above).

Command Formats *cont.*

RDGCNF.210 = 000 Not Allowed

001 Decimal Point 1 (XXXX.)

010 Decimal Point 2 (XXX.X)

011 Decimal Point 3* (XX.XX)

100 Decimal Point 4* (X.XXX)

*Process only

RDGCNFG.3 = 0 °C

1 °F

RDGCNFG.765 = 000 Filter constant 1

001 Filter constant 2

010 Filter constant 4

011 Filter constant 8

100 Filter constant 16

101 Filter constant 32

110 Filter constant 64

111 Filter constant 128

Example: Set Decimal Point 1, °C, Filter constant 16. The command data is 10000001Bin = 81Hex. Send *W0881.

Note

Send a Read Command first to determine the proper Decimal Point position (*R08).

OPERATION: *CONFIGURATION MODE***Command Formats *cont.***

AL1CNFG.0 = 0 Disable
1 Enable

AL1CNFG.1 = 0 Absolute
1 Deviation

AL1CNFG.2 = 0 Unlatch
1 Latch

AL1CNFG.3 = 0 Normally Open
1 Normally Closed

AL1CNFG.54 = 00 Above
01 Below
10 Hi/Lo
* 11 Band
* Deviation Only

AL1CNFG.6 = 0 Loop Break Alarm Disable
1 Loop Break Alarm Enable

AL1CNFG.7 = 0 Alarm Power On Enable
1 Alarm Power On Disable

Example: Set Alarm 1 Enable, Deviation, Unlatch, N.C., Band, Loop Disable, Alarm Power On Enable. The command data is 10111011Bin = BBHex. Send *W09BB.

Command Formats *cont.*

Time Proportional: OUT1CNFG.0 = 0 On/off
1 PID

Analog Proportional: OUT1CNFG.6 = 0 0 - 20 mA
1 4 - 20 mA

OUT1CNFG.1 = 0 Reverse
1 Direct

OUT1CNFG.2 = 0 Auto PID Disable
1 Auto PID Enable

OUT1CNFG.3 = 0 Adaptive Disable
1 Adaptive Enable

OUT1CNFG.4 = 0 Anti Wind Up Disable
1 Anti Wind Up Enable

OUT1CNFG.5 = 0 Auto PID Stop
1 Auto PID Start

Example: Set PID, Direct, Auto PID Enable, Adaptive Enable, Anti Integral Disable, Auto PID Start. The command data is 00101111Bin = 2FHex. Send *W0C17.

OPERATION: *CONFIGURATION MODE*

Command Formats *cont.*

OUT2CNFG.0 = 0 On/off
1 PID

OUT2CNFG.1 = 0 Reverse
1 Direct

OUT2CNFG.2 = 0 Manual PID
1 Auto PID

OUT2CNFG.3 = 0 Ramp Disable
1 Ramp Enable

OUT2CNFG.4 = 0 Soak Disable
1 Soak Enable

OUT2CNFG.765 = 000 Damping 1
001 Damping 2
010 Damping 3
011 Damping 4
100 Damping 5
101 Damping 6
110 Damping 7
111 Damping 8

Example: Set On/Off, Reverse, Auto PID Disable, Ramp, Disable, Soak Disable, Damping 5. The command data is 10000000Bin = 80Hex. Send *W0D85.

Command Formats *cont.*

COMM.PARAMETERS.210 = 000	300	BAUD	COMM. PARAMETERS.43 = 00	No Parity
	001	600		01 Odd
	010	1200		10 Even
	011	2400		11 N/A
	100	4800		
	101	9600		
	110	19200		

COMM. PARAMETERS.5 = 0	7 Bit Data	COMM. PARAMETERS.6 = 0	1 Stop Bit
1	8 Bit Data	1	2 Stop Bit

Example: Set Baud 9600, Odd, 7 Bit, 1 Stop. The command data is 00001101Bin = 0DHex. Send *W100D.

BUSFORMAT.0 = N/A	BUS FORMAT.1 = 0 No LF	BUS FORMAT.2 = 0 No Echo
	1 LF	1 Echo
BUSFORMAT.3 = 0 RS-232	BUS FORMAT.4 = 0 Continuous	BUS FORMAT.5 = 0 CR
1 RS-485	1 Command	1 Space

Example: Set Space, Continuous, RS-232, Echo, Line Feed, N/A. The command data is 00000110Bin = 06Hex. Send *W1F06.

OPERATION: *CONFIGURATION MODE*

Command Formats *cont.*

Note ^{E-32} DATAFORMAT is used for V01 command or Continuous Mode (RS-232).

DATAFORMAT.0 = 0 No Status 1 Alarm Status	DATAFORMAT.1 = 0 No Reading 1 Reading	DATAFORMAT.2 = 0 No Peak 1 Peak
DATAFORMAT.3 = 0 No Valley 1 Valley	DATAFORMAT.6 = 0 No Unit 1 Unit	DATAFORMAT.7 = N/A

Example: Set Space, Continuous, RS-232, Echo, Line Feed, N/A. The command data is 00000110Bin = 06Hex. Send *W1F06.

Note ^{E-32} **ADDRESS** is applicable for RS-485 and can be 01 to 199.

Note ^{E-32} **TRANSMIT TIME INTERVAL** is applicable in the RS-232 Continuous Mode which specifies the time between transmissions and the minimum time is 1 second.

Command Formats *cont.*

RDGOFF.0~19 = Offset Data

RDGOFF.20~22 = DP+2

RDGOFF.23 = 0 Positive Offset
1 Negative Offset

RDGSC.0~18 = Scale Data

RDGSC.19 = 0 Direct Scale
1 Reverse Scale

RDGSC.20~23 = DP+1

Example: To have an input of 4 to 20 mA displayed as 0 to 100,
The Low input value = min. input value * conversion number = 4(mA) x 500 = 2000
The High input value = max. input value * conversion number = 20(mA) x 500 = 10000 (9999)
where: conversion number is a coefficient of conversion between input values and real display range.
The full range of the display = 10000, conversion number = 10000/20 = 500.

OPERATION: *CONFIGURATION MODE***Reading Scale**

Scale = (UD - LD)/(UI -LI), where: UD - Upper Display, LD - Low Display

UI - Upper Input, LI - Low Input

Scale = (100 - 0)/(9999-2000) = 0.0125016 (These values were obtained from example on previous Section 3: Reading Configuration with Process)

0.0125016 = 125016 x 10⁻⁷, where 125016 is Reading Scale Data, Decimal Point = 7

RDGSC.23~20 = 8 (DP = 7); RDGSC.19 = 0 (direct scale); RDGSC. 18 ~0 = 1E858Hex (125016 Dec)

Binary Code:

23	22	21	20	19	18	17	16	15	14	13	12	11	10	9	8	7	6	5	4	3	2	1	0
1	0	0	0	0	0	0	1	1	1	1	0	1	0	0	0	0	1	0	1	1	0	0	0

Hex. Code:

8

1

E

8

5

8

Send command: *W1481E858 (scale = 81E858)

Reading Offset

Offset = UD - Scale x UI

Offset = 100 - (0.0125) x (10000) = (-25), where Offset data = 25, Decimal Point = 0, Offset is negative.

RDGOFF.23 = 1 (Offset is negative); RDGOFF.22 ~ 20 = 2 (DP = 0); RDGOFF.19 ~ 0 = 00019Hex (25 Dec)

Binary Code:

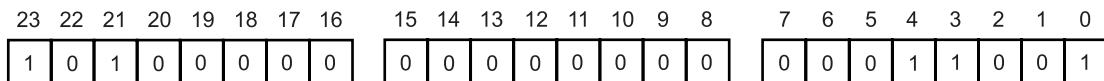

Hex. Code: **A** **0** **0** **0** **1** **9**

Send command: *W03A00019 (offset = A00019)

Note

To communicate when the Continuous Mode is enabled, the Continuous Mode must be stopped by sending 13 Hex (XOFF) and then send ^AE.

Remote Setpoint Option

MENU LEVEL
PRESS MENU

MENU LEVEL 2
PRESS ENTER

MENU LEVEL
PRESS ENTER

SELECT DIGIT
PRESS MIN▼





INCR. DIGIT
PRESS MAX▲

STORE
PRESS ENTER



Figure 3.11 *Flowchart for Remote Setpoint*

OPERATION: *CONFIGURATION MODE***Remote Setpoint Option *cont.***

Display	Action	Response
	Press MENU Press ENTER	<ol style="list-style-type: none"> 1) Press MENU, if necessary, until the "r.5Et POnt" prompt appears. 2) Display advances to "Remote Setpoint 1" submenu.
	Press MENU	<p>IF THE REMOTE SETPOINT IS NOT INSTALLED, THE CONTROLLER WILL SHOW "NOT INSTALLED".</p> <p>Press MENU, if you receive the "Not Installed" message.</p>
	Press ENTER Press MAX & MIN Press ENTER	<p>REMOTE SETPOINT 1 SUBMENU:</p> <ol style="list-style-type: none"> 3) Display flashes 1st digit of previous selection for "Remote Setpoint 1" value. 4) Enter a new "Remote Setpoint 1" value. 5) Display flashes "Strd" message and advances to "Remote Setpoint 2" submenu.
	Press ENTER Press MAX & MIN Press ENTER	<p>REMOTE SETPOINT 2 SUBMENU:</p> <ol style="list-style-type: none"> 6) Display flashes 1st digit of previous selection for "Remote Setpoint 2" value. 7) Enter a new "Remote Setpoint 2" value. 8) Display flashes "Strd" message and advances to "Remote Setpoint 3" submenu.

Remote Setpoint Option *cont.*

Display	Action	Response
	Press ENTER	REMOTE SETPOINT 3 SUBMENU: 9) Display flashes 1st digit of previous selection for "Remote Setpoint 3" value. 10) Enter a new "Remote Setpoint 3" value. 11) Display flashes " Strd " message and the display shows "Reset" ending the <i>Configuration Mode</i> .
	Press MAX & MIN	
	Press ENTER	



RESET:

The controller automatically resets after the last menu of the Configuration Mode has been entered. After the controller resets, the controller advances to the Run Mode.

Note ES3

In order to select r.SP remotely connect Bi1 and Bi2 as follows:

	Bi1	Bi2
r.SP.1	GND	GND
r.SP.2	OPEN	GND
r.SP.3	GND	OPEN
Setpoint 1	OPEN	OPEN

SPECIFICATIONS

Accuracy: See the following Specification Chart.

Resolution: 1°/0.1°; 10 μ V process

Temperature Stability: 0.08°C/°C; 50 ppm/°C process

Thermocouple Cold End Tracking: 0.05°C/°C

NMRR: 60 dB

CMRR: 120 dB

A/D Conversion: Dual slope

Reading Rate: 3 samples per second

Digital Filter: Programmable

Display: Dual 4-digit, 7-segment LED, 9.2 mm (0.36"); red process variable, green setpoint; indicators for output and alarm status; 7.6 mm (0.3") for NEMA 12 units

Warmup to Rated Accuracy: 30 min

INPUT

Input Types: Thermocouple, RTD, analog voltage, analog current

Thermocouple Lead Resistance: 100 Ω max

RTD Input: 100/500/1000 Ω Pt sensor, 2, 3, or 4-wire; 0.00385 or 0.00392 curve

Voltage Input: 0 to 100 mV, 0 to 1 V, 0 to 10 Vdc

Current Input: 0 to 20 mA (5 ohm load)

Configuration: Single-ended

Polarity: Unipolar

Step Response: 0.7 sec for 99.9%

Decimal Selection: None, 0.1, 0.01 or 0.001

Span Adjustment: 0.001 to 9999 counts

Offset Adjustment: -999 to +9999

CONTROL

Action: Reverse (heat) or direct (cool)

Modes: Time proportioning and proportional control modes; selectable preset tune, adaptive tune, auto-tune, PID, proportional, proportional with integral, proportional with derivative with anti-reset windup, on-off

Rate: 0.00 to 399.9 sec

Reset: 0 to 3999 sec

Cycle Time: 1 to 199 seconds; set to 0 for on/off operation

Gain: 0.5 to 100% of span; setpoints 1 or 2

Damping: 0.000 to 0.008

Soak: 00.00 to 99.59 (HH:MM), or off

Ramp to Setpoint: 00.00 to 99.59 (HH:MM), or off

Autotune: Operator initiated from front panel

CONTROL OUTPUT:

Relay: 5 A @ 120 Vac, 3 A @ 240 Vac; configurable for on/off, PID or ramp and soak

Output 1: SPDT type

Output 2: SPST type

SSR: Rated 0.5 A @ 120/240 Vac, continuous

DC Pulse: non-isolated; 10 Vdc @ 20 mA

Analog Output: 0 to 10 Vdc or 0 to 20 mA; 500 Ω max

OPTIONS:

Remote Setpoint Selection: Up to 3 setpoints stored in memory; contact closure selection

SPECIFICATIONS

COMMUNICATIONS:

RS-232 or RS-485: 300 to 19.2k baud; completely programmable setup capability; program to transmit current display, alarm status, min/max, actual measured input value and status

RS-485: Addressable from 0 to 199

Connection: Screw terminals

ALARM OUTPUT:

Type: SPST relay, 3 A @ 120 Vac, 3 A @ 240 Vac

Operation: High/low, latching/ non-latching, and process/deviation; front panel configurations

ANALOG OUTPUT:

Isolated 0 to 10 Vdc or 0 to 20 mA, programmable

INSULATION: (per 1 minute test)

Power to TC/RTD input: 2300 Vrms

Power to Relay/SSR Outputs: 2300 Vrms

Power to Relay Alarms: 2300 Vrms

Control Relay/SSR to Control Relay/SSR: 2300 Vrms

Relay Alarm 1 to Relay Alarm 2: 2300 Vrms

RS232/RS485/Analog to Alarms/Controls Relay/SSR/Power: 2300 Vrms

RS232/RS485 to Input TC/RTD: 350 Vrms

APPROVALS:

UL, CE per EN50081-1, EN50082-1, EN61010-1

GENERAL:

Line Voltage: 90-240 Vac +/-10%, 50-400 Hz

Power: 4 Watts

External Fuse Required: 100mA/250V Time-Slow-Blow, UL 248-14 Listed
100mA/250V Time-Lag, IEC 127-3 Listed

Environmental Condition: 0 to 55°C (32 to 131°F), 90% RH
non-condensing

ICN77300 Series: 48 H x 48 W x 123.3 mm D (1.89" x 1.89" x 4.85");

ICN77500 Series: 53 H x 53 W x 123.3 mm D (2.1" x 2.1" x 4.85");

Panel Cutout: 45 mm (1.777") square, $\frac{1}{16}$ DIN

ICN77R300 Series: 48 H x 48 W x 135 mm D (1.89" x 1.89" x 5.32");

ICN77R500 Series: 53 H x 53 W x 135 mm D (2.1" x 2.1" x 5.32");

Panel Cutout: 44.5 mm (1.75") dia round

Weight: 227 g (0.5 lb)

SPECIFICATIONS

	Input Type	Range	Accuracy*
J	Iron-Constantan	-210 to 760°C -346 to 1400°F	0.4°C 0.7°F
K	CHROMEKA®-ALOMEGA®	-270 to -160°C -160 to 1372°C -454 to -256°F -256 to 2502°F	1.0°C 0.4°C 1.8°F 0.7°F
T	Copper-Constantan	-270 to -190°C -190 to 400°C -454 to -310°F -310 to 752°F	1.0°C 0.4°C 1.8°F 0.7°F
E	CHROMEKA-Constantan	-270 to -220°C -220 to 1000°C -454 to -364°F -364 to 1832°F	1.0°C 0.4°C 1.8°F 0.7°F
R	Pt/13%Rh-Pt	-50 to 40°C 40 to 1788°C -58 to 104°F 104 to 3250°F	1.0°C 0.5°C 1.8°F 0.9°F
S	Pt/10%Rh-Pt	-50 to 100°C 100 to 1768°C -58 to 212°F 212 to 3214°F	1.0°C 0.5°C 1.8°F 0.9°F
B	30%Rh-Pt/ 6%Rh-Pt	200 to 640°C 640 to 1820°C 212 to 1184°F 1184 to 3308°F	1.0°C 0.5°C 1.8°F 0.9°F

	Input Type	Range	Accuracy*
C	5%Re-W/ 26%Re-W	0-2354°C 32-4253°F	0.4°C 0.7°F
N	Nicrosil-Nisil	-250 to -100°C -100 to 1300°C -418 to -148°F -148 to 2372°F	1.0°C 0.4°C 1.8°F 0.7°F
L	J DIN	-200 to 900°C -328 to 1652°F	0.4°C 0.7°F
RTD	Pt, 0.00385, 100Ω, 500Ω, 1000Ω	200 to 900°C -328 to 1652°F	0.4°C 0.7°F
RTD	Pt, 0.00392, 100Ω, 500Ω, 1000Ω	-200 to 850°C -328 to 1562°F	0.4°C 0.7°F
PROCESS			
	Voltage	0 to 100mV, 0 to 1V, 0 to 10Vdc	0.03% rdg 0.03% rdg
	Current	0 to 20mA, 4 to 20 mA	0.03% rdg

SPECIFICATIONS

Example of hook-up for the Solid State Relay Output for Temperature Controllers.

ac CONTROLLED SSR USED WITH TEMPERATURE CONTROLLER WITH dc VOLTAGE SSR DRIVER OUTPUT

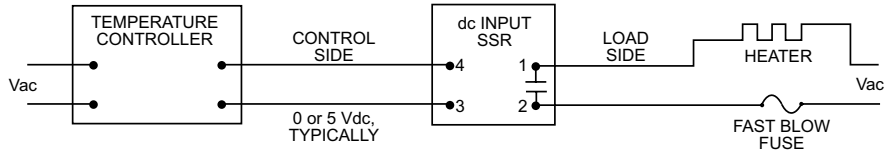

ac CONTROLLED SSR USED WITH TEMPERATURE CONTROLLER WITH MECHANICAL RELAY OUTPUT

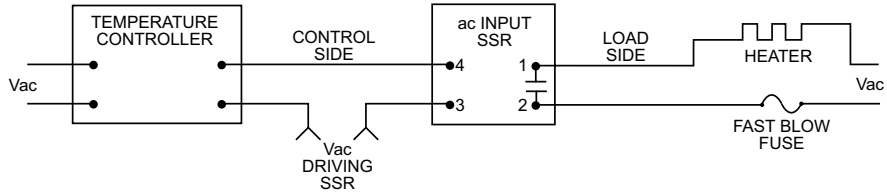

ac CONTROLLED SSR USED WITH TEMPERATURE CONTROLLER WITH TRIAC OUTPUT

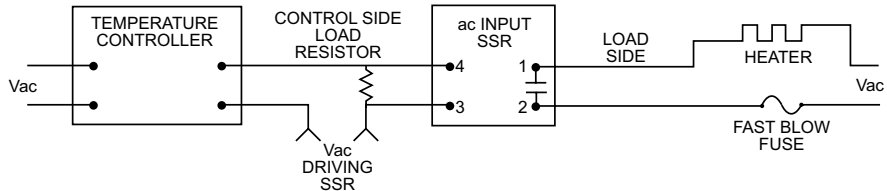

SPECIFICATIONS

1. Electromagnetic Compatibility (EMC)

This device conforms with requirements of EMC Directive 89/336/EEC, amended by 93/68/EEC. This instrument complies with the following EMC Immunity Standards as tested per EN 50082-2, 1995 (Industrial environment)

Phenomena	Test Specification	Basic Standard
Electrostatic Discharge	+/- 4 kV contact discharge +/- 8 kV air discharge	IEC 1000-4-2 Performance Criteria B
Radio Frequency electromagnetic field.	27 - 1000 MHz 10 V/m 80% AM (1 KHz)	IEC 1000-4-3 Performance Criteria A
Radio Frequency electromagnetic field. Pulse modulated.	900 MHz 10 V/m 50% Duty cycle @ 200 Hz	IEC 1000-4-3 Performance Criteria A
Fast Transients	+/- 2 kV (ac mains) +/- 1 kV (dc, signal I/O) 5/50 ns Tr/Th, 5 KHz rep. freq.	IEC 1000-4-4 Performance Criteria B
Radio Frequency conducted	0.15 - 80 MHz 10 V/m 80% AM (1 KHz)	IEC 1000-4-6 Performance Criteria A

This instrument complies with the following EMC Emission Standards as tested per EN 50081-1, 1992 (Residential, Commercial and Light Industrial)

Phenomena	Frequency Range	Limits	Basic Standard
Radiated Emission	30-230 MHz 230-1000 MHz	30 dB_V/m at 10 m 37 dB_V/m at 10 m quasi peak	CISPR 22 Class B
Conducted Emission	0.15-0.5 MHz 0.5-5 MHz 5-30 MHz	66-56 dB_V quasi peak 56 dB_V quasi peak 60 dB_V quasi peak	CISPR 22 Class B

2. Safety

This device conforms with Low Voltage Directive 73/23/EEC, amended by 93/68/EEC. The following LVD requirements have been met to comply with EN 61010-1, 1993

(Electrical equipment for measurement, control and laboratory use)

1. Pollution Degree 2
2. Installation Category II
3. Double Insulation
4. Class I Equipment (90-240 Vac Powered Units)



NOTES

NOTES

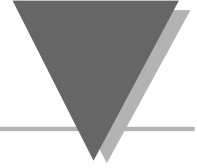



NOTES

Warranty

NEWPORT ELECTRONICS, INC. warrants this unit to be free of defects in materials and workmanship for a period of 13 months from date of purchase. NEWPORT Warranty adds an additional one (1) month grace period to the normal one (1) year product warranty to cover handling and shipping time. This ensures that NEWPORT's customers receive maximum coverage on each product..

If the unit should malfunction, it must be returned to the factory for evaluation. NEWPORT's Customer Service Department will issue an Authorized Return (AR) number immediately upon phone or written request. Upon examination by NEWPORT, if the unit is found to be defective it will be repaired or replaced at no charge. However, this WARRANTY is VOID if the unit shows evidence of having been tampered with or shows evidence of being damaged as a result of excessive corrosion; or current, heat, moisture or vibration; improper specification; misapplication; misuse or other operating conditions outside of NEWPORT's control. Components which wear or which are damaged by misuse are not warranted. These include contact points, fuses, and triacs.

In addition to our standard warranty period, NEWPORT ELECTRONICS will extend the warranty period for one (1) additional year only if the warranty card enclosed with each instrument is returned to NEWPORT.

Newport is glad to offer suggestions on the use of its various products. Nevertheless, NEWPORT warrants only that the parts manufactured by it will be as specified and free of defects. NEWPORT MAKES NO OTHER WARRANTIES OR REPRESENTATIONS OF ANY KIND WHATSOEVER, EXPRESSED OR IMPLIED, EXCEPT THAT OF TITLE, AND ALL IMPLIED WARRANTIES INCLUDING ANY WARRANTY OF MERCHANTABILITY AND FITNESS FOR A PARTICULAR PURPOSE ARE HEREBY DISCLAIMED. LIMITATION OF LIABILITY: The remedies of purchaser set forth herein are exclusive and the total liability of NEWPORT with respect to this order, whether based on contract, warranty, negligence, indemnification, strict liability or otherwise, shall not exceed the purchase price of the component upon which liability is based. In no event shall NEWPORT be liable for consequential, incidental or special damages.

Every precaution for accuracy has been taken in the preparation of this manual; however, NEWPORT neither assumes responsibility for any omissions or errors that may appear nor assumes liability for any damages that result from the use of the products in accordance with the information contained in the manual.

SPECIAL CONDITIONS: Should this equipment be used in any nuclear installation or activity, purchaser will indemnify NEWPORT and hold NEWPORT harmless from any liability or damage whatsoever arising out of the use of the equipment in such a manner.

Return Requests

Direct all warranty and repair request/inquiries to the NEWPORT Customer Service Department. BEFORE RETURNING ANY PRODUCT(S) TO NEWPORT, PURCHASER MUST OBTAIN AN AUTHORIZED RETURN (AR) NUMBER FROM NEWPORT'S CUSTOMER SERVICE DEPARTMENT (IN ORDER TO AVOID PROCESSING DELAYS). The assigned AR number should then be marked on the outside of the return package and on any correspondence.

The purchaser is responsible for shipping charges, freight, insurance and proper packaging to prevent breakage in transit. NEWPORT's warranty does not apply to defects resulting from action of the purchaser, mishandling, improper interfacing, operation outside of design limits, improper repair, or unauthorized modification.

FOR **WARRANTY** RETURNS, please have the following information available BEFORE contacting NEWPORT:

1. P.O. number under which the product was PURCHASED,
2. Model and serial number of the product under warranty, and
3. Repair instructions and/or specific problems relative to the product.

FOR **NON-WARRANTY** REPAIRS, consult NEWPORT for current repair charges. Have the following information available BEFORE contacting NEWPORT:

1. P.O. number to cover the COST of the repair,
2. Model and serial number of product, and
3. Repair instructions and/or specific problems relative to the product.

NEWPORT's policy is to make running changes, whenever an improvement is possible. This affords our customers the latest in technology and engineering.

NEWPORT is a registered trademark of NEWPORT Electronics, Inc.

© Copyright 2005 NEWPORT Electronics, Inc. All rights reserved. This documentation may not be copied, photocopied, reproduced, translated, or reduced to any electronic medium or machine-readable form, in whole or in part, without prior written consent of NEWPORT ELECTRONICS, INC.

For immediate technical or application assistance please call:

1-800-6397678®
1-800-NEWPORT

Newport Electronics, Inc.
2229 South Yale Street • Santa Ana, CA • 92704 • U.S.A.
TEL: (714) 540-4914 • FAX: (203) 968-7311
Toll Free: 1-800-639-7678
www.newportUS.com • e-mail: info@newportUS.com
ISO 9001 Certified

Newport Technologies, Inc.
976 Bergar • Laval (Quebec) • H7L 5A1 • Canada
TEL: (514) 335-3183 • FAX: (514) 856-6886
Toll Free: 1-800-639-7678
www.newport.ca • e-mail: info@newport.ca

Newport Electronics, Ltd.
One Omega Drive • River Bend Technology Centre
Northbank, Irlam • Manchester M44 5BD • United Kingdom
Tel: +44 161 777 6611 • FAX: +44 161 777 6622
Toll Free: 0800 488 488
www.newportuk.co.uk • e-mail: sales@newportuk.co.uk

NEWPORTnet™ On-Line Service www.newportUS.com

Internet e-mail info@newportUS.com
--

Newport Electronics B.V.
Postbus 8034 • 1180 LA Amstelveen • The Netherlands
TEL: +31 20 3472121 • FAX: +31 20 6434643
Toll Free: 0800 0993344
www.newport.nl • e-mail: info@newport.nl

Newport Electronics spol s.r.o.
Frystatska 184, 733 01 Karviná • Czech Republic
TEL: +420 59 6311899 • FAX: +420 59 6311114
Toll Free: 0800-1-66342
www.newport.cz • e-mail: info@newport.cz

Newport Electronics GmbH
Daimlerstrasse 26 • D-75392 Deckenpfronn • Germany
TEL: 49 7056 9398-0 • FAX: 49 7056 9398-29
Toll Free: 0800 / 6397678
www.newport.de • e-mail: sales@newport.de

Newport Electronique S.A.R.L.
11, rue Jacques Cartier • 78280 Guyancourt • France
TEL: +33 1 61 37 29 00 • FAX: +33 1 30 57 54 27
Toll Free: 0800 466 342
www.newport.fr • e-mail: sales@newport.fr

Mexico and Latin America
FAX: 001 (203) 359-7807
En Español: 001 (203) 359-7803

 **NEWPORT** Electronics, Inc.