

PLEASE CHECK WWW.MOLEX.COM FOR LATEST PART INFORMATION

Part Number: [43645-0200](#)
Status: **Active**
Overview: Micro-Fit 3.0™ Connectors
Description: Micro-Fit 3.0™ Receptacle Housing, Halogen Free, Single Row, 2 Circuits

Documents:

3D Model	Test Summary TS-43045-001 (PDF)
Drawing (PDF)	RoHS Certificate of Compliance (PDF)
Product Specification PS-43650 (PDF)	Product Literature (PDF)
Packaging Specification PK-43645-001 (PDF)	

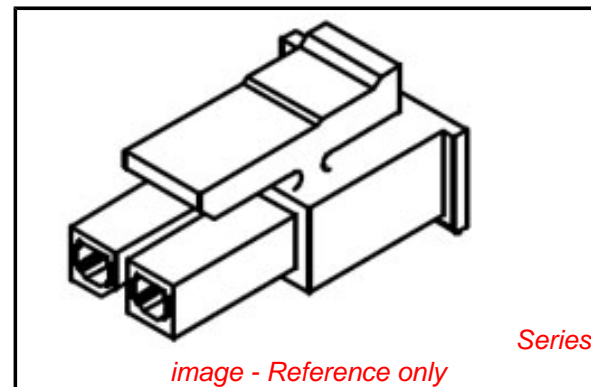

Agency Certification

CSA	LR19980
TUV	R72081037
UL	E29179

General

Product Family	Crimp Housings
Series	43645
Application	Power, Wire-to-Wire
Comments	Glow Wire Equivalent Part Number 43645-0208
MolexKits	Yes
Overview	Micro-Fit 3.0™ Connectors
Product Literature Order No	987650-5984
Product Name	Micro-Fit 3.0™
UPC	800754366168

Physical

Circuits (maximum)	2
Color - Resin	Black
Flammability	94V-0
Gender	Female
Glow-Wire Compliant	No
Keying to Mating Part	None
Lock to Mating Part	Yes
Material - Resin	Nylon
Net Weight	0.272/g
Number of Rows	1
Packaging Type	Bag
Panel Mount	No
Pitch - Mating Interface	3.00mm
Polarized to Mating Part	Yes
Stackable	No
Temperature Range - Operating	-40°C to +105°C

Electrical

Current - Maximum per Contact	5A
-------------------------------	----

Material Info

Reference - Drawing Numbers

Packaging Specification	PK-43645-001
Product Specification	PS-43650
Sales Drawing	SDA-43645-****, SDES-43645-1000
Test Summary	TS-43045-001

EU RoHS ELV and RoHS Compliant REACH SVHC Contains SVHC: No Low-Halogen Status Low-Halogen	China RoHS 
---	--

Need more information on product environmental compliance?

Email productcompliance@molex.com
 For a multiple part number RoHS Certificate of Compliance, [click here](#)

Please visit the [Contact Us](#) section for any non-product compliance questions.

Search Parts in this Series

[43645Series](#)

Mates With

[43640](#) Micro-Fit 3.0™ Plug Housings, [43650](#) Micro-Fit 3.0™ Headers

Use With

[43030](#) , [Link45773](#) Micro-Fit 3.0™ Female Crimp Terminals, [46235](#) Micro-Fit RMF™ Female Crimp Terminals

This document was generated on 12/17/2014

PLEASE CHECK WWW.MOLEX.COM FOR LATEST PART INFORMATION