

PLEASE CHECK WWW.MOLEX.COM FOR LATEST PART INFORMATION

Part Number: [19002-0005](#)
Status: **Active**
Overview: [Quick-Disconnect Terminals](#)
Description: Avikrimp™ Fully Insulated Quick Disconnect, Female, for 18-22 AWG Wire, Box

Documents:

3D Model	Product Specification PS-19902-013 (PDF)
Drawing (PDF)	Product Specification PS-19902-014 (PDF)
Product Specification PS-19902-011 (PDF)	RoHS Certificate of Compliance (PDF)

Agency Certification

CSA	LR18689
UL	E79133

General

Product Family	Quick Disconnects
Series	19002
Crimp Quality Equipment	Yes
Insulated	Fully
MolexKits	Yes
Overview	Quick-Disconnect Terminals
Product Name	Avikrimp™
Type	Quick Disconnect
UPC	800753026964

Physical

Barrel Type	Closed
Color - Resin	Red
Flammability	94V-2
Gender	Female
Glow-Wire Compliant	Yes
Insulation	Nylon (PA)
Lock to Mating Part	None
Material - Metal	Brass
Material - Plating Mating	Tin
Material - Plating Termination	Tin
Net Weight	0.846/g
Orientation	Straight
Packaging Type	Bag
Polarized to Mating Part	No
Tab Thickness	0.51mm
Tab Width	4.75mm
Temperature Range - Operating	-65°C to +105°C
Wire Insulation Diameter	3.17mm max.
Wire Size AWG	18, 20, 22
Wire Size mm²	0.35 - 0.80

Electrical

Voltage - Maximum	300V
-------------------	------

Material Info

Old Part Number	AA-5267
-----------------	---------

Reference - Drawing Numbers

Product Specification	PS-19902-011, PS-19902-013, PS-19902-014
Sales Drawing	SD-19002-003

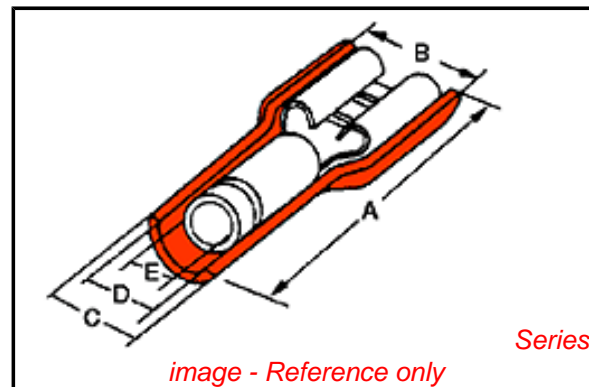

EU RoHS

ELV and RoHS Compliant
REACH SVHC Contains SVHC: No
Low-Halogen Status Low-Halogen

China RoHS



Need more information on product environmental compliance?

Email productcompliance@molex.com
 For a multiple part number RoHS Certificate of Compliance, [click here](#)

Please visit the [Contact Us](#) section for any non-product compliance questions.

Search Parts in this Series

[19002Series](#)

Use With

[19001-0003](#) , [19001-0005](#)

Application Tooling | FAQ

Tooling specifications and manuals are found by selecting the products below. Crimp Height Specifications are then contained in the Application Tooling Specification document.

Global

Description	Product #
Hand Crimp Tool	0640010800
Crimp Head for the AT-200™ Pneumatic Hand Tool	0640050800

This document was generated on 12/12/2014

PLEASE CHECK WWW.MOLEX.COM FOR LATEST PART INFORMATION