

RM4JA32MW

current measurement relay RM4-J - range
0.3..15 A - 24..240 V AC DC



Main

Range of product	Zelio Control
Product or component type	Industrial measurement and control relays
Relay type	Current measurement relay
Relay name	RM4J
Relay monitored parameters	Overcurrent or undercurrent detection
Time delay	Adjustable 0.05...30 s
Power consumption in VA	1.5...3.3 VA AC
Measurement range	300...1500 mA current DC 300...1500 mA current AC 3...15 A current DC 3...15 A current AC 1...5 A current DC 1...5 A current AC
Contacts type and composition	2 C/O

Complementary

[Us] rated supply voltage	24...240 V DC 24...240 V AC 50/60 Hz
Operating voltage tolerance	0.85...1.1 Uc
Power consumption in W	1.2 W DC
Supply frequency	50/60 Hz +/- 5 %
Width	45 mm
Output contacts	2 C/O
Measuring cycle	<= 80 ms
Internal input resistance	0.006 Ohm 0.02 Ohm 0.06 Ohm
Permissible continuous overload	2 A 20 A 7 A
Permissible non repetitive overload	15 A 100 A 10 A for <= 3 s
Setting accuracy of the switching threshold	+/- 5 %
Switching threshold drift	<= 0.5 % within the supply voltage range (0.85...1.1 Un) <= 0.06 % per degree centigrade depending permissible ambient air temperature
Setting accuracy of time delay	10 P
Time delay drift	<= 0.5 % within the supply voltage range (0.85...1.1 Un) <= 0.07 % per degree centigrade depending on temperature
Hysteresis	5...30 % adjustable of current threshold setting
Marking	CE : EMC 89/336/EEC CE : LVD 73/23/EEC
Overvoltage category	III conforming to IEC 60664-1
[Ui] rated insulation voltage	500 V conforming to IEC
Supply disconnection value	> 0.1 Uc
Operating position	Any position without derating
Connections - terminals	Screw terminals 2 x 2.5 mm ² , flexible cable without cable end Screw terminals 2 x 1.5 mm ² , flexible cable with cable end
Tightening torque	0.6...1.1 N.m

The information provided in this documentation contains general descriptions and/or technical characteristics of the performance of the products contained herein. This documentation is not intended as a substitute for and is not to be used for determining suitability or reliability of these products for specific user applications. It is the duty of any such user or integrator to perform the appropriate and complete risk analysis, evaluation and testing of the products with respect to the relevant specific application or use thereof. Neither Schneider Electric Industries SAS nor any of its affiliates or subsidiaries shall be responsible or liable for misuse of the information contained herein.

Mechanical durability	30000000 cycles
[Ith] conventional free air thermal current	8 A
[Ie] rated operational current	0.3 A at 115 V DC-13 70 °C conforming to VDE 0660 0.3 A at 115 V DC-13 70 °C conforming to IEC 60947-5-1/1991 0.1 A at 250 V DC-13 70 °C conforming to VDE 0660 0.1 A at 250 V DC-13 70 °C conforming to IEC 60947-5-1/1991 3 A at 250 V AC-15 70 °C conforming to VDE 0660 3 A at 250 V AC-15 70 °C conforming to IEC 60947-5-1/1991 3 A at 24 V AC-15 70 °C conforming to VDE 0660 3 A at 24 V AC-15 70 °C conforming to IEC 60947-5-1/1991 3 A at 115 V AC-15 70 °C conforming to VDE 0660 3 A at 115 V AC-15 70 °C conforming to IEC 60947-5-1/1991 2 A at 24 V DC-13 70 °C conforming to VDE 0660 2 A at 24 V DC-13 70 °C conforming to IEC 60947-5-1/1991
Switching capacity in mA	10 mA at 12 V
Switching voltage	250 V AC <= 440 V AC
Contacts material	90/10 silver nickel contacts
Number of cables	2
CAD overall width	45 mm
CAD overall depth	80 mm
Terminals description ISO n°1	(15-16-18)OC (25-26-28)OC (A1-A2)CO (C-B1-B2-B3)CO
Output relay state	Tripped if A measured > A set Tripped if V measured > V set
9 mm pitches	5
Product weight	0.204 kg

Environment

Standards	EN/IEC 60255-6
Product certifications	CSA GL UL
Ambient air temperature for storage	-40...85 °C
Ambient air temperature for operation	-20...65 °C
Relative humidity	15...85 % 3K3 conforming to IEC 60721-3-3
Shock resistance	15 gn for 11 ms conforming to IEC 60255-21-1
IP degree of protection	IP50 (casing) conforming to IEC 60529 IP20 (terminals) conforming to IEC 60529
Pollution degree	3 conforming to IEC 60664-1
Dielectric test voltage	2.5 kV
Non-dissipating shock wave	4.8 kV
Resistance to electrostatic discharge	8 kV air conforming to IEC 61000-4-2 level 3 6 kV contact conforming to IEC 61000-4-2 level 3
Resistance to electromagnetic fields	10 V/m conforming to IEC 61000-4-3 level 3
Resistance to fast transients	2 kV conforming to IEC 61000-4-4 level 3
Protection against electric shocks	2 kV conforming to IEC 61000-4-5 level 3
Disturbance radiated/conducted	CISPR 11 group 1 - class A CISPR 22 - class A

Current Measurement Relays

Dimensions

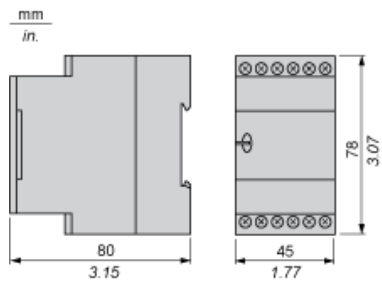

Current Measurement Relays

Rail mounting

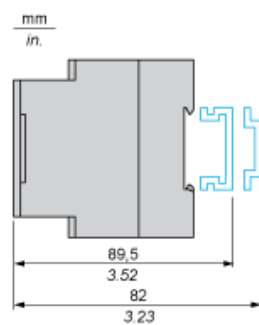

Screw fixing

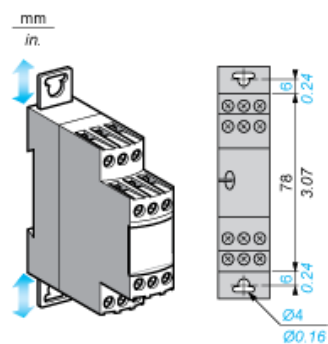

Current Measurement Relays

RM4JA01 Wiring Diagram

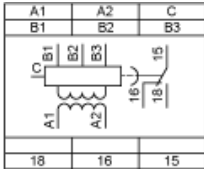

- A1- Supply voltage
- A2
- B1, Currents to be measured (see table below)
- B2,
- B3, C

Connection and current values to be measured	
B1-C	3...30 mA
B2-C	10...100 mA
B3-C	0.1...1 A

RM4JA31 Wiring Diagram

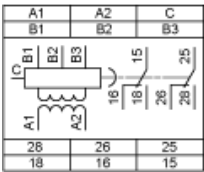

- A1- Supply voltage
- A2
- B1, Currents to be measured (see table below)
- B2,
- B3, C

Connection and current values to be measured	
B1-C	3...30 mA
B2-C	10...100 mA
B3-C	0.1...1 A

RM4JA32 Wiring Diagram

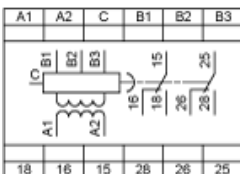

- A1- Supply voltage
- A2
- B1, Currents to be measured (see table below)
- B2,
- B3, C

Connection and current values to be measured	
B1-C	0.3...1.5 A
B2-C	1...5 A
B3-C	3...15 A

Example: Detection of Blockage on a Crusher (Overcurrent Function)

Current measured ≤ 15 A

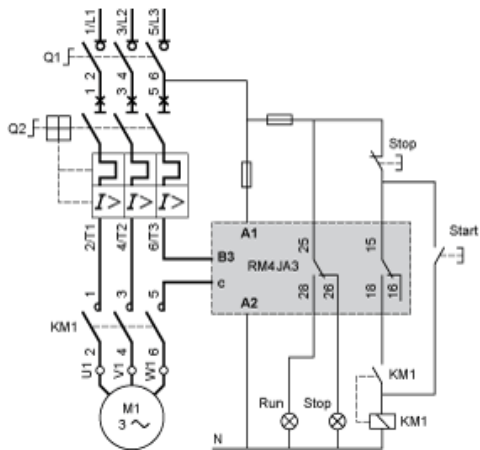

Current measured > 15 A

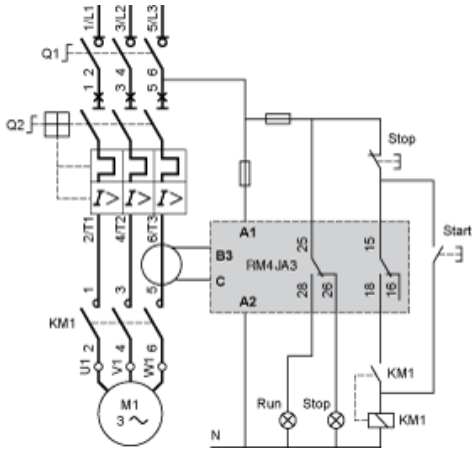

Electrical Durability and Load Limit Curves

AC Load

Curve 1: Electrical durability of contacts on resistive load in millions of operating cycles

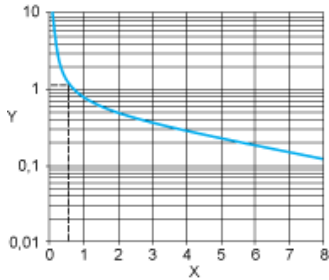

X Current broken in A
Y Millions of operating cycles

Curve 2: Reduction factor k for inductive loads (applies to values taken from durability Curve 1)

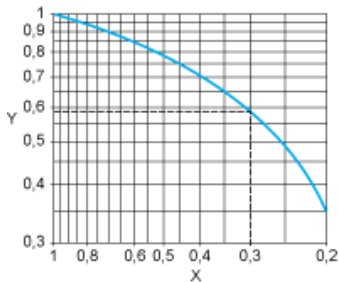

X Power factor on breaking (cos φ)
Y Reduction factor K

Example: An LC1-F185 contactor supplied with 115 V/50 Hz for a consumption of 55 VA or a current consumption equal to 0.5 A and cos φ = 0.3.

For 0.5 A, curve 1 indicates a durability of approximately 1.5 million operating cycles.

As the load is inductive, it is necessary to apply a reduction coefficient k to this number of cycles as indicated by curve 2.

For cos φ = 0.3: k = 0.6

The electrical durability therefore becomes:

$$1.5 \times 10^6 \text{ operating cycles} \times 0.6 = 900\,000 \text{ operating cycles}$$

DC Load

Load limit curve

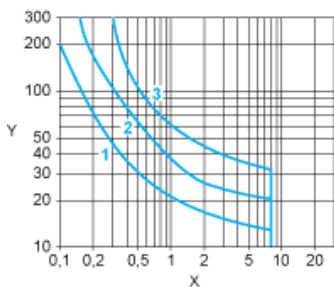

X Current in A
Y Voltage in V
1 L/R = 20 ms
2 L/R with load protection diode
3 Resistive load

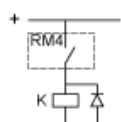

Function Diagram

Overcurrent Detection

Function ">"

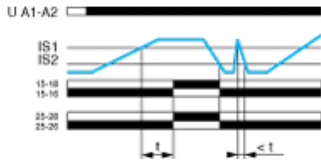

- t Time delay
- U Supply voltage
- A1-
- A2
- IS1 Setting current threshold
- IS2 Current measured (see diagram below)
- 15-18 Output relays connections (refer to Connections and Schema)
- 15-16;
- 25-28,
- 25-26

Relay status: black color = energized.

NOTE: Hysteresis is adjustable between 5 and 30%: for overcurrent $h = (IS1 - IS2) / IS1$. A measuring cycle lasts only 80 ms, which allows rapid detection of changes in current.



- (1) Measurement
- (2) U drop < 1 V
- (3) Load

NOTE: The measurement ranges can be extended by means of a current transformer, the secondary of which is connected to the measuring terminals of the RM4 relay, or by means of a resistor connected in parallel with the measuring input.

Function Diagram

Undercurrent Detection

Function "<"

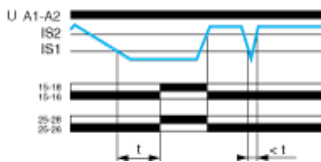

- t Time delay
- U Supply voltage
- A1-
- A2
- IS1 Setting current threshold
- IS2 Current measured (see wiring diagram below)
- 15-18 Output relays connections (refer to Connections and Schema)
- 15-16;
- 25-28,
- 25-26

Relay status: black color = energized.

NOTE: Hysteresis is adjustable between 5 and 30%: for undercurrent $h = (IS2 - IS1) / IS1$. A measuring cycle lasts only 80 ms, which allows rapid detection of changes in current.



- (1) Measurement
- (2) U drop < 1 V
- (3) Load

NOTE: The measurement ranges can be extended by means of a current transformer, the secondary of which is connected to the measuring terminals of the RM4 relay, or by means of a resistor connected in parallel with the measuring input.