

# Analog Devices Welcomes Hittite Microwave Corporation

NO CONTENT ON THE ATTACHED DOCUMENT HAS CHANGED



**THIS PAGE INTENTIONALLY LEFT BLANK**

## GaAs MMIC PASSIVE FREQUENCY DOUBLER CHIP, 1.3 - 4.0 GHz INPUT

### Typical Applications

The HMC158 is suitable for:

- Wireless Local Loop
- LMDS, VSAT, and Point-to-Point Radios
- UNII & HiperLAN
- Test Equipment

### Features

- Conversion Loss: 15 dB
- Fo, 3Fo, 4Fo Isolation: 40 dB
- Input Drive Level: 10 to 20 dBm
- Die Size: 1.0 x 1.15 x 0.18 mm

### Functional Diagram

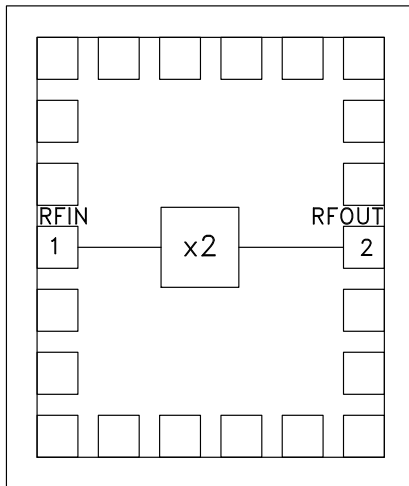

### General Description

The HMC158 is a miniature frequency doubler in a MMIC die. Suppression of undesired fundamental and higher order harmonics is 40 dB typical with respect to input signal level. The doubler uses the same diode/balun technology used in Hittite MMIC mixers, features small size and requires no DC bias.

### Electrical Specifications, $T_A = +25^\circ \text{C}$ , As a Function of Drive Level

Parameter	Input = +10 dBm			Input = +15 dBm			Input = +20 dBm			Units
	Min.	Typ.	Max.	Min.	Typ.	Max.	Min.	Typ.	Max.	
Frequency Range, Input	1.7 - 4.0			1.7 - 3.5			1.3 - 4.0			GHz
Frequency Range, Output	3.4 - 8.0			3.4 - 7.0			2.6 - 8.0			GHz
Conversion Loss		18	22		15	18		15	18	dB
FO Isolation (with respect to input level)				37	45					dB
3FO Isolation (with respect to input level)				40	50					dB
4FO Isolation (with respect to input level)				32	40					dB

**GaAs MMIC PASSIVE FREQUENCY DOUBLER CHIP, 1.3 - 4.0 GHz INPUT**

**Conversion Gain vs. Drive Level**

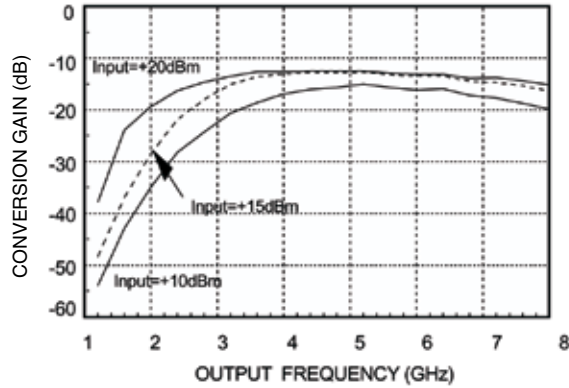

**Isolation @ +15 dBm Drive Level\***

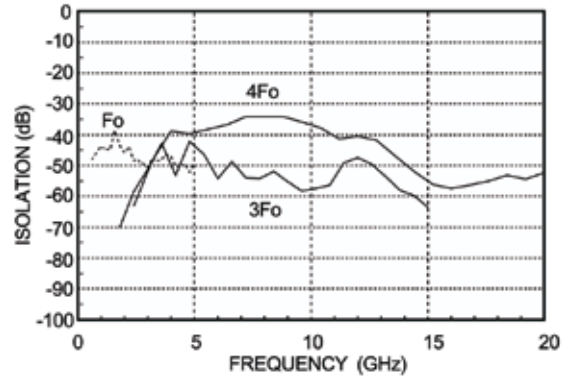

\*With respect to input level

**Input Return Loss vs. Drive Level**

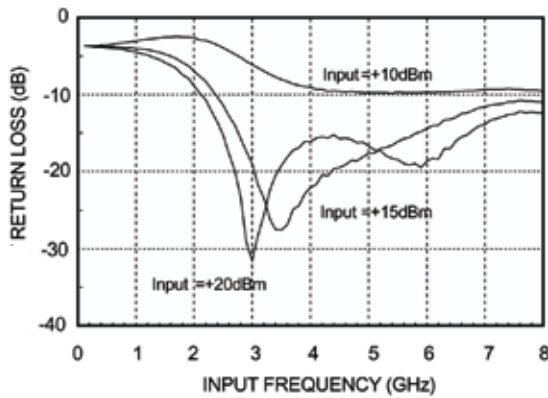

**Output Return Loss vs. Drive Level**

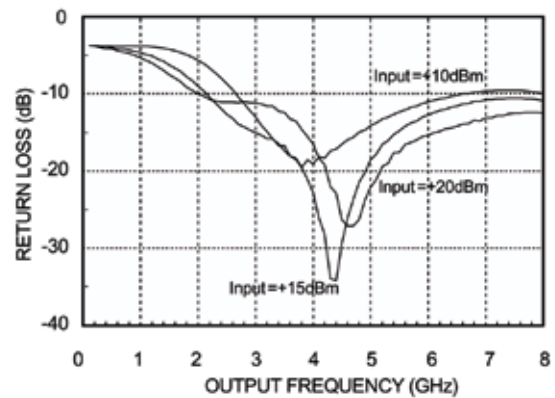

**Absolute Maximum Ratings**

Input Drive	+27 dBm
Storage Temperature	-65 to +150 °C
Operating Temperature	-55 to +85 °C
ESD Sensitivity (HBM)	Class 1A



**ELECTROSTATIC SENSITIVE DEVICE  
OBSERVE HANDLING PRECAUTIONS**

**GaAs MMIC PASSIVE FREQUENCY DOUBLER CHIP, 1.3 - 4.0 GHz INPUT**

**Outline Drawing**

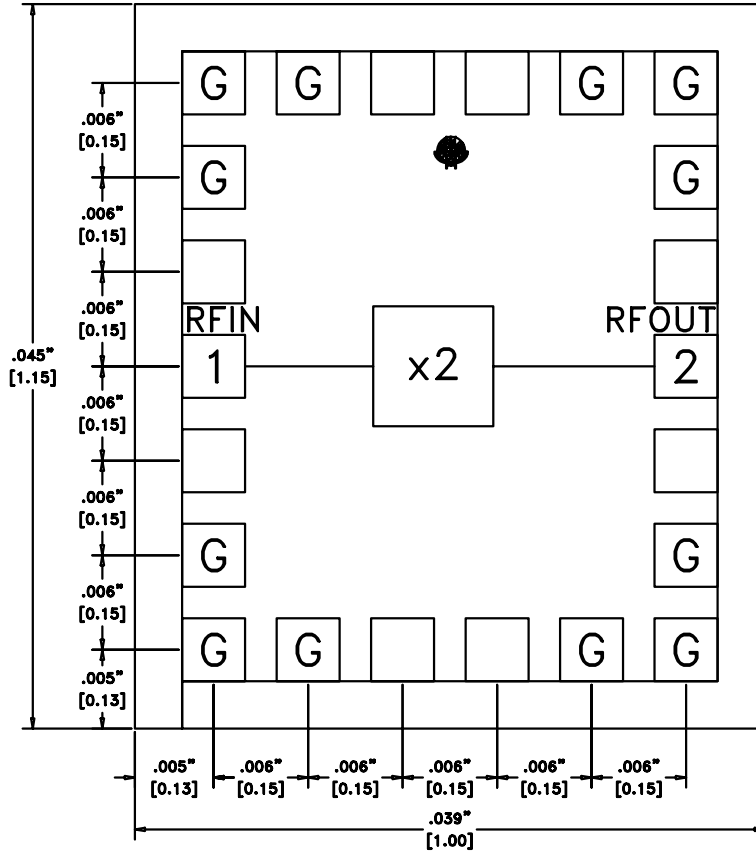

**Die Packaging Information [1]**



Standard	Alternate [2]
WP-2 (Waffle Pack)	[2]

[1] Refer to the "Packaging Information" section for die packaging dimensions.  
 [2] Reference this suffix only when ordering alternate die packaging.

NOTES:

1. THREE PADS ON EACH CORNER MUST BE BONDED TO GROUND (12 TOTAL).
2. ALL DIMENSIONS IN INCHES [MILLIMETERS]
3. ALL TOLERANCES ARE 0.001 [0.025]
4. DIE THICKNESS IS 0.007 [0.178]
5. BOND PADS ARE 0.004 [0.100] SQUARE
6. EQUALLY SPACED AT 0.006 [0.150] CENTERS
7. BACKSIDE METALLIZATION: NONE
8. BOND PAD METALLIZATION: GOLD

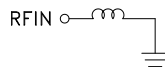
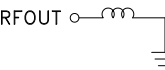
**Pad Description**

Pad Number	Function	Description	Interface Schematic
1	RFIN	Pad is DC coupled and matched to 50 ohms.	
2	RFOUT	Pad is DC coupled and matched to 50 ohms.	
Die Bottom	GND	DC / RF Ground	

**GaAs MMIC PASSIVE FREQUENCY  
DOUBLER CHIP, 1.3 - 4.0 GHz INPUT****Handling Precautions**

Follow these precautions to avoid permanent damage.

**Storage:** All bare die are placed in either Waffle or Gel based ESD protective containers, and then sealed in an ESD protective bag for shipment. Once the sealed ESD protective bag has been opened, all die should be stored in a dry nitrogen environment.

**Cleanliness:** Handle the chips in a clean environment. DO NOT attempt to clean the chip using liquid cleaning systems.

**Static Sensitivity:** Follow ESD precautions to protect against ESD strikes.

**Transients:** Suppress instrument and bias supply transients while bias is applied. Use shielded signal and bias cables to minimize inductive pick-up.

**General Handling:** Handle the chip along the edges with a vacuum collet or with a sharp pair of bent tweezers. The surface of the chip may have fragile air bridges and should not be touched with vacuum collet, tweezers, or fingers.

**Mounting****Epoxy Die Attach:**

Apply a minimum amount of epoxy to the mounting surface so that a thin epoxy fillet is observed around the perimeter of the chip once it is placed into position.

Cure epoxy per the manufacturer's schedule.

**Wire Bonding**

Ball or wedge bond with 1.0 diameter pure gold wire. Thermosonic wirebonding with a nominal stage temperature of 150 °C and a ball bonding force of 40 to 50 grams or wedge bonding force of 18 to 22 grams is recommended. Use the minimum level of ultrasonic energy to achieve reliable wirebonds. Wirebonds should be started on the chip and terminated on the package. RF bonds should be as short as possible.