

# MC74VHC132

## Quad 2-Input NAND Schmitt Trigger

The MC74VHC132 is an advanced high speed CMOS Schmitt NAND trigger fabricated with silicon gate CMOS technology. It achieves high speed operation similar to equivalent Bipolar Schottky TTL while maintaining CMOS low power dissipation.

Pin configuration and function are the same as the MC74VHC00, but the inputs have hysteresis and, with its Schmitt trigger function, the VHC132 can be used as a line receiver which will receive slow input signals.

The internal circuit is composed of three stages, including a buffer output which provides high noise immunity and stable output. The inputs tolerate voltages up to 7.0 V, allowing the interface of 5.0 V systems to 3.0 V systems.

### Features

- High Speed:  $t_{PD} = 4.9$  ns (Typ) at  $V_{CC} = 5.0$  V
- Low Power Dissipation:  $I_{CC} = 2$   $\mu$ A (Max) at  $T_A = 25^\circ$ C
- High Noise Immunity:  $V_{NIH} = V_{NIL} = 28\%$   $V_{CC}$
- Power Down Protection Provided on Inputs
- Balanced Propagation Delays
- Designed for 2.0 V to 5.5 V Operating Range
- Low Noise:  $V_{OLP} = 0.8$  V (Max)
- Pin and Function Compatible with Other Standard Logic Families
- Latchup Performance Exceeds 300mA
- ESD Performance:
  - Human Body Model > 2000 V;
  - Machine Model > 200 V
- Chip Complexity: 72 FETs or 18 Equivalent Gates
- These Devices are Pb-Free and are RoHS Compliant

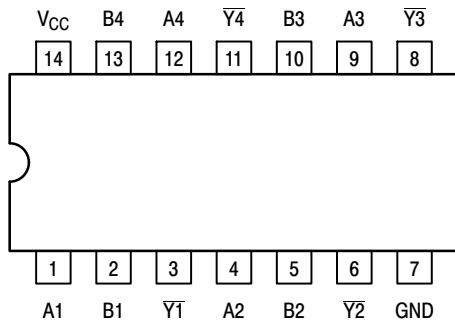

(Top View)  
**Figure 1. Pinout: 14-Lead Packages**



**ON Semiconductor**<sup>®</sup>

<http://onsemi.com>

### MARKING DIAGRAMS

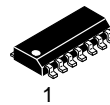

**SOIC-14  
 D SUFFIX  
 CASE 751A**

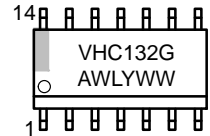

**TSSOP-14  
 DT SUFFIX  
 CASE 948G**

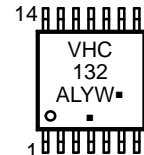

A = Assembly Location  
 WL, L = Wafer Lot  
 Y = Year  
 WW, W = Work Week  
 G or  $\square$  = Pb-Free Package

(Note: Microdot may be in either location)

### FUNCTION TABLE

Inputs		Output
A	B	$\bar{Y}$
L	L	H
L	H	H
H	L	H
H	H	L

### ORDERING INFORMATION

See detailed ordering and shipping information in the package dimensions section on page 4 of this data sheet.

# MC74VHC132

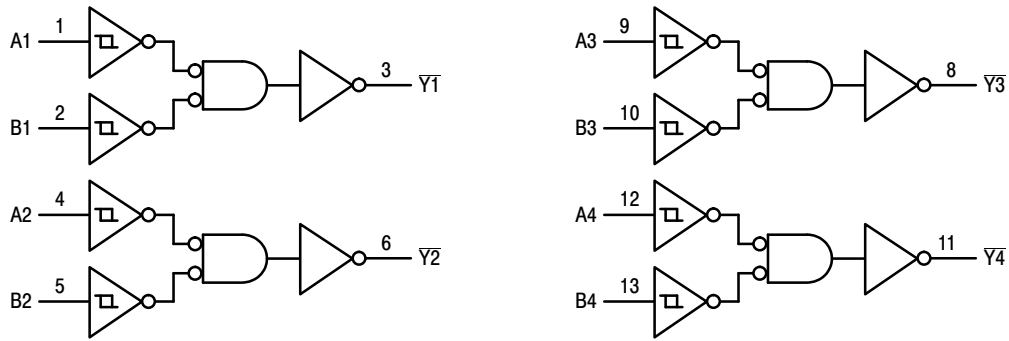

Figure 2. Logic Diagram

## MAXIMUM RATINGS

Symbol	Parameter	Value	Unit
$V_{CC}$	DC Supply Voltage	-0.5 to +7.0	V
$V_{in}$	DC Input Voltage	-0.5 to +7.0	V
$V_{out}$	DC Output Voltage	-0.5 to $V_{CC} + 0.5$	V
$I_{IK}$	Input Diode Current	-20	mA
$I_{OK}$	Output Diode Current	$\pm 20$	mA
$I_{out}$	DC Output Current, per Pin	$\pm 25$	mA
$I_{CC}$	DC Supply Current, $V_{CC}$ and GND Pins	$\pm 50$	mA
$P_D$	Power Dissipation in Still Air, SOIC Packages† TSSOP Package†	500 450	mW
$T_{stg}$	Storage Temperature	-65 to +150	°C

This device contains protection circuitry to guard against damage due to high static voltages or electric fields. However, precautions must be taken to avoid applications of any voltage higher than maximum rated voltages to this high-impedance circuit. For proper operation,  $V_{in}$  and  $V_{out}$  should be constrained to the range  $GND \leq (V_{in} \text{ or } V_{out}) \leq V_{CC}$ .

Unused inputs must always be tied to an appropriate logic voltage level (e.g., either GND or  $V_{CC}$ ). Unused outputs must be left open.

Stresses exceeding those listed in the Maximum Ratings table may damage the device. If any of these limits are exceeded, device functionality should not be assumed, damage may occur and reliability may be affected.

†Derating - SOIC Packages: - 7 mW/°C from 65° to 125°C  
TSSOP Package: - 6.1 mW/°C from 65° to 125°C

## RECOMMENDED OPERATING CONDITIONS

Symbol	Parameter	Min	Max	Unit
$V_{CC}$	DC Supply Voltage	2.0	5.5	V
$V_{in}$	DC Input Voltage	0	5.5	V
$V_{out}$	DC Output Voltage	0	$V_{CC}$	V
$T_A$	Operating Temperature, All Package Types	-55	+ 125	°C

Functional operation above the stresses listed in the Recommended Operating Ranges is not implied. Extended exposure to stresses beyond the Recommended Operating Ranges limits may affect device reliability.

# MC74VHC132

## DC ELECTRICAL CHARACTERISTICS

Symbol	Parameter	Test Conditions	V <sub>CC</sub> V	T <sub>A</sub> = 25°C			T <sub>A</sub> = -55 to +125°C		Unit
				Min	Typ	Max	Min	Max	
V <sub>T+</sub>	Positive Threshold Voltage (Figure 5)		3.0 4.5 5.5			2.20 3.15 3.85		2.20 3.15 3.85	V
V <sub>T-</sub>	Negative Threshold Voltage (Figure 5)		3.0 4.5 5.5	0.9 1.35 1.65			0.90 1.35 1.65		V
V <sub>H</sub>	Hysteresis Voltage (Figure 5)		3.0 4.5 5.5	0.30 0.40 0.50		1.20 1.40 1.60	0.30 0.40 0.50	1.20 1.40 1.60	V
V <sub>OH</sub>	Minimum High-Level Output Voltage	V <sub>in</sub> = V <sub>IH</sub> or V <sub>IL</sub> I <sub>OH</sub> = -50 μA	2.0 3.0 4.5	1.9 2.9 4.4	2.0 3.0 4.5		1.9 2.9 4.4		V
		V <sub>in</sub> = V <sub>IH</sub> or V <sub>IL</sub> I <sub>OH</sub> = -4 mA I <sub>OH</sub> = -8 mA	3.0 4.5	2.58 3.94			2.48 3.80		
V <sub>OL</sub>	Maximum Low-Level Output Voltage	V <sub>in</sub> = V <sub>IH</sub> or V <sub>IL</sub> I <sub>OL</sub> = 50 μA	2.0 3.0 4.5		0 0 0	0.1 0.1 0.1		0.1 0.1 0.1	V
		V <sub>in</sub> = V <sub>IH</sub> or V <sub>IL</sub> I <sub>OL</sub> = 4 mA I <sub>OL</sub> = 8 mA	3.0 4.5			0.36 0.36		0.44 0.44	
I <sub>in</sub>	Maximum Input Leakage Current	V <sub>in</sub> = 5.5 V or GND	0 to 5.5			± 0.1		± 1.0	μA
I <sub>CC</sub>	Maximum Quiescent Supply Current	V <sub>in</sub> = V <sub>CC</sub> or GND	5.5			2.0		20.0	μA

Product parametric performance is indicated in the Electrical Characteristics for the listed test conditions, unless otherwise noted. Product performance may not be indicated by the Electrical Characteristics if operated under different conditions.

## AC ELECTRICAL CHARACTERISTICS (Input t<sub>r</sub> = t<sub>f</sub> = 3.0ns)

Symbol	Parameter	Test Conditions	T <sub>A</sub> = 25°C			T <sub>A</sub> = -55 to +125°C		Unit
			Min	Typ	Max	Min	Max	
t <sub>PLH</sub> , t <sub>PHL</sub>	Maximum Propagation Delay, A or B to $\bar{Y}$	V <sub>CC</sub> = 3.3 ± 0.3 V C <sub>L</sub> = 15 pF C <sub>L</sub> = 50 pF		7.6 10.1	11.9 15.4	1.0 1.0	14.0 17.5	ns
		V <sub>CC</sub> = 5.0 ± 0.5 V C <sub>L</sub> = 15 pF C <sub>L</sub> = 50 pF		4.9 6.4	7.7 9.7	1.0 1.0	9.0 11.0	
C <sub>in</sub>	Maximum Input Capacitance			4 10			10	pF

C <sub>PD</sub>	Power Dissipation Capacitance (Note 1)	Typical @ 25°C, V <sub>CC</sub> = 5.0 V		Unit
		16		
				pF

1. C<sub>PD</sub> is defined as the value of the internal equivalent capacitance which is calculated from the operating current consumption without load. Average operating current can be obtained by the equation: I<sub>CC(OPR)</sub> = C<sub>PD</sub> • V<sub>CC</sub> • f<sub>in</sub> + I<sub>CC</sub>/4 (per gate). C<sub>PD</sub> is used to determine the no-load dynamic power consumption; P<sub>D</sub> = C<sub>PD</sub> • V<sub>CC</sub><sup>2</sup> • f<sub>in</sub> + I<sub>CC</sub> • V<sub>CC</sub>.

## NOISE CHARACTERISTICS (Input t<sub>r</sub> = t<sub>f</sub> = 3.0ns, C<sub>L</sub> = 50pF, V<sub>CC</sub> = 5.0 V)

Symbol	Characteristic	T <sub>A</sub> = 25°C		Unit
		Typ	Max	
V <sub>OLP</sub>	Quiet Output Maximum Dynamic V <sub>OL</sub>	0.3	0.8	V
V <sub>OLV</sub>	Quiet Output Minimum Dynamic V <sub>OL</sub>	-0.3	-0.8	V
V <sub>IHD</sub>	Minimum High Level Dynamic Input Voltage		3.5	V
V <sub>ILD</sub>	Maximum Low Level Dynamic Input Voltage		1.5	V

# MC74VHC132

## ORDERING INFORMATION

Device	Package	Shipping†
MC74VHC132DG	SOIC-14 (Pb-Free)	55 Units / Rail
MC74VHC132DR2G	SOIC-14 (Pb-Free)	2500 Tape & Reel
M74VHC132DTR2G	TSSOP-14*	2500 Tape & Reel

†For information on tape and reel specifications, including part orientation and tape sizes, please refer to our Tape and Reel Packaging Specifications Brochure, BRD8011/D.

\*This package is inherently Pb-Free.

# MC74VHC132

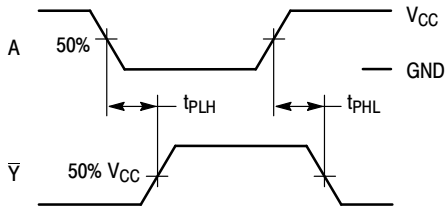
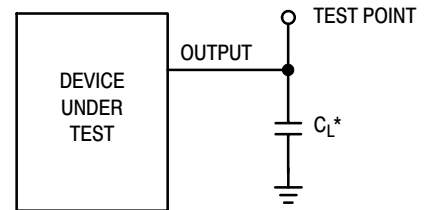

Figure 3. Switching Waveforms



\*Includes all probe and jig capacitance

Figure 4. Test Circuit

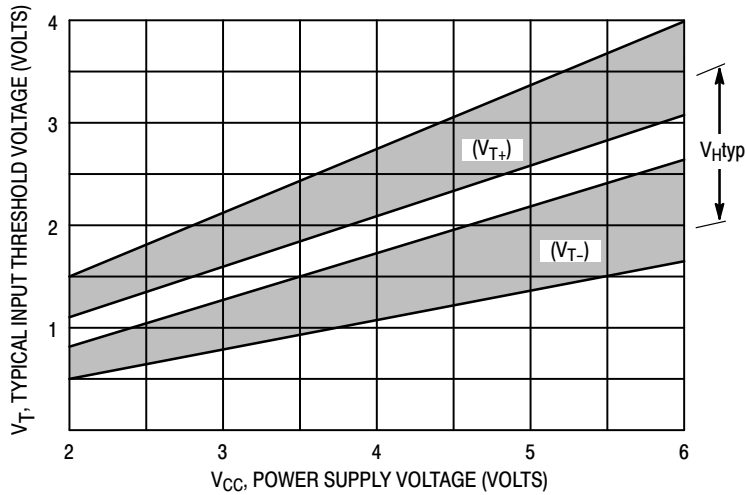
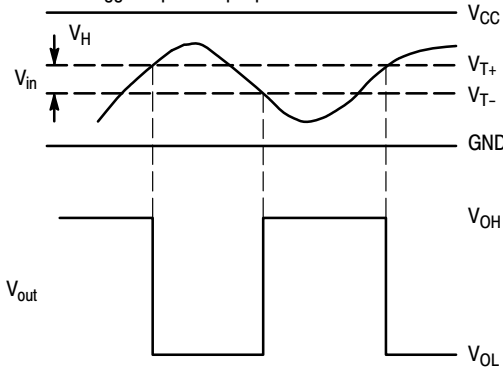

Figure 5. Typical Input Threshold,  $V_{T+}$ ,  $V_{T-}$  versus Power Supply Voltage

(a) A Schmitt-Trigger Squares Up Inputs With Slow Rise and Fall Times



(b) A Schmitt-Trigger Offers Maximum Noise Immunity

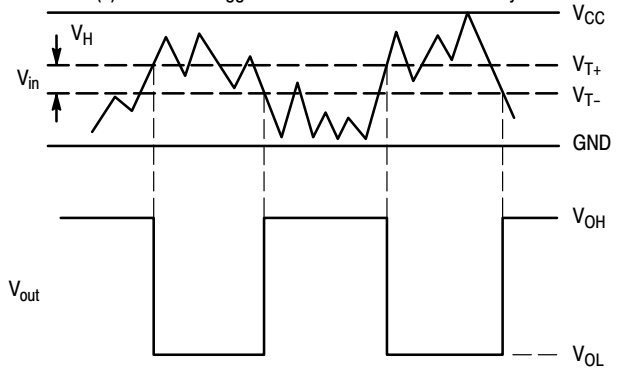

Figure 6. Typical Schmitt-Trigger Applications

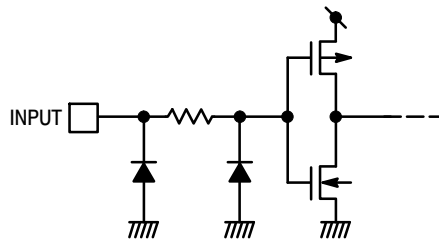
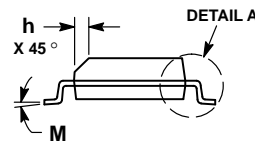
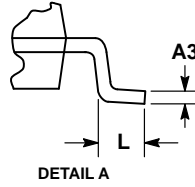
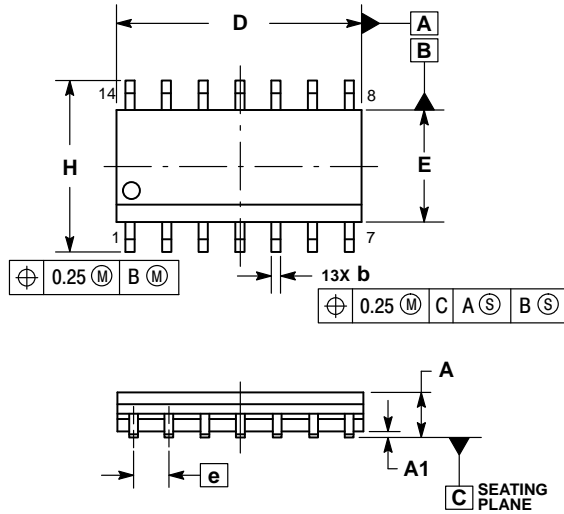

Figure 7. Input Equivalent Circuit

# MC74VHC132

## PACKAGE DIMENSIONS

SOIC-14  
CASE 751A-03  
ISSUE K



NOTES:

1. DIMENSIONING AND TOLERANCING PER ASME Y14.5M, 1994.
2. CONTROLLING DIMENSION: MILLIMETERS.
3. DIMENSION b DOES NOT INCLUDE DAMBAR PROTRUSION. ALLOWABLE PROTRUSION SHALL BE 0.13 TOTAL IN EXCESS OF AT MAXIMUM MATERIAL CONDITION.
4. DIMENSIONS D AND E DO NOT INCLUDE MOLD PROTRUSIONS.
5. MAXIMUM MOLD PROTRUSION 0.15 PER SIDE.

DIM	MILLIMETERS		INCHES	
	MIN	MAX	MIN	MAX
A	1.35	1.75	0.054	0.068
A1	0.10	0.25	0.004	0.010
A3	0.19	0.25	0.008	0.010
b	0.35	0.49	0.014	0.019
D	8.55	8.75	0.337	0.344
E	3.80	4.00	0.150	0.157
e	1.27 BSC		0.050 BSC	
H	5.80	6.20	0.228	0.244
h	0.25	0.50	0.010	0.019
L	0.40	1.25	0.016	0.049
M	0°	7°	0°	7°

### SOLDERING FOOTPRINT\*

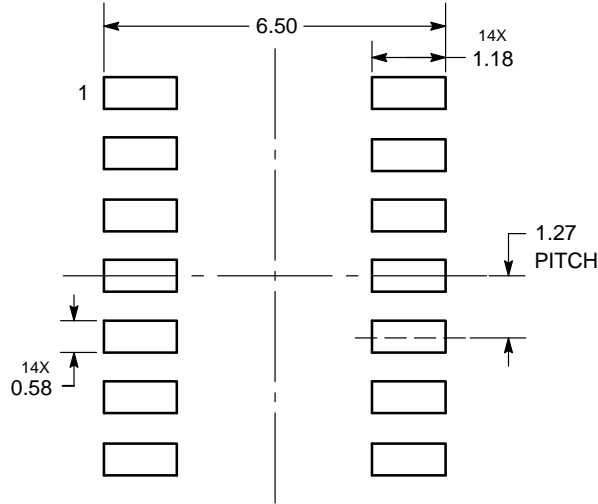

DIMENSIONS: MILLIMETERS

\*For additional information on our Pb-Free strategy and soldering details, please download the ON Semiconductor Soldering and Mounting Techniques Reference Manual, SOLDERRM/D.

# MC74VHC132

## PACKAGE DIMENSIONS

TSSOP-14  
CASE 948G  
ISSUE B

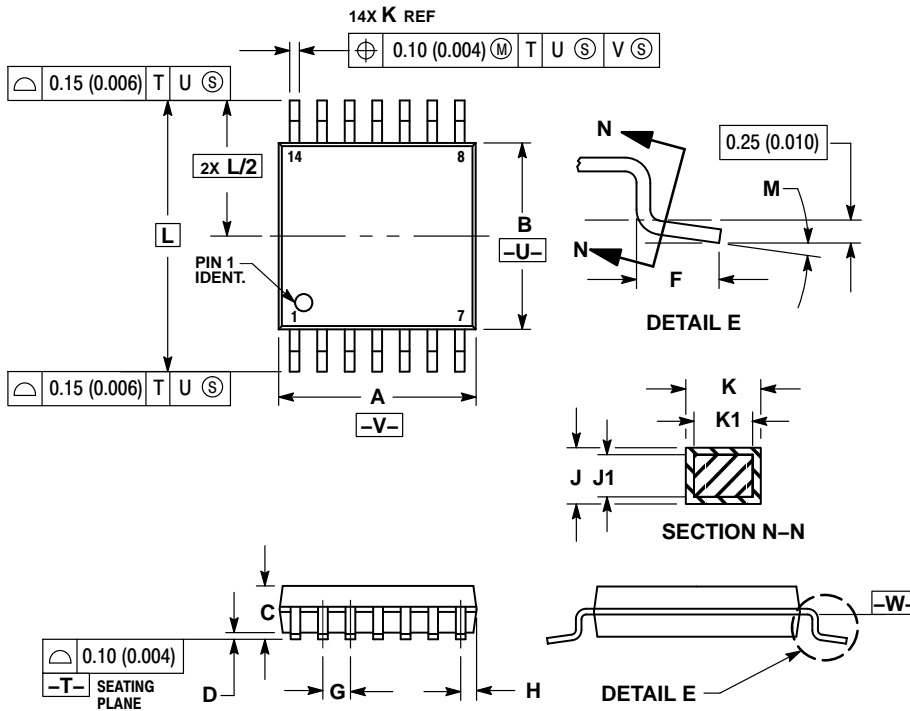

- NOTES:
1. DIMENSIONING AND TOLERANCING PER ANSI Y14.5M, 1982.
  2. CONTROLLING DIMENSION: MILLIMETER.
  3. DIMENSION A DOES NOT INCLUDE MOLD FLASH, PROTRUSIONS OR GATE BURRS. MOLD FLASH OR GATE BURRS SHALL NOT EXCEED 0.15 (0.006) PER SIDE.
  4. DIMENSION B DOES NOT INCLUDE INTERLEAD FLASH OR PROTRUSION. INTERLEAD FLASH OR PROTRUSION SHALL NOT EXCEED 0.25 (0.010) PER SIDE.
  5. DIMENSION K DOES NOT INCLUDE DAMBAR PROTRUSION. ALLOWABLE DAMBAR PROTRUSION SHALL BE 0.08 (0.003) TOTAL IN EXCESS OF THE K DIMENSION AT MAXIMUM MATERIAL CONDITION.
  6. TERMINAL NUMBERS ARE SHOWN FOR REFERENCE ONLY.
  7. DIMENSION A AND B ARE TO BE DETERMINED AT DATUM PLANE -W-.

DIM	MILLIMETERS		INCHES	
	MIN	MAX	MIN	MAX
A	4.90	5.10	0.193	0.200
B	4.30	4.50	0.169	0.177
C	---	1.20	---	0.047
D	0.05	0.15	0.002	0.006
F	0.50	0.75	0.020	0.030
G	0.65 BSC		0.026 BSC	
H	0.50	0.60	0.020	0.024
J	0.09	0.20	0.004	0.008
J1	0.09	0.16	0.004	0.006
K	0.19	0.30	0.007	0.012
K1	0.19	0.25	0.007	0.010
L	6.40 BSC		0.252 BSC	
M	0°	8°	0°	8°

### SOLDERING FOOTPRINT

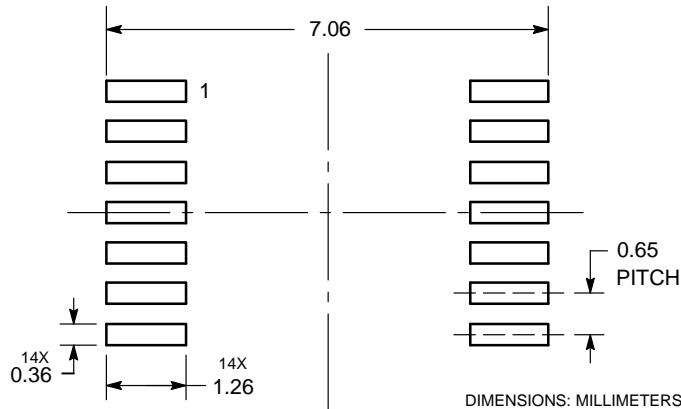

ON Semiconductor and the are registered trademarks of Semiconductor Components Industries, LLC (SCILLC) or its subsidiaries in the United States and/or other countries. SCILLC owns the rights to a number of patents, trademarks, copyrights, trade secrets, and other intellectual property. A listing of SCILLC's product/patent coverage may be accessed at [www.onsemi.com/site/pdf/Patent-Marking.pdf](http://www.onsemi.com/site/pdf/Patent-Marking.pdf). SCILLC reserves the right to make changes without further notice to any products herein. SCILLC makes no warranty, representation or guarantee regarding the suitability of its products for any particular purpose, nor does SCILLC assume any liability arising out of the application or use of any product or circuit, and specifically disclaims any and all liability, including without limitation special, consequential or incidental damages. "Typical" parameters which may be provided in SCILLC data sheets and/or specifications can and do vary in different applications and actual performance may vary over time. All operating parameters, including "Typicals" must be validated for each customer application by customer's technical experts. SCILLC does not convey any license under its patent rights nor the rights of others. SCILLC products are not designed, intended, or authorized for use as components in systems intended for surgical implant into the body, or other applications intended to support or sustain life, or for any other application in which the failure of the SCILLC product could create a situation where personal injury or death may occur. Should Buyer purchase or use SCILLC products for any such unintended or unauthorized application, Buyer shall indemnify and hold SCILLC and its officers, employees, subsidiaries, affiliates, and distributors harmless against all claims, costs, damages, and expenses, and reasonable attorney fees arising out of, directly or indirectly, any claim of personal injury or death associated with such unintended or unauthorized use, even if such claim alleges that SCILLC was negligent regarding the design or manufacture of the part. SCILLC is an Equal Opportunity/Affirmative Action Employer. This literature is subject to all applicable copyright laws and is not for resale in any manner.

### PUBLICATION ORDERING INFORMATION

#### LITERATURE FULFILLMENT:

Literature Distribution Center for ON Semiconductor  
P.O. Box 5163, Denver, Colorado 80217 USA  
Phone: 303-675-2175 or 800-344-3860 Toll Free USA/Canada  
Fax: 303-675-2176 or 800-344-3867 Toll Free USA/Canada  
Email: [orderlit@onsemi.com](mailto:orderlit@onsemi.com)

**N. American Technical Support:** 800-282-9855 Toll Free  
USA/Canada  
**Europe, Middle East and Africa Technical Support:**  
Phone: 421 33 790 2910  
**Japan Customer Focus Center**  
Phone: 81-3-5817-1050

**ON Semiconductor Website:** [www.onsemi.com](http://www.onsemi.com)  
**Order Literature:** <http://www.onsemi.com/orderlit>

For additional information, please contact your local Sales Representative

# Quad 2-Input NAND Gate with Schmitt Trigger Input



**ON Semiconductor**

## Ordering Information

Product	Pins	Package	Container Type	Qty.
MC74VHC132DG	14	SOIC	Tube	55
MC74VHC132DR2G	14	SOIC	Tape & Reel	2500
MC74VHC132DTR2G	14	TSSOP	Tape & Reel	2500