

**SP5001 Series 4 Channel Common Mode Filter with ESD Protection**    

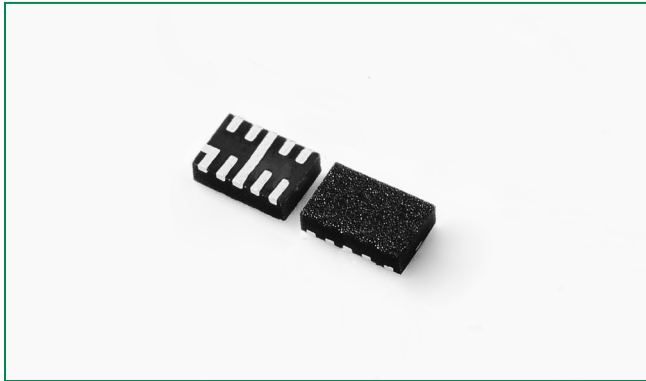

**Description**

The SP5001 Series is a highly integrated Common Mode Filter (CMF) providing both ESD protection and EMI common mode noise filtering for systems using high speed differential serial interfaces, such as MIPI D-PHY or HDMI.

The SP5001 Series can protect and filter two differential line pairs in a small RoHS-compliant TDFN-10 package, with cost and space savings over discrete solutions.

**Pinout**

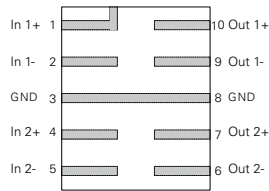

Note :This drawing is not to scale.

**Features**

- Large differential bandwidth > 2.5 GHz
- High Common Mode Stop Band Attenuation:
  - > 25 dB at 700 MHz
  - > 30 dB at 800 MHz
- ±15kV ESD protection per channel (IEC 61000-4-2 Level 4, contact discharge)
- TDFN-10 2.50mm × 2.00mm × 0.75mm package with 0.50mm lead pitch
- RoHS-compliant, Lead-free packaging
- AEC-Q101 qualified

**Functional Block Diagram**

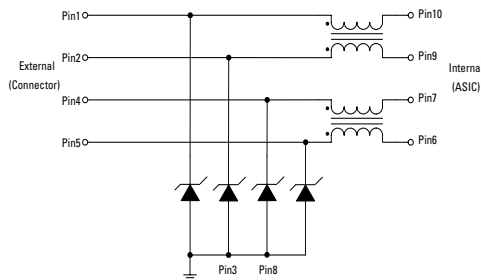

**Applications**

- HDMI/DVI Display in Mobile Phones
- MIPI D-PHY (CSI-2, DSI, etc) in Mobile Phones and Digital Still Cameras

### Absolute Maximum Ratings

Symbol	Parameter	Value	Units
$I_{DC}$	DC Current Per Line	100	mA
$P_{DC}$	DC Package Power Rating	0.5	W
$T_{OP}$	Operating Temperature	-40 to 125	°C
$T_{STOR}$	Storage Temperature	-55 to 150	°C

CAUTION: Stresses above those listed in "Absolute Maximum Ratings" may cause permanent damage to the device. This is a stress only rating and operation of the device at these or any other conditions above those indicated in the operational sections of this specification is not implied.

### Thermal Information

Parameter	Rating	Units
Storage Temperature Range	-55 to 150	°C
Maximum Junction Temperature	150	°C
Maximum Lead Temperature (Soldering 20-40s)	260	°C

### Electrical Characteristics ( $T_{OP}=25^{\circ}C$ )

Parameter	Symbol	Test Conditions	Min	Typ	Max	Units
Channel Resistance	$R_{CH}$	Pins 1-10, 2-9, 4-7 and 5-6		8.0		$\Omega$
Total Channel Capacitance	$C_{TOTAL}$	$V_{IO} = 1.65V_{DC}$ Reverse Bias; $f=1MHz, 30mV_{AC}$		0.8	1.3	pF
Reverse Standoff Voltage	$V_{RWM}$				5.0	V
Breakdown Voltage	$V_{BR}$	$I_T=1mA$	6.0	8.0	10.0	V
Forward Voltage at $I_F$	$V_F$	$I_F=1mA$	0.4	0.7	1.5	V
Reverse Leakage Current	$I_{LEAK}$	$V_{IO} = 3.3V$		0.01	0.10	$\mu A$
Dynamic Resistance <sup>2 3</sup>	$R_{DYN}$	Positive ( $tp=8/20\mu s$ )		1.3		$\Omega$
		Negative ( $tp=8/20\mu s$ )		0.7		
		TLP, $tp=100ns$ , I/O to GND		0.36		
ESD Withstand Voltage <sup>1 2</sup>	$V_{ESD}$	IEC61000-4-2 (Contact Discharge)	$\pm 15$			kV
		IEC61000-4-2 (Air Discharge)	$\pm 30$			kV
Differential Mode Cutoff Frequency <sup>2</sup>	$F_{3dB}$	$Z_{SOURCE} = 50 \Omega, Z_{LOAD} 50 \Omega$		2.5		GHz
Common Mode Stop Band Attenuation <sup>2</sup>	$F_{\alpha}$	$f=800MHz$		30		dB

Notes: <sup>1</sup> ESD zapping at I/O pins (1,2,4,5) with respect to GND.

<sup>2</sup> Guaranteed by design.

<sup>3</sup> Transmission Line Pulse (TLP) with 100ns width and 200ps rise time.

**Differential Mode Attenuation SDD21 vs. Frequency (Zdiff = 100Ω)**

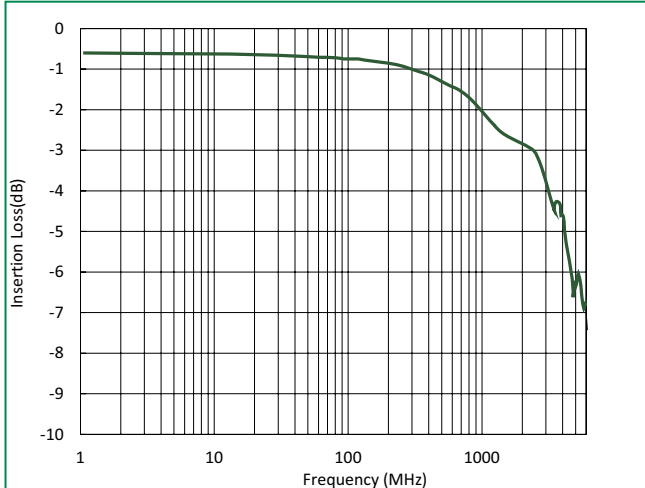

**Common Mode Attenuation SCC21 vs. Frequency (Zcomm= 50Ω)**

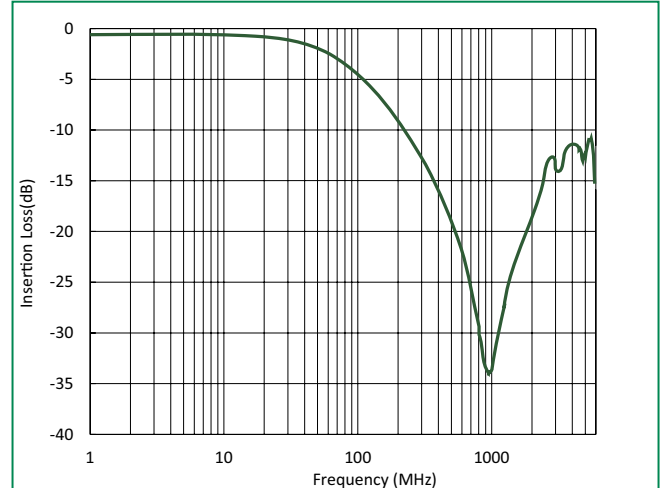

**Differential Return Loss SDD11 vs. Frequency (Zdiff = 100Ω)**

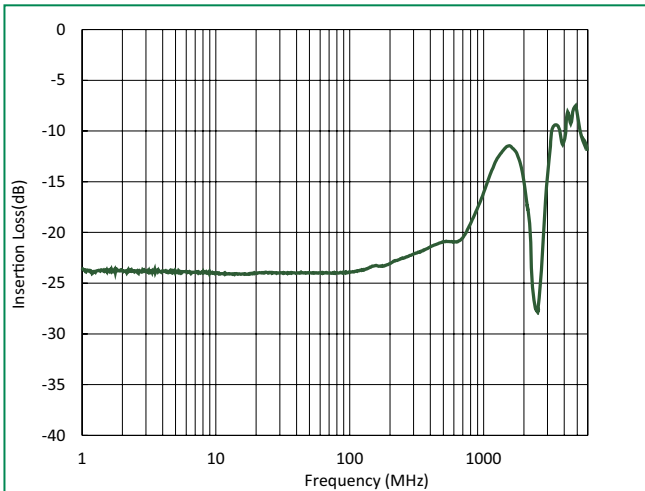

**Differential Return Loss SDD22 vs. Frequency (Zdiff = 100Ω)**

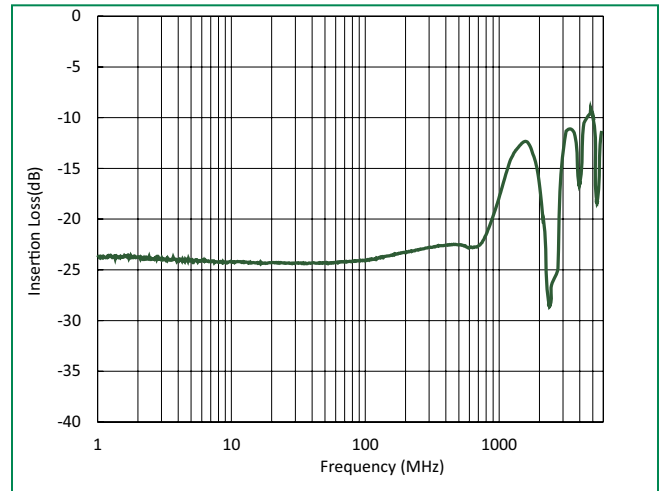

**Transmission Line Pulsing (TLP) Plot**

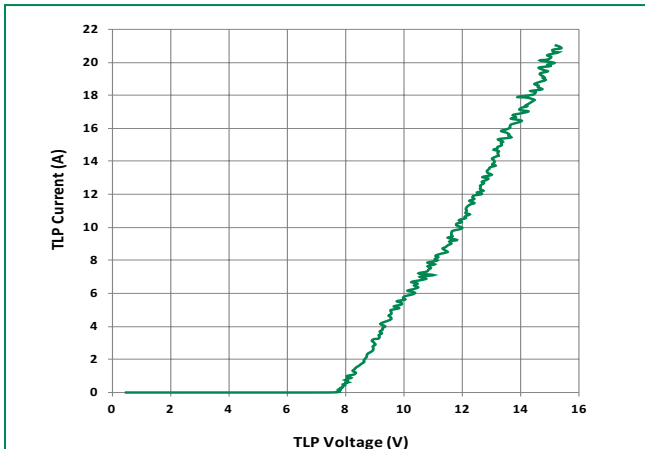

**Product Characteristics**

<b>Lead Plating</b>	Pre-Plated Frame
<b>Lead Material</b>	Copper Alloy
<b>Lead Coplanarity</b>	0.0004 inches (0.102mm)
<b>Substrate material</b>	Silicon
<b>Body Material</b>	Molded Epoxy
<b>Flammability</b>	UL 94 V-0

Notes :

1. All dimensions are in millimeters
2. Dimensions include solder plating.
3. Dimensions are exclusive of mold flash & metal burr.
4. Bld is facing up for mold and facing down for trim/form, i.e. reverse trim/form.
5. Package surface matte finish VDI 11-13.

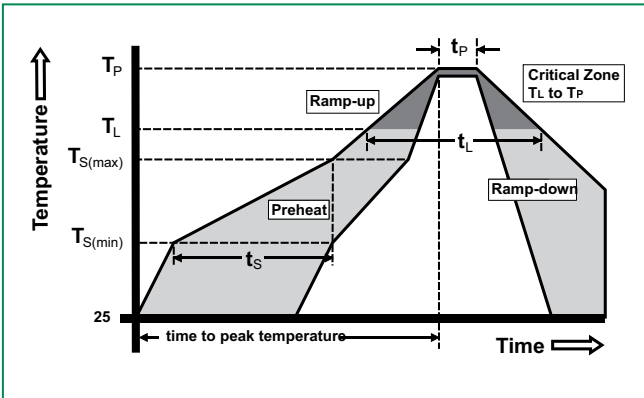

**Soldering Parameters**

Reflow Condition	Pb – Free assembly	
Pre Heat	- Temperature Min ( $T_{s(min)}$ )	150°C
	- Temperature Max ( $T_{s(max)}$ )	200°C
	- Time (min to max) ( $t_s$ )	60 – 180 secs
Average ramp up rate (Liquidus) Temp ( $T_L$ ) to peak	3°C/second max	
$T_{S(max)}$ to $T_L$ - Ramp-up Rate	3°C/second max	
Reflow	- Temperature ( $T_L$ ) (Liquidus)	217°C
	- Temperature ( $t_L$ )	60 – 150 seconds
Peak Temperature ( $T_P$ )	260 <sup>+0/-5</sup> °C	
Time within 5°C of actual peak Temperature ( $t_p$ )	20 – 40 seconds	
Ramp-down Rate	6°C/second max	
Time 25°C to peak Temperature ( $T_P$ )	8 minutes Max.	
Do not exceed	260°C	

**Part Numbering System**

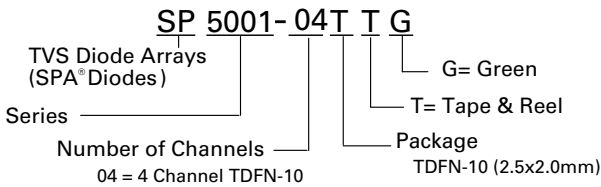

**Part Marking System**

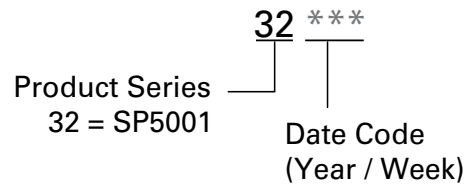

**Ordering Information**

Part Number	Package	Size	Marking	Min. Order Qty.
SP5001-04TTG	TDFN-10	2.5x2.0mm	32****	3000

**Package Dimensions –TDFN-10**

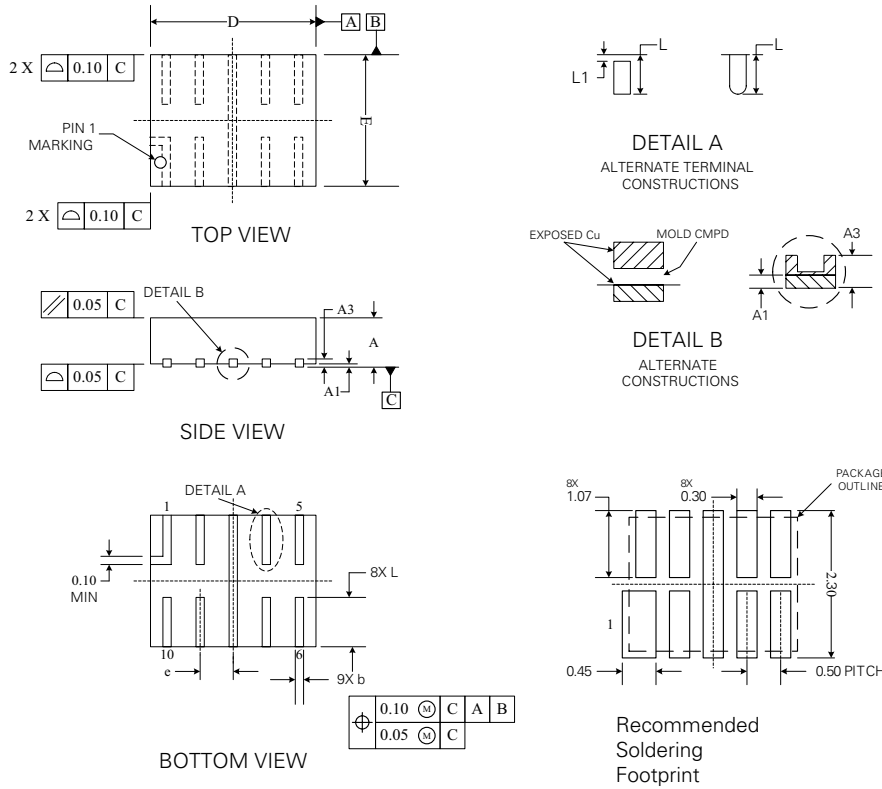

**Tape & Reel Specification –TDFN-10**

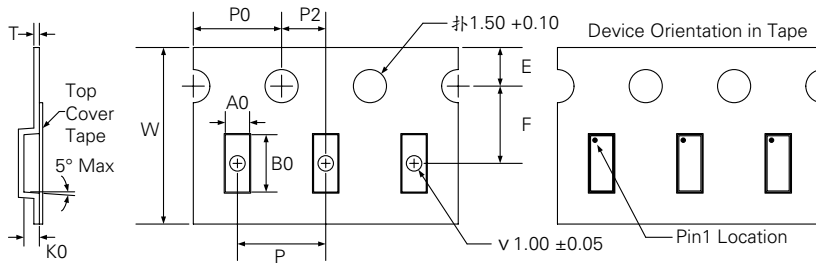

Symbol	Dimensions	
	Millimetres	
<b>E</b>	1.75+/- 0.10	
<b>F</b>	3.5 +/- 0.05	
<b>P</b>	4.0 +/- 0.10	
<b>P0</b>	4.0 +/- 0.10	
<b>P2</b>	2.0 +/- 0.05	
<b>W</b>	8.00 +0.30/- 0.10	
<b>A0</b>	2.19 +/- 0.05	
<b>B0</b>	2.77 +/- 0.05	
<b>K0</b>	1.05 +/- 0.05	
<b>T</b>	0.25+/- 0.02	