

**40**mm sq.

# San Ace 40

10mm thick (9P type), 15mm thick (9GA type),  
 15mm thick (9P type), 20mm thick (9GA type),  
**20mm thick (9P type)**, 28mm thick (9GA type),  
 28mm thick (9GE type), 28mm thick (9GV type),  
 28mm thick (9P type)



## General Specifications

- Material ..... Frame: Plastics (Flammability: UL94V-0),  
 Impeller: Plastics (Flammability: UL94V-1)
- Expected Life ..... Refer to specifications (L10:Survival rate:90% at 60°C ,  
 rated voltage, and continuously run in a free air state)
- Lead Wire ..... ⊕red ⊖black or blue (Sensor) yellow
- Storage Temperature ..... -30°C to +70°C (Non-condensing)

**40×40×20**mm (Mass : 45g) **9P type**

## Specifications

The following nos. **have pulse sensors and ribs.**

Model No.	Rated Voltage [V]	Operating Voltage Range [V]	Rated Current [A]	Rated Input [W]	Rated Speed [min <sup>-1</sup> ]	Max. Airflow [m <sup>3</sup> /min] [CFM]	Max. Static Pressure [Pa] [inchH <sub>2</sub> O]	SPL [dB(A)]	Operating Temperature [°C]	Expected Life [h]
<b>109P0405J601</b>	5	4.5 to 5.5	0.46	2.3	9,800	0.28 9.9	98.5 0.396	39	-20 to +70	40,000
<b>109P0405H601</b>			0.32	1.6	8,000	0.225 8.0	65.7 0.264	33		
<b>109P0405F601</b>			0.25	1.25	6,500	0.183 6.5	45.1 0.181	28		60,000
<b>109P0405M601</b>			0.12	0.60	5,000	0.136 4.8	26.5 0.106	24		
<b>109P0412G601</b>	12	7 to 13.8	0.28	3.36	12,500	0.35 12.4	153.8 0.618	44	-20 to +60	40,000
<b>109P0412D601</b>			0.18	2.16	11,000	0.31 10.9	124 0.498	42		
<b>109P0412E601</b>			0.15	1.8	9,200	0.26 9.2	87.3 0.351	37	-20 to +70	60,000
<b>109P0412H601</b>			0.11	1.32	8,000	0.225 8.0	65.7 0.264	33		
<b>109P0412F601</b>			0.09	1.08	6,500	0.183 6.5	45.1 0.181	28		
<b>109P0412M601</b>			0.06	0.72	5,000	0.136 4.8	26.5 0.106	24		
<b>109P0424G601</b>	24	12 to 27.6	0.15	3.6	12,500	0.35 12.4	153.8 0.618	44	-20 to +60	40,000
<b>109P0424D601</b>		12 to 27.6	0.13	3.12	11,000	0.31 10.9	124 0.498	42		
<b>109P0424H601</b>		12 to 27.6	0.07	1.68	8,300	0.233 8.2	69.6 0.280	35	-20 to +70	60,000
<b>109P0424F601</b>		14 to 27.6	0.06	1.44	6,500	0.183 6.5	45.1 0.181	28		
<b>109P0424B601</b>		20.4 to 27.6	0.06	1.44	5,200	0.14 4.9	28.3 0.114	25		

Some models can also be equipped without sensors or with PWM control functions as an option. Please refer to the index (pp. 417 to 437).

## Dimensions (unit : mm)

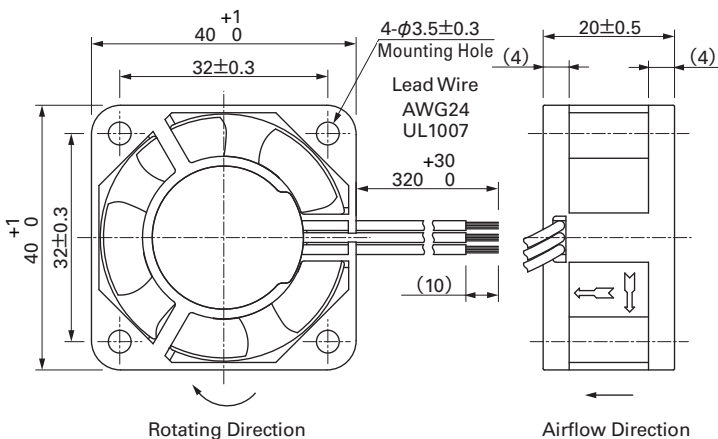

■ Reference Dimension of Mounting Holes and Vent Opening (unit : mm)

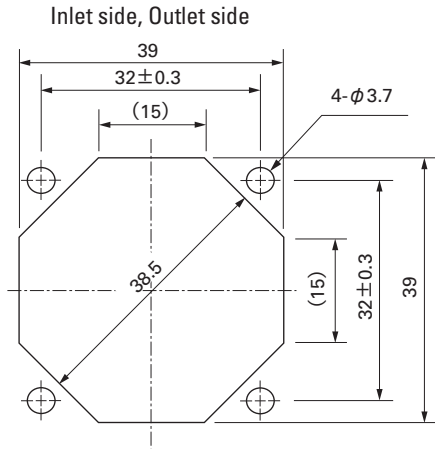

■ Options (unit : mm)

Finger Guards

Model : 109-059 Surface treatment : Nickel-chrome plating (silver) Color : Silver  
: 109-059H : Cation electropainting (black) Color : Black

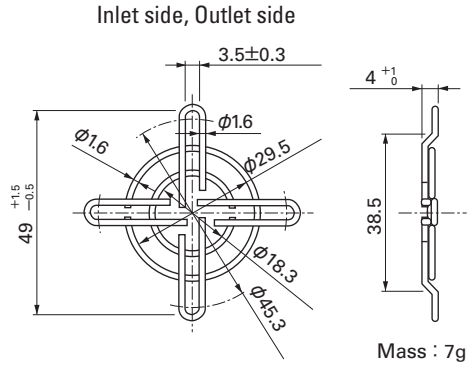

**40**mm sq.

**San Ace 40**

**40×40×20**mm [Mass : 45g]

**Airflow - Static Pressure Characteristics**

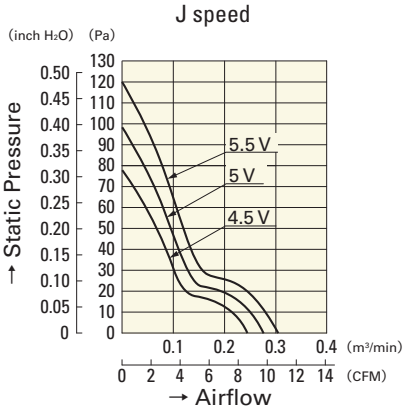

**109P0405J601**

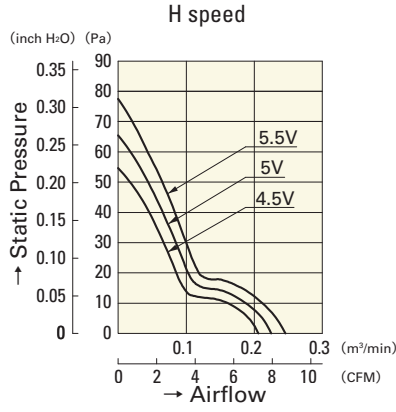

**109P0405H601**

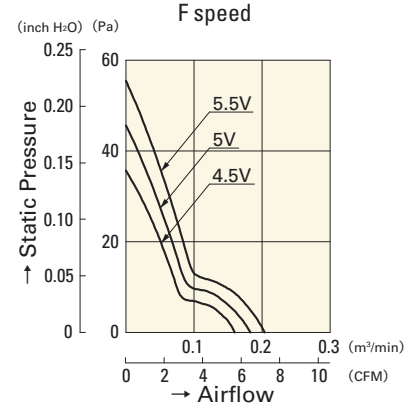

**109P0405F601**

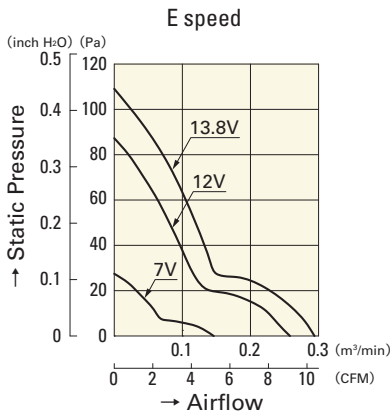

**109P0412E601**

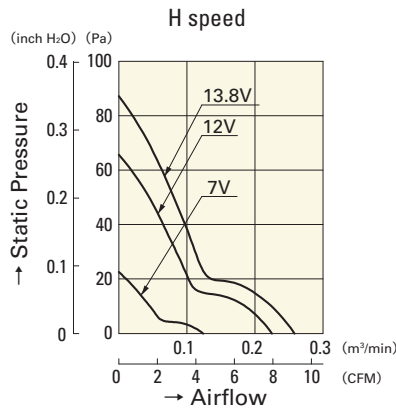

**109P0412H601**

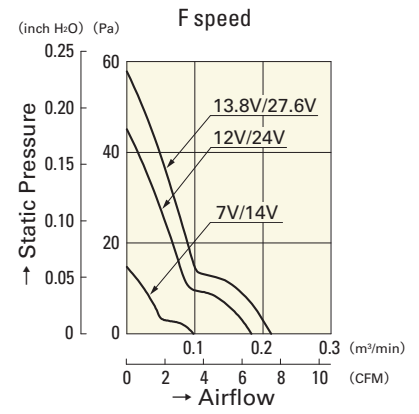

**109P0412F601**

**109P0424F601**

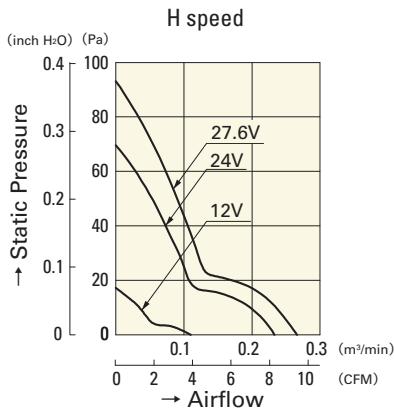

**109P0424H601**

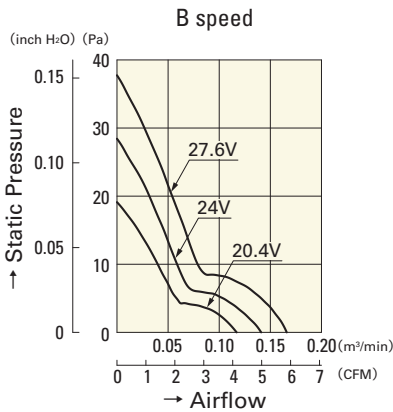

**109P0424B601**

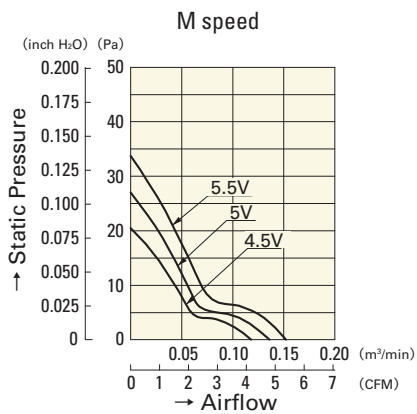

**109P0405M601**

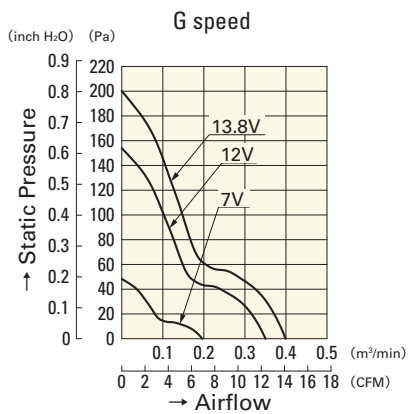

**109P0412G601**

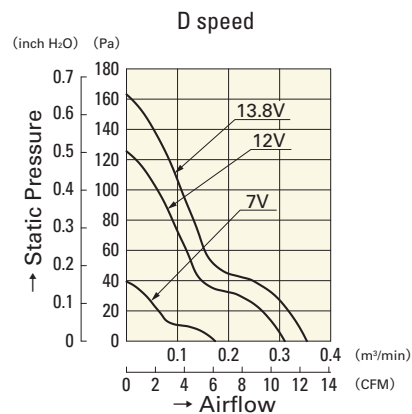

**109P0412D601**

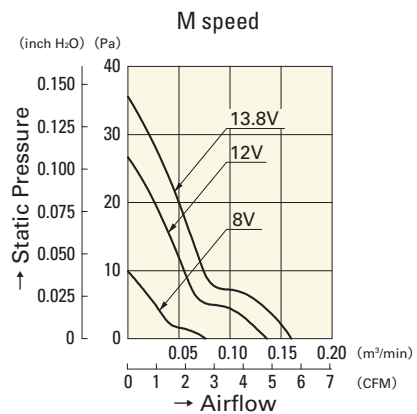

**109P0412M601**

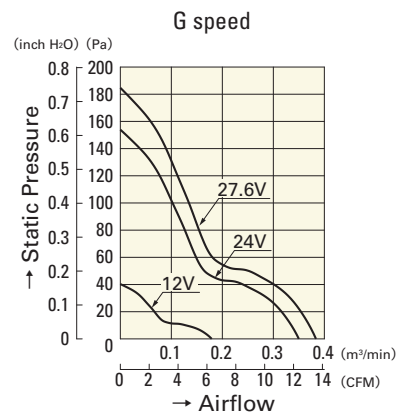

**109P0424G601**

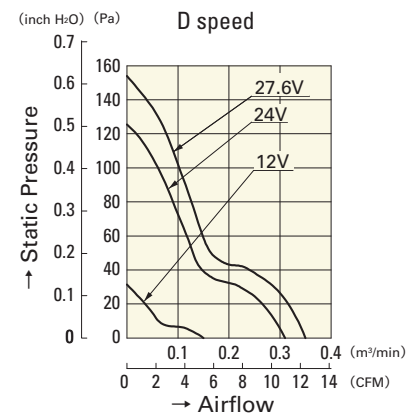

**109P0424D601**