

572-4862 Insulated solder terminal, Slotted

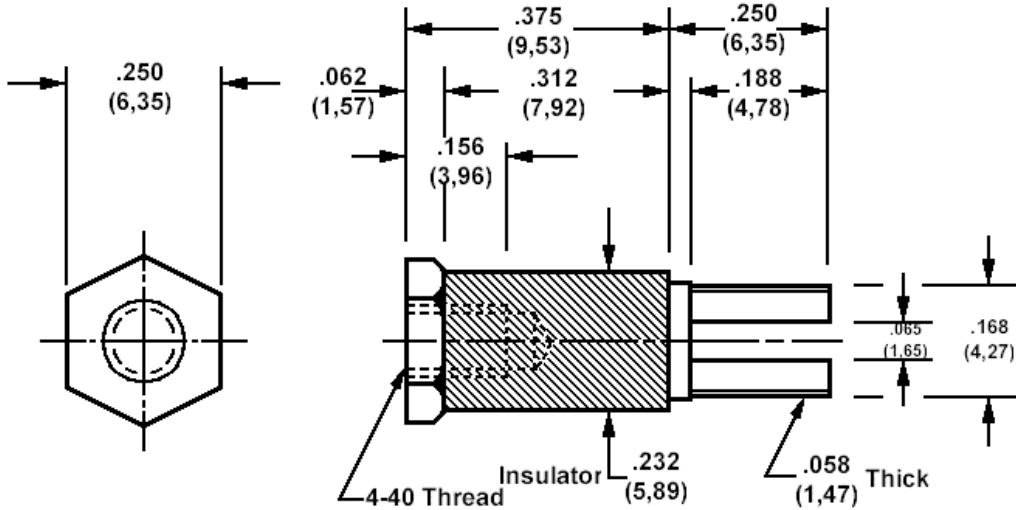

How to order code

572-4862-01-YY-16

Basic Part No (YY = plating finish. See tables for options)

Component	Material	Finish (YY)	
		-01	-05
Terminal	Brass	Silver	Electro Solder
Stud	Brass	Cadmium (plus chromate)	Cadmium (plus chromate)
Insulator	Diallyl Phthalate (blue)		

Additional Specifications	
Dielectric Withstanding Voltage (VRMS)	6000