

NT20S

Programmable Terminal

Operation Manual

Cat. No. V020-E3-2

OMRON Product References

All OMRON products are capitalized in this manual. The word "Unit" is also capitalized when it refers to an OMRON product, regardless of whether or not it appears in the proper name of the product.

The abbreviation "Ch," which appears in some displays and on some OMRON products, often means "word" and is abbreviated "Wd" in documentation in this sense.

The abbreviation "PC" means Programmable Controller and is not used as an abbreviation for anything else.

The abbreviation "Host" means PC that controls NT20S.

Visual Aids

The following headings appear in the left column of the manual to help you locate different types of information.

- | | |
|-------------------|---|
| Note | Indicates information of particular interest for efficient and convenient operation of the product. |
| 1, 2, 3... | 1. Indicates lists of one sort or another, such as procedures, checklists, etc. |

© OMRON, 1997, 1998

All rights reserved. No part of this publication may be reproduced, stored in a retrieval system, or transmitted, in any form, or by any means, mechanical, electronic, photocopying, recording, or otherwise, without the prior written permission of OMRON.

No patent liability is assumed with respect to the use of the information contained herein. Moreover, because OMRON is constantly striving to improve its high-quality products, the information contained in this manual is subject to change without notice. Every precaution has been taken in the preparation of this manual. Nevertheless, OMRON assumes no responsibility for errors or omissions. Neither is any liability assumed for damages resulting from the use of the information contained in this publication.

TABLE OF CONTENTS

PRECAUTIONS	xiii
1 Intended Audience	xiv
2 General Precautions	xiv
3 Safety Precautions	xiv
SECTION 1	
Functions of the NT20S	1
1-1 Role and Operation of NT20S	2
1-2 Functions of NT20S	4
1-3 System Configuration	10
1-4 Direct Connection Function	12
1-5 Communications with PC by Direct Connection	15
1-6 Communications by RS-232C	18
1-7 Before Operating	19
SECTION 2	
Hardware Settings and Connections	21
2-1 Description of Parts and Settings	22
2-2 Installation	27
2-3 Connecting to the Support Tool	31
2-4 Connection to a PC by the Host Link	32
2-5 Connection to a PC by the NT Link	45
2-6 Connection to a PC by the NT Link (1:N)	49
2-7 Communicating with the PC Using C200H Direct Communication	58
2-8 Host Connections by RS-232C	63
SECTION 3	
System Menu Operation	65
3-1 Operation Flow by the System Menu	66
3-2 Starting the NT20S	67
3-3 Operation Modes and the System Menu	68
3-4 Initializing Memory	72
3-5 Setting the Conditions of Communications with the Host by Using the Memory Switches	75
3-6 Registering the Screen Data	86
3-7 Starting the Operation	90
3-8 Various System Settings	91
3-9 System Maintenance	99

SECTION 4		
NT20S Functions and Operation		111
4-1	Creating and Transmitting Screen Data	112
4-2	Outline of Functions	118
4-3	Screen Display	122
4-4	Memory Tables	126
4-5	Bar Graphs	129
4-6	Lamps	133
4-7	Touch Switches	136
4-8	Numeral Setting	140
SECTION 5		
How to Use the Host Link/NT Link		151
5-1	Overview of Direct Connection Operations	152
5-2	Memory Tables and Bar Graphs	163
5-3	Lamps, Touch Switches, Numeral Setting	178
5-4	NT20S Status Control	191
5-5	Notification of the Operating Status to the PC (Determining the NT20S Operating Status)	196
SECTION 6		
Using the RS-232C		199
	Table of Commands	200
6-1	RS-232C Communications	201
6-2	Screen Display	204
6-3	Memory Tables	205
6-4	Lamps, Touch Switches, Numeral Setting	208
6-5	Controlling the NT20S Status	214
6-6	Terminal Commands	216
6-7	Key to Programs	222
	EXAMPLE PROGRAM	223
SECTION 7		
Troubleshooting and Maintenance		235
7-1	Hardware Faults	236
7-2	Responding to Displayed Error Messages	237
7-3	Maintenance of the NT20S	239
7-4	Inspection and Cleaning	241

APPENDICES	243
A. Specifications	243
B. Dimensions	248
C. Handling the RS-232C/RS-422A Converter Unit	249
D. NT20S Installation Environment	251
E. NT20S Internal Processing	252
F. Function Restrictions Depending on the Support Tool	255
G. Method for Making the Cable for Connection to the Host	256
H. Making the Cable for Connection to the Support Tool	268
I. Connecting to an RS-232C/RS-422A Converter Unit (1:1)	269
J. Model List	271
K. Option List	276
L. PC Memory Map	278
M. Special Characters	279
INDEX	281

About this Manual:

This manual describes the basic functions and operation procedures of the NT-series programmable terminal NT20S, its operations when connected to a PC or a Host, and includes the sections described below.

Please read this manual carefully and be sure you understand the information provided before attempting to install and operate the NT-series programmable terminal NT20S.

WARNING Failure to read and understand the information provided in this manual may result in personal injury or death, damage to the product, or product failure. Please read each section in its entirety and be sure you understand the information provided in the section and related sections before attempting any of the procedures or operations given.

Section 1 describes the operation functions, system configuration, and the direct connection function of the NT20S.

Section 2 describes the NT20S hardware settings, its installation in an operation panel, its connection to the Host, etc.

Section 3 describes the procedure before operating the NT20S, and useful functions when operating it. Also describes how to perform an operation check.

Section 4 describes the functions of the NT20S when it is connected to a Host.

Section 5 describes how to operate the NT20S when the host link/NT link is used for communication. Read this chapter only when using the NT20S-ST121□/ST161□/ST122□.

Section 6 describes how to operate the NT20S when the RS-232C interface is used for communication. Read this chapter only when using the NT20S-ST128□/ST168.

Section 7 describes the procedures to follow when the system does not operate correctly, and the procedure for routine maintenance of the NT20S.

APPENDIX describes the specifications and the method for making connecting cables, and includes an area list for the PC.

Related Manuals and Their Contents:

The related manuals are indicated below.

The □ symbol at the end of the manual number is the revision history symbol.

[Operating the programmable terminal and communicating with the host]

- NT20S Programmable Terminal Operation Manual (V020-E1-□)
..... This manual

This operation manual is the manual for the NT20S itself.

The NT20S is a unit which integrates a programmable terminal body and host interface unit. This operation manual describes the functions and handling of both the programmable terminal body and the host interface function.

[Creating and transferring screen data]

- NT Series Support Tool Ver.2□ Operation Manual (V028-E1-□)

The screens displayed on the NT20S are created with the support tool and transferred to the NT20S. This manual describes how to create and transfer screen data.

[For Connection to Other Makers' PCs]

- PC Connection V042-E1-□

NT600S-ST121(B)-EV3 and NT600S-ST211(B)-EV3 can be connected to Mitsubishi A series PCs. This manual describes how to make the connection and how to make settings when connecting the PT to a Mitsubishi A series PC.

In order to use the PT while connected to a PC made by a manufacturer other than OMRON, the Ver. 2.3 support tool must be used.

PRECAUTIONS

This section provides general precautions for using the Programmable Terminal.

The information contained in this section is important for the safe and reliable application of the Programmable Terminal. You must read this section and understand the information contained before attempting to set up or operate a Programmable Terminal.

1 Intended Audience	xiv
2 General Precautions	xiv
3 Safety Precautions	xiv

1 Intended Audience

This manual is intended for the following personnel, who must also have knowledge of electrical systems (an electrical engineer or the equivalent).

- Personnel in charge of installing FA systems.
- Personnel in charge of designing FA systems.
- Personnel in charge of managing FA systems and facilities.

2 General Precautions

The user must operate the product according to the performance specifications described in the operation manuals.

Before using the product under conditions which are not described in the manual or applying the product to nuclear control systems, railroad systems, aviation systems, vehicles, combustion systems, medical equipment, amusement machines, safety equipment, and other systems, machines, and equipment that may have a serious influence on lives and property if used improperly, consult your OMRON representative.

Make sure that the ratings and performance characteristics of the product are sufficient for the systems, machines, and equipment, and be sure to provide the systems, machines, and equipment with double safety mechanisms.

This manual provides information for using the Programmable Terminal. Be sure to read this manual before attempting to use the software and keep this manual close at hand for reference during operation.

 **WARNING** It is extremely important that Programmable Terminals and related devices be used for the specified purpose and under the specified conditions, especially in applications that can directly or indirectly affect human life. You must consult with your OMRON representative before applying Programmable Terminals to the abovementioned applications.

 **WARNING** Do not use input functions such as PT touch switches for applications where danger to human life or serious damage is possible, or for emergency switch applications.

3 Safety Precautions

Read these safety precautions carefully and make sure you understand them before using the Programmable Terminal so that you can use it safely and correctly.

Safety Conventions and their Meanings

This operation manual uses the following conventions and symbols to indicate cautions, warnings, and dangers in order to ensure safe use of the PT. The cautions, warnings, and dangers shown here contain important information related to safety. The instructions in these cautions, warnings, and dangers must be observed.

The conventions used and their meanings are presented below.

 **DANGER!** Indicates information that, if not heeded, is likely to result in loss of life or serious injury.

 **WARNING** Indicates information that, if not heeded, could possibly result in loss of life or serious injury.

 **CAUTION** Indicates information that, if not heeded, could result in relatively serious or minor injury, damage to the product, or faulty operation.

⚠ WARNING: Do not attempt to take the PC apart and do not touch any internal parts while the power is being supplied. Doing either of these may result in electrical shock.

Turn off the power before replacing the backlight. Otherwise you could sustain an electric shock.

⚠ CAUTION: If the DIP switch settings have been changed when the NT20S is powered, reset the power to the NT20S. The changes with the DIP switches become effective only after the power supply is reset.

With systems in which the user program operates in accordance with the PC cycle time, since there is some fluctuation in the PC cycle time, the system operation may not be consistent, and this should be born in mind when designing the system.

- When making the connection, switch off the power to the NT20S and PC before disconnecting or connecting any connector.

When screen data transmission is in screen units, if there is data other than screen data, for example memory table or direct access changes, transmit this data also.

- Do not use input functions such as PT touch switches for applications where danger to human life or serious property damage is possible or for emergency switch applications.

During work at the panel, take care to ensure that no metal scraps enter the unit. Otherwise, the product may malfunction.

For the connection to the power supply terminal block, twisted wires of 2 mm² or greater cross sectional area and M3.5 size crimp terminals must be used. Tighten the screws on the terminal block to a torque of 0.8N·m. Otherwise fire may occur.

- After connecting the communication cable, always secure it with the screws. Otherwise the cable may disconnect, causing operation to fail.
- The cable's tensile load is 30 N. Do not subject it to loads greater than this. Otherwise a discontinuity may occur, causing operation to fail.

Do not install the NT20S at sites subject to the following conditions. Otherwise, the product may malfunction.

- Severe temperature variations
- Temperatures or humidities outside the ranges stated in the specifications
- High humidity, condensation
- Splashing chemical agents
- Severe oil splashing
- Corrosive or flammable gases
- Strong vibrations or shocks

- Direct exposure to wind and rain (outdoor sites)
- Strong ultra-violet irradiation

Take adequate measures to ensure shielding if the NT20S is used at a location subject to any of the following conditions.

- Static electricity, or noise from other equipment
- Strong electric or magnetic fields
- Nearby power cables
- Potential exposure to radioactivity
- Do not install at a site exposed to chemicals, steam, etc, or subject to excessive airborne dust.
- Do not install the unit at locations where the ambient temperature goes outside the range 0 to 50° C or where the relative humidity goes outside the range 35 to 85% RH.
If the ambient temperature exceeds the range indicated above, install a fan or an air conditioner.
- Do not install the unit directly above equipment that generates a lot of heat (heaters, transformers, large capacity resistors, etc.)
- Take the following points into account in order to prevent noise
 - (1) Avoid installing the unit in panels in which high-voltage equipment is also installed.
 - (2) Install the unit at a distance of at least 200 mm from power lines.
 - (3) If the unit is installed next to equipment that generates a strong electric or magnetic field (solenoids, etc.), provide a gap of at least 40 mm.
- Secure sufficient space for ventilation.
- Do not install in sites subject to severe vibration or strong shocks.
- Install at a distance from high-voltage devices and power equipment in consideration of operability and safety during maintenance.
- Press touch switches with a force of no greater than 30 N.
- If touch switches are pressed in rapid succession, their inputs may not be successfully received.
Confirm that the input of a touch switch has been successfully received before moving on to the next operation.
- Do not press touch switches carelessly while the backlight is off or while nothing is displayed on the screen. Otherwise the system may operate unpredictably.
Only press touch switches after confirming system safety.

Confirm system safety carefully before changing monitor data.

To ensure system safety, be sure to periodically read the PT operating status bit from the host in order to ensure that the PT is always operating normally.

- Always turn off the power at the PC and PT before connecting the C200H interface cable. Otherwise the system may operate unpredictably.

If the actual character string is longer than the specified character string length, the specified number of characters is written and the remainder are discarded. A timeout error message is displayed if the actual character string is shorter than the specified character string length.

This command cannot be used to write negative numbers. Use the 8-digit Write Command (refer to *6-3 8-digit Write Numeral Memory Table*).

The display attributes set with the Support Tool determine if lamps #0 to #31 light continuously or flash. The display status set with this command is ignored.

This command cannot be used for negative numbers. Always set "8" as the number of transferred digits when negative numbers may be input.

SECTION 1

Functions of the NT20S

NT20S is a new programmable terminal (PT) which incorporates a host interface unit and a RS-232C interface unit in a programmable terminal body. It can be easily installed and used.

This section gives the operation examples and characteristics of the NT20S so that you will understand the applications of the NT20S.

1-1	Role and Operation of NT20S	2
1-1-1	Operations of NT20S	3
1-2	Functions of NT20S	4
1-2-1	Features	4
1-2-2	Principal Functions of NT20S	6
1-2-3	Comparison between NT20S and NT20M	7
1-2-4	Differences Between the NT20S-ST121-EV3 and NT20S-ST122-V1	8
1-2-5	Displays	9
1-3	System Configuration	10
1-3-1	Host Link/NT Link (1:1)/C200H direct Systems	10
1-3-2	NT Link (1:N) System	11
1-4	Direct Connection Function	12
1-4-1	NT Link	13
1-4-2	C200H Direct Communication	14
1-5	Communications with PC by Direct Connection	15
1-5-1	Functions of the Allocated Bits and Words	15
1-6	Communications by RS-232C	18
1-7	Before Operating	19

1-1 Role and Operation of NT20S

NT20S is a programmable terminal used to display and transmit the information in an FA site. The following gives a general description of the role and operation of the NT20S for those who use a programmable terminal (PT) for the first time.

Production Line Status Monitoring

The NT20S displays real-time information about the system and equipment operating status, etc.

Production Control		1994/1/25
Product	NT20M	NT600M
Today's target	560 units	441 units
Current Production	305 units	275 units
% achieved	54.5 %	63.0 %

Messages

The NT20S warns of system or equipment failures and prompts the appropriate remedial action.

Alarm

Assembly line B
–
Positioning pin

is defective.

Panel Switch Functions

Setting touch switches on the NT20S allows workers to use the NT20S as an operating panel. Production data input to the NT20S or the Host can be transmitted to a PC.

Electroplating Control

Transport

↑

←

→

↓

Clamp

UnClamp

1-1-1 Operations of NT20S

Displays Screens

The information to be displayed (screen data) can be created on a computer by using support tools and stored in the NT20S. The screen data can be displayed on the NT20S in response to the instructions from a Host or touch switch operation.

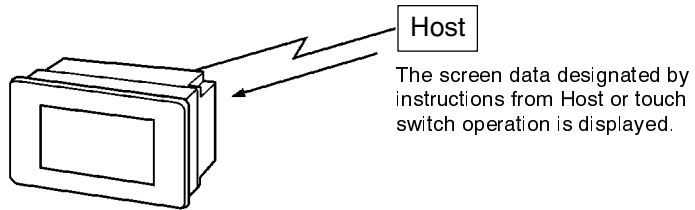

Receives Data from a Host

The NT20S can be connected to the Host using the host link or NT link communication method, or by using the RS-232C interface or C200H direct communication to enable reception of the required data from the Host.

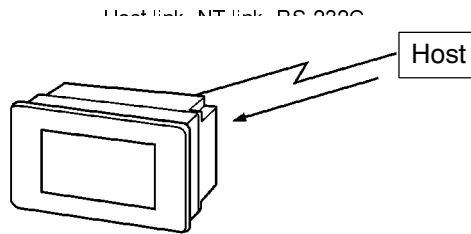

Sends Data to a Host

Data input through a touch panel can be sent to a Host.

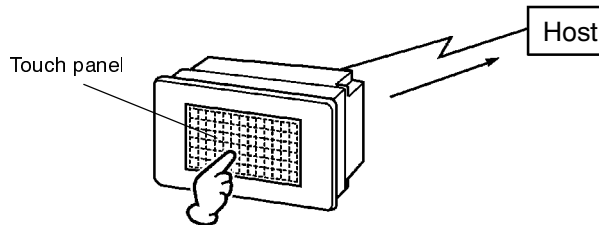

Screen Data

The screen data to be displayed on the NT20S can be created by a computer by using support tools. Connect the NT20S to a PC/AT with an RS-232C cable so that the screen data are transferred to the NT20S.

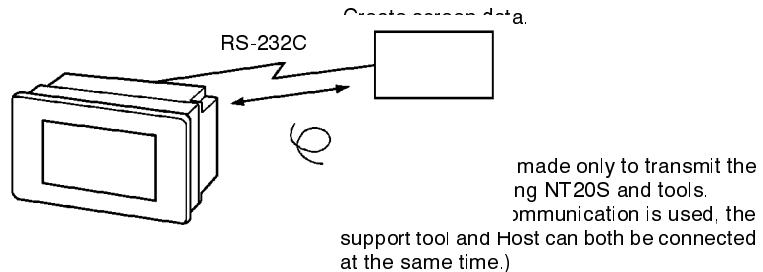

1-2 Functions of NT20S

The NT20S has the following features which are different from those of existing NT20M;

1-2-1 Features

Downsized Body

- The NT20S has the thinnest depth (54 mm or less in the panel) in the NT series.
- The width is shorter by 30 mm, maintaining the existing display area.
- The system keys and tool connectors are located at other than the front side.
- The communication cable connectors are housed in the unit so that they do not protrude from the unit.
- The tool connectors and the Host communication connectors are used in common (when the host link/NT link or RS-232C is used).

Construction Best Suited to the FA Environment

- Easy-to-read screen even in direct sunlight.
(The monochrome mode liquid crystal display of ST16□ models is even easier to read.)
- The angle of visibility is equal to that of NT20M-DT131.
- Its backlight unit can be replaced at the operation site.
- Conforms to IP65 waterproof requirements.

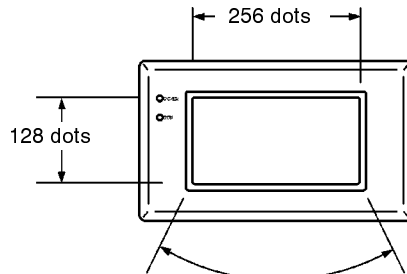

A Host Link I/F Unit, Screen Data Memory, and a System ROM are All Incorporated

- With the NT link communication method, 1:1 and 1:N connections are possible.
- There is no complicated installation work except a simple connection to a Host.
- A flash memory is used for the screen data memory. There is no need of backup battery.
- The following communication systems are standard for each model:
 - NT20S-ST121-EV3/ST161-EV3 : Host link (direct) and NT link
 - NT20S-ST122-V1 : C200H direct communication
 - NT20S-ST128/ST168 : RS-232C communication (command control)
- NT20S-ST121-EV3/ST161-EV3 can be connected to Mitsubishi FX series and Mitsubishi A series PCs.
(Refer to "PC Connection, Operation Manual" V042-E1-□.)

- Touch Switch Operation** The System Menu can be displayed by using the touch switches located in four corners of the screen.
- Compatibility with NT20M** Existing screen data, user programs, are compatible.

1-2-2 Principal Functions of NT20S

Functions Related to the Data Display

- Character display
Characters of various sizes can be displayed. Characters can flash or be highlighted.
- Figure display
Straight lines, circles, and other graphic figures can be displayed.
- Memory data display
Contents of the character-string memory table and the numeral memory table can be displayed. The memory table contents can be changed from the PC/Host.
- Bar graph display
Bar graphs corresponding to the contents of the numeral memory table can be displayed.
- Lamp display
Lamps which turn on or flash as controlled by the Host can be displayed.

Functions Related to the Data Input

- Input by the touch switch
Data can be input by simply touching the screen.
- Numeric setting function
The touch keys can be assigned with numeric values so that the numeric values can be input at the operation site and sent to the PC/Host.

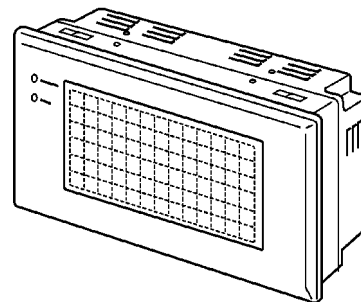

Other Functions

- Buzzer
A built-in buzzer can be used.
- Communications with a PC
By connecting the NT20S with a PC using the host link, NT link, C200H, or RS-232C communication method, data can be received from the host and touch switch status information can be sent to the host.
- System function
The system setting and maintenance can be executed by using the System Menu on the screen.
- Screen data creation
The screen data can be created by using support tools on the computer and stored in the unit.
- Unrestricted screen display
When the NT20S is connected to the host via an RS-232C interface, characters and graphics can be displayed independently of the registered screens.
(Terminal function) (NT20S-ST128/ST168)

1-2-3 Comparison between NT20S and NT20M

The NT20S is a unitary PT which incorporates a system ROM, screen memory, and a host I/F unit (Host link, NT link, RS-232C, and C200H direct communication) as the standard equipment in one body.

The NT20S has the following features which are different from those of existing NT20M;

Function	NT20S	NT20M-DT121-V2
Communication	<ul style="list-style-type: none"> • Host link/NT link incorporated NT20S-ST121-EV3 • C200H direct communication incorporated NT20S-ST122-V1 • RS-232C incorporated NT20S-ST128 (other host I/F units cannot be connected) 	Host I/F units are required.
Communication connector	<ul style="list-style-type: none"> • The communication connector (9-pin) for a Host is shared with that for a support tool. (NT20S-ST121-EV3/ST128) • Connectors for support tool (9-pin) and Host connections on the rear face (NT20S-ST122-V1). 	The support tool connector (9-pin) is located on the front side. The Host connector (25-pin) is located on the back side.
Host RUN input terminal/ Alarm output terminal	Not provided	Provided
System keys	Not provided	Provided
Contrast control	Back side	Front side
Waterproof performance	Conforms to IP65.	Conforms to IP54F.
Visibility in direct sunlight	Excellent	Average
Allowable momentary power interruption time	Not guaranteed	5 msec
System ROM	Built in (not replaceable)	System ROM compatible with host I/F unit is required.
Resume function	Not provided	Provided
History retaining function	Not provided	Provided
Screen transfer	○	○ (Only possible if screen data memory is an SRAM)
Screen data compatibility	○ (Note)	–
PC ladder compatibility	○	–
Backlight replacement	○	Possible with NT20M-DT131.
Screen data memory	Built in (flash memory only)	Optional (select from EP-ROM, SRAM, and EEP-ROM)
Screen data memory capacity	96KB	128 KB max.
Outside dimensions	190 × 110 × 58mm	220 × 110 × 82mm

Note: If a system key function is required on continuous screens or for numerical setting or buzzer stop, use a support tool and set the touch switches which have the system key function in such screens.

For details, refer to “System Key Functions” on page 139.

1-2-4 Differences Between Existing Models and NT20S-ST121-EV3

The differences between the existing NT20S-ST121, NT20S-ST121-V1/ST122-V1/ST121-V2 models for direct connection and the upgraded version NT20S-ST121-EV3 are indicated in the table below.

Item	ST121	ST121-V1/ ST122-V1	ST121-EV3
Communication type	Host link/NT link (1:1 connection) built in	ST121-V1: Host link/NT link (1:1 connection) built in ST122-V1: C200H direct communication built in	<ul style="list-style-type: none"> Host link/NT link (1:1 communication)/NT link (1:N connection) built in
“PT type” setting made with support tool	“20M”	“20S” (“20M”-compatible mode available)	
Memory capacity	64KB	96KB	
Max. number of screens	250	500	
Screen transmission speed	Standard only	Standard, high-speed	
Screen transmission unit	File units only	File units, screen units	
Direct connection version	Ver.4 only	Ver.4, Ver.5	

(*)Refer to the “PC Connection, Operation Manual” (V042-E1-□).

Differences between NT20S-ST12□ and NT20S-ST16□.

- The only way in which NT20S-ST161 differs from NT20S-ST121 is that the display is a monochrome liquid crystal display. Functionally, the NT20S-ST121 and NT20S-ST161 are absolutely identical and therefore if you are using an NT20S-ST161 please refer to the explanations for the NT20S-ST121.
- The only way in which NT20S-ST168 differs from NT20S-ST128 is that the display is a monochrome liquid crystal display. Functionally, the NT20S-ST128 and NT20S-ST168 are absolutely identical and therefore if you are using an NT20S-ST168 please refer to the explanations for the NT20S-ST128.

Difference between direct connection Ver.4 and Ver.5

Ver.5 of the direct connection function has the following additional functions in comparison with Ver.4.

- “Thumbwheel” type setting possible with the numeral setting function.
- Upper and lower limit check can be set with the numeral setting function.
- The type of operation (alternate, set, reset) can be selected for touch switch input notification.
- Indirect specification possible for numeral display and character string display functions.

1-2-5 Displays

The NT20S can display various kinds of elements such as characters, lamps, touch switches, and bar graphs on a screen. The screen data displayed on the NT20S are created by using support tools on a computer.

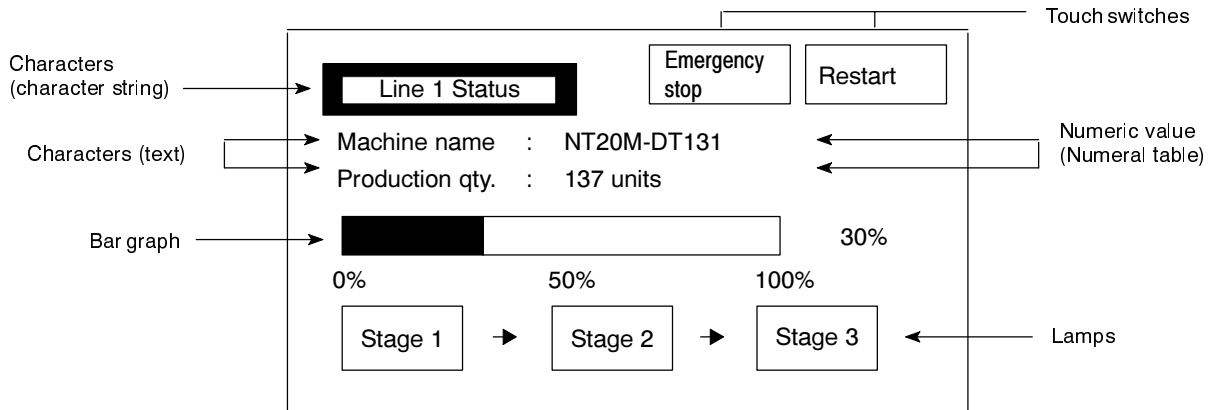

Characters (text) Characters and marks which do not need to be changed can be written directly to the screen.

Characters (character-string memory table)

Character-strings stored in the character-string memory table are displayed. The display characters can be changed by changing the data stored in the character-string memory table.

Numeric Values (numeral tables)

Numbers stored in the numeral table are displayed. The display numbers can be changed by changing the data stored in the numeral table. Hexadecimal values can also be displayed.

Lamps

Lamps are displayed as square or round frames and indicate the operating status. They are controlled by the Host and can be lit (reversed) or made flash (alternates normal with reversed displays).

Touch Switches

Touch switches can be set anywhere on the screen. Touching the screen at a touch switch location can switch the display (display switch function) or notify the Host (notification function). The touch switches can be lit or made flash by controlling from the Host in the same way as the lamps.

Numeric Keys

These are the touch switches used to input numeric values.

Bar Graphs

The bar graph extends and contracts in proportion to the data stored in the numeral table. A percentage value can also be displayed simultaneously.

Marks

Marks can be designed, created, and handled like characters by the user.

1-3 System Configuration

This section gives the basic configuration of a system which uses an NT20S. Refer to the manual for individual device for information on the equipment other than the NT20S in the system.

Reference: Refer to Section 3-5 “Setting the Conditions of Communications with the Host by Using the Memory Switches” on page 75 for the communication method and the conditions of communications between the NT20S and the Host. It is impossible to connect a computer to use a support tool and a Host together at the same time. (except when using an NT20S-ST122-V1)

The principal optional devices for NT20S are as follows;

Replacement backlight NT20S-CFL01 (one white light)

Anti-glare sheet NT20M-KBA04 (five sheets in a pack)

Chemical-resistant cover (made of silicone rubber) NT20S-KBA01

1-3-1 Host Link/NT Link (1:1)/C200H direct Systems

Host (PC manufactured by OMRON, personal computer, etc.)
Controls NT20S as required while controlling machines and monitoring the production line.

Series PC, C□□H, CQM1,
Directly to the CPU unit.
Can be used with version [-EV1]

Series a host link unit.
In this case, the NT20S can be
used as a host link unit.

Series 41/42/43/44-E,
Series U21/23/31/33-E.
Can be used with [-EV1] CPU unit and

Series

Series 3/HE, C□□H PC

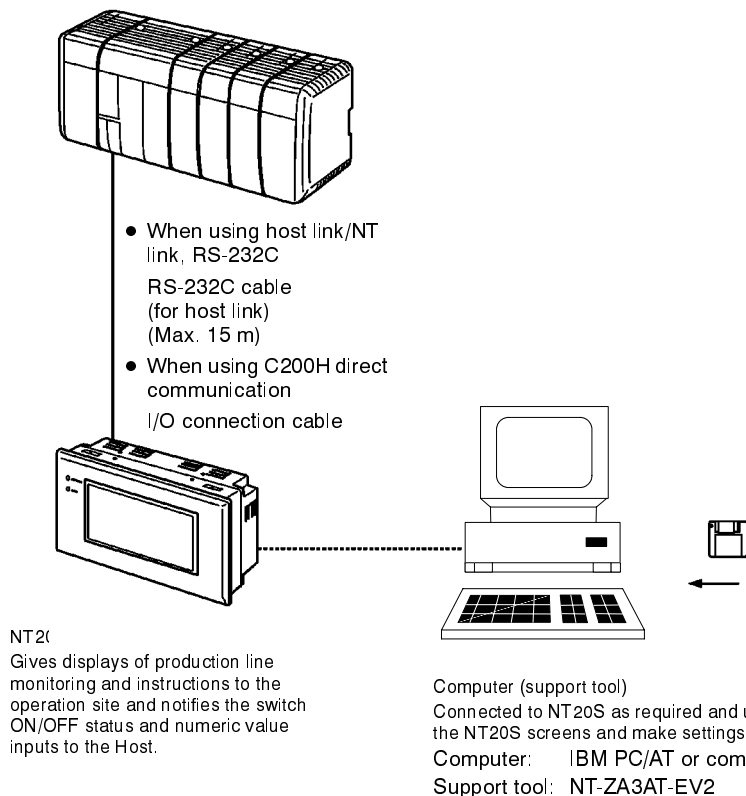

1-3-2 NT Link (1:N) Systems

When NT20S is connected to a PC in a 1:N connection, use an RS-232C cable and RS-422/485 cables.

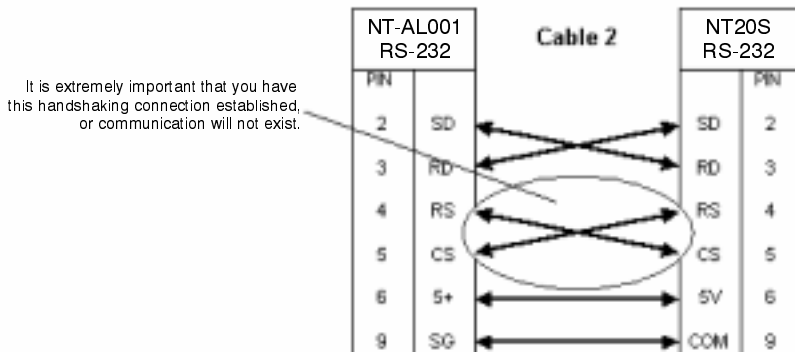
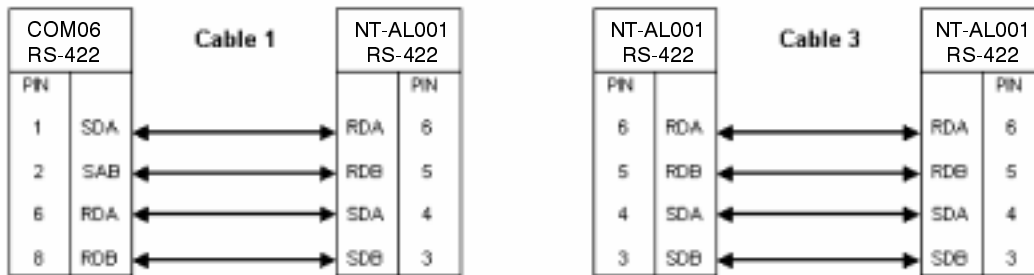
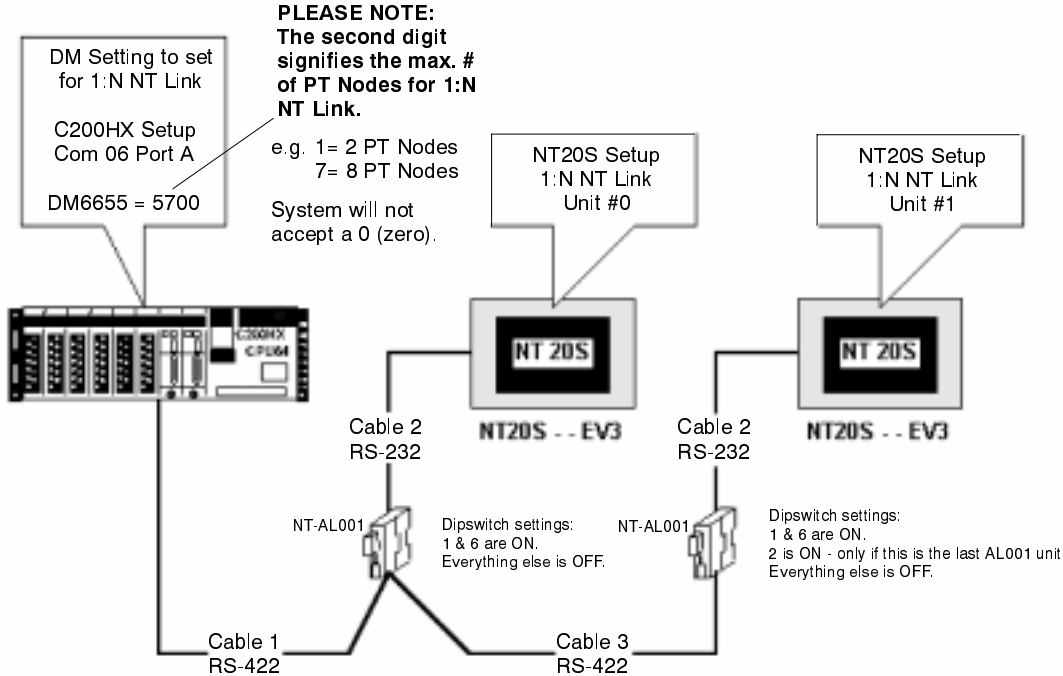

Reference: When connecting the C200HX/HG/HE and an RS-232C/RS-422 converter unit, use a converter unit whose lot number is 15Y5 or later. Converter units of lot numbers previous to 15Y5 cannot be connected.

1-4 Direct Connection Function

The communication method applied between the NT20S-ST121-EV3 and the PC is either a host link or NT link. To connect an NT20S-ST122-V1 and PC, the C200H direct communication function is used.

The following describes the “direct connection” function available with the NT20S-ST121-EV3/ST122-V1, and communication with a PC.

- ➔ The NT20S-ST128 uses an RS-232C interface for communication with the PC (refer to Section “Communications by RS-232C”).

The NT20S can be used to refer to the contents necessary for the display information or to allocate the bits and words used for storing the input data to any area in the PC. The NT20S can directly write and read such allocated bits and words so as to change the display elements, control the operating status, and notify the status.

This function is called the “direct connection function”. The NT20S-ST121-EV3/ST122-V1 is designed exclusively for use with the direct connection.

The bits and words allocated by the direct connection function are called “allocated bit” and “allocated word” respectively.

This function allows to read the information to be displayed on the NT20S from the memory area in the PC and to write it to the memory table in the NT20S. Also, the data input on the NT20S can be written to the PC’s memory area. The NT20S screen status can be switched according to the PC’s memory area, and the NT20S’s status data can be written to the PC’s memory area.

The NT20S-ST121-EV3 can only communicate with a PC that supports the host link or NT link function. The NT20S-ST122-V1 can only communicate with PCs that support the C200H direct communication function.

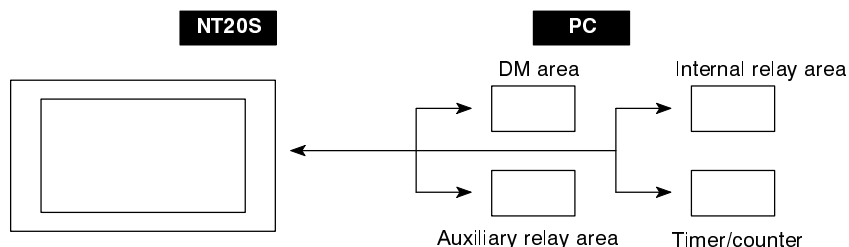

Features of the Direct Connection Function

- The bits and words referring to operating status and work instruction information and those for storing input data can be freely allocated to almost any part of the PC memory. Bits and words in the PC can be referenced from any memory table.
- The NT20S can directly refer to PC bit and word data so that it can be connected to a PC without changing the PC program which controls currently running production line.
- The area to control and notify the NT20S status, including display screens, back-lighting or a flash control, and alarms and buzzers can be freely allocated to any part of the PC memory.
- Can be used irrespective of the operating mode of the PC.

The direct connection function allows the NT20S to directly read and write almost all bits and words in the PC and to automatically change the NT20S screen display. This function can reduce the load on the PC so that the program development efficiency of the PC improves.

1-4-1 NT Link

The NT link uses the direct connection function and can execute high-speed communications with the CPU (with built-in host link) of the CPM1, CQM1, C200HS, C200HX/HG/HE, or CVM1/CV series,

When using the NT20S in an NT link, two communications modes are possible: a single NT20S can be connected to one PC (1:1 NT link), or alternatively, up to eight NT20S units can be connected to a single PC port (1:N NT link).

However, the 1:N connection NT link can be used with C200HX/HG/HE only. In the following sections, the NT link communication mode in general will be indicated by the term "NT link", a 1:1 connection NT link will be indicated by "NT link (1:1)", and a 1:N connection NT link will be indicated by "NT link (1:N)".

Features of the NT Link

- High speed communications with specific types of PCs can be executed.
- Writing in units of bits to the PC memory area is possible.

This enables another bit of a word data to which a touch switch has been allocated to be used for other purpose (e.g., to allocate a lamp).
- Can be used even while the PC is in the run mode. When using a host link, the NT20S switches from the run mode to the monitor mode.
- With NT link (1:N), up to eight NT20S units can be connected to a single PC port and used simultaneously.
- When using C200HX/HG/HE, by installing an expansion communication board in the option slot of the CPU unit, it is possible to connect up to three NT link (1:N) systems (comprising a total of 24 NT20S units). For details on communication boards, refer to the SYSMAC C200HW-COM01 to C200HW-COM06-E Communication Board OPERATION MANUAL (W304-E1-□).

The NT link is compatible with the host link. The NT20S screen data and the PC programs handled by the host link direct connection can be used with for the NT link as they are.

1-4-2 C200H Direct Communication

C200H direct communication is a communication method that uses C200H, C200HS, C200HX/HG/HE and C□□H I/O extensions.

The C200H direct communication function of the NT20S-ST122-V1 allows communication with a PC (C200H, C200HS, C200HX/HG/HE, C□□H) using the direct connection function.

Characteristics of C200H direct communication

C200H direct communication has the following characteristics.

- High-speed communication is possible through an I/O cable easily connected to the CPU unit.
- Data can be written to the PC memory area in bit units.
This means that the unused bits of words allocated to touch switches can be used for other applications (for example, lamp allocations).

Since the C200H direct communication function is compatible with the host link, the NT20S screen data and PC programs for host link direct connection can also be communicated by C200H direct communication without alteration.

 **Caution:**

With systems in which the user program operates in accordance with the PC cycle time, since there is some fluctuation in the PC cycle time, the system operation may not be consistent, and this should be born in mind when designing the system.

1-5 Communications with PC by Direct Connection

1-5-1 Functions of the Allocated Bits and Words

When using an NT20S-ST121-EV3 with the direct connection function (host link or NT link), NT20S-ST122-V1 (C200H direct communication), the elements displayed on the NT20S and the NT20S status can be allocated to the bits and words of the PC. By changing the contents of the bits and words, the NT20S can be controlled by the PC. It is also possible to send data to the PC by pressing the touch switches on the NT20S.

- Controlling the NT20S by a PC

The following NT20S functions can be controlled by a PC.

Screens	: Display of designated screens, confirmation of screen numbers, etc.
Memory tables	: Writing to a memory table, copying from a memory table to another memory table, etc.
Lamps and touch switches	: Display instructions, confirmation of display status, etc.
System control	: Buzzer ON/OFF, backlight ON/OFF, and other NT20S status

- Notifying from the NT20S to a PC

Data in the NT20S is sent to a PC when a touch switch is pressed. The following types of data are sent to a PC.

- NT20S status
- Touch switch status
- Numerical values input with touch switches by using the numeral setting function
- Changes in a memory table after copying between memory tables

Functions of Display Elements

- Lamps

Allocation destination: Bit

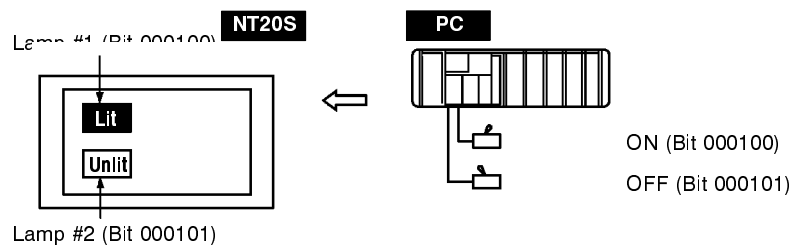

PC's bit status is displayed by the "Lamp" on the NT20S.

The lamp comes on (flashes) when the PC's bit status (lamp bit) is ON (1), and goes off when it is OFF (0).

- Touch switches

Allocation destination: Bit

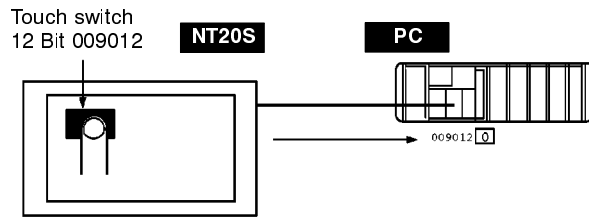

The lamp comes on (flashes) when the PC's control bit is ON (1) and goes off when it is OFF (0). When the touch switch is pressed, the PC's notification bit comes ON (1) or goes OFF (0).

- Numeral memory table

Allocation destination: Word

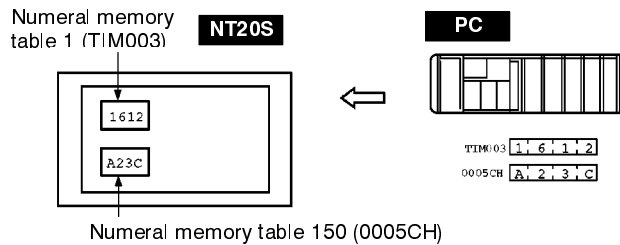

Allocate numeral memory tables to arbitrary words in the PC. If word contents change when corresponding numeral memory table is displayed on the screen, the value on the screen will also change. Monitoring of words can also be made easily.

Reading and writing are executed so that the contents of allocated words and contents of numeral memory tables are always the same during display.

- Character-string memory table

Allocation destination: Word

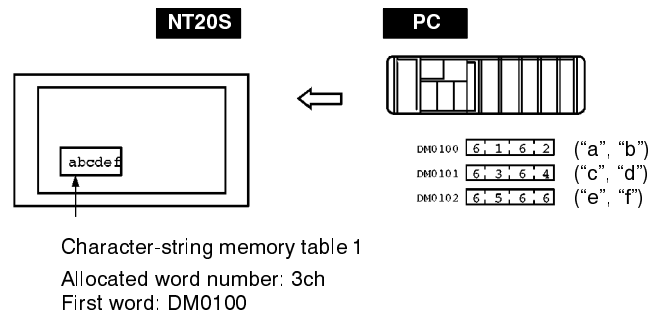

Allocate character-string memory tables to arbitrary words in the PC. If word contents change when corresponding character-string memory table is displayed on the screen, the value on the screen will also change. Messages can be displayed easily.

Reading and writing are executed so that the contents of allocated words and contents of character string memory tables are always the same during display.

Functions of the PT Status Control Area (PC to NT20S)

The “PT status control area” is used to control the NT20S status. When data is written to this area in the PC, the NT20S reads the contents and operates according to the contents.

[Example of the PT status control area application]

When data is written to the PT status control area, the NT20S will operate as given below.

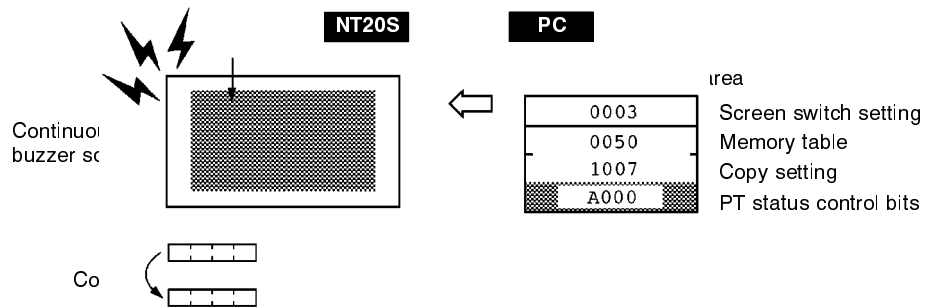

Functions of the PT Status Notify Area (NT20S to PC)

The “PT status notify area” is used to notify the changes of the NT20S status.

When a change is made in the NT20S status, the change is written to this area in the PC. By reading the data from the area, the NT20S status can be checked.

[Example of the PT status notify area application]

When a change is made in the NT20S status, such change will be notified to the PT status notify area as mentioned below.

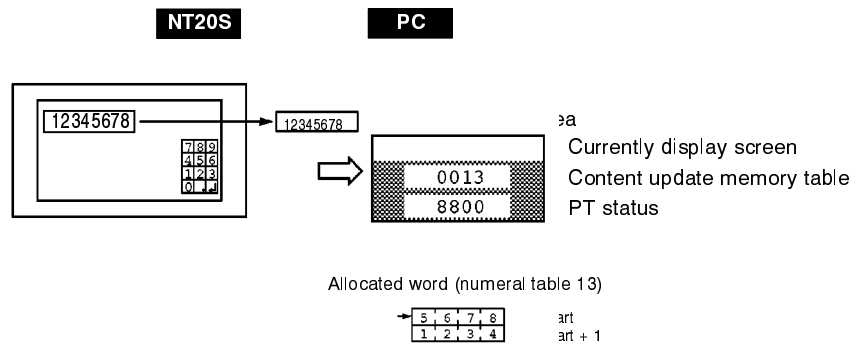

1-6 Communications by RS-232C

This section gives a brief description of the NT20S control commands sent from the host through the RS-232C interface when the NT20S-ST128 is used.

➔ For details of each of the commands sent through the RS-232C interface, refer to Section 6 "Using the RS-232C".

Control of the NT20S by a Host is executed by two kinds of commands supported by the RS-232C interface which is built into the NT20S.

Operation commands

Operation commands are used to control the display and status of the running NT20S as well as to notify information.

They are used for purposes such as screen display, data writing, and enquiries.

Notification of the NT20S operation contents to the Host.

Terminal commands

Terminal commands are used to use the NT20S as a display terminal of the Host.

When the NT20S is used as a display terminal, it can display characters and figures in accordance with instructions given by the Host, independently of the screens registered to the NT20S.

These commands are also used if unexpected problems occur.

1-7 Before Operating

Follow the procedure given below to start the system of the NT20S.

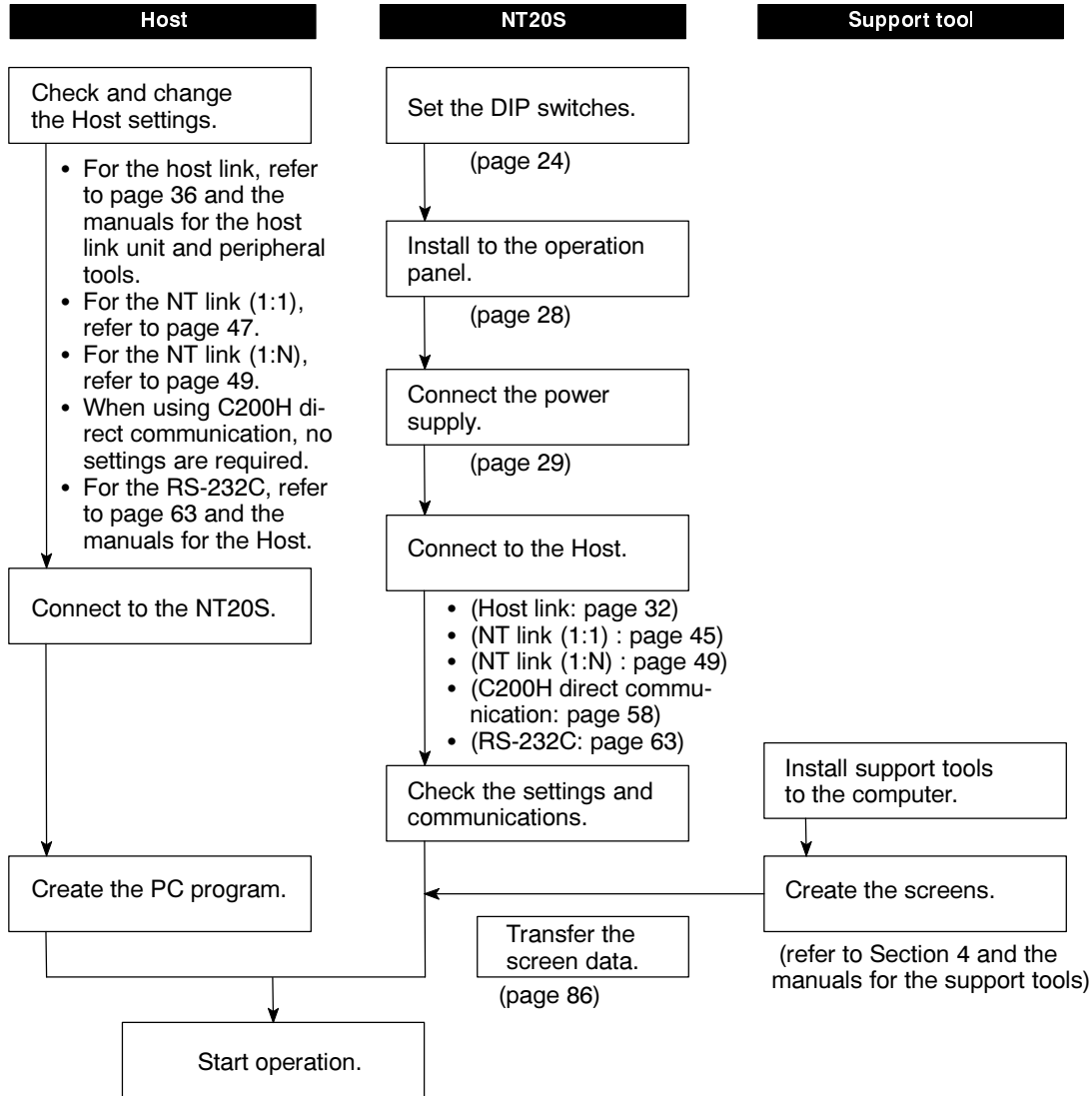

Reference: As far as possible, use NT series support tool Ver.2.□ as the support tool. For details on the support tools that can be used, see Appendix F “Function Restrictions Depending on the Support Tool” (page 255).

Refer to the following manuals for the equipment and software.

Equipment or Software	Manual Title	Manual Number
Support tools	NT-series Support Tool Operation Manual	V028-E1-□
PCs	SYSMAC C20H/C28H/C40H/C60H Operation Manual (Programming/RS-232C Interface)	W176-E1-□
	SYSMAC C120/C500 User's Manual (Programming)	W060-E1-□
	SYSMAC C200H Operation Manual	W130-E1-3□
	SYSMAC C200HS Installation Guide	W236-E1-□
	SYSMAC C200HS Operation Manual	W235-E1-2□
	SYSMAC C200HX/HG/HE Installation Guide	W302-E1-□
	SYSMAC C200HX/HG/HE Operation Manual	W303-E1-□
	SYSMAC C1000H/C2000H Operation Manual	W140-E1-□
	SYSMAC CQM1 Operation Manual	W226-E1-□
	SYSMAC CQM1-CPM1 Programming Manual	W228-E1-□
	SYSMAC CV500/CV1000/CV2000 Operation Manual (Ladder) * For a PC of the CVM1 series, refer to the SYSMAC CV500/CV1000/CV2000 User's Manual.	W202-E1-□
Peripheral tools	SYSMAC C-series and CVM1 PCs SYSMAC Support Software Operateon Manual:C-series PCs	W248-E1-□
	SYSMAC C-series and CVM1 PCs SYSMAC Support Software Operation Manual:CVMQ PCs	W249-E1-□
Host link Unit	SYSMAC C Series Host Link Unit System Manual	W143-E1-□
	SYSMAC CVM1/CV Series Host Link System Operation Manual	W205-E1-□

SECTION 2

Hardware Settings and Connections

This section describes the settings of the NT20S, connections to a Host, and other hardware settings.

2-1	Description of Parts and Settings	22
2-1-1	Description of Parts	22
2-1-2	Operation Status DIP Switch Settings	24
2-1-3	Setting the Communication Condition Setting Switches (NT20S-ST122-V1 Only)	25
2-2	Installation	27
2-2-1	Installation Environment	27
2-2-2	Installation to the Operation Panel	28
2-2-3	Power Supply Connection	29
2-3	Connecting to the Support Tool	31
2-4	Connection to a PC by the Host Link	32
2-4-1	Compatible PCs	32
2-4-2	Connecting the NT20S	34
2-4-3	PC Switch Settings	36
2-5	Connection to a PC by the NT Link	45
2-5-1	Compatible PCs	45
2-5-2	Connecting the NT20S	46
2-5-3	PC Switch Settings	47
2-6	Connection to a PC by the NT Link (1:N)	49
2-6-1	Compatible PCs	49
2-6-2	Connecting the NT20S Units	49
2-6-3	PC Switch Settings	57
2-7	Communicating with the PC Using C200H Direct Communication	58
2-7-1	Applicable PC Units	58
2-7-2	Connection Method	59
2-7-3	Switching the Power ON/OFF When Using C200H Direct Communication	62
2-8	Host Connections by RS-232C	63
2-8-1	Host Computer Communication Settings	63
2-8-2	Connector Pin Arrangement	63

2-1 Description of Parts and Settings

Before getting to the operation, confirm the names and functions of parts. Also set the DIP switches on the NT20S.

2-1-1 Description of Parts

Front View

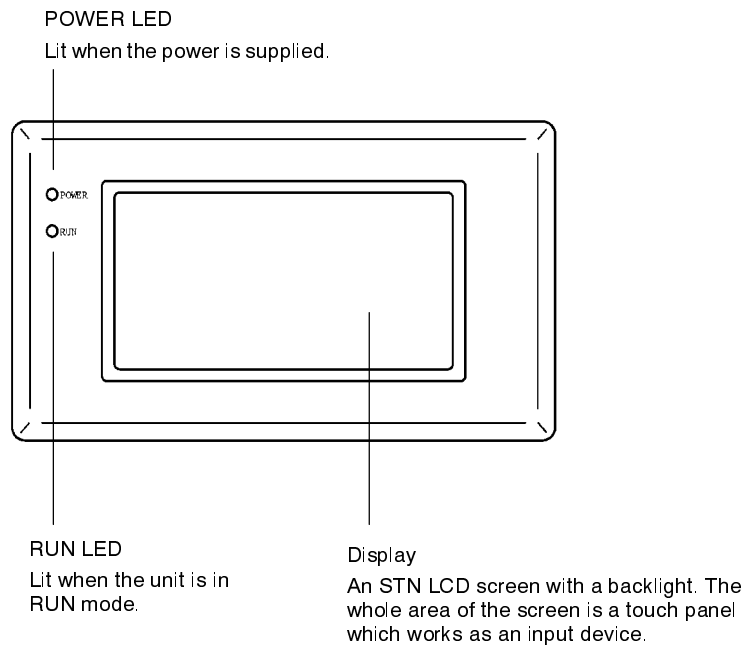

Reference: The NT20S comes in two body colors.

- NT20S-ST12□: beige
- NT20S-ST12□B: black

Rear View

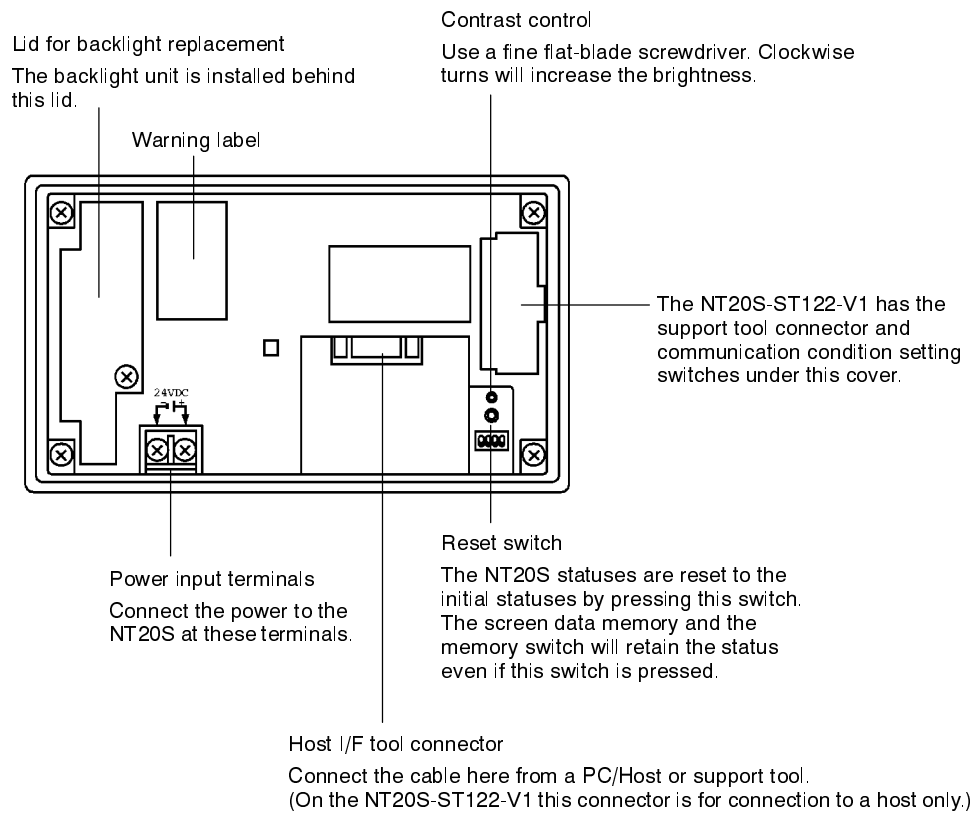

2-1-2 Operation Status DIP Switch Settings

Set the NT20S operation status with the DIP switches located in the bottom right corner on the rear side of the body.

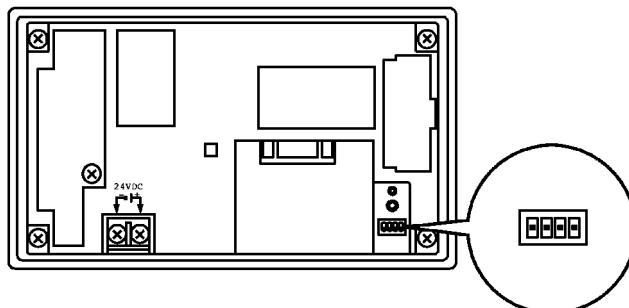

Switch #	Function	
SW2-1	Screen data forced initialize effective/ineffective	
	ON	The NT20S will start in a special RUN mode in which the screen data memory is initialized. When it is started, the memory initialization menu will be displayed. For the initialization procedure, refer to Section 3-4 Initializing Memory (page 72).
	[OFF]	The NT20S will start in normal RUN mode.
SW2-2	Screen display language mode	
	[ON]	Messages are displayed in English.
	OFF	
SW2-3	Switching to the System Menu enabled/disabled	
	ON	The System Menu cannot be displayed. If an error occurs during a start-up, the System Menu will be automatically displayed. However, "transfer mode" cannot be entered.
	[OFF]	The System Menu can be displayed.
SW2-4	Reserved for system use	
	ON	
	[OFF]	Must always be OFF.

[] indicates factory setting.

CAUTION: If the DIP switch settings have been changed when the NT20S is powered, reset the power to the NT20S. The changes with the DIP switches become effective only after the power supply is reset.

- Reference:**
- In addition to the DIP switches, set also the "communication type", "host link baud rate", etc. at the memory switches when host link/NT link is used. When using the RS-232C interface, set the "RS-232C communication conditions" and other appropriate settings. For these settings, refer to Section 3-5" Setting the Conditions of Communications with the Host by Using the Memory Switches" (page 75)
 - It may be necessary to change the DIP switch settings after installing the NT20S in an operation panel. Bear this in mind when deciding the installation position. During work at the panel, take care to ensure that no metal scraps enter the unit.

2-1-3 Setting the Communication Condition Setting Switches (NT20S-ST122-V1 Only)

When using the NT20S-ST122-V1, the communication conditions are set with the rotary switch (SW4) under the cover at the top right of the back of the terminal.

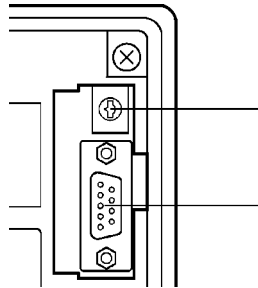

Setting the rotary switch

The rotary switch is used to set the unit number. Since the NT20S-ST122-V1 serves as a C200H special I/O unit, it requires a unit number setting. Make sure the set unit number does not duplicate the unit number set for any other special I/O unit.

SW3

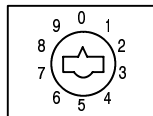

(Factory setting)

When using a C200H/C200HS, C200HX/HG/HE, the words indicated below are occupied according to the set unit number. However, since the NT20S-ST122-V1 executes processing using allocated bits and words, these words are not used for processing.

These words can be used as internal auxiliary relays.

Unit No.	Word No.
0	100 to 109
1	110 to 119
2	120 to 129
3	130 to 139
4	140 to 149
5	150 to 159
6	160 to 169
7	170 to 179
8 (*)	180 to 189
9 (*)	190 to 199

(*) Cannot be set with C□□H.

- Reference:**
- If “8” or “9” is set as the unit number when using C□□H, a special I/O unit error will occur.
 - When an NT20S-ST122-V1 is connected to a C□□H, I/O extension units cannot be connected. In other words, it is not possible to connect another special I/O unit, so whatever unit number is set will not duplicate an existing one.

2-2 Installation

Install the NT20S to the operation panel and connect the power to the NT20S as described below.

2-2-1 Installation Environment

Observe the following points when installing the PT in an operation panel.



Do not install the NT20S at sites subject to the following conditions. Otherwise, the product may malfunction.

- Severe temperature variations
- Temperatures or humidities outside the ranges stated in the specifications
- High humidity, condensation
- Splashing chemical agents
- Severe oil splashing
- Corrosive or flammable gases
- Strong vibrations or shocks
- Direct exposure to wind and rain (outdoor sites)
- Strong ultra-violet irradiation

Take adequate measures to ensure shielding if the NT20S is used at a location subject to any of the following conditions.

- Static electricity, or noise from other equipment
- Strong electric or magnetic fields
- Nearby power cables
- Potential exposure to radioactivity

2-2-2 Installation to the Operation Panel

The NT20S can be flush mounted to an operation panel.

Use the panel fittings and tools included in the product package and follow the procedure below.

⚠ Caution: During work at the panel, take care to ensure that no metal scraps enter the unit. Otherwise, the product may malfunction.

Note: The thickness of applicable operation panel is 1.6 mm to 4.8 mm. All fittings must be tightened uniformly to a torque of at least 0.5 to 0.6 N·cm in order to ensure water- and dust-resistance. The panel must not be soiled or warped, and must be able to support an installation that will remain secure and strong.

- (1) Open a hole, shown below, in the panel and install the NT20S from the front side of the panel.

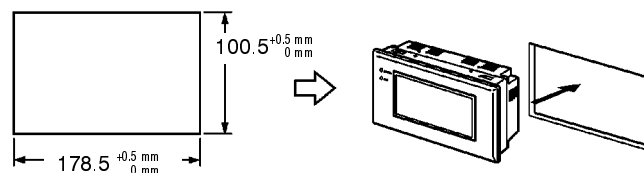

- (2) Attach the panel fittings at four positions, shown below, on the rear side of the NT20S.

Fit the hook of the fitting in the square hole in the body and tighten the screw with a Phillips head screwdriver while lightly pulling the fitting.

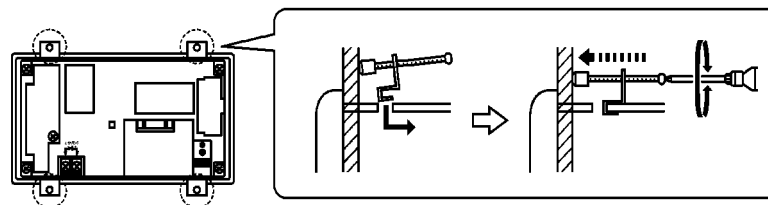

Note: In order to ensure adequate water and dustproof performance, tighten the four panel fittings uniformly and make sure there are no gaps between the fittings and the NT20S panel.

2-2-3 Power Supply Connection

Connect a 24 VDC power supply to the power input terminals.

- Note:**
- Check the wiring carefully before turning on the power.
 - Do not connect an AC power supply to the power supply terminals.
 - Use a DC power supply with low voltage fluctuation.
 - If complying with EC directives (low voltage directives), use a power supply with reinforced insulation.

Reference: When using an NT20S-ST122-V1, the NT20S must be started up before the host. For details, refer to “Switching the Power ON/OFF When Using C200H Direct” (page 62). When not using C200H direct communication, there are no restrictions on the order in which power supplies are switched ON and OFF.

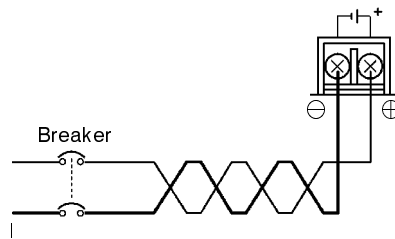

- Power supply
The specifications of the power supply that can be connected are as follows.

Item	Value
Power supply voltage	24 VDC
Allowable power supply voltage fluctuation range	20.4 VDC to 26.4 VDC (24 VDC -15%, +10%)
Power supply capacity	10 W or over

- Parts used for connection

⚠ Caution:

For the connection to the power supply terminal block, twisted wires of 2 mm² or greater cross sectional area and M3.5 size crimp terminals must be used. Tighten the screws on the terminal block to a torque of 0.8N·m. Otherwise fire may occur.

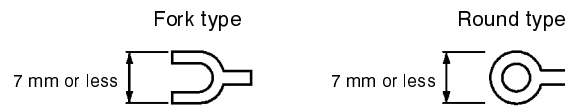

[Recommended terminals]

Maker	Type (fork type)	Type (round type)	Applicable Wire (stranded wire)
Japan Solderless Terminal MFG	2-YS3A	2-3.5	2.00 to 2.63 mm ²
Fuji Terminal	2-YAS3.5	V2-S3.5	
Nichifu Terminal	2Y-3.5	2-3.5	

2-3 Connecting to the Support Tool

Connect the NT20S to a computer with an RS-232C cable to transfer the screen data created by using a support tool to the NT20S.

An NT20S-ST121-EV3/ST128 cannot be connected to both a personal computer running the support tool and a Host at the same time. Connect the personal computer only when transmitting screen data.

[NT20S-ST121-EV3/ST128]

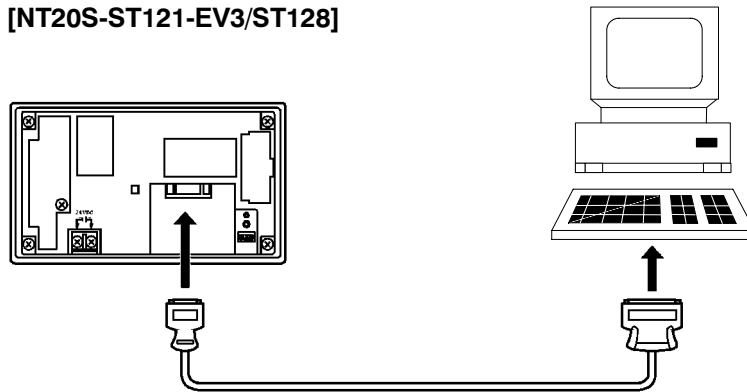

[NT20S-ST122-V1]

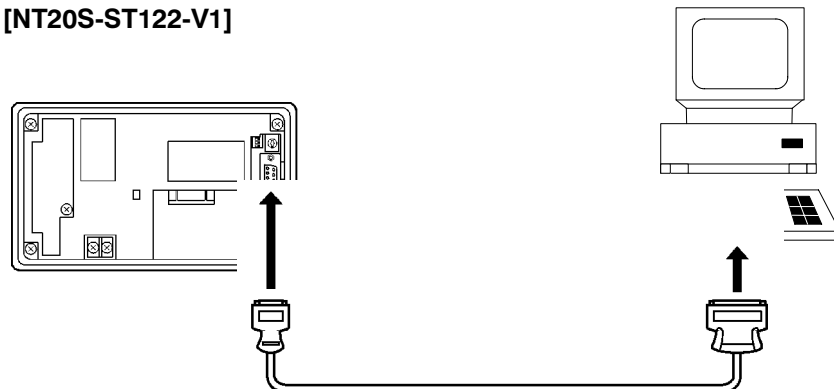

- Communication conditions

Communication conditions are set when a support tool is started.

Reference: To make a connector cable, refer to Appendix H Making the Cable for Connection to the Support Tool (page 268).

2-4 Connection to a PC by the Host Link

Connect the NT20S-ST121-EV3 to an OMRON PC by the host link method.

To connect the NT20S to a PC using the host link method, the NT20S “Comm. Type” memory switch must be set to “Host Link”. For details on the “Comm. Type” setting, refer to “Selecting the Host Communication Method” (page 78).

2-4-1 Compatible PCs

Some models and series of OMRON PCs have the host link function built in. In the C200HX/HG/HE series, there are CPU units that can support host link connections by installing an expansion communication board.

When making a connection, check the series and model of the PC to which the connection is being made, and the type of host link unit that is installed. The following is a list of the PCs that can be connected to the NT20S via a host link.

PC Series	Units with Built-in Host Link Function		CPU Units Connectable Using an Expansion Communication Board	Connectable to
	Host Link Unit	CPU Unit		
C series		C20H/C28H/ C40H/C60H		C□□H
	C120-LK201-V1			C120 C200H C500 (F) C1000H C2000 (H)
	C200H-LK201-V1			C200H
	C200H-LK201-V1	C200HS-CPU21-E C200HS-CPU23-E C200HS-CPU31-E C200HS-CPU33-E		C200HS
	C200H-LK201-V1	C200HE-CPU42-E	C200HE-CPU32-E C200HE-CPU42-E	C200HE
	C200H-LK201-V1	C200HG-CPU43-E C200HG-CPU63-E	C200HG-CPU33-E C200HG-CPU43-E C200HG-CPU53-E C200HG-CPU63-E	C200HG
	C200H-LK201-V1	C200HX-CPU44-E C200HX-CPU64-E	C200HX-CPU34-E C200HX-CPU44-E C200HX-CPU54-E C200HX-CPU64-E	C200HX
	C500-LK201-V1 C500-LK203			C500 (F) C1000H (F) C2000 (H)
		CPM1-10CDR-□ CPM1-20CDR-□ CPM1-30CDR-□		CPM1
		CQM1-CPU21-E CQM1-CPU41-E CQM1-CPU42-E CQM1-CPU43-E CQM1-CPU44-E		CQM1

PC Series	Units with Built-in Host Link Function		CPU Units Connectable Using an Expansion Communication Board	Connectable to
	Host Link Unit	CPU Unit		
CV series	CV500-LK201	CV500-CPU01-EV1		CV500
	CV500-LK201	CV1000-CPU01-EV1		CV1000
	CV500-LK201	CV2000-CPU01-EV1		CV2000
CVM1 series	CV500-LK201	CVM1-CPU01-EV□ CVM1-CPU11-EV□ CVM1-CPU21-EV□		CVM1

* Connection is not possible to the CPU units of CVM1/CV series PCs that do not have the suffix “-EV□”.
In the case of these CPU units, make the connection to NT20S by using a host link unit.

2-4-2 Connecting the NT20S

Refer to the illustrations below to select the appropriate cable for the unit connectors and connect the NT20S to the PC/Host.

To make a connector cable, refer to Appendix G Method for Making the Cable for Connection to the Host (page 256).

Caution:

- After connecting the communication cable, always secure it with the screws. Otherwise the cable may disconnect, causing operation to fail.
- The cable's tensile load is 30 N. Do not subject it to loads greater than this. Otherwise a discontinuity may occur, causing operation to fail.

Connecting to a PC with a 25-pin Connector

Use a connector cable with a 25-pin connector on one end and a 9-pin connector on the other end (NT20S side) to connect the NT20S to a PC with a 25-pin connector.

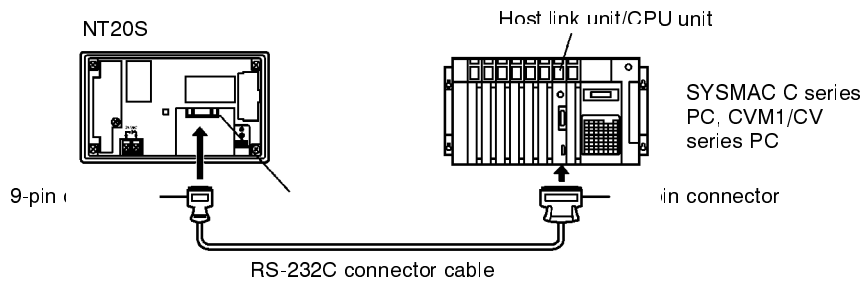

Use the following recommended cables (OMRON);

Connector Specification	Type	Cable Length	Applicable Host Link Unit
25-pin to 9-pin	XW2Z-200S	2m	C500-LK203 C500-LK201-V1 C120-LK201-V1
	XW2Z-500S	5m	C200H-LK201 CV500-LK201

Connecting to a PC with a 9-pin Connector

Use a connector cable with a 9-pin connector on both ends to connect the NT20S to a PC with a 9-pin connector.

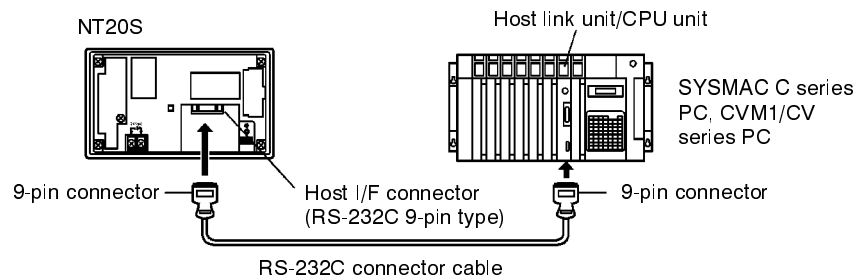

Note: The connector cable wiring for the C series CPU unit (C□□H) is different from that for the other PCs. For details, refer to Appendix G Method for Making the Cable for Connection to the Host (page 256).

Connecting the NT20S to a CVM1/CV Series Host Link Unit

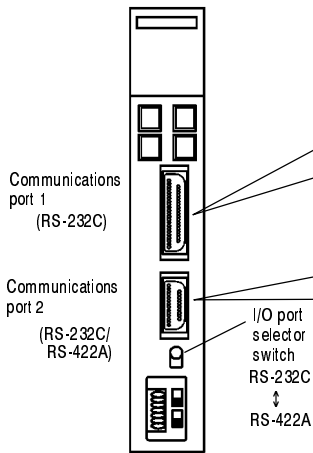

Two types of connectors are provided to CV500-LK201 host link unit. Both of these connector types can connect to the NT20S with an RS-232C connector cable. Select the connector cable which matches the connector type.

- To connect to communication port 1
This is a 25-pin RS-232C connector. Use a connector cable with a 25-pin connector on one end and a 9-pin connector on the other end (NT20S side).

- To connect to communication port 2
This is a 9-pin RS-232C/RS-422A connector. Use a connector cable with a 9-pin connector on both ends.

Set the I/O port selector switch to the RS-232C side (upper side) to use this port.

Connecting the NT20S to a C Series CQM1 Unit

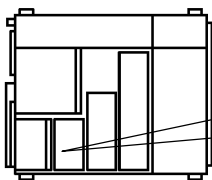

CQM1 can connect to the NT20S by the RS-232C method. Use an RS-232C 9-pin type connector cable.

- To connect to the RS-232C port
This is a 9-pin RS-232C connector. Use a connector cable with a 9-pin connector on both ends.

Connecting to C Series C200HX/HG/HE

When using C series C200HX/HG/HE models, the NT20S can be connected to the standard port of the CPU unit, or to ports A and B of the expansion communication board. Procure an RS-232C 9-pin type connection cable for the connection. For details on the specifications, installation method, etc., of the communication board used for the connection, refer to the "SYSMAC C200HX/HG/HE Installation Guide" (W302-E1-□).

Connecting to C Series CPM1

The CPM1 is connected via an RS-232C adapter (type CPM1-CIF01). Procure an RS-232C 9-pin type connection cable for the connection.

When a Connection Cable Longer Than 5 m is Required

When a connection cable longer than 5 m is required, it must be specially made. However, note that the maximum transmission distance is 15 m. For details on the method for making the connection cable, refer to Appendix G "Method for Making the Cable for Connection to the Host" (page 256).

When Long-Distance Transmission is Required

When transmission over a distance exceeding the RS-232C specification is required, it can be achieved by using an RS-232C/RS-422A converter unit (type NT-AL001) to switch to RS-422A communication (RS-485 communication cannot be used).

For details, refer to “Connecting to an RS-232C/RS-422A Converter Unit (1:1)” (page 269).

2-4-3 PC Switch Settings

When the NT20S and PC are connected to each other, set the conditions at the PC host link unit or the CPU as given in the table below.

The following is a general description of switch settings.

Refer to the manual for respective units for the details of the switch settings.

Item	Switch Setting
I/O port	RS-232C
Baud rate	Set the same baud rate as the NT20S. (*1)
Transfer code	ASCII 7 data bits, 2 stop bits
Parity	Even
1-to-1/1-to-N	1-to-N (*2)
Instruction level	Level 1, 2, 3
Unit #	00

- Note:**
1. Set the host link baud rate at 9600 bps or 19200 bps with the memory switch for “host link baud rate”. For the details, refer to “Selecting the Host Link Communication Speed” (page 79).
 2. The 1-to-N setting enables BCC (Block Check Character).
It is not possible to connect more than one NT20S in a single host link.

When using CVM1/CV series, always set CPU execution processing (execution control 2) in the PC system settings to simultaneous processing.

Connecting to a Host Link Unit

Two types of host link units are available: a rack-mounting type and a CPU-mounted type. The switch settings differ according to the type of host link unit. Set the switches according to the unit type.

- C200H rack-mounting type: C200H-LK201(-V1)

[Setting the front switches]

Set each switch with a flat blade screwdriver so that the values or symbols in the setting value window agree with the following.

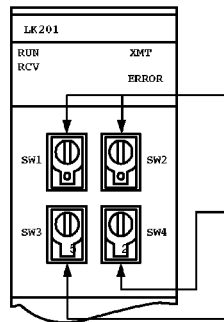

- Unit # (SW1, SW2)
Set these switches to "0".
- Instruction level, parity, and transfer code (SW4)
Set this switch to "2".
- Baud rate (SW3)
Set this switch to "5" to select 9600 bps.
Set this switch to "6" to select 19200 bps.

[Setting the rear switches]

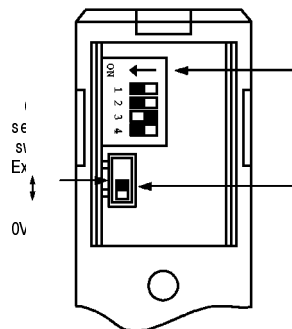

- 1-to-1/1-to-N selection (DIP switch)
Set #3 to "ON".
- CTS selection (selector switch)
Set this always to "0V" (ON).

- C500/C1000H/C2000(H) rack-mounting type: C500-LK201-V1

[Setting the front switches]

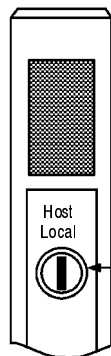

- Mode control (key switch)
Set this to "host link".

[Setting the rear switches]

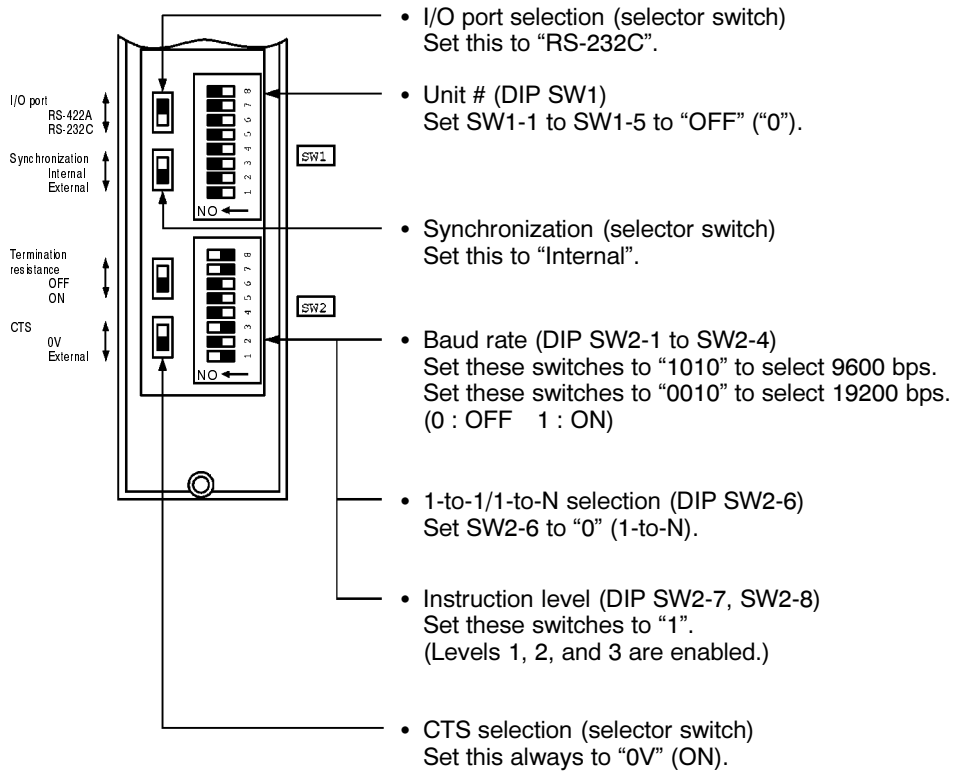

- C500/C1000H/C2000(H) rack-mounting type: C500-LK203

[Setting the rear switches]

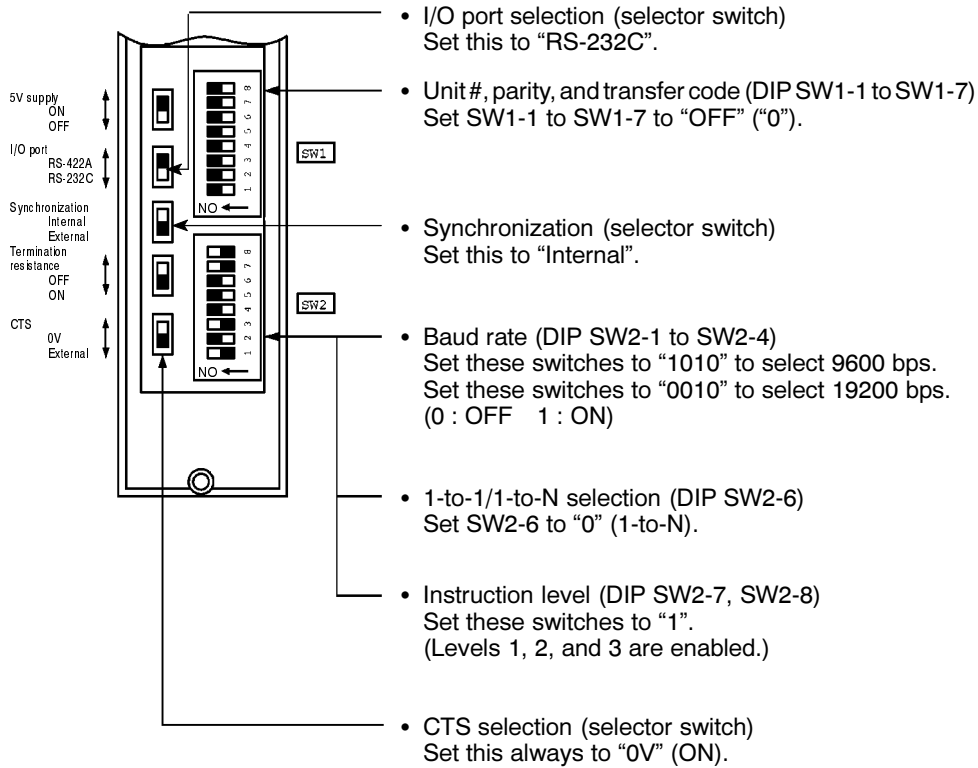

- CPU-mounted type: C120-LK201-V1

[Setting the rear switches]

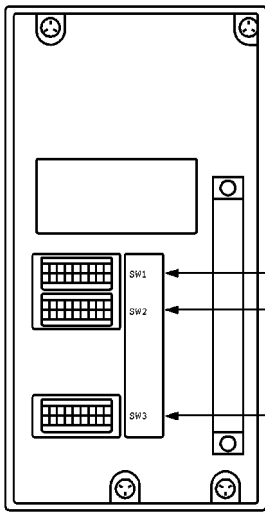

- Unit #, parity, and transfer code (DIP SW1-1 to SW1-5)
Set SW1-1 to SW1-5 to "OFF" ("0").
* Parity is fixed at Even Parity. Transfer code is fixed at ASCII 7 data bits and 2 stop bits.
- Baud rate (DIP SW2-1 to SW2-4)
Set these switches to "1010" to select 9600 bps.
Set these switches to "0010" to select 19200 bps.
(0 : OFF 1 : ON)
- 1-to-1/1-to-N selection (DIP SW2-6)
Set SW2-6 to "0" (1-to-N).
- Instruction level (DIP SW2-7, SW2-8)
Set these switches to "1".
(Levels 1, 2, and 3 are enabled.)
- CTS selection (DIP SW3-1 and SW3-2)
Set SW3-1 to "ON" (1) and SW3-2 to "OFF" (0). (Set this always to "0V".)
- Synchronization (DIP SW3-3 to SW3-6)
Set SW3-3, SW3-5, and SW3-6 to "ON" (1), and SW3-4 to "OFF" (0). (Set these to "Internal".)

- CVM1/CV series backplate mounted type: CV500-LK201

[Setting the front switches]

Set the operating conditions with the PC System Setting functions when a CVM1/CV series host link unit is connected to the NT20S. The PC system settings can be made directly from the peripheral tool (LSS etc.) or the PC system setting information created with a peripheral tool can be transferred to the CPU.

The following describes the switch settings so as to enable the PC system settings. For the details of the PC system settings, refer to the SYSMAC CVM1/CV Series Host Link User's Manual (W205-E1-□).

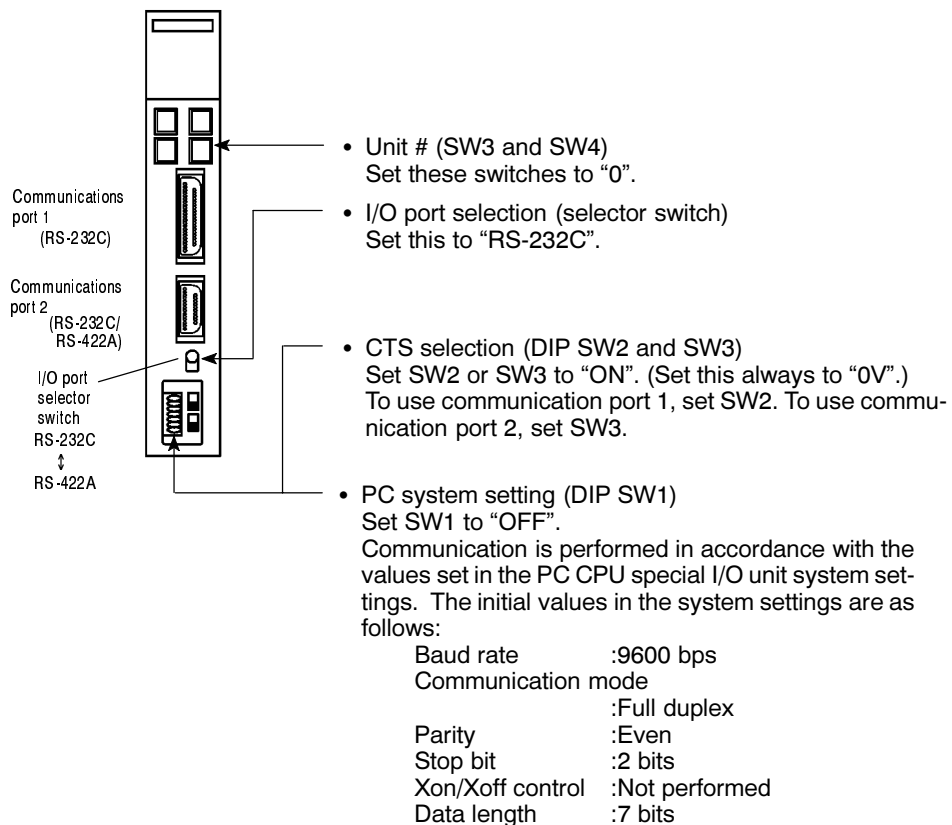

Connecting to a CPU

- C-series C□□H, CVM1/CV-series (-EV□)

Set the operating conditions with the PC System Setting functions when a C□□H, CVM1/CV-series host link unit is connected to the NT20S. The PC system settings can be made directly from the peripheral tool (LSS etc.) or the PC system setting information created with a peripheral tool can be transferred to the CPU.

The following describes the switch settings so as to enable the PC system settings. For the details of the PC system settings, refer to the “SYSMAC C□□H User’s Manual (Programming)” (W176-E1-□) and the CVM1/CV500/CV1000/CV2000 User’s Manual (W195-E1-□).

- (1) C-series C□□H : C20H/C28H/C40H/C60H

No switch settings are required when connecting to a C-series C□□H CPU.

- (2) CVM1/CV-series : CV500-CPU01-EV1
CV1000-CPU01-EV1
CV2000-CPU01-EV1
CVM1-CPU01-EV□
CVM1-CPU11-EV□
CVM1-CPU21-EV□

Only CVM1/CV series CPU units designated “-EV1” or higher can be connected.

When connecting to a CVM1/CV-series CPU, set the switches as given below.

[Setting the front switches]

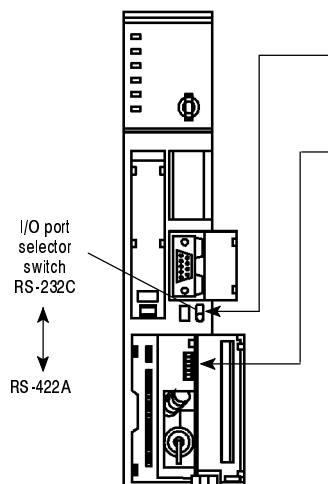

- I/O port selection (selector switch)
Set this to “RS-232C”.
- System setting (DIP SW4)
To effect the existing DIP switch settings, set SW4 to “ON”.
To effect the existing PC system settings, set SW4 to “OFF”.
Note: In the case of CPU units manufactured before June 1995 (lot No. “□□65”), the factory settings of the DIP switches do not agree with the factory settings for the PC system settings.
 - The factory settings for the DIP switches are:
2400 bps, 1 stop bit, even parity, 7-bit data length.
 - The factory settings for the PC system settings are:
9600 bps, 2 stop bits, even parity, 7-bit data length.
 For CPU units manufactured from July 1995 (lot No. “□□75”) onward, the factory settings for the DIP switches are also 9600 bps and 2 stop bits.

[Making the PC system settings]

The possible settings and existing settings which can be set by the PC system setting are as given below.

Item	Possible Setting	Existing Setting
Baud rate	1200/2400/4800/9600/19200 bps	9600 bps
Stop bit	1 or 2 stop bits	2 stop bits
Parity	Even/odd/non-parity	Even parity
Data length	ASCII 7 bits or JIS 8 bits	ASCII 7 bits
Unit #	00 to 31	Unit #00

- C-series C200HS, C200HX/HG/HE, CPM1, CQM1

Set the operating conditions to the PC system setting area when a C200HS C200HX/HG/HE, CPM1 or CQM1 CPU is connected to the NT20S. The PC system setting area (data memory) can be directly accessed from the peripheral tool (LSS etc.).

The following describes the switch settings so as to enable the PC system settings. For the details of the operation with the PC system setting area, refer to the manual for the PC you are using.

[Switch setting] (C200HX/HG/HE, CQM1)

DIP switch settings

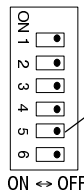

- RS232C port communication condition settings
Set DIP switch 5 to OFF (right side) to enable the PC system settings.

[Switch setting] (CPM1)

Set the mode setting switch to the "HOST" (upper) position.

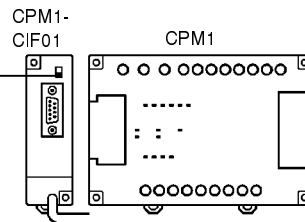

[PC system setting area settings]

Write values to the PC system setting area (data memory) in accordance with the CPU unit port used for connection to the NT20S.

- When using the RS232 port of C200HX/HG/HE, CQM1

Channel #	Writing Value	Settings
DM6645	0001	Host link mode Set the conditions with the contents of DM.
DM6646	0303	Data length: 7 bits, 2 stop bits, even parity, baud rate: 9600 bps.
	0304	Data length: 7 bits, 2 stop bits, even parity, baud rate: 19200 bps.
DM6648	0000	Unit No. 0

- When using port A of C200HX/HG/HE

Channel #	Writing Value	Settings
DM6555	0001	Host link mode Set the conditions with the contents of DM.
DM6556	0303	Data length: 7 bits, 2 stop bits, even parity, baud rate: 9600 bps
	0304	Data length: 7 bits, 2 stop bits, even parity, baud rate: 19200 bps
DM6558	0000	Unit No. 0

- When using port B of C200HX/HG/HE

Channel #	Writing Value	Settings
DM6550	0001	Host link mode Set the conditions with the contents of DM.
DM6551	0303	Data length: 7 bits, 2 stop bits, even parity, baud rate: 9600 bps
	0304	Data length: 7 bits, 2 stop bits, even parity, baud rate: 19200 bps
DM6553	0000	Unit No. 0

- When using CPM1

Channel #	Writing Value	Settings
DM6650	0001	Host link mode Set the conditions with the contents of DM.
DM6651	0303	Data length: 7 bits, 2 stop bits, even parity, baud rate: 9600 bps
	0304	Data length: 7 bits, 2 stop bits, even parity, baud rate: 19200 bps
DM6653	0000	Unit No. 0

2-5 Connection to a PC by the NT Link (1:1)

Connect the NT20S-ST121-EV3 to an OMRON PC by the NT link method.

To connect the NT20S to a PC by the NT link (1:1) method, the NT20S memory switch for “host communication” must be set for the NT link. For the “host communication” setting, refer to “Selecting of the Host Communication Method” (page 78).

2-5-1 Compatible PCs

Some models and series of OMRON PCs have the host link function built in. In the C200HX/HG/HE series, there are CPU units that can support host link connections by installing an expansion communication board.

When making a connection, check the series and model of the PC to which the connection is being made, and the type of host link unit that is installed. The following is a list of the PCs that can be connected to the NT20S via a host link.

The compatible PCs are listed in the table below.

PC Series	CPU Unit	CPU Units Connectable Using an Expansion Communication Board	Connectable to
C series	CPM1-10CDR- <input type="checkbox"/> CPM1-20CDR- <input type="checkbox"/> CPM1-30CDR- <input type="checkbox"/>		CPM1
	CQM1-CPU41-E CQM1-CPU42-E CQM1-CPU43-E CQM1-CPU44-E		CQM1
	C200HS-CPU21-E C200HS-CPU23-E C200HS-CPU31-E C200HS-CPU33-E		C200HS
	C200HE-CPU42-E	C200HE-CPU32-E C200HE-CPU42-E	C200HE
	C200HG-CPU43-E C200HG-CPU63-E	C200HG-CPU33-E C200HG-CPU43-E C200HG-CPU53-E C200HG-CPU63-E	C200HG
	C200HX-CPU44-E C200HX-CPU64-E	C200HX-CPU34-E C200HX-CPU44-E C200HX-CPU54-E C200HX-CPU64-E	C200HX
CV series	CV500-CPU01-EV1		CV500
	CV1000-CPU01-EV1		CV1000
	CV2000-CPU01-EV1		CV2000
CVM1 series	CVM1-CPU01-EV <input type="checkbox"/> CVM1-CPU11-EV <input type="checkbox"/> CVM1-CPU21-EV <input type="checkbox"/>		CVM1

2-5-2 Connecting the NT20S

Refer to the illustrations below to select the appropriate cable for the unit connectors and connect the NT20S to the PC.

A host link connector cable can also be used. To make a connector cable, refer to Appendix G Method for Making the Cable for Connection to the Host (page 256).

⚠ Caution:

- After connecting the communication cable, always secure it with the screws. Otherwise the cable may disconnect, causing operation to fail.
- The cable's tensile load is 30 N. Do not subject it to loads greater than this. Otherwise a discontinuity may occur, causing operation to fail.

Use a connector cable with a 9-pin connector on both ends to connect the NT20S to a PC with a 9-pin connector.

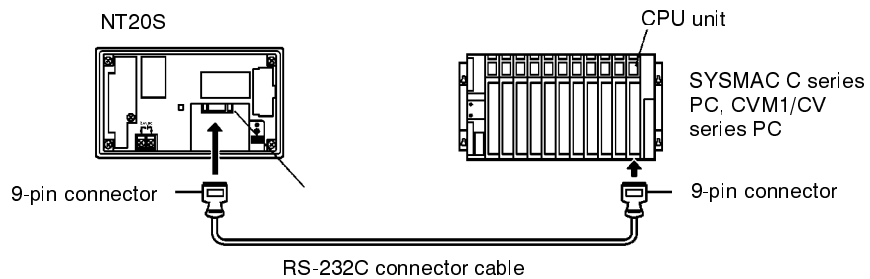

The following are the recommended cables (manufactured by OMRON).

Connector Specification	Model	Cable Length
9 pin ↔ 9 pin	XW2Z-200T	2m
	XW2Z-500T	5m

If a Cable Longer Than 5 m is Required

If a cable longer than 5 m is required, a connector cable will have to be made. Refer to Appendix F Method for Making the Cable for Connection to the Host (page 256). The maximum transmission distance is 15 m.

When Long-Distance Transmission is Required

When transmission over a distance exceeding the RS-232C specification is required, it can be achieved by using an RS-232C/RS-422A converter unit (type NT-AL001) to switch to RS-422A communication (RS-485 communication cannot be used).

For details, refer to “Connecting to an RS-232C/RS-422A Converter Unit (1:1)” (page 269).

2-5-3 PC Switch Settings

When the NT20S and PC are connected to each other, set the conditions at the PC CPU so as to enable the NT link communications.

The following is a general description of switch settings.

- C-series C200HS, C200HX/HG/HE, CPM1, CQM1

Set the operating conditions to the PC system setting area when a C200HS, C200HX/HG/HE, CPM1 or CQM1 CPU is connected to the NT20S. The PC system setting area (data memory) can be directly accessed from the peripheral tool (LSS etc.).

The following describes the switch settings so as to enable the PC system settings. For the details of the operation with the PC system setting area, refer to the manual for the PC you are using.

[Switch setting] (C200HX/HG/HE, CQM1)

DIP switch settings

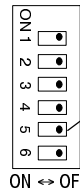

- RS-232C port communication condition settings
Set DIP switch 5 to OFF (right side) to enable setting of the PC system settings.

[PC system setting area settings] (C200HX/HG/HE, CPM1, CQM1)

Write values to the PC system setting area (data memory) in accordance with the CPU unit port used for connection to the NT20S.

PC Side	Channel #	Writing Value	Settings
RS-232 port of C200HX/HG/HE, CQM1	DM6645	4000	Use NT link (1:1)
Port A of C200HX/HG/HE	DM6555		
Port B of C200HX/HG/HE	DM6550		
CPM1	DM6650		

- CVM1/CV-series (-EV□)

When connecting to a CVM1/CV-series (-EV□) CPU, set the switches as given below.

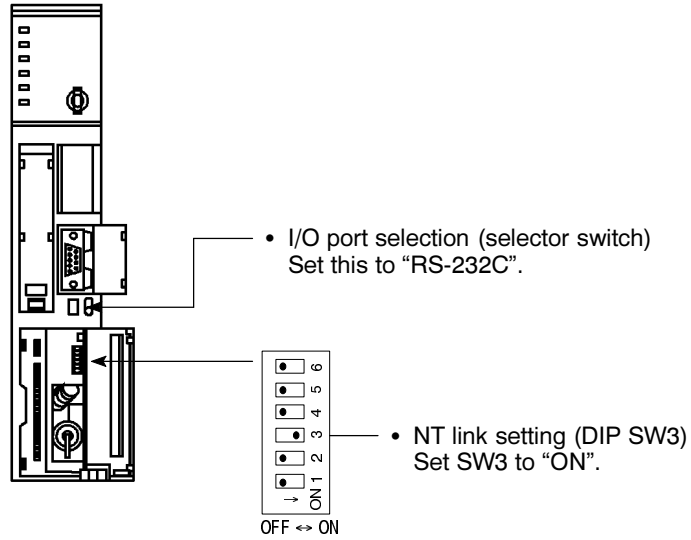

When using CVM1/CV series, always set CPU execution processing (execution control 2) in the PC system settings to simultaneous processing.

2-6 Connection to a PC by the NT Link (1:N)

Connect the NT20S to an OMRON PC by the NT link method.

To connect the NT20S to a PC by the NT link (1:N) method, the communication conditions must be set with the memory switches.

- Setting NT link (1:N)
(Refer to “Selecting the Host Communication Method” (page 78))
- Setting the unit No. of the connected NT20S
(Selecting Unit Numbers (page 80))

2-6-1 Compatible PCs

The only OMRON PCs that can be connected in an NT link (1:N) are the C series C200HX/HG/HE models. When making a connection, check the series and model of the PC to which the connection is being made, and the type of host link unit that is installed.

The following is a list of the PCs that can be connected to the NT20S via a host link (1:N).

PC Series	CPU Unit with Built-in NT Link Function	CPU Units Connectable Using an Expansion Communication Board	Connectable to
C series	C200HE-CPU42-E	C200HE-CPU32-E C200HE-CPU42-E	C200HE
	C200HG-CPU43-E C200HG-CPU63-E	C200HG-CPU33-E C200HG-CPU43-E C200HG-CPU53-E C200HG-CPU63-E	C200HG
	C200HX-CPU44-E C200HX-CPU64-E	C200HX-CPU34-E C200HX-CPU44-E C200HX-CPU54-E C200HX-CPU64-E	C200HX

2-6-2 Connecting the NT20S Units

Referring to the illustrations below and using a cable appropriate for the CPU unit’s connector, connect the NT20S units and the PC using RS-232C/RS-422A converter units (type NT-AL001).

An NT link connection cable can be used as the RS-232C cable. For details on making a connection cable, refer to Appendix G “Method for Making the Cable for Connection to the Host” (page 256).

 **Caution:**

- After connecting the communication cable, always secure it with the screws. Otherwise the cable may disconnect, causing operation to fail.
- The cable’s tensile load is 30 N. Do not subject it to loads greater than this. Otherwise a discontinuity may occur, causing operation to fail.

Reference: When connecting the C200HX/HG/HE and an RS-232C/RS-422A converter unit, use a converter unit whose lot number is 15Y5 or later. Converter units of lot numbers previous to 15Y5 cannot be connected.

Connection Diagram

As shown in the figure below, connect multiple NT20S units to one PC. In an NT link (1:N), up to eight NT20S units can be connected to one PC port.

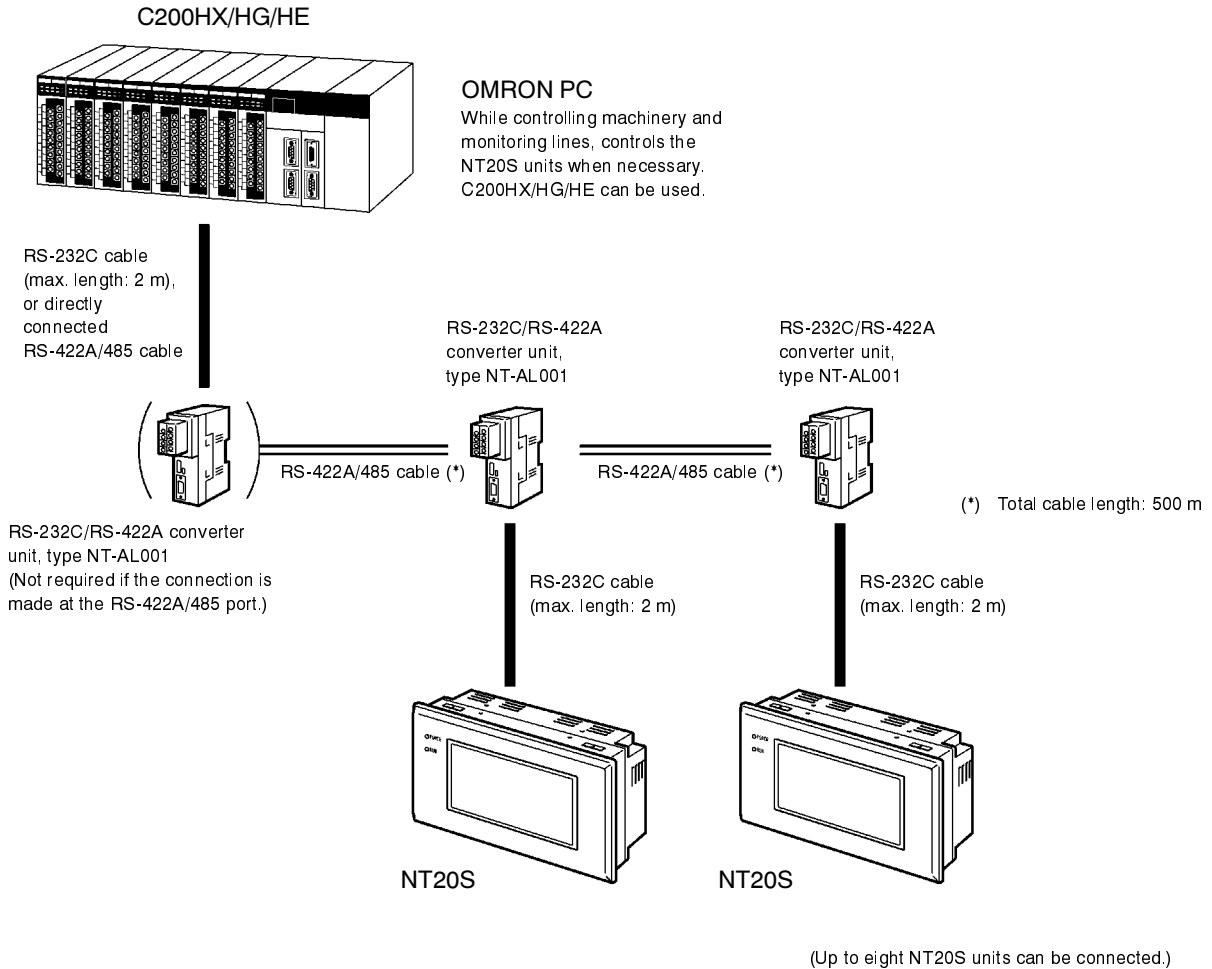

[Maximum Number of NT20Ss Connectable to One Port]

The maximum numbers of NT20S units that can be connected to one port of each of the C200HX, -HG, and -HE CPU units are indicated below.

- C200HE :Up to 4 NT20S units per port (unit Nos. 0 to 3)
- C200HG, C200HX :Up to 8 NT20S units per port (unit Nos. 0 to 7)

Converter Unit Connector Specifications

The terminal block specifications of the RS-232C/RS-422A converter unit are indicated here. For details on the method for making the connection cable, refer to “Making the Cable” (page 265).

NT-AL001 RS-422A terminal block specifications

- Connected terminal block RS-422A terminal block (M3 screws)
- Electrical characteristics Conform to EIA RS-422A
- Signal direction Signal input and output is relative to the NT-AL001.

Terminal Block Pin No.	Signal Name	Abbreviation	Signal Direction	
			Input	Output
8	Request to send (-)	CSA		○
7	Request to send (+)	CSB		○
6	Receive data (-)	RDA	○	
5	Receive data (+)	RDB	○	
4	Send data (-)	SDA		○
3	Send data (+)	SDB		○
2	Signal ground	SG (GND)	-	-
1	Functional ground		-	-

* The CSA and CSB signals are for special applications.

Terminal Screws and Crimp Terminals

The terminal screws are M3 screws. Use M3 size crimp terminals. Tighten the terminal screws with a torque of 0.4 N·m.

Note: During wiring, crimp terminals must be used for connections.

[Recommended crimp terminals]

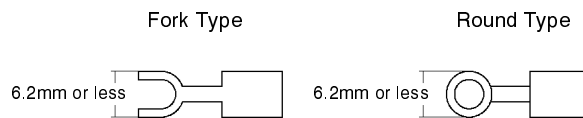

Maker	Type	Recommended Wire Size
Japan Solderless Terminal MFG	1.25-N3A (Fork)	AWG22 to 18 (0.3 to 0.75mm ²)
Molex	Y1.25-3.5L (Fork)	

Wiring Method

For the connections between the PC and NT20S units, wire as shown below. The wiring method differs depending on the cables used for connection.

- RS-422A connection

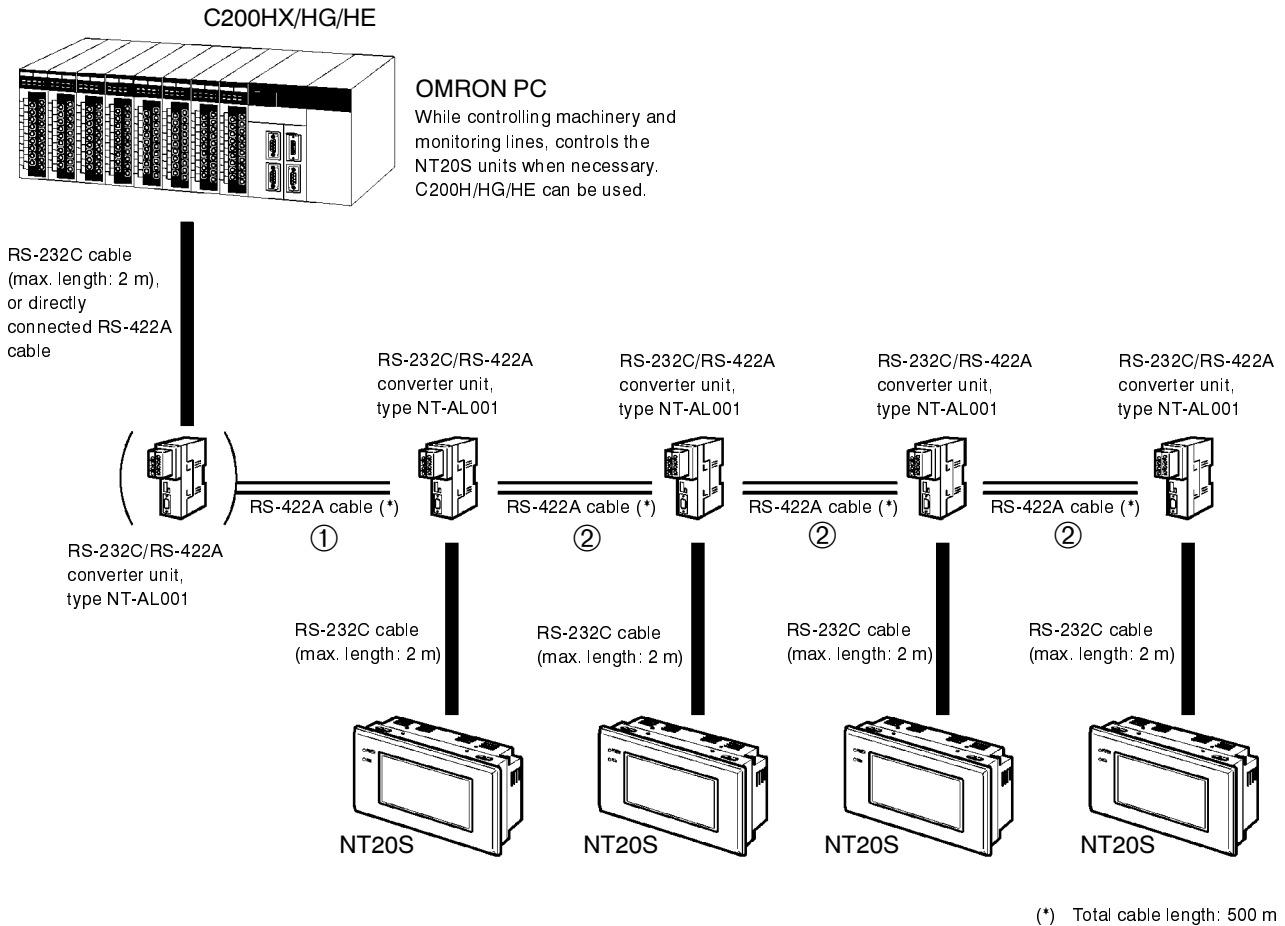

[RS-232C Cable Wiring]

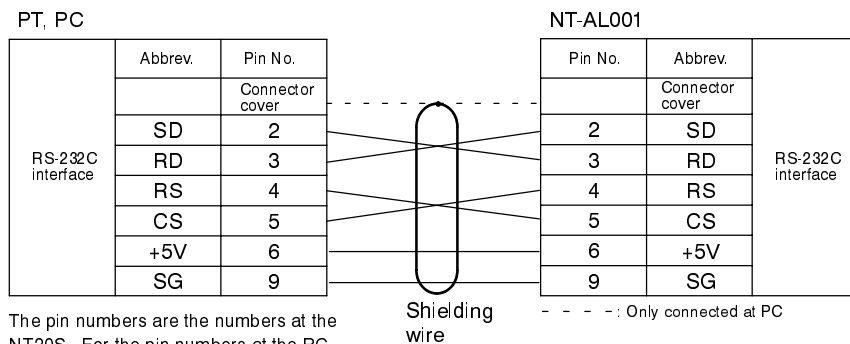

[RS-422A Cable Wiring (①)]

- RS-232C connection at the PC side

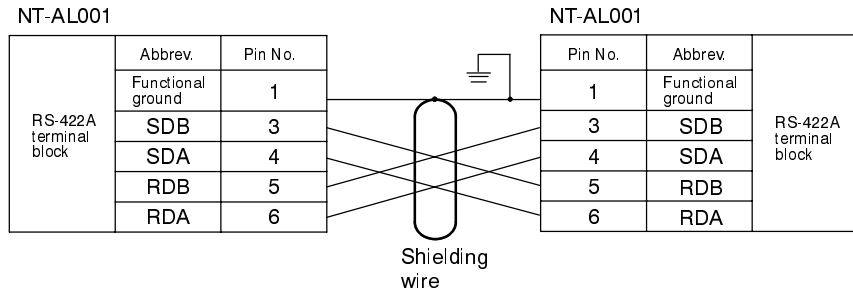

- RS-422A connection at the PC side

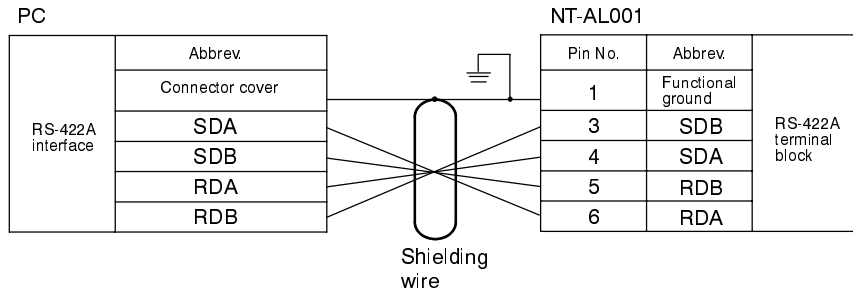

[RS-422A Cable Wiring (②)]

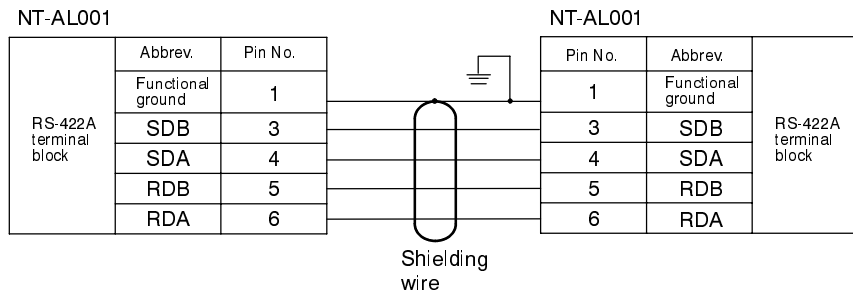

• RS-485 connection

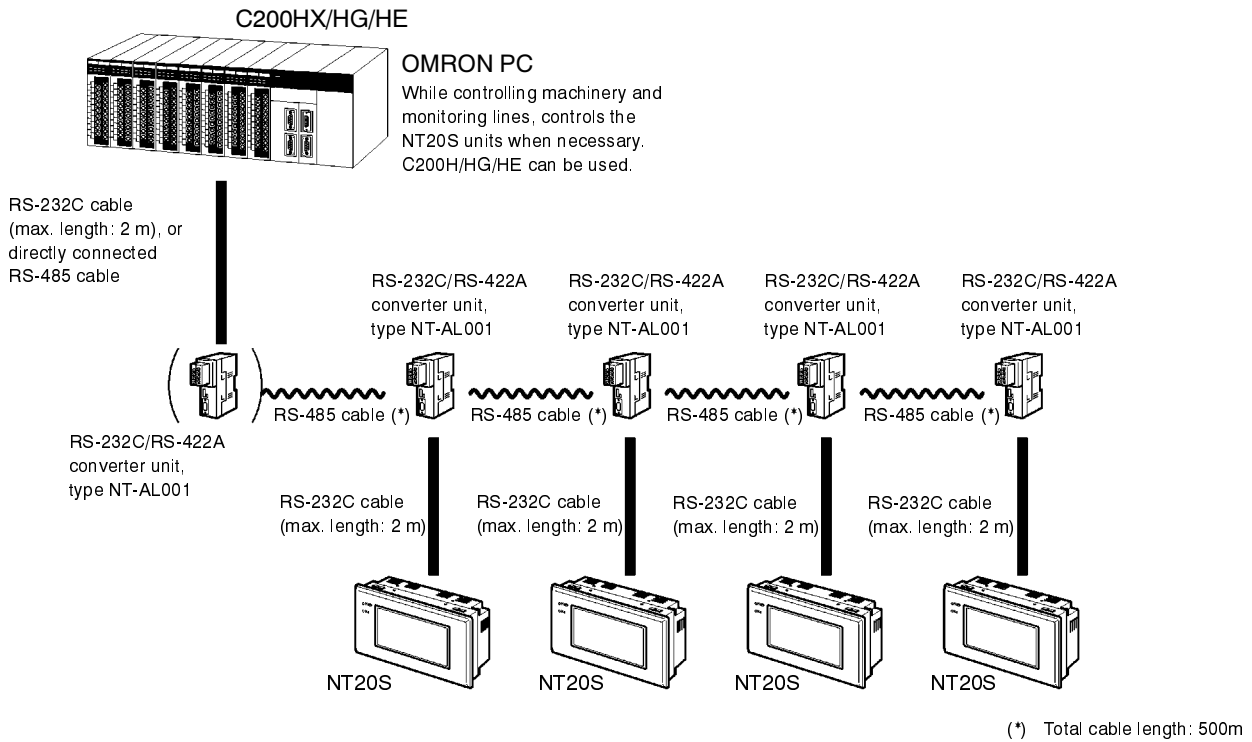

[RS-232C Cable Wiring]

Same as for an RS-422A connection. Refer to “RS-422A connection” (page 52).

[RS-485 Cable Wiring]

• NT-AL001 to NT-AL001

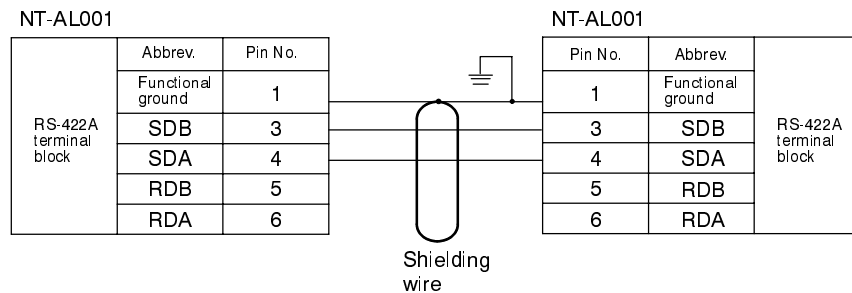

• PC to NT-AL001

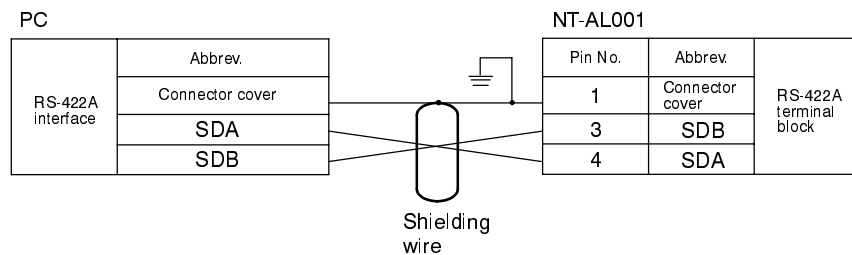

NT-AL001 Converter Unit DIP Switch Settings

The DIP switch settings to be made at an NT-AL001 used in the wiring depend on whether it is connected part way along the RS-422A/485 cable or is at the end of the RS-422A/485 cable.

- RS-422A connection, RS-232C at the PC side

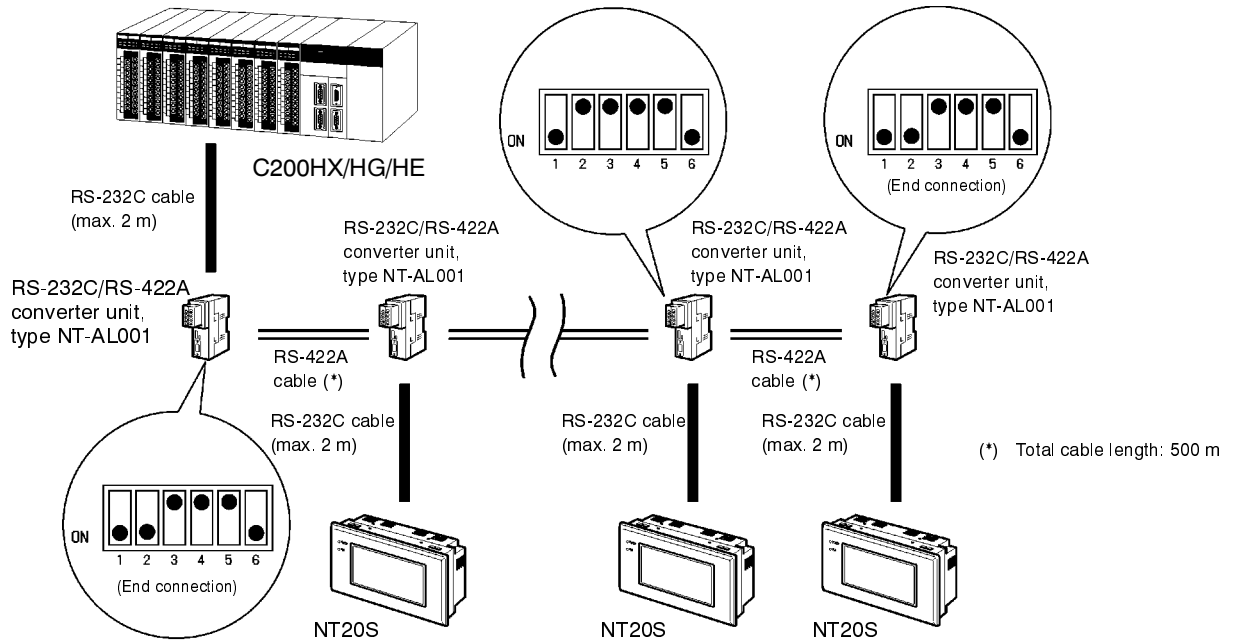

- RS-485 connection, RS-232C at the PC side

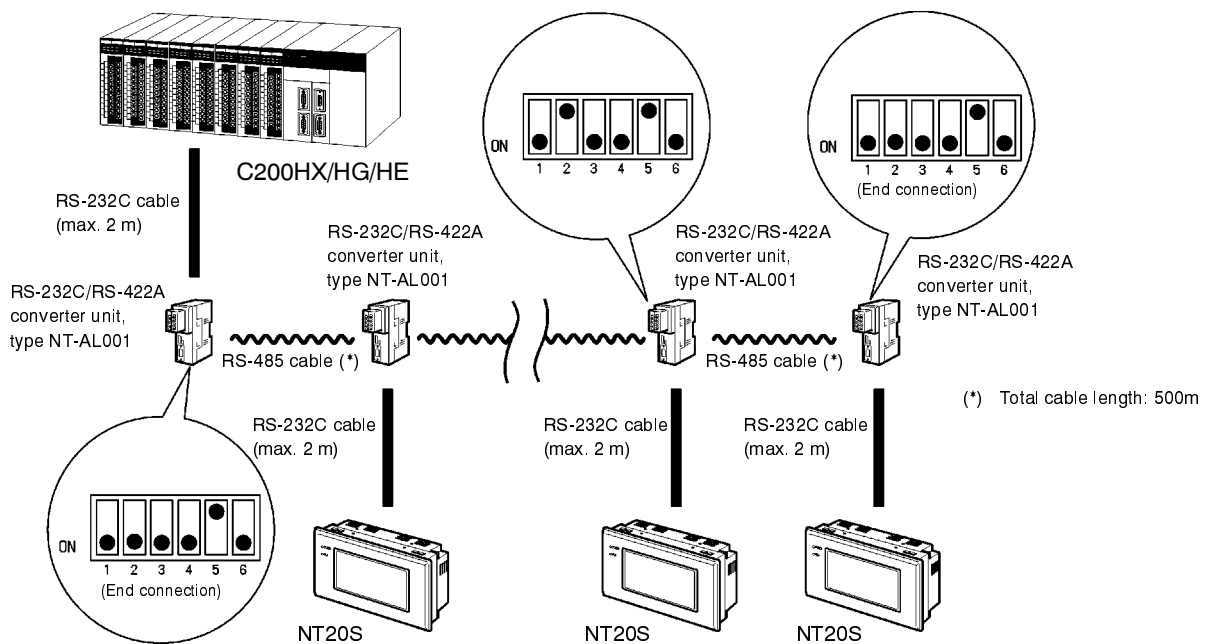

• RS-422A connection, RS-422A at the PC side

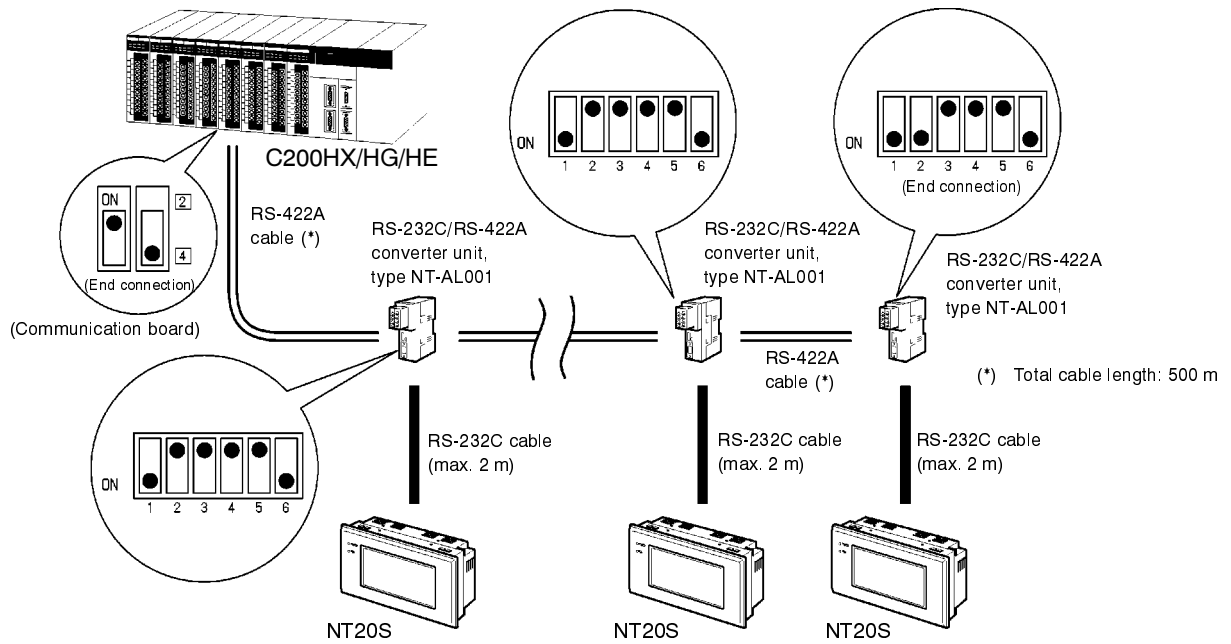

RS-485 connection, RS-485 at the PC side

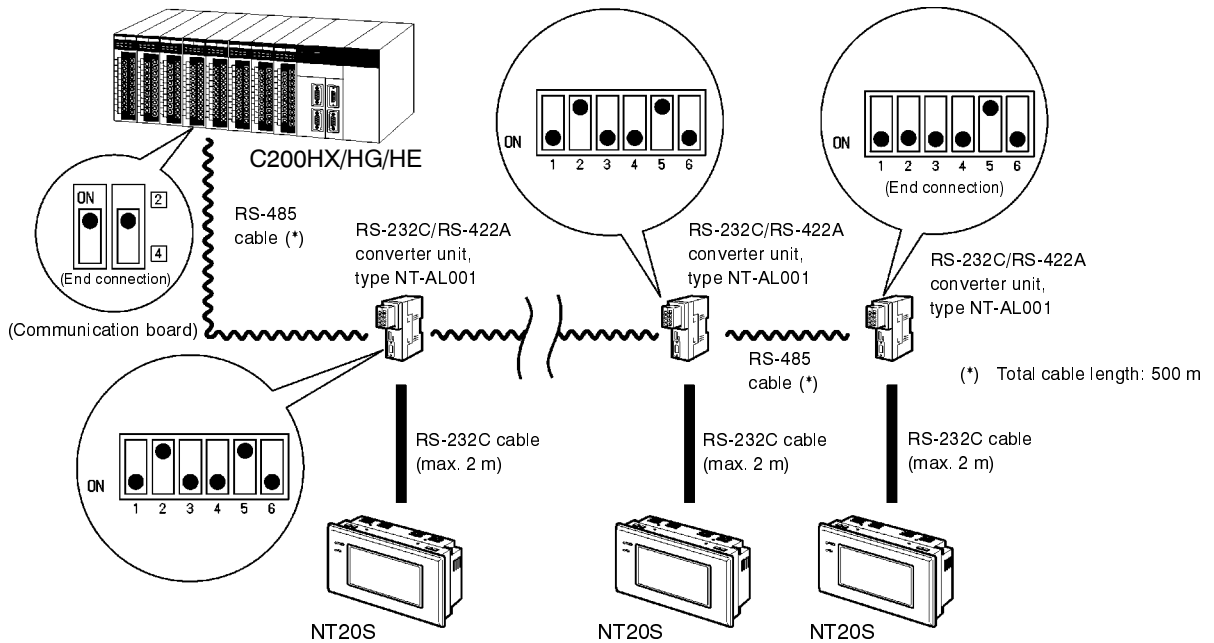

2-6-3 PC Switch Settings

When the PC and NT20S units have been connected, set the switches at the CPU module at the PC side in order to enable communication using the NT link method.

- C series, C200HX/HG/HE

Write the communication conditions directly to the “PC system area” (data memory) using a peripheral tool (e.g., SYSMAC support software). For details on the operation for setting the “PC system area”, refer to the “SYSMAC C200HX/HG/HE Installation Guide” (W302-E1-□).

[PC system setting area setting]

With C200HX/HG/HE, the setting area differs according to which port among the standard port of the CPU unit and the port of the expansion communication board is used for the connection.

Port	Channel #	Witing Value	Settings
C200HX/HG/HE RS-232C port	DM6645	5□00	Use NT link (1:N) □ = highest unit No. in the maximum number of connectable PTs (1 to 7). (*)
C200HX/HG/HE port A	DM6555		
C200HX/HG/HE port B	DM6550		

(*) When using C200HE, the PT unit No. range is 1 to 3.

2-7 Communicating with the PC Using C200H Direct Communication

Connect an NT20S-ST122-V1 and PC made by OMRON with an I/O cable.

2-7-1 Applicable PC Units

Before making the connection, check the series and model of the PC to which the connection is to be made. A list of the PCs that can be connected to an NT20S using C200H direct communication is presented below.

CPU Unit	Model Name
C20H/C28HC40H/C60H	C□□H
C200H-CPU01-E	C200H
C200H-CPU03-E	
C200H-CPU11-E	
C200H-CPU21-E	
C200H-CPU23-E	
C200H-CPU31-E	
C200HS-CPU01-E	C200HS
C200HS-CPU03-E	
C200HS-CPU21-E	
C200HS-CPU23-E	
C200HS-CPU31-E	
C200HS-CPU33-E	C200HE
C200HE-CPU11-E	
C200HE-CPU32-E	
C200HE-CPU42-E	C200HG
C200HG-CPU33-E	
C200HG-CPU43-E	
C200HG-CPU53-E	
C200HG-CPU63-E	C200HX
C200HX-CPU34-E	
C200HX-CPU44-E	
C200HX-CPU54-E	
C200HX-CPU64-E	

 **Caution:**

With systems in which the user program operates in accordance with the PC cycle time, since there is some fluctuation in the PC cycle time, the system operation may not be consistent, and this should be born in mind when designing the system.

2-7-2 Connection Method

Connect the NT20S and PC.

The connection conditions are different for C200H/HS, C200HX/HG/HE and C□□H.



Caution:

- Always turn off the power at the PC and PT before connecting the C200H interface cable. Otherwise the system may operate unpredictably.
- After connecting the communication cable, always secure it with the screws. Otherwise the cable may disconnect, causing operation to fail.

[I/O connection cable]

Use the following models of I/O connection cable.

	Model	Cable Length (L)
For connecting C200H/HS/HE/HG/HX	C200H-CN311	30 cm
	NT20M-CNP711 C200H-CN711	70 cm
	NT20M-CNP221 C200H-CN221	2 m
	NT20M-CNP521 C200H-CN521	5 m
	NT20M-CNP131 C200H-CN131	10 m
For connecting C□□H	C20H-CN312	30 cm
	NT20M-CNP712 C20H-CN712	70 cm
	NT20M-CNP222 C20H-CN222	2 m

* The C200H interface side connector of NT20M-CNP□□□ has been downsized.



Caution:

- Keep the total length of I/O cables used within 12 m (6 m for C□□H).
- The cable's tensile load is 30 N. Do not subject it to loads greater than this. Otherwise a discontinuity may occur, causing operation to fail.

Reference:

If a C200H-CN□□□ or C20H-CN□□□ is used as the I/O connection cable, the connector will project beyond the bottom face of the NT20S. If the I/O cable is passed through a hole or other opening, the hole or opening must be at least 53 mmφ. Removing the top cover reduces this requirement to 33 mmφ or larger. During installation, this cover must be replaced before securing the PT.

Connection to C200H/C200HS and C200HX/HG/HE

Connect the CPU unit or I/O extension unit with an I/O cable. The following restrictions apply when making this connection.

- A maximum of one CPU unit and one I/O extension unit can be connected. Connection to two I/O extension units is not possible.
- Connection to a remote I/O slave station is not possible.
- There is only one C200H interface unit interface connector. This means that it is not possible to connect an NT20S between a CPU unit and an I/O extension unit. It must be the final connection in the system.

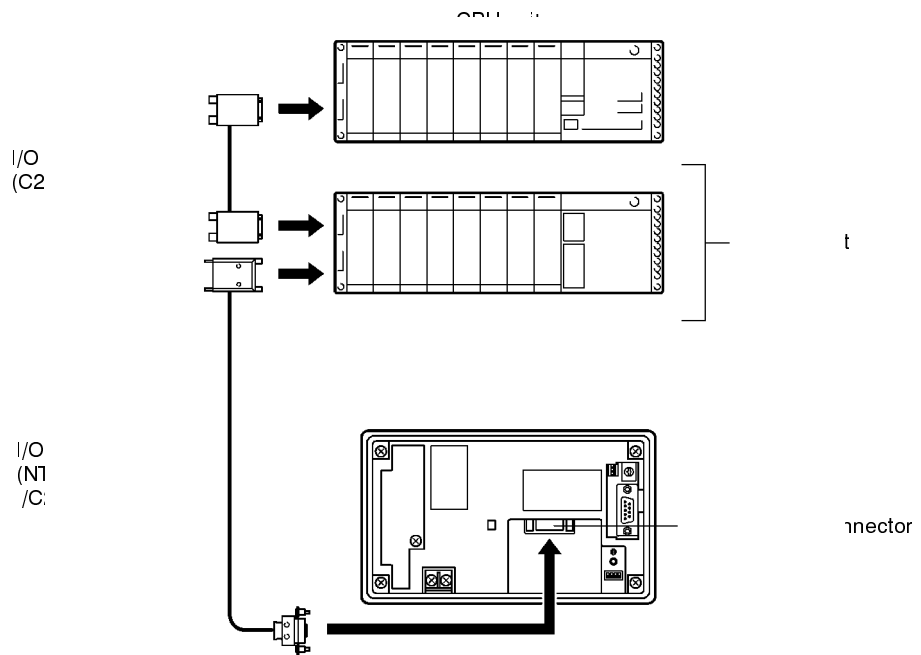

Connection to C□□H

Connect the CPU unit with an I/O connection cable. The following restrictions apply when making this connection.

- A maximum of one CPU unit can be connected.
- Up to two I/O units can be connected for the one CPU unit, but I/O extension units cannot be connected.
- It is not possible to connect a C□□H I/O unit after the NT20S. It must be the final connection in the system.

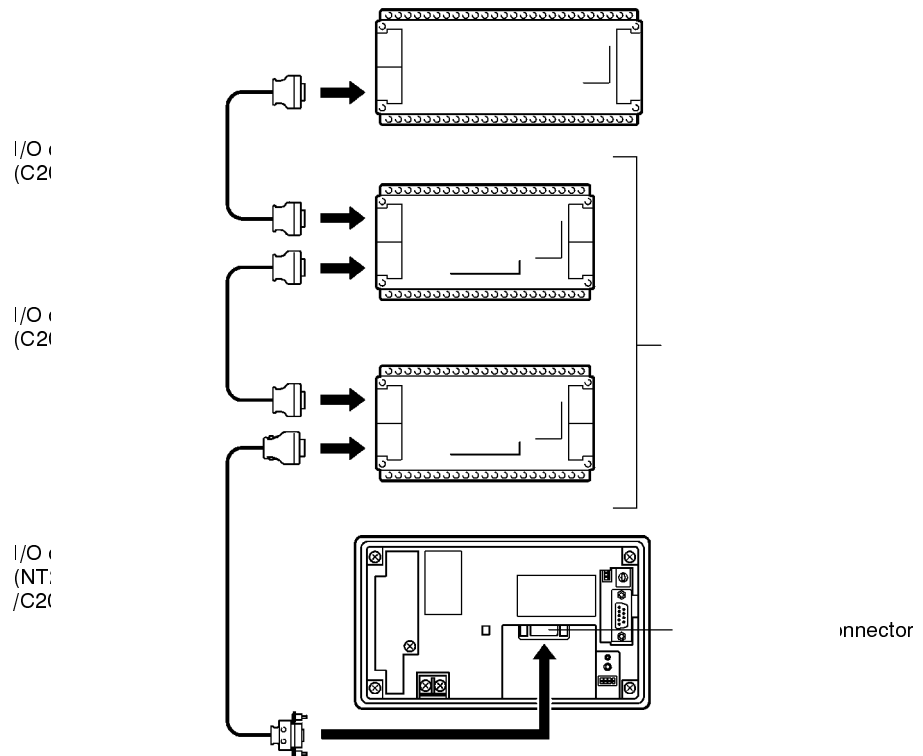

Note: When connecting a C□□H, always install a noise filter.

1. Insert the noise filter in the power supply line of the C□□H.
2. Make the distance between the noise filter and the C□□H as short as possible and separate it from the power supply line.
3. Install the noise filter case on the FG face.
4. Use a ZGB2202-01U (manufactured by TDK) or equivalent as the noise filter.

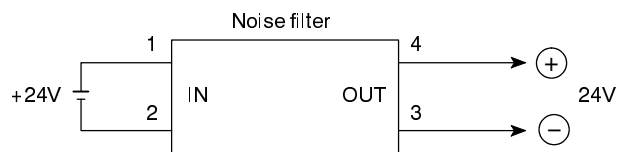

2-7-3 Switching the Power ON/OFF When Using C200H Direct Communication

The NT20S-ST122-V1 functions as an I/O extension unit of the PC. Use the following procedure to switch the power ON and OFF.

Caution: Depending on the method used to switch the power ON and OFF, the entire system may stop. Follow the procedure described below to switch the power ON and OFF.

Power ON

Switch the power ON as follows:

[NT20S power ON] “Connecting to Host” is displayed on the NT20S screen.



[PC power ON] After “Connecting to Host” has been displayed for approximately 1 second, normal operation starts.

- Note:**
- If the power to the PC is switched on first, the CPU of the PC is subjected to a system reset, making operations such as programming console impossible. Then, when the power to the NT20S is switched on, “Connecting to Host” is displayed on the NT20S screen for approximately 1 second, after which normal operation starts.
 - If the I/O connection cable is disconnected during system operation, an I/O bus error occurs at the PC side and operation stops. If this happens, connect the I/O connection cable and cancel the error.

Power OFF

Switch the power OFF as follows:

[Switch the power supplies to the PC and NT20S off simultaneously] The next time the power is switched ON, the NT20S displays the screen that was displayed when the power was switched OFF.

- Note:**
- If the power to the NT20S is switched off first, the CPU of the PC is subjected to a system reset, making operations such as programming console impossible.
 - Switch off the system temporarily before replacing the NT20S (when a fault occurs, for example). If the power to the NT20S only is switched off, the system stops immediately and this could cause an accident or damage machinery.

2-8 Host Connections by RS-232C

Connect NT20S-ST128 with an RS-232C Interface Unit installed to the host computer with an RS-232C cable.

RS-232C connection allows a single NT20S to be connected to the host.

A computer or other control device with a built-in RS-232C interface is a suitable host for connection to the NT20S.

2-8-1 Host Computer Communication Settings

Set the host communication conditions according to the following table.

Item	Setting
Baud rate	Set to the same baud rate as the NT20S: 2400, 4800, 9600, 19200
Data bits	7 bits/8 bits
Stop bits	1 bit/2 bits
Parity	Even, Odd, None
Flow control	RS/CS control XON/XOFF control None

Note: Set the same communication conditions at the NT20S and Host.

Refer to the appropriate instruction manuals for the method of setting the Host communication conditions.

Set to the maximum baud rate supported by both the NT20S and Host.

The communication condition settings of the NT20S-ST128 are set with the RS-232C communication conditions memory switches. For details, refer to "Setting RS-232C Communication Conditions" on page 82.

2-8-2 Connector Pin Arrangement

The RS-232C connection between the NT20S and Host is described below.

NT20S Interface Unit

The connector specification is described below.

Electrical characteristics: Conforms to EIA RS-232C specifications.

Signal direction: Signal input and output are relative to the host computer.

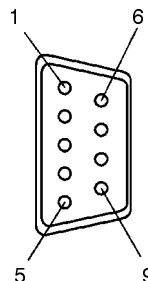

Connector pin #	Signal name	Abbreviation	Signal direction
			NT20S ← → Host
2	Send data	SD (TXD)	→
3	Receive data	RD (RXD)	←
4	Request to send	RS (RTS)	→
5	Clear to send	CS (CTS)	←
6	+5 V output, max. 150 mA	+5V	→
9	Signal ground	SG (GND)	—

* Unlisted pins are not used.

Note: For cable parts and the wiring method, refer to APPENDIX G Method for Making the Cable for Connection to the Host (page 256).

Connecting to the Host Computer

Use a cable that is compatible with the RS-232C connector of the host to connect the NT20S and the host (see the example in the figure below).

In the example shown here, the cable connects the 9-pin connector of the NT20S and 25-pin connector of the host. If the host has a 9-pin RS-232C connector, use an RS-232C cable with 9-pin connectors at both ends.

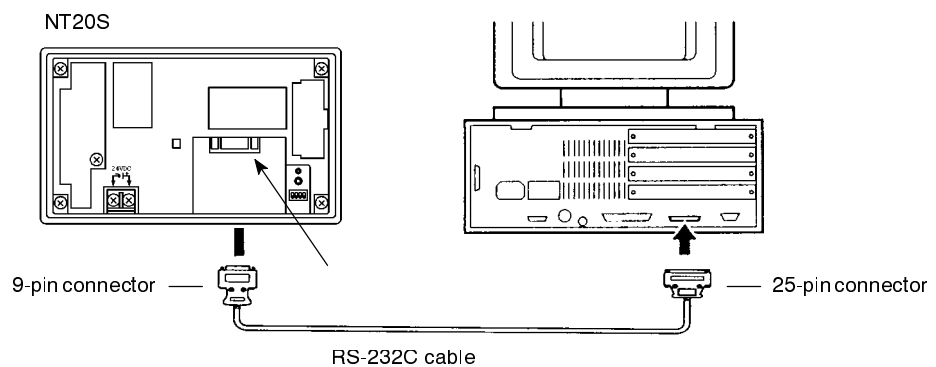

- Caution:**
- When making the connection, switch off the power to the NT20S and PC before disconnecting or connecting any connector.
 - After connecting the communication cable, always secure it with the screws. Otherwise the cable may disconnect, causing operation to fail.

Note: If using the +5 V supply of pin No.6, check first that the equipment that is to receive the supply has a current capacity no greater than 150 mA. The +5 V output of the NT20S is +5 V DC \pm 5%, max. 150 mA.

SECTION 3

System Menu Operation

This section describes the operation of the System Menu focusing on the procedure to start up the NT20S.

Functions which will be convenient to use the NT20S and those which are useful for the system maintenance are also explained here.

3-1	Operation Flow by the System Menu	66
3-2	Starting the NT20S	67
3-2-1	Changing the System Settings etc.	67
3-3	Operation Modes and the System Menu	68
3-3-1	System Menu and the Operation Modes	68
3-3-2	Menu Tree	69
3-3-3	Operations with the System Menu	70
3-4	Initializing Memory	72
3-4-1	Initialization by Using the System Menu	72
3-4-2	Initialization by Using the DIP Switch (Forced Initialization)	74
3-5	Setting the Conditions of Communications with the Host by Using the Memory Switches	75
3-5-1	Selecting the Host Communication Method (NT20S-ST121-EV3 only)	78
3-5-2	Selecting the Host Link Communication Speed (NT20S-ST121-EV3 only)	79
3-5-3	Selecting Unit Numbers (NT20S-ST121-EV3 only)	80
3-5-4	Setting RS-232C Communication Conditions (NT20S-ST128)	82
3-5-5	Selecting the Automatic Reset Function	84
3-6	Registering the Screen Data	86
3-7	Starting the Operation	90
3-8	Various System Settings	91
3-8-1	Setting the Key Press Sound	91
3-8-2	Using the Buzzer	92
3-8-3	Backlight OFF Function	94
3-8-4	Support Tool Mode Setting (NT20S-ST121-EV3/ST122-V1 Only)	95
3-8-5	Lamp Bit Control (NT20S-ST128)	97
3-9	System Maintenance	99
3-9-1	I/O Check	99
3-9-2	Checking the PT Setting	107
3-9-3	Checking the NT20S DIP Switch Settings	109

3-1 Operation Flow by the System Menu

Follow the procedure below when using the NT20S for the first time or when changing the system.

Create the Screen Data

Create the screen data to be displayed on the NT20S by using a support tool.

For the screen data creation, refer to the “NT-series Support Tool Operation Manual” (V028-E1-□).

Start Up the NT20S (Display the System Menu.) (page 68)

Turn ON the power to the NT20S.

When no screen data has been registered, the “SYSTEM MENU” will be displayed. If the NT20S enters the RUN mode, press appropriate touch switches to display the System Menu.

Initializing Memory (page 72)

Select a System Menu and initialize the NT20S unit memory.

Memory Switch Settings (page 75)

Select the System Menu and make settings such as the communication conditions for communication with the Host by setting the memory switches.

Registering the Screen Data (page 86)

Connect a support tool to the NT20S and transfer the screen data from the support tool to the NT20S.

For the connection of a support tool, refer to Section 2-3 Connecting to the Support Tool. (page 31)

Starting the Operation (page 90)

Connect to the PC/Host and start the operation.

System Maintenance (page 99)

If an error has occurred during operation, check the I/Os, settings, etc. referring to this guide.

3-2 Starting the NT20S

When the NT20S is started, it will enter the RUN mode if system settings and screen data registration have been completed. If no screen data has been registered or the screen data are destroyed, the System Menu will be displayed.

Before turning ON the power, check the following DIP switch settings on the NT20S.

- SW2-3 “Switch to the System Menu enabled/disabled” is set to OFF (enabled).
- SW2-1 “Screen data forced initialize Yes/No” is set to No (ineffective).

For the DIP switch settings of the unit, refer to the “DIP switch settings” (page 24).

3-2-1 Changing the System Settings etc.

Follow the procedure below to change the system settings or screen data contents.

- Procedure** 1. Turn ON the power to the NT20S.

The NT20S will enter the RUN mode and the start-up screen will be displayed. The start-up screen varies according to registered screen data.

2. Press appropriate touch switches to display the System Menu, and change system settings. For the method for calling the System Menu, refer to the “Operations with the System Menu” (page 70).

Note: If the NT20S has failed to start up normally; an error message is displayed or no screen is displayed, memory needs to be initialized.

For the memory initializing procedure, refer to Section 3-4 Initializing memory (page 72).

3-3 Operation Modes and the System Menu

The NT20S operates in either “RUN”, “Transmit”, or “Maintenance” mode. The operation modes can be switched by using the System Menu.

3-3-1 System Menu and the Operation Modes

Select an operation mode by pressing the corresponding touch switch in the System Menu. The operation modes with respect to the System Menu are related to each other as shown below.

For the operations with the System Menu, refer to the “Operations with the System Menu” (page 70).

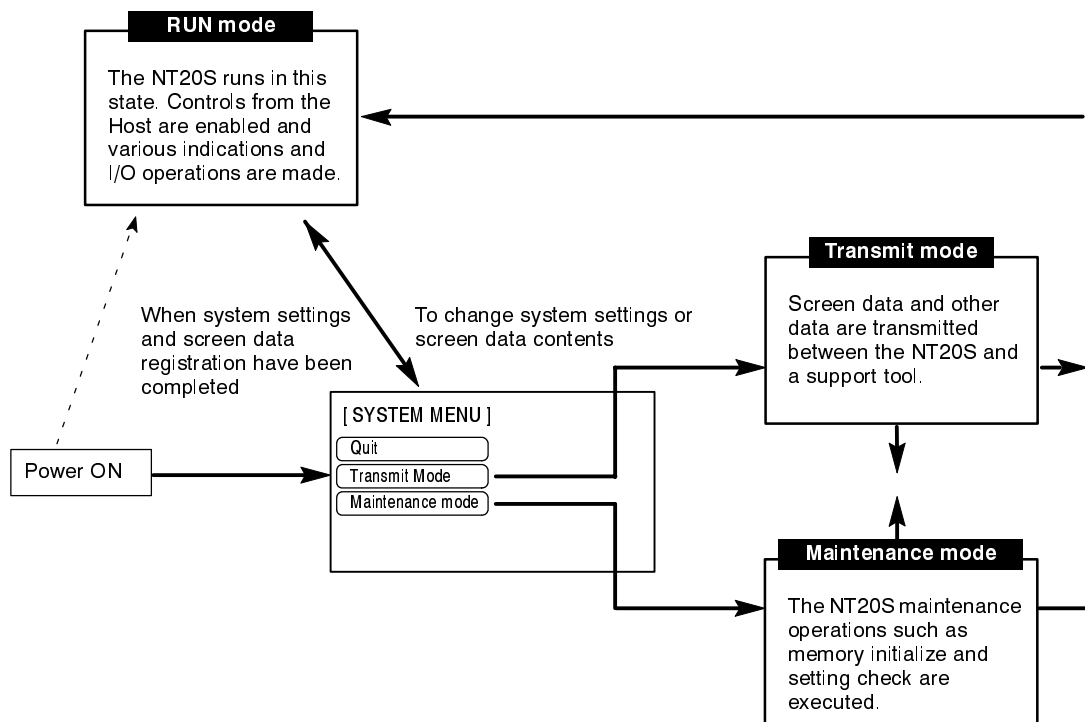

3-3-2 Menu Tree

The System Menu allows to effect various NT20S functions by using the touch switches. The NT20S's functions with respect to the System Menu are related as shown below.

For the operations with the System Menu, refer to the "Operations with the System Menu" (page 70).

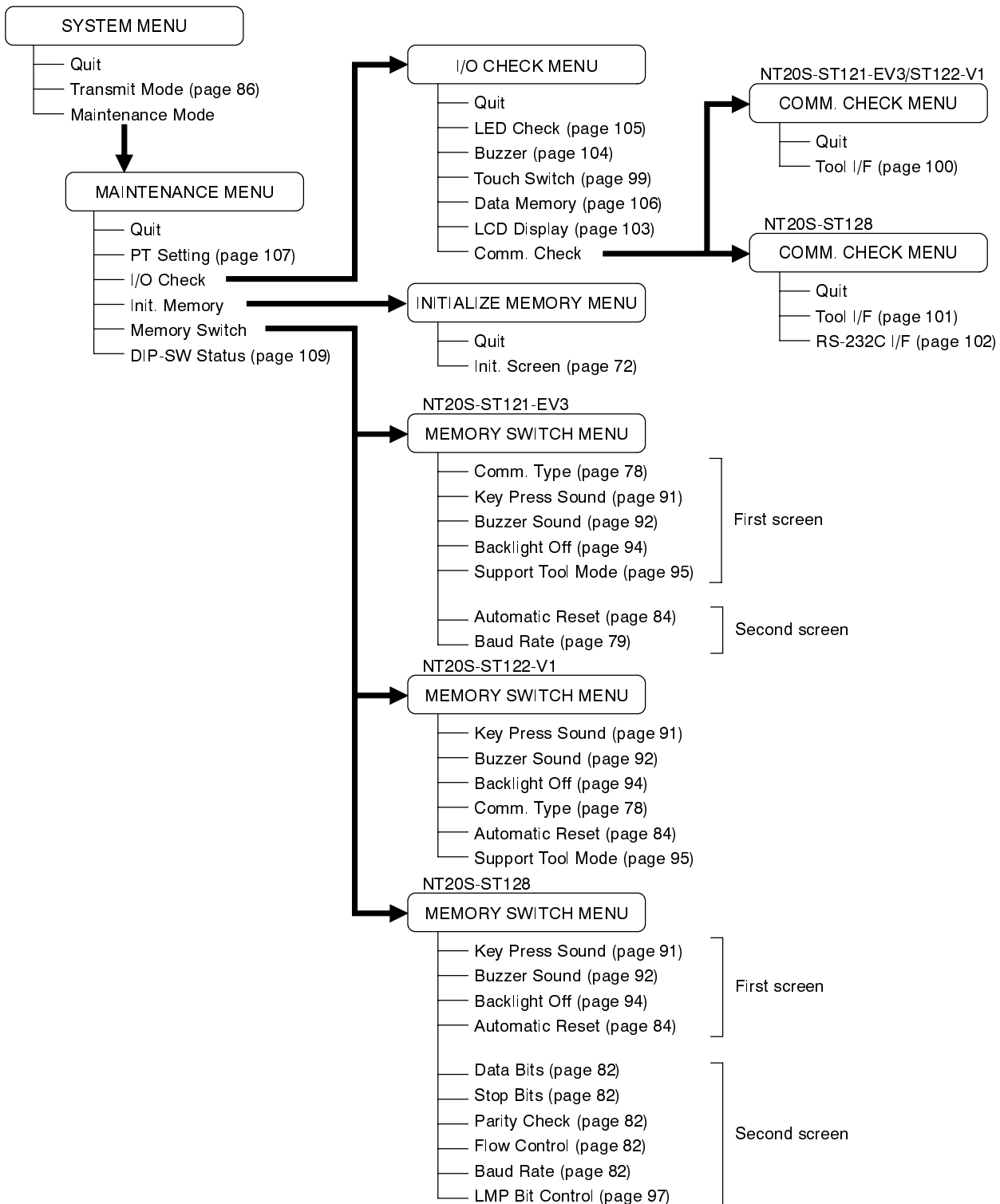

3-3-3 Operations with the System Menu

The following gives the procedure to call the System Menu, select the menu items, and other operations with the System Menu.

Make sure that DIP SW2-3 “Switch to the System Menu enabled/disabled” is set to OFF (enabled). If the setting is ON (disabled), the System Menu will not be displayed by following the procedure given below.

Displaying the System Menu Press appropriate touch switches to display the System Menu as mentioned below. The “RUN” LED goes off when the System Menu is displayed.

The NT20S display screen has four touch switches to display the System Menu in the four corners (about 8 mm x 8 mm size). Press any two of these switches at the same time to call the System Menu screen.

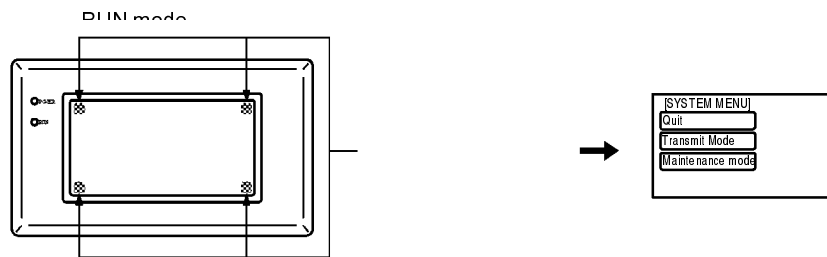

Note that the touch switches used to call the System Menu are not displayed on the screen. If a touch switch displayed in a corner is pressed first, the touch switch will function and the System Menu will not be displayed. To successfully call the System Menu, first press a corner where no touch key is displayed, and then, press any other corner regardless of the presence of a touch key.

If a screen has the touch switches registered at all of the four corners, it is impossible to call the System Menu from the screen.

A “system key” function can be assigned to a touch switch. Pressing the touch switch so assigned on the screen can easily display the System Menu. For the relationship between the system key and the touch switch, refer to the “System key functions” (page 139).

Selecting the Menu Items

Press (touch) a menu item on the screen to select the item.

Menu items allow to make the ON/OFF selection or to call subsequent menu or screen.

Example 1

To call the “Maintenance mode menu” by pressing the “Maintenance Mode” on the System Menu screen:

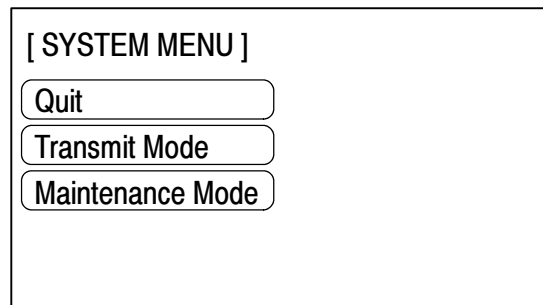

Select “Maintenance Mode”.

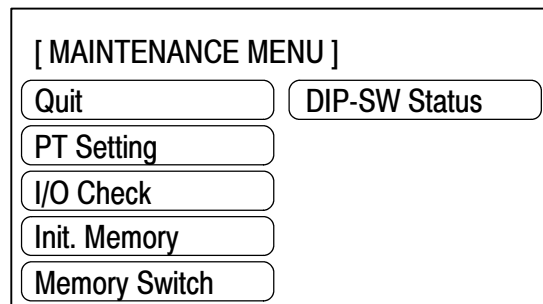

System Menu Items

The System Menu items and the functions are as given below.

Menu Item	Function
Quit	The System Menu screen is cleared and the NT20S will return to the RUN mode.
Transmit Mode	The Transmit Mode screen will be displayed to allow the transmission of the screen data between the NT20S and the support tool. For the transmission of the screen data, refer to Section 3-6 Registering the Screen Data (page 86).
Maintenance Mode	The MAINTENANCE MENU will be displayed to allow the maintenance of the NT20S system.

Switching from the System Menu to the RUN mode

The NT20S will exit the System Menu and switch to the RUN mode in the cases mentioned below.

- Selecting “Quit” in the System Menu.
- The screen (touch switches) is not pressed for over 10 seconds.

3-4 Initializing Memory

If the NT20S is used for the first time or if the screen data is ruined and the NT20S cannot be normally started, the memory needs to be initialized.

The memory initialization is required in the cases mentioned below.

- When the NT20S is used for the first time or when an error message indicating that the screen data is ruined etc. when the NT20S is started.
 - ➔ Use the “Maintenance Mode” – “Init. Memory” in the System Menu.
- When the NT20S has made a buzzer sound and the screen has disappeared during the start-up or operation.
 - ➔ Use the NT20S DIP SW2-1 “Screen data forced initialize Yes/No”.

When an error has occurred, the error messages such as “Screen data corrupted” will be displayed. For the error messages displayed on the screen, refer to Section 7-2 “Responding to Displayed Error Messages” (page 237).

Note: Initializing the screen data memory will erase entire screen data registered in the NT20S. Make sure that there are backup copies of the screen data on floppy disks before starting the initialization.

- Data of the NT20S to be initialized
 - Screen data
 - System memory
 - Memory table
 - Mark data
 - Direct information (NT20S-ST121-EV3/ST122-V1)

3-4-1 Initialization by Using the System Menu

Initialize the screen data memory by following the procedure given below.

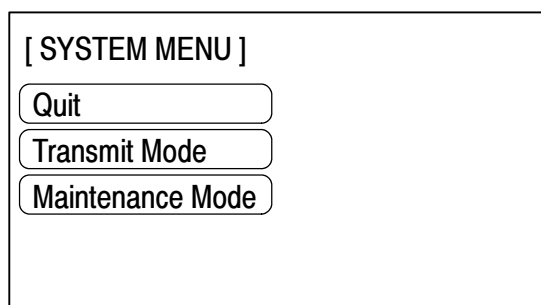

Select “Maintenance Mode”.



[MAINTENANCE MENU]

Quit DIP-SW Status

PT Setting

I/O Check

Init. Memory

Memory Switch

Select "Init. Memory".



[INITIALIZE MEMORY MENU]

Quit

Init. Screen

Select "Init. Screen".



Initialize Screen Memory?

Yes

No

Select "Yes".

The screen data memory is initialized. During the initialization, the "Initializing" message will be displayed.

If "No" is selected, the memory initialization will be canceled and the NT20S returns to the "operation mode".



No direct information is set!

Use the Support Tool
to set the PT Control Area
and PT Notify Area

Example:

NT20S-ST121-EV3/ST122-V1
Direct information is also initialized. Set the direct information with the support tool.

After initialization of the screen data memory, the system enters the operation mode. At this point, nothing is displayed on the screen of the NT20S. Return to the System Menu, select the Transmit Mode, and transmit the screen data from the support tool.

If the screen data cannot be initialized for any reason, the message "An Error Occur Initializing Memory" is displayed.

3-4-2 Initialization by Using the DIP Switch (Forced Initialization)

Note: Be sure to turn the power OFF before setting the NT20S DIP switch.

Set the DIP switch as follows to initialize the screen data memory.

- Operation** 1. Set DIP SW2-1 on the NT20S to ON and turn the power ON or reset the NT20S.

Initialize Screen Memory?

Select "Yes".
The screen data memory is initialized. During the initialization, the "Initializing" message will be displayed.



Initialized the
Screen Data Memory.

Turn OFF the DIP Switch 2-1
and push the Reset Switch,
then return to RUN mode.

2. Turn the NT20S power to OFF.
3. Set NT20S DIP SW2-1 to OFF and turn the power ON.

- Reference:**
- Selecting "No" will cancel the memory initialization. In either case, when changing the system settings or registering screen data, display the system menu after setting DIP switch SW2-1 to the OFF position while the NT20S power is OFF, then switching the power back ON.
 - The NT20S DIP SW2-1 is used to set "Screen data forced initialize Yes/No". Setting this to Yes selects "effective", and No "ineffective".

3-5 Setting the Conditions of Communications with the Host by Using the Memory Switches

The communications between the NT20S and a PC/Host are called the host communications.

The NT20S models can be connected to the host using the following communication methods.

- NT20S-ST121-EV3 :Host link or NT link (both direct connection)
- NT20S-ST122-V1 :C200H direct communication (direct connection)
- NT20S-ST128 :RS-232C communication (command control)

With NT20S-ST121-V3, the host link, NT link (1:1), and NT link (1:N) communication methods are set with memory switches. Other settings such as baud rate and automatic resetting of communication are also set with memory switches.

This section describes the communications condition settings by using the memory switches.

Memory Switches

The NT20S has the memory areas used to store the PC connection method, communications conditions, system settings, etc. which can be used as the switches and called the "memory switches". Since the memory switches use the flash memory, the stored data can be held even when the power supply is turned OFF.

Setting Functions and the Memory Switch Menu

The memory switches can be set easily by using the memory switch menu in the System Menu.

The following settings can be made with the memory switches. Refer to the subsequent pages and Section 3-8 Various System Settings for the details of each setting and function.

[When using NT20S-ST121-EV3, host link/NT link]

Host link method

MEMORY SW MENU (1/2)		Quit
Comm. Type	Host Link	Page
Key Sound	OFF	↓
Buzzer Sound	OFF	WRT& EXIT
Bk light Off	None	
Tool Mode	NT20M	

MEMORY SW MENU (2/2)		Quit
Automatic Reset	No	Page
Baud Rate	9600bps	↑
		WRT& EXIT

NT Link method (1:1)

MEMORY SW MENU (1/2)		Quit
Comm. Type	NT Link	Page ↓
Key Sound	OFF	
Buzzer Sound	OFF	WRT& EXIT
Bk light Off	None	
Tool Mode	NT20M	

MEMORY SW MENU (2/2)		Quit
Automatic Reset	No	Page ↑
		WRT& EXIT

NT Link method (1:N)

MEMORY SW MENU (1/2)		Quit
Comm. Type	NT Link (1:N)	Page ↓
Key Sound	OFF	
Buzzer Sound	OFF	WRT& EXIT
Bk light Off	None	
Tool Mode	NT20M	

MEMORY SW MENU (2/2)		Quit
Automatic Reset	No	Page ↑
Unit No.	7	
		WRT& EXIT

- Key Press Sound 3-8 Various System Settings (page 91)
- Buzzer Sound 3-8 Various System Settings (page 92)
- Backlight Off 3-8 Various System Settings (page 94)
- Comm. Type Selecting the Host Communication Method (page 78)
- Baud Rate Selecting the Host Link Communication Speed (page 79)
- Automatic Reset Selecting the Automatic Reset Function (page 84)
- Tool Mode 3-8 Various System Settings (page 95)

[NT20S-ST122-V1 C200H]

Key Sound	ON	Quit
Buzzer Sound	ON	
Bk light Off	10min	WRT& EXIT
Comm. Type	C200H	
Automatic Reset	Yes	
Tool Mode	NT20S	

- Key Press Sound 3-8 Various System Settings (page 91)
- Buzzer Sound 3-8 Various System Settings (page 92)
- Backlight Off 3-8 Various System Settings (page 94)
- Comm. Type Fixed as "C200H"
- Automatic Reset Selecting the Automatic Reset Function (page 84)
- Tool Mode 3-8 Various System Settings (page 95)

[NT20S-ST128 RS-232C]

Key Press Sound	ON	Quit	Data Bits	8bits	Quit	
Buzzer Sound	ON		Stop Bits	1bit		
Bk light Off	10min		Page	Parity Check	Even	Page
Automatic Reset	Yes		↓	Flow Control	RS/CS	
WRT& EXIT			Baud Rate	19200bps	WRT& EXIT	
			LMP Bit Control	Enable		

- Key Press Sound 3-8 Various System Settings (page 91)
- Buzzer Sound 3-8 Various System Settings (page 92)
- Backlight Off 3-8 Various System Settings (page 94)
- Automatic Reset Selecting the Automatic Reset Function (page 84)
- Data Bits Setting RS-232C Communication Conditions (page 82)
- Stop Bits Setting RS-232C Communication Conditions (page 82)
- Parity Check Setting RS-232C Communication Conditions (page 82)
- Flow Control Setting RS-232C Communication Conditions (page 82)
- Baud Rate Setting RS-232C Communication Conditions (page 82)
- LMP Bit Control 3-8 Various System Settings (page 97)

3-5-1 Selecting the Host Communication Method (NT20S-ST121-EV3 only)

The NT20S-ST121-EV3 can be connected to a PC by the host link or the NT link. Either link can be selected by setting the “Comm. Type” memory switch. The factory setting has been made to the “Host link”.

Select the host communication method by the menu operation from the System Menu as mentioned below.

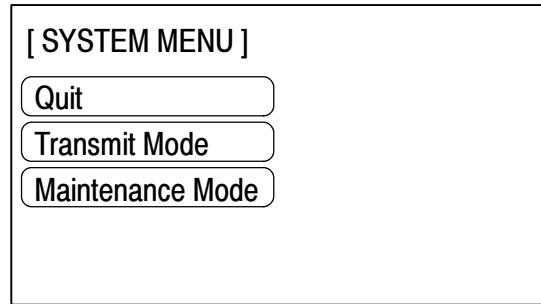

Select “Maintenance Mode”.

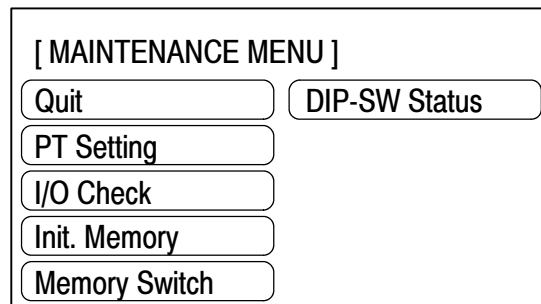

Select “Memory Switch”.

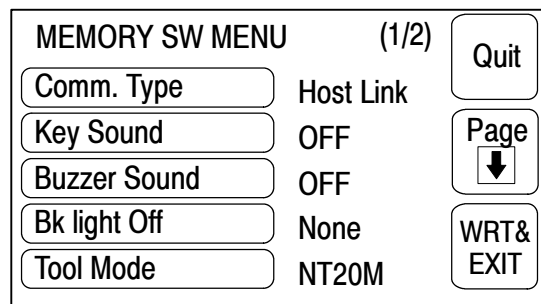

Repeatedly pressing the “Comm. Type” touch switch causes the setting to cycle through the options “Host link”, “NT link”, and “NT Link 1:N”, in that order.

To set and quit the menu, press the [WRT&EXIT] touch switch. To quit without setting, press [Quit].

Reference: The communication method must be selected according to the method that the connecting PC supports.

3-5-2 Selecting the Host Link Communication Speed (NT20S-ST121-EV3 only)

When using the NT20S-ST121-EV3 with the host link, the baud rate of the communications with the PC can be set. Use the "Baud Rate" switch and select 9600 bps or 19200 bps.

The factory setting has been made at 9600 bps.

Select the baud rate of the communication with the PC by the menu operation from the System Menu as mentioned below.

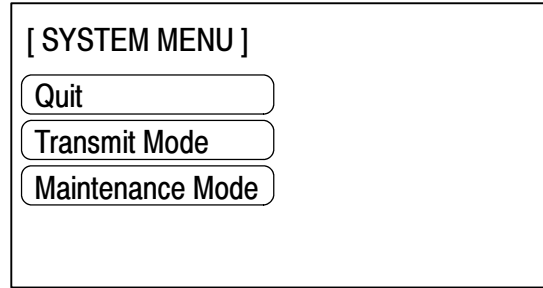

Select "Maintenance Mode".

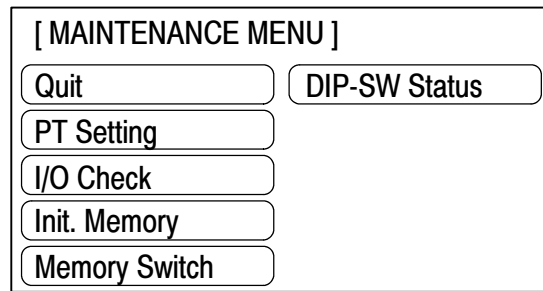

Select "Memory Switch".

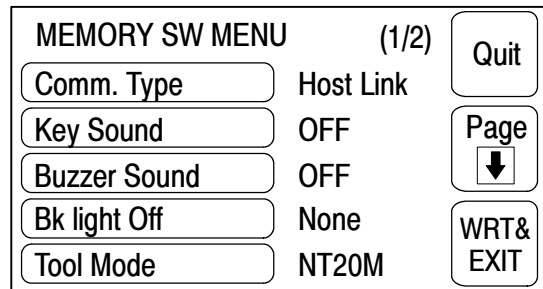

Select "Page".

If the host link is not selected, press the "Comm. Type" touch switch and select "Host link".

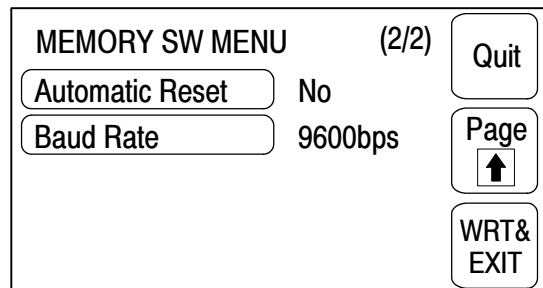

Each time the "Baud Rate" touch switch is pressed, the setting option alternates between "9600 bps" and "19200 bps".

To set and quit the menu, press the [WRT&EXIT] touch switch. To quit without setting, press [Quit].

3-5-3 Selecting Unit Numbers (NT20S-ST121-EV3 only)

When using NT20S-ST121-EV3 with the NT link (1:N) communication method, set unit numbers.

When using NT link (1:N), unit numbers are used to identify each of the multiple PTs connected to a single PC port. Set a different unit number for each of the PTs connected to the port.

The unit numbers that can be set differ in accordance with the type of host PC as follows.

C200HE :Unit Nos. 0 to 3
 C200HG, C200HX :Unit Nos. 0 to 7

Set the unit numbers by following the menu operation from the System Menu described below.

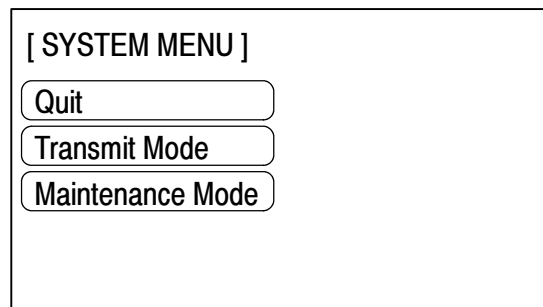

Select "Maintenance Mode".

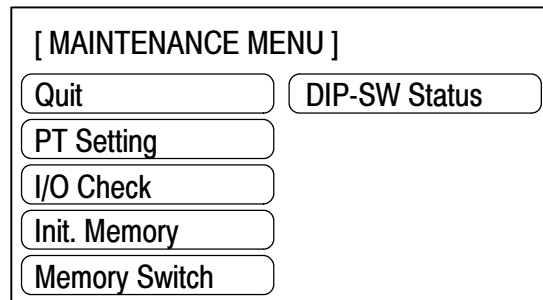

Select "Memory Switch".

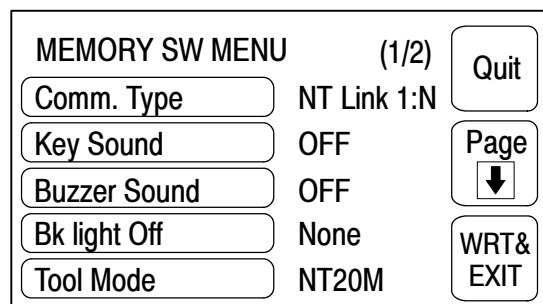

Press the "Comm Type" touch switch to select "NT link (1:N)". Select "Page".



MEMORY SW MENU (2/2)		Quit
Automatic Reset	No	Page
Unit No.	7	↑
		WRT& EXIT

Repeatedly pressing the "Unit No." touch switch cycles through the numbers that can be set.

To set and quit the menu, press the [WRT & EXIT] touch switch. To quit without setting, press [Quit]. The run mode will be established.

3-5-4 Setting RS-232C Communication Conditions (NT20S-ST128)

When using an NT20S-ST128 (using the RS-232C interface for communication with the host), set the following communication conditions.

- Data Bits
- Stop Bits
- Parity Check
- Flow Control
- Baud Rate

Set the same communication conditions at the host and the NT20S. You are recommended to set the highest baud rate that can be used by the host and NT20S.

The factory settings are as follows:

- Data Bits 8bits
- Stop Bits 2bits
- Parity Check Even
- Flow Control None
- Baud Rate 9600bps

Set the conditions of the communication with the Host by the menu operation from the System Menu as mentioned below.

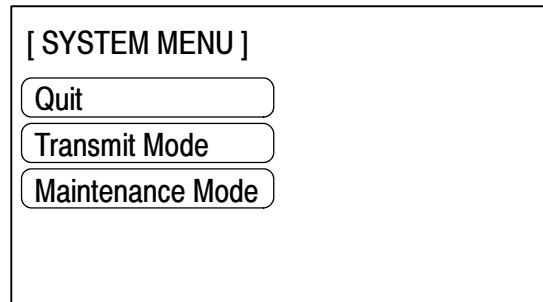

Select "Maintenance Mode".

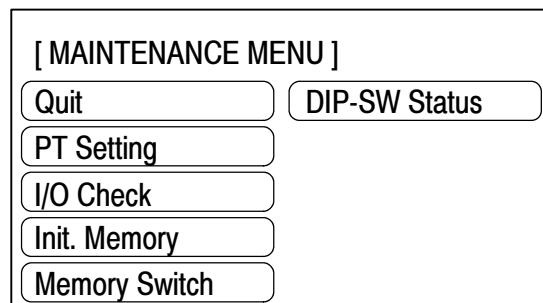

Select "Memory Switch".



Key Press Sound	ON	Quit
Buzzer Sound	ON	
Bk light Off	10min	Page
Automatic Reset	Yes	↓
		WRT& EXIT

Select "Page down".



Data Bits	8bits	Quit
Stop Bits	1bit	
Parity Check	Even	Page
Flow Control	RS/CS	↑
Baud Rate	19200bps	WRT& EXIT
LMP Bit Control	Enable	

➔ The selected option displayed when the corresponding touch switch is pressed: the options for each switch are indicated below:

- Data Bits 7bits / 8bits
- Stop Bits 1bit / 2bits
- Parity Check None / Even / Odd
- Flow Control None / RS/CS / XON/XOFF
- Baud Rate 2400bps / 4800bps / 9600bps / 19200bps
- LMP Bit Control Enable / Disable

Note: Use the same condition settings as set for the host. It is recommended that the highest baud rate possible is selected for both the host and the NT20S.

➔ For details on lamp bit control, refer to Section 3-8 "Various System Settings" on page 91.

3-5-5 Selecting the Automatic Reset Function

The “Automatic Reset” memory switch is used to set whether or not the communication is automatically reset after the occurrence of a communication error.

The factory setting has been made at “No”.

Select the baud rate of the communication with the PC by the menu operation from the System Menu as mentioned below.

[SYSTEM MENU]

Quit

Transmit Mode

Maintenance Mode

Select “Maintenance Mode”.



[MAINTENANCE MENU]

Quit DIP-SW Status

PT Setting

I/O Check

Init. Memory

Memory Switch

Select “Memory Switch”.



MEMORY SW MENU (1/2)

Comm. Type	Host Link	Quit
Key Sound	OFF	Page
Buzzer Sound	OFF	↓
Bk light Off	None	WRT& EXIT
Tool Mode	NT20M	

Select “Page”.



MEMORY SW MENU (2/2)		Quit
Automatic Reset	No	Page ↑
Baud Rate	9600bps	WRT& EXIT

Each time the “Automatic Reset” touch switch is pressed, the setting option “Yes” alternates with “No”.

(The figure to the left shows the NT20S-ST121-EV3 screen.)

To set and quit the menu, press the [WRT&EXIT] touch switch. To quit without setting, press [Quit].

- “No”: If a communication error has occurred, corresponding error message is displayed and the operation stops.
- “Yes”: If a communication error has occurred, corresponding error message will not be displayed and the operation will be automatically reset.

3-6 Registering the Screen Data

The screen data is created by using the support tool and registered to the NT20S screen data memory. This section describes the procedure to register the screen data to the NT20S. For the screen data creation and the support tool operation, refer to the NT-series Support Tool Operation Manual (V028-E1-1).

Reference: The screen data transmission speed can be increased by setting “Hi speed” for “Communication Mode” on the Tool Settings screen of the support tool.

Unit of Screen Transmission – Transmission in File Units

The NT20S uses several screens which are switched on its display. The screen data of one NT20S unit corresponds to the files created by using the support tool. Select a file which contains the screen data to be transmitted when selecting the screen data to be transmitted to the NT20S so that the required screen data can be transmitted to the NT20S.

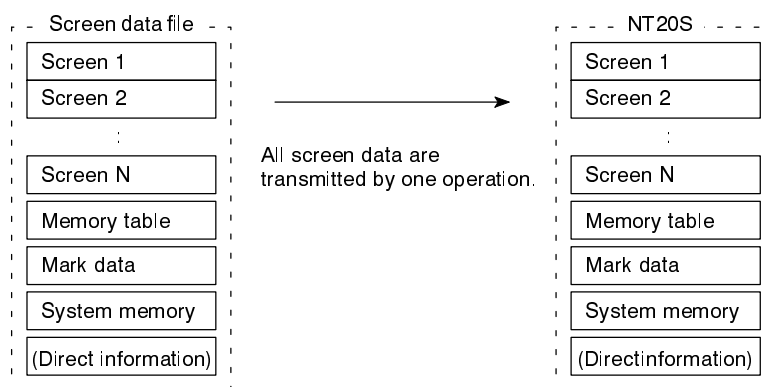

When the screen data is transmitted from the support tool to the NT20S, the screen data already existing in the NT20S will be erased.

If an error message and the System Menu are displayed immediately after the NT20S has been started, the screen data memory needs to be initialized.

Data Transmission in Screen Units

The NT20S allows the transmission of data for specified screens. By selecting the screen number of the screen to be transmitted using the support tool, it is possible to transmit the required screen only to the NT20S (it is also possible to transmit multiple screens in a batch).

When changes have also been made to the memory tables or direct connection information, transmit the changed data to the NT20S too, for example by using transmission in screen units.

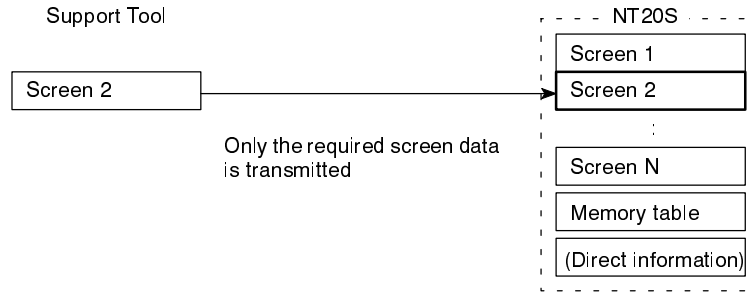

Caution: When screen data transmission is in screen units, if there is data other than screen data, for example memory table or direct access changes, transmit this data also.

Reference: When screen data is transmitted to an NT20S, it is written into a free area of the memory without overwriting the existing data. This means that if data transmission in screen units is performed frequently, there will come a time when there is no more free area in the memory and further transmission is impossible. If this happens, transmit the data in file units to reorganize the contents of the NT20S memory.

Transmitting the Screen Data from the Support Tool

To transmit the screen data from the support tool to the NT20S, connect the NT20S to the computer on which the support tool is being used, and follow the procedure below.

Reference: When the screen data transmission is attempted, the screen data memory in the NT20S is automatically initialized before new screen data is transmitted. It is not necessary to initialize the screen data memory by using the menu before the screen data transmission.

The NT20S-ST121-EV3/ST128 uses the same connector for screen data transmission and connection to the Host. If this connector is currently connected to the host, disconnect the cable from it and connect it to the support tool (personal computer) before attempting screen data transmission.

- Operation**
1. Connect the NT20S to a PC in which the support tool has been installed and turn on the power to the NT20S.
 2. Turn ON the computer and start up the support tool.
 3. Enter the "Transmit Mode" by operating the menu of the NT20S as mentioned below.

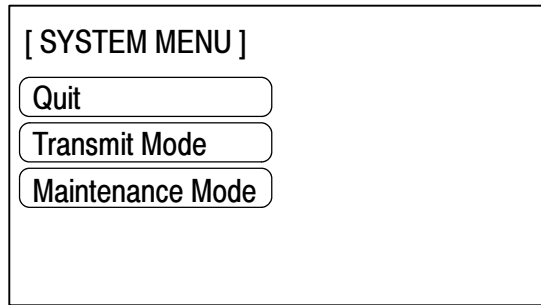

Select "Transmit Mode".

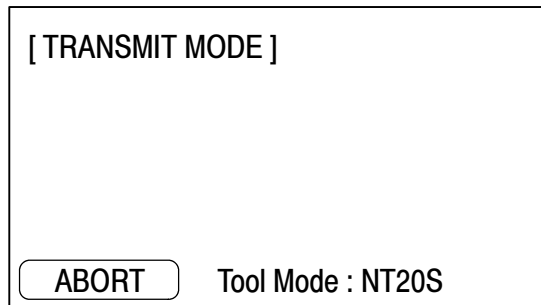

The transmit mode is established. When using an NT20S-ST121-EV3/ST122-V1, the "support tool mode" setting will be displayed on the bottom line of the screen, as shown in the figure to the left (nothing is displayed here on the screen of the NT20S-ST128).

4. Select a screen data to be transmitted to the NT20S in the File Selection screen of the support tool, and press the Send key.
5. The NT20S will display the following screen when the screen data is being transmitted.

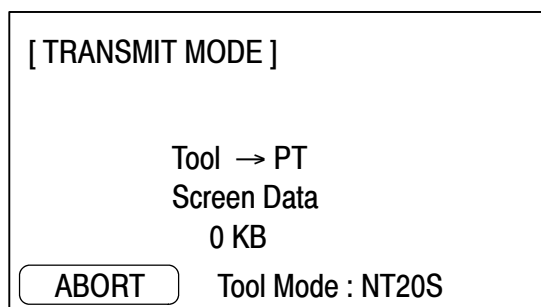

- When the screen data transmission is completed, the support tool will display the following screen.

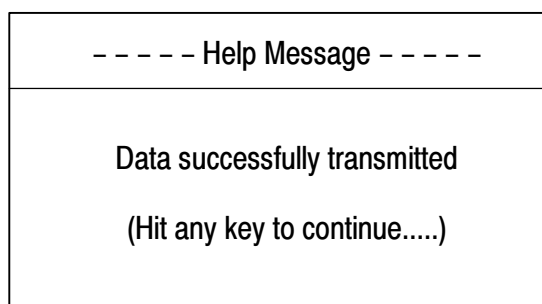

- Press any key on the support tool to return to the File Selection screen.
- Pressing the ABORT touch switch in the Transmit Mode screen of the NT20S will exit the Transmit Mode and enter the RUN Mode.

Note: Press the “Abort” touch switch on the NT20S when the screen data transmission is completed. Unless this touch switch is pressed, the screen data will not be correctly registered. If the “Abort” touch switch is pressed during transmission, the screen data will not be correctly registered.

If screen data cannot be transmitted from the support tool, confirm normal communication between the NT20S and the support tool (Personal computer). Use the tool communication check function in the Maintenance Mode of the NT20S to check communication with the support tool. Refer to “Checking the Communications with the Support Tool” on page 100.

Precautions to be Observed During the Screen Data Transmission

When any of the following or a system error occurs during the screen data transmission, the transmitted screen data will not be registered correctly to the NT20S. If an error message is displayed in the System Menu and the RUN Mode cannot be selected, the screen data memory needs to be initialized.

- The power to the NT20S is interrupted or reset.
- The power to the computer on which the support tool is running is interrupted or reset.
- The cable connecting the NT20S to the computer on which the support tool is running is interrupted or reset.
- The “Abort” touch switch on the NT20S screen is pressed to end the transmission.
- The ESC key on the support tool is pressed to end the transmission.

When the power to the NT20S is turned ON or reset, the screen data is checked. However, if any of the above occurs during the screen data transmission, the screen may disappear and other unexpected problems may occur.

In the case of such problems, set DIP SW2-1 to ON to initialize the memory.

For the memory initialization by using the DIP switch, refer to the “Initialization by using the DIP switch” (page 74).

3-7 Starting the Operation

After completing the screen data transmission and setting the communication conditions, connect the NT20S to the Host and start operation.

Switching to the RUN mode Press the Quit touch switch in the System Menu. The start-up screen in the RUN mode will be displayed.

If the NT20S has failed to start correctly; e.g., the start-up screen is not displayed, an error message is displayed, or the screen is not displayed at all, refer to Section 7-2 “Responding to Displayed Error Messages” (page 237) and take appropriate action.

Reference: When using an NT20S-ST121-EV3/ST122-V1, the screen displayed on startup is the one specified in the screen switch setting of the PT status control area. When using an NT20S-ST128, the startup screen is specified with the support tool when creating the screen data. If no startup screen is specified, screen No.1 becomes the startup screen. If no screen data is registered for the startup screen, the error message “Screen not registered” is displayed. For details on screen numbers, see 4-3 “Screen Display” (page 122).

Confirming the Communications between the NT20S and the PC/Host

When using the NT20S-ST128, use the RS-232C communication check function in the Maintenance Mode to confirm normal communication between the NT20S and the host. Refer to “Checking the Communications with the Host” on page 102. When using the NT20-ST121-EV3/ST122-V1, run the Host program and check that the following operations are executed normally.

- Confirm that the NT20S screens switch according to the Host program execution.

If the screens do not switch correctly, check the connection between the NT20S and the Host and also check the settings.

Refer to Section 2 Hardware Settings and Connections.

- Confirm that the information selected by the NT20S touch switches has been correctly sent to the PC by displaying the information of bits and words by using a peripheral tool (LSS etc.). If the information sent from the NT20S has not been correctly received by the PC, check the screen data settings (specifically the switch settings).

For the details of the screen data creation, refer to the NT-series Support Tool Operation Manual (V028-E1-□).

3-8 Various System Settings

The NT20S can set a variety of functions to the memory switches which are convenient during the operation. This section describes the memory switch settings related to the operation environment.

3-8-1 Setting the Key Press Sound

Whether or not the key press sound is given when the NT20S touch switch is pressed can be set with the memory switch.

The factory setting has been set to give the key press sound when the touch key is pressed.

Set the key press sound by the menu operation from the System Menu as mentioned below.

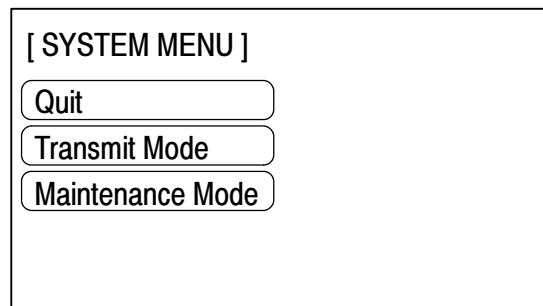

Select "Maintenance Mode".

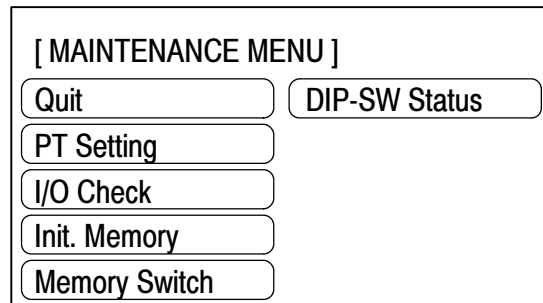

Select "Memory Switch".

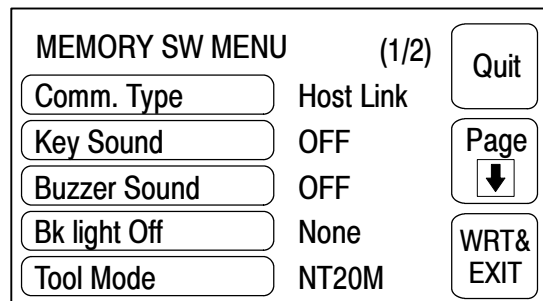

Each time the "Key Sound" touch switch is pressed, the setting option "ON" alternates with "OFF".
(The figure to the left shows the NT20S-ST121-EV3 screen.)

To set and quit the menu, press the [WRT & EXIT] touch switch. To quit without setting, press [Quit].

- ON: The key press sound will be given for 0.2 second when a touch switch is pressed.
- OFF: The key press sound will not be given when a touch key is pressed.

3-8-2 Using the Buzzer

The NT20S can set a buzzer to indicate the occurrence of an emergency or an NT20S error.

Setting the Buzzer

Except when the buzzer has been set so as not to sound at all, the buzzer will sound when an error occurs. To set the buzzer to sound in other cases, the following two procedures can be used.

- Controlled by the Host

It is possible to control the NT20S from the Host to sound the buzzer during the operation.

Refer to Section 5-4 NT20S Status Control (page 191).

- Set the buzzer as a screen data attribute by using the support tool.

When creating the screen data by using the support tool, set the buzzer as a screen attribute so that the buzzer will sound. When the screen in which this attribute has been set is displayed, the NT20S will give the buzzer sound.

If the control by the Host and the display of the screen in which the buzzer attribute has been set are executed simultaneously, the priority is given to the control by the Host. Refer to the NT-series Support Tool Operation Manual (V028-E1-□).

To Stop the Buzzer Sound

The buzzer sound can be stopped by the following operation.

- Control by the Host
- Switch the screen to a screen which does not have a buzzer attribute.
- Press the touch switch to which the buzzer stop attribute has been set.

Reference: If a buzzer stop attribute has been set to a touch switch created on the screen in which the buzzer attribute has been set, such touch switch can be used to stop the buzzer sound. For details on setting buzzer attributes for touch switches, see “Allocation of System Key Functions” (page 139).

Types of the Buzzer Sounds The following buzzer sounds can be set.

- Continuous sound: The buzzer continues to sound.
- Intermittent sound: The buzzer sounds intermittently at constant intervals.

Reference: If both the continuous buzzer and the intermittent buzzer are instructed by the Host, the continuous buzzer will sound.

Setting the Buzzer

Use the memory switches to set whether or not the buzzer sounds when the buzzer sound has been instructed by the Host or with a screen attribute or when an error has occurred.

The factory setting is “ON”, which means that the buzzer will sound when a command is received from the host, when a screen for which the buzzer attribute is set is displayed, and when errors occur.

Set the buzzer sound by the menu operation from the System Menu as mentioned below.

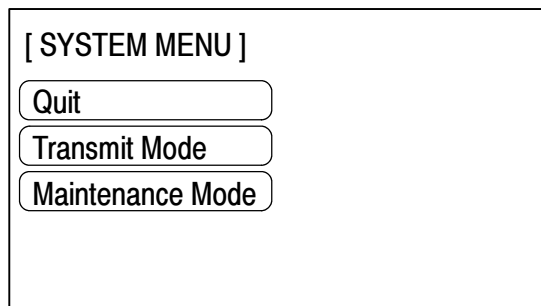

Select “Maintenance Mode”.

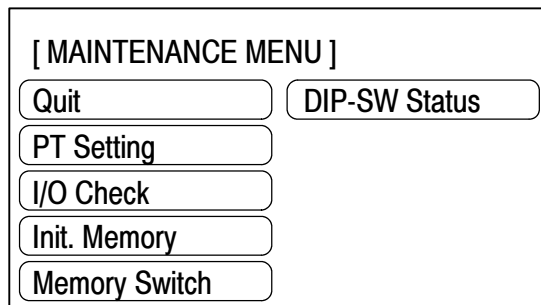

Select “Memory Switch”.

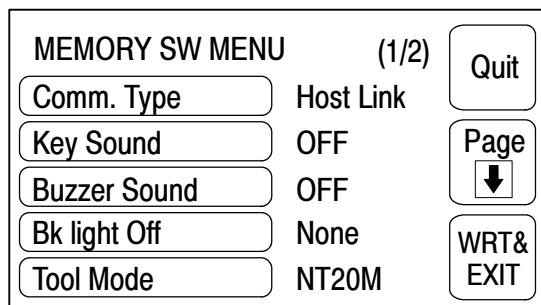

Repeatedly pressing the “Buzzer Sound” touch switch cycles through the setting options “ON”, “ERR ON”, and “OFF”, in that order.
(The figure to the left shows the NT20S-ST121-EV3 screen.)

To set and quit the menu, press the [WRT&EXIT] touch switch. To quit without setting, press [Quit].

- OFF: The buzzer will not sound at all during the operation.
- When “ON” is set, the buzzer will sound when a command is received from the host, when a screen for which the buzzer attribute is set is displayed, and when errors occur.
- When “ERR ON” has been set, the buzzer will sound only when an error has occurred.

Reference: The buzzer will sound when “Buzzer check” is selected in the Maintenance Mode regardless of the buzzer setting.

3-8-3 Backlight OFF Function

The NT20S has a function that turns off the backlight of the LCD panel to maximize its service life if no operation is performed for a certain period of time.

Turning on the Backlight

When a touch switch on the NT20S is pressed or a screen is switched or redisplayed by the PC when the backlight is off by the backlight off function, the backlight will turn on. Any changes of numeric values or characters displayed on the screen will not effect the backlight to turn on again.

Setting the Backlight OFF Function

Use the memory switches to set whether or not the backlight off function is used and the length of time to turn off the backlight.

The factory setting has been made so as to turn off the backlight if no operation has been performed for 10 minutes.

Set the backlight off function by the menu operation from the System Menu as mentioned below.

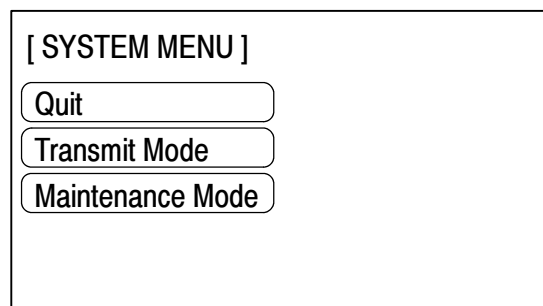

Select “Maintenance Mode”.

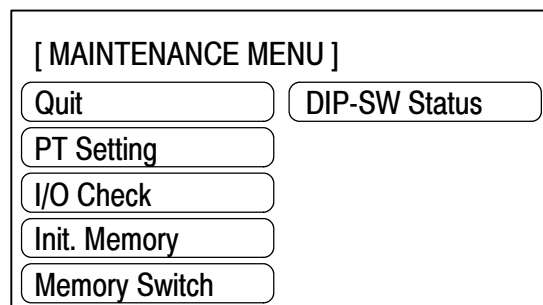

Select “Memory Switch”.



MEMORY SW MENU (1/2)		Quit
Comm. Type	Host Link	Page
Key Sound	OFF	↓
Buzzer Sound	OFF	WRT&EXIT
Bk light Off	None	
Tool Mode	NT20M	

Repeatedly pressing the “BK light Off” touch switch cycles through the setting options “10 min”, 1 hour, and None, in that order.
(The figure to the left shows the NT20S-ST121-V2 screen.)

To set and quit the menu, press the [WRT&EXIT] touch switch. To quit without setting, press [Quit].

- None: The backlight off function is not used. As long as no operation is performed, the same screen remains to be displayed.
- 10 minutes: The backlight will be turned off when no operation has been performed for 10 minutes.
- 1 hour: The backlight will be turned off when no operation has been performed for 1 hour.

**Caution:**

Do not press touch switches carelessly while the backlight is off or while nothing is displayed on the screen.

Otherwise the system may operate unpredictably.

Only press touch switches after confirming system safety.

Correct Use:

Continuous display of the same pattern for an extended time (as a guide, about 1 hour) will lead to the formation of an afterimage.

In order to prevent this, either use the screen saver function or periodically switch screens.

3-8-4 Support Tool Mode Setting (NT20S-ST121-EV3/ST122-V1 Only)

By setting “Tool Mode” to “NT20M”, the NT20M-ST121-EV3/ST122-V1 can be used in the same way as the conventional NT20M, and it becomes possible to use the NT20M/NT2000M/NT600M support tool (Ver.4.□).

However, the following restrictions apply when “NT20M” is set:

- Ver.5 of the direct connection function cannot be used.
- The PT type setting must be “NT20M”.
- High-speed data transfer with the support tool is not possible.
- It is not possible to transfer the direct information alone.
- When screen data transmission is in screen units, simultaneous transmission of multiple screens is not possible. An attempt to transmit multiple screens may destroy the screen data.
- When screen data transmission is in screen units, transmission with verification set is not possible.
- The image data memory must be initialized before starting transfer in file units.
- Screen data for RS-232C communication cannot be used.

Set the support tool mode by the menu operation from the system menu shown below.

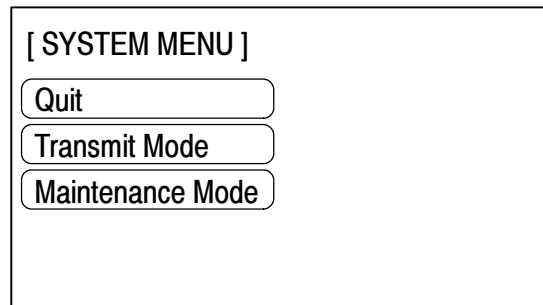

Select "Maintenance Mode".

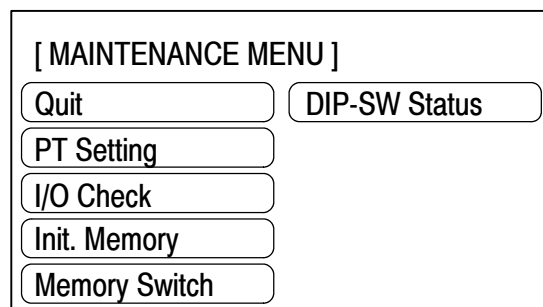

Select "Memory Switch".

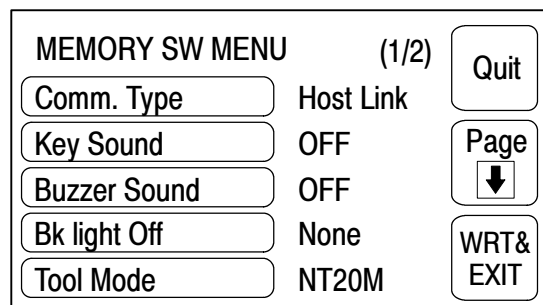

Each time the "Tool Mode" touch switch is pressed, the setting option alternates between "NT20S" and "NT20M". (The figure to the left shows the NT20S-ST121-EV3 screen.)

To quit after setting the selected item, press the WRT & EXIT touch switch. To quit without setting, press the Quit touch switch. The NT20S will enter the RUN mode.

- When "NT20M" is set, the NT20M compatible mode is established and the terminal can be used as an NT20M.
- When "NT20S" is set, the terminal can be used as an NT20S.

3-8-5 Lamp Bit Control (NT20S-ST128)

When using the NT20S-ST128 (using the RS-232C interface for communication with the host), you can select whether lamp statuses are controlled by bit designation or not.

The factory setting for this function is Enable (lamps numbered 0 to 31 controlled by bits).

Set the lamp bit control function by the menu operation from the System Menu as mentioned below.

[SYSTEM MENU]

Quit

Transmit Mode

Maintenance Mode

Select "Maintenance Mode".



[MAINTENANCE MENU]

Quit DIP-SW Status

PT Setting

I/O Check

Init. Memory

Memory Switch

Select "Memory Switch".



Key Press Sound	ON	Quit Page ↓ WRT& EXIT
Buzzer Sound	ON	
Bk light Off	10min	
Automatic Reset	Yes	

Select "Page down".



Data Bits	8bits	Quit
Stop Bits	1bit	Page
Parity Check	Even	↑
Flow Control	RS/CS	WRT&EXIT
Baud Rate	19200bps	
LMP Bit Control	Enable	

Each time the “LMP Bit Control” touch switch is pressed, the setting option “Enable” alternates with “Disable”.

To set and quit the menu, press the [WRT&EXIT] touch switch. To quit without setting, press [Quit].

- When “Disable” is set, the control of lamp display statuses by bits is not possible. The lamps numbered 0 to 31 can be controlled only by specifying lamp numbers.
- When “Enable” is set, lamp control by bits is possible. This means that the lamps numbered 0 to 31 can be controlled by specifying either lamp numbers or bits. However, it is not possible to make “lit”/“flashing” status selections by specifying lamp numbers: the selection made when the screen data was created remains effective.

3-9 System Maintenance

The NT20S has the self maintenance functions such as I/O check and setting status check.

3-9-1 I/O Check

The I/O operations for the following items of the NT20S are checked by the I/O check function.

- Touch Switch
- Communications with the support tool
- Communications with the Host (NT20S-ST128 RS-232C only)
- LCD
- LED Check
- The Screen Data Memory
- Buzzer

Checking the Touch Switches

Execute a touch switch check by the menu operation from the System Menu as mentioned below.

[SYSTEM MENU]	
Quit	
Transmit Mode	
Maintenance Mode	

Select "Maintenance Mode".



[MAINTENANCE MENU]	
Quit	DIP-SW Status
PT Setting	
I/O Check	
Init. Memory	
Memory Switch	

Select "I/O Check".



[I/O CHECK MENU]	
Quit	LCD Display
LED Check	Comm. Check
Buzzer	
Touch Switch	
Data Memory	

Select "Touch Switch".

A panel of 6-row x 12-column touch switches, each switch sized 1 x 1 cm, will be displayed.

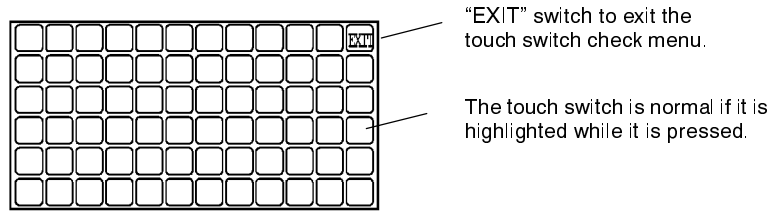

- Press a touch switch on the screen. If the touch switch is highlighted while it is pressed, the touch switch is normally functioning.
- When the check is finished, press the EXIT touch switch. The I/O check menu will be redisplayed.

Reference: If memory switch setting for the key press sound has been made for ON, the key press sound will be made when a touch switch is pressed. The statuses of touch switches pressed during an I/O check are not notified to the host.

Checking the Communications with the Support Tool

Execute a NT20S-to-support tool communication check by the menu operation from the System Menu as mentioned below.

The NT20S-ST121-EV3/ST128 uses the same connector for connection to the support tool and connection to the Host. If this connector is currently connected to the host, disconnect the cable from it and connect it to the support tool (personal computer) before attempting screen data transmission.

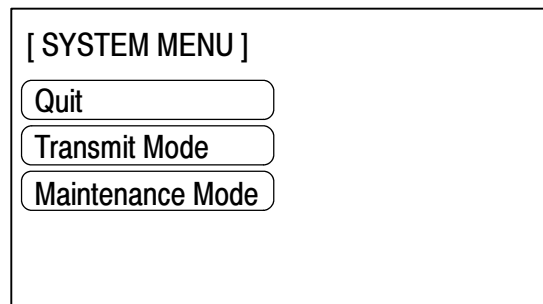

Select "Maintenance Mode".

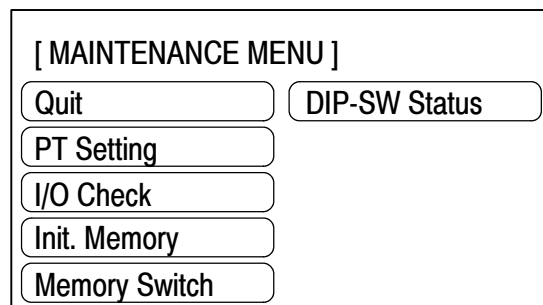

Select "I/O Check".

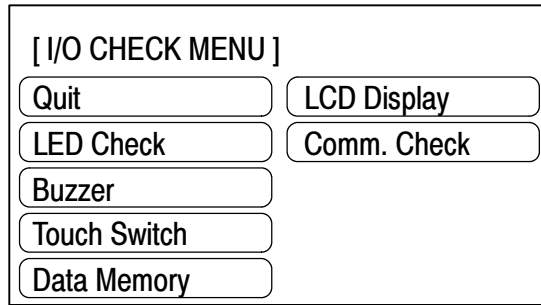

Select "Comm. Check".

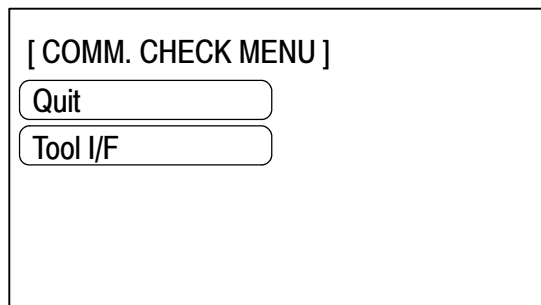

Select "Tool I/F".

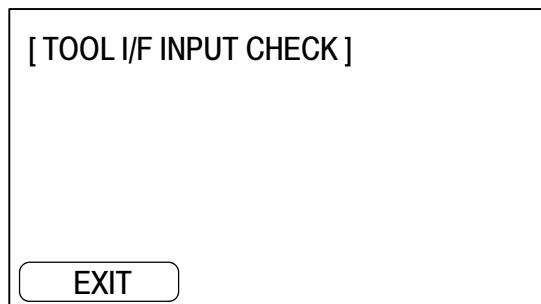

The data received from the connected support tool are displayed in hexadecimal numbers.

When the check is finished, press the Exit touch switch. The NT20S will enter the I/O CHECK MENU.

Checking the Communications with the Host (NT20S-ST128)

Execute a NT20S-to-Host communication check by the menu operation from the System Menu as mentioned below.

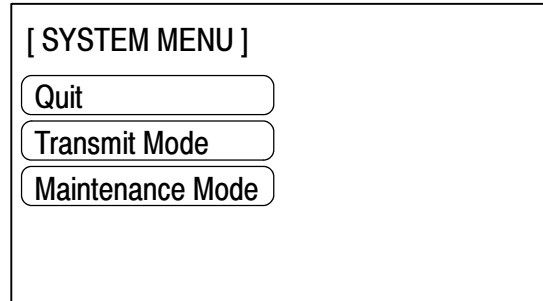

Select "Maintenance Mode".

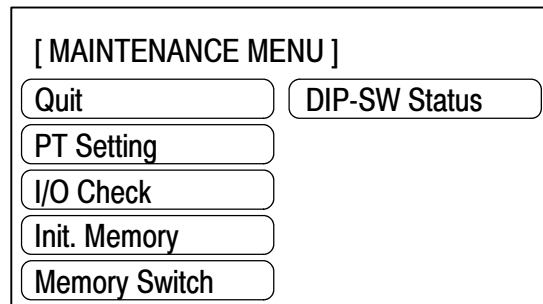

Select "I/O Check".

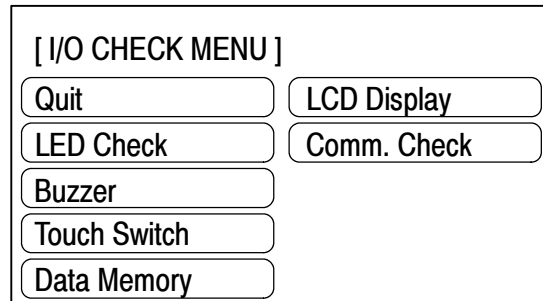

Select "Comm. Check".

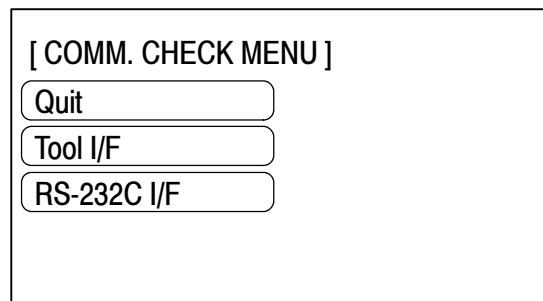

Select "RS-232C I/F".



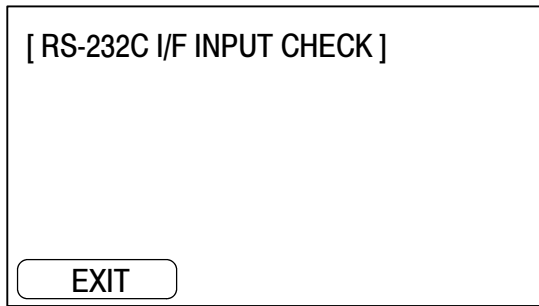

The data received from the connected Host are displayed in hexadecimal numbers.

When the check is finished, press the EXIT touch switch. The NT20S will enter the RUN mode.

Checking the LCD

Check the NT20S LCD by using the menu operation from the System Menu as mentioned below.

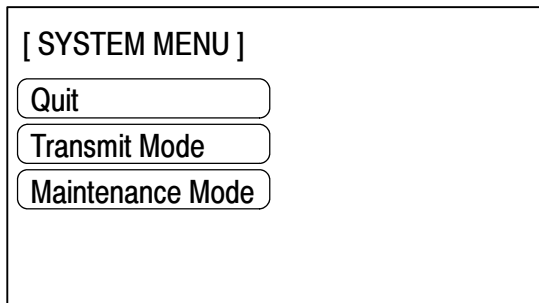

Select "Maintenance Mode".

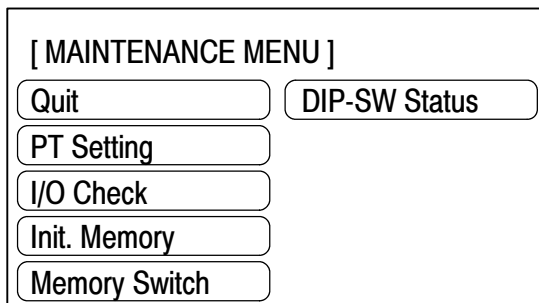

Select "I/O Check".

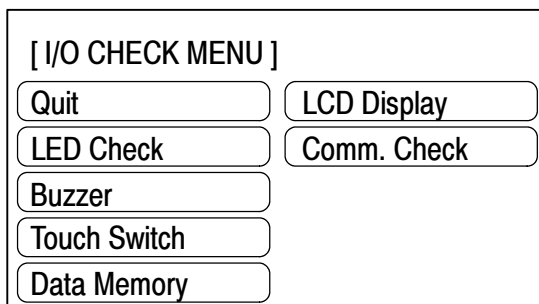

Select "LCD Display".

- The LCD displays dots (segments of the screen) line by line beginning with the top left corner. If all the dots are displayed normally, the NT20S will enter the I/O CHECK MENU after all the dots have been turned off.
- To cancel the LCD indication check, press any touch switch (anywhere) on the screen. The I/O Check Menu will be redisplayed.

Checking the Buzzer

Check the NT20S buzzer by using the menu operation from the System Menu as mentioned below.

[SYSTEM MENU]	
Quit	
Transmit Mode	
Maintenance Mode	

Select "Maintenance Mode".



[MAINTENANCE MENU]	
Quit	DIP-SW Status
PT Setting	
I/O Check	
Init. Memory	
Memory Switch	

Select "I/O Check".



[I/O CHECK MENU]	
Quit	LCD Display
LED Check	Comm. Check
Buzzer	
Touch Switch	
Data Memory	

Select "Buzzer".

- If the buzzer function is normal, the continuous buzzer sound will be made.
- To stop the buzzer, press "EXIT" touch switch in the buzzer check screen. The NT20S will enter the I/O CHECK MENU.

Reference: Though memory switch setting for the buzzer has been made for OFF, the buzzer will sound when the buzzer check is executed.

Checking the LED

Check the LED by using the menu operation from the System Menu as mentioned below.

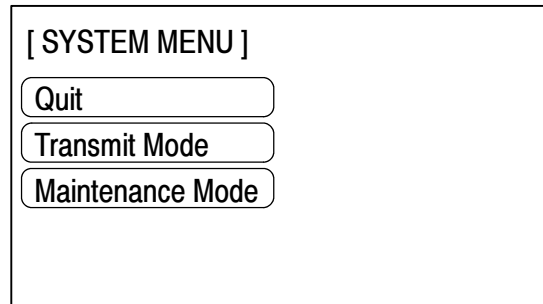

Select "Maintenance Mode".

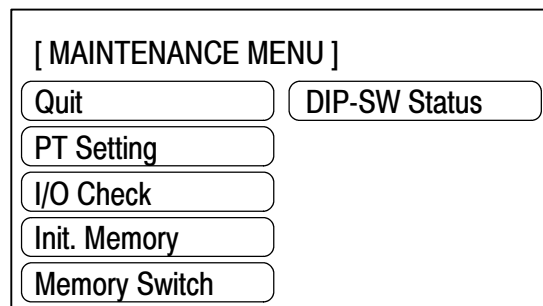

Select "I/O Check".

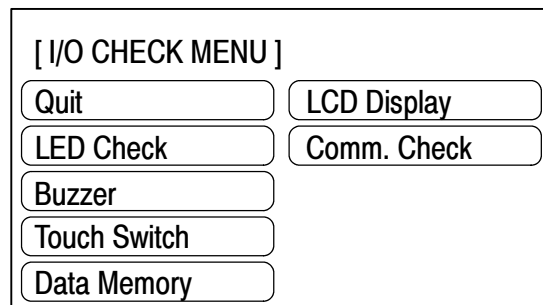

Select "LED Check".

The "RUN" LED on the front face of the NT20S will flash. The "POWER" LED remains lit.

- To quit the LED check, press the "EXIT" touch switch. The NT20S will enter the I/O CHECK MENU.

Checking the Screen Memory

Check the screen memory by using the menu operation from the System Menu as mentioned below.

Reference: When the screen data memory is checked, the memory is initialized and all the screen data is lost. Check that the screen data has been backed up using the support tool before executing a screen data memory check.

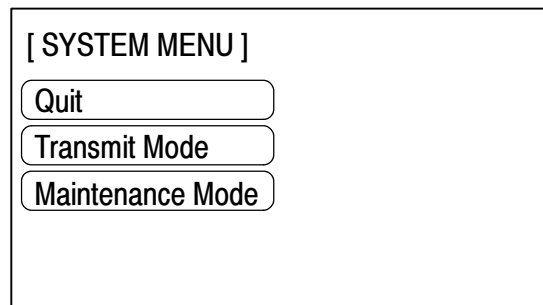

Select "Maintenance Mode".

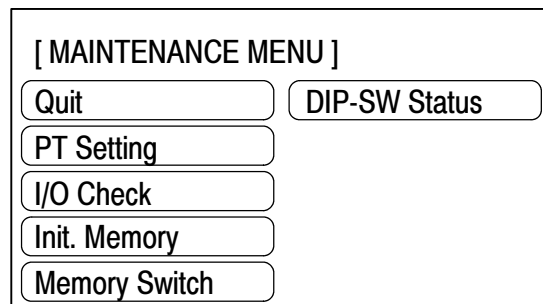

Select "I/O Check".

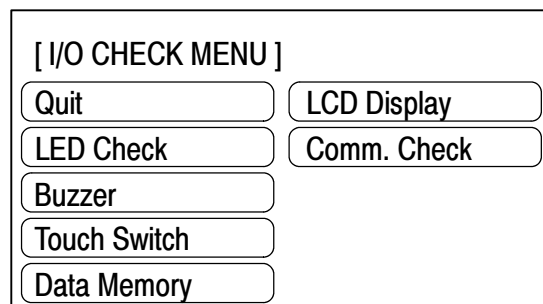

Select "Data Memory".

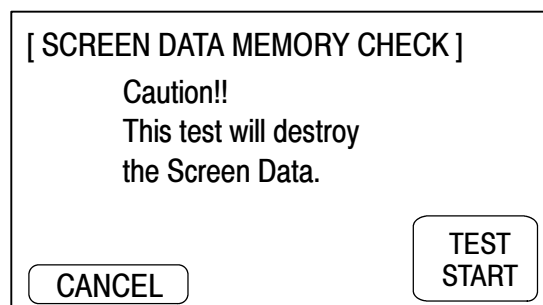

Press "TEST START".
Pressing "Cancel" will cancel
the memory check.

The screen memory check will start.

While the screen memory is checked, the “Memory checking...” message will be displayed.

- If the memory check has been normally completed, the “Memory is OK” message will be displayed.
- To quit the memory check, press the “Cancel” touch switch. The NT20S will enter the I/O CHECK MENU.
- If the “Memory error!!” message is displayed, the screen data memory may have been used up to its service life or there may be a hardware fault. In that case, initialize the screen data memory and check the memory again. If the same error message is displayed again, consult the OMRON Service Center.

3-9-2 Checking the PT Setting

Display the NT20S settings by using the menu operation from the System Menu as mentioned below.

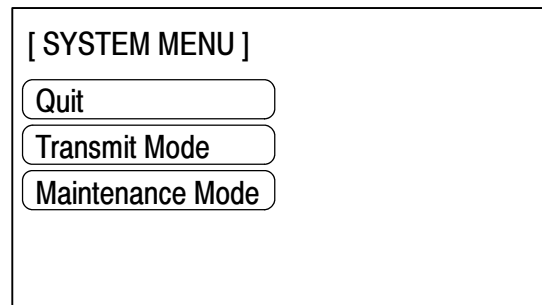

Select “Maintenance Mode”.

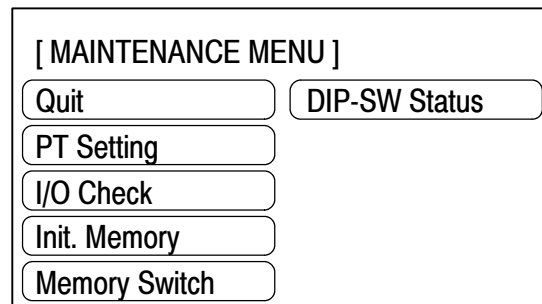

Select “PT Setting”.



[NT20S-ST121-EV3]

(Host link)

[PT SETTING]	
PT Control Area	DM0000
PT Notify Area	DM0010
Comm. Type	Host Link
Baud Rate	9600bps
EXIT	

(NT Link (1:1))

[PT SETTING]	
PT Control Area	DM0000
PT Notify Area	DM0010
Comm. Type	NT Link
EXIT	

(NT Link (1:N))

[PT SETTING]	
PT Control Area	DM0000
PT Notify Area	DM0010
Comm. Type	NT Link 1:N
Unit No.	7
EXIT	

[NT20S-ST122-V1 (C200H direct communication)]

[PT SETTING]	
PT Control Area	DM0100
PT Notify Area	DM0200
Comm. Type	C200H
Unit No.	0
EXIT	

[NT20S-ST128 (RS-232C)]

[PT SETTING]	
Data Bits	8bits
Stop Bits	1bit
Parity Check	Even
Flow Control	RS/CS
Baud Rate	19200bps
EXIT	

* If no unit number is set at the PC, "0" will be displayed.

- The current PT settings will be displayed.
- Pressing the "EXIT" touch switch will exit the PT settings display, and the NT20S will return to the RUN Mode.

3-9-3 Checking the NT20S DIP Switch Settings

Display the NT20S DIP switch settings by using the menu operation from the System Menu as mentioned below.

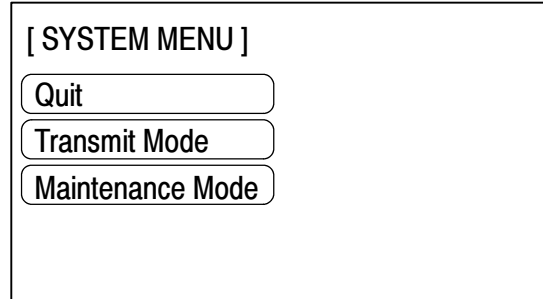

Select "Maintenance Mode".

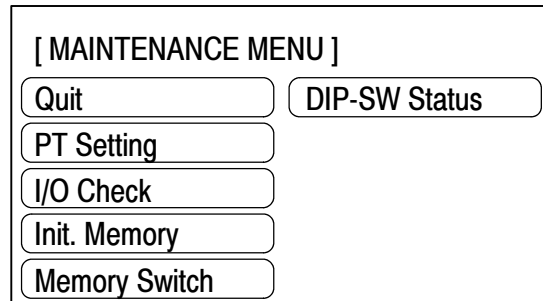

Select "DIP-SW Status".

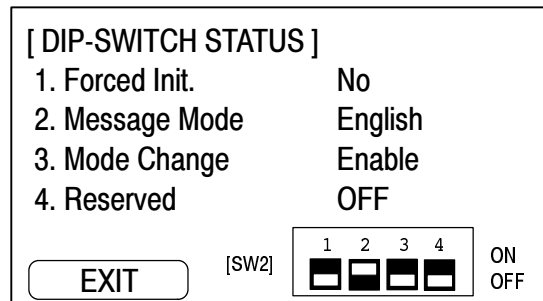

- The NT20S DIP switch statuses are displayed.
- Pressing the EXIT touch switch clears the DIP switch status display from the screen and causes the NT20S to enter the RUN mode.

Note: If the DIP switch settings have been changed when the NT20S is powered, reset the power to the NT20S. The changes with the DIP switches become effective only after the power supply is reset.

SECTION 4

NT20S Functions and Operation

This section describes the functions of the NT20S.

4-1	Creating and Transmitting Screen Data	112
4-1-1	Setting the support tool for use with the NT20S	112
4-1-2	Creating Screen Data	113
4-2	Outline of Functions	118
4-2-1	NT20S Screen	118
4-2-2	Characters and Figures Which can be Displayed	119
4-2-3	Communications with the Host	120
4-3	Screen Display	122
4-3-1	Classification of Screens	122
4-3-2	Screen Attributes	125
4-4	Memory Tables	126
4-4-1	Character-String Memory Table	126
4-4-2	Numeral Memory Table	127
4-5	Bar Graphs	129
4-5-1	Bar Graph Functions	129
4-6	Lamps	133
4-6-1	Lamp Functions	133
4-7	Touch Switches	136
4-7-1	Functions of Touch Switches	137
4-7-2	Screen Switching Function	138
4-7-3	System Key Functions	139
4-8	Numeral Setting	140
4-8-1	The Numeral Setting Function	140
4-8-2	Types of Numeral Setting	142
4-8-3	Creating Numeric Keys	143
4-8-4	Using Numeric Keys	145
4-8-5	Using The Thumbwheel Type of Numeral Setting (Ver.5 Direct Connection Only)	147
4-8-6	Settings for Numeral Settings	148

4-1 Creating and Transmitting Screen Data

This section describes briefly the support tool settings required for creating screen data and the screen data creation procedure.

Reference: For the details of the support tool and screen data creation, refer to the “NT-series Support Tool Operation Manual” (V028-E1-□).

4-1-1 Setting the support tool for use with the NT20S

To create the screen data for the NT20S, make settings with the support tool for use with the NT20S.



Select “Tool Settings”.

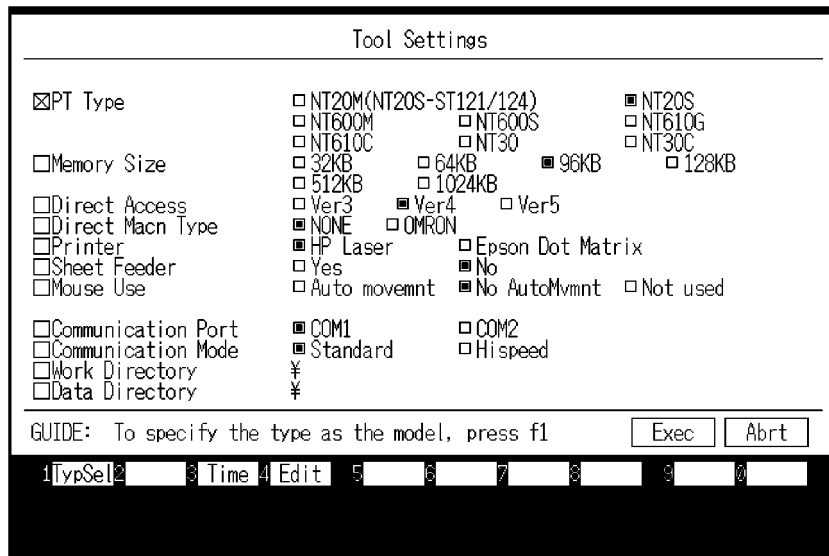

To create the NT20S screen data, make settings in the “Tool Settings” screen as follows.

NT20S-ST121-EV3 (Host link/NT link), NT20S-ST122-V1 (C200H direct communication)

PT Setting : 20S
Memory Size : 96 KB
Direct setting : Ver.4 or Ver.5
Direct Macn Type: OMRON

NT20S-ST128 (RS-232C)

PT Setting : NT20S
Memory Size : 96 KB
Direct setting : None
Direct Macn Type: OMRON

4-1-2 Creating Screen Data

Screen Data Creation Method

The screen data is created by using the support tool. The support tool registers the screen data used with one NT20S to one file.

Screen data can be created by one of the following three methods:

- creating a new file;
- editing an existing file;
- reading and editing selected screens from an existing file.

Screen Data Creation Procedure

The following gives the basic screen data creation procedure. Required settings and reference pages are given for each step of the procedure.

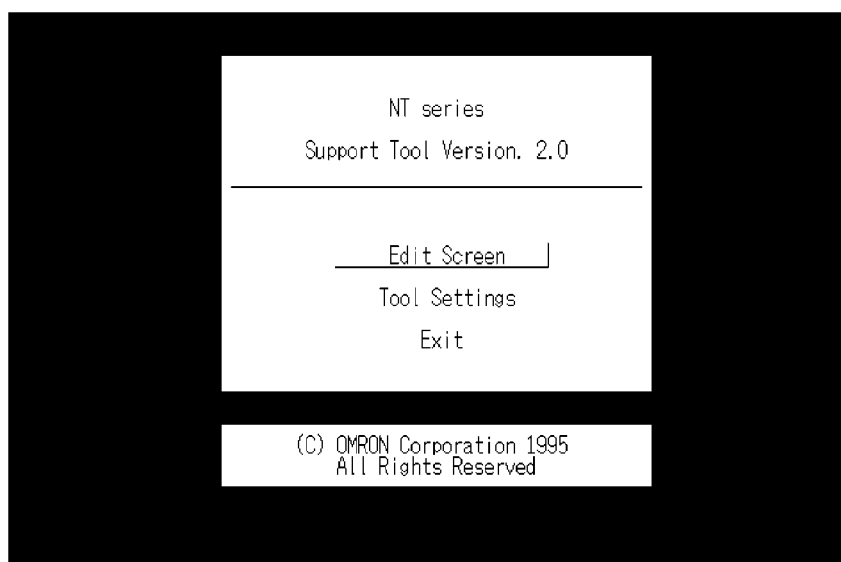

- ➔ Select "Tool Settings" in the Main Menu to display the "Tool Settings" screen. Settings of PT setting, memory size, and direct setting are made in this screen. Refer to "Setting the support tool for use with the NT20S" on the previous page.



Select "Tool Settings".

File List	NT2OS-V4	96KB
FileName	Title	1/ 10 PaDn PaUp
NEW_FILE	Creation of New File	
INPT_SCR	For Line Input	
PROC_B	Process control backup	
PROC_C	Production Qty Check	
SAMPLE		
INPT_SCR	For Line Input	
PROC_B	Process control backup	
PROC_C	Production Qty Check	
PROC_CTL	For process A	

File Selection	
Help Message	
<u>Esc</u> Exit to Main Menu	
NT2OS	Ver 4.0
Direct	None
Num. Mem. Tabs	128
Str. Mem. Tabs	32
DAC func.	0.00KB

1 Copy 2 Delete 3 Print 4 Tools 5 Hist. 6 Tmx. 7 Rcv. 8 In. Scr 9 Title 0 Next

➔ Select a file used for storing the screen data for the NT20S in the "File List" screen.

To create a new file, select "New File".

To edit an existing file, select a file to edit.

Select "New File" and press [Enter]. Enter filename on completion of creation.



Select "Screen Creation".

[NEW_FILE] Scr List			NT2OS-V4	96KB
No.	Status	Comment	PaDn	PaUp
1				
2				
3				
4				
5				
6				
7				
8				
9				
10				
11				
12				
13				
14				
15				
16				

Screen Selection	
Help Message	
<u>Tab</u>	Specified Page
<u>Space</u>	Mark/Unmark
<u>Home</u>	Unmark All
<u>Shift+Home</u>	Mark/Unmark All
<u>Esc</u>	Select File
Hist.	[]
0Byte	

1 Copy 2 Delete 3 Print 4Attrib 5 Read 6Commnt 7Attr 8Co/Ovl 9 Mark 0 Next

Select a screen number to edit in the selected file in the "Screen List" screen.

Note that when using the host link, NT link, or C200H direct communication, the PT status control area and PT status notify area must be set as described below before selecting the screen number.

To read the screen data from other file, press the [F5] (Read) function key.

Host link/NT link/C200H direct communication

- ➔ Press [F10] (Next) in the “Screen List” screen, then press [F2] (Direct) to display the Direct Conn. Setting screen. On this screen, specify the first words allocated to the following areas in the PC memory.
- PT status control area: Section 5-4 NT20S Status Control (page 191)
- PT status notify area: Section 5-5 Notification of the Operating Status to the PC (page 196)
- Numeral memory table: Numeral Memory Table (page 127)
- Character string memory table: Character-String Memory Table (page 126)

Common to All Communication Methods

Press [F4] (Attrib) in the “Screen List” screen to set the screen attributes in the Help Message. The following attributes can be set.

- Buzzer (None/Cont/Long/Shrt)
- Bit In (YES/NO)
- Keypad (Syst/User)
- Backlight (ON/OFF)
- ➔ Bit input attributes can be set when using the NT20S-ST128 (RS-232C).



Select a screen number and press [Enter].

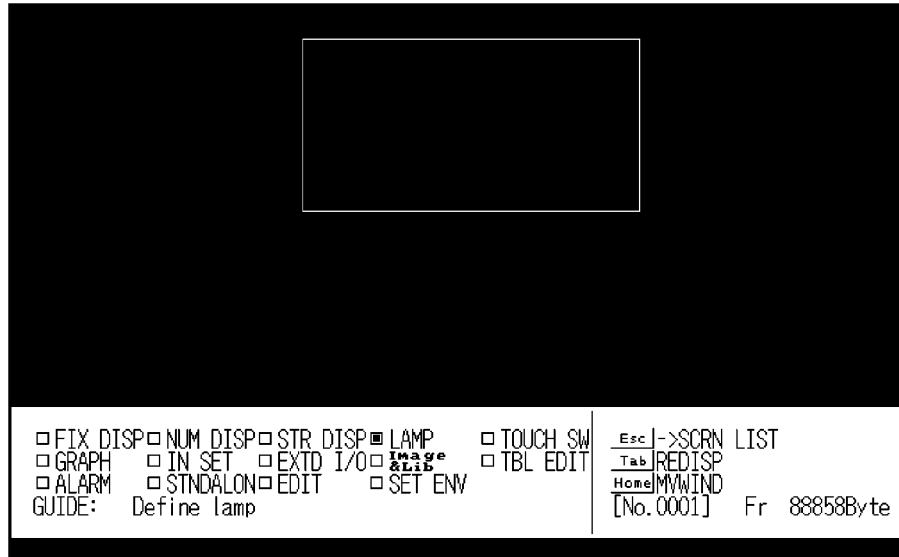

Create screen data in the Edit screen. Data of one screen can be created by registering (laying out) the following display elements and attributes on the screen.

- Fix display:
Input character strings and figure.
..... “Characters and Figures Which can be Displayed” (page 119)
- Numeral display:
Set numbers in the numeral memory table.
..... “Numeral Memory Table” (page 127)

- Character string display:
Set the character string memory table number and display method.
..... “Character-String Memory Table” (page 126)
- Lamp:
Set the lamp number or allocated bit and display method.
..... Section 4-6 Lamps (page 133)
- Touch switch:
Set the touch switch number, screen switching number, allocated bits for control and notification, and display method.
..... Section 4-7 Touch Switches (page 136)
- Graph:
Set the numeral memory table number and display method.
..... Section 4-5 Bar Graphs (page 129)
- Input setting:
Set numbers in the numeral memory table.
..... Section 4-8 Numeral Setting (page 140)



[Edit screen quit]

Return to the “Screen List”.

To successively create or modify another screen, select the screen number.

No.	Status	Comment	Padn	PaUp
1	B FG!	Display1		
2	B D-G!	Display2		
3				
4				
5				
6				
7				
8				
9				
10				
11				
12				
13				
14				
15				
16				

Screen Selection

Help Message

Tab | Specified Page

Space | Mark/Unmark

Home | Unmark All

Shift+Home | Mark/Unmark All

Esc | Select File

Hist. []

B: Beep

F: Keys G: Ext

102Byte

1 Copy 2 Delete 3 Print 4 Attrib 5 Read 6 Comment 7 Image 8 Co/Ovl 9 Mark 0 Next



[To the File Selection]

Enter filename to newly created screen data.
Return to the "File List".

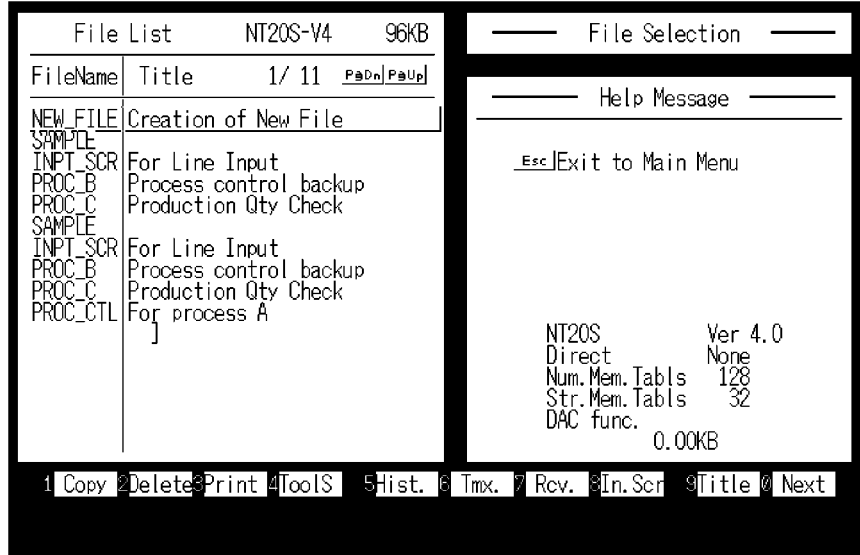

Pressing the [F8] (Start-up screen) key allows setting of the screen number to be displayed when the NT20S is booted. (Only effective when using RS-232C)

Transmitting Screen Data to the NT20S

Transmit the screen data created by using the support tool to the NT20S screen data memory.

Pressing the [F6] (Tmx.) key on the "File List" screen will cause the created screen data to be transmitted to the NT20S in file units. Pressing [F10] (Next) and then [F6] (Tmx.) on the "File List" screen will cause the screen data to be transmitted in screen units. Before attempting data transmission, connect the NT20S and support tool and set the NT20S to the transmit mode.

For the connection procedure to the support tool, refer to Section 2-3 Connecting to the Support Tool (page 31). For the transmission of the screen data, refer to Section 3-6 Registering the Screen Data (page 86).

Note: When transmitting data in screen units, if changes have been made to memory tables or direct information in addition to the screens, transmit this changed data also.

4-2 Outline of Functions

4-2-1 NT20S Screen

This section gives the outline of the screen which is the basis of all NT20S functions.

For specific operation procedure such as screen switching, refer to “Switching the Screen Display” (page 157).

Composition of the Screen

The NT20S screen is composed of horizontal 256 dots x vertical 128 dots. Each dot is set by the combination of the X (horizontal) and Y (vertical) coordinates. The origin of coordinates (0, 0) is set at the top left corner of the screen.

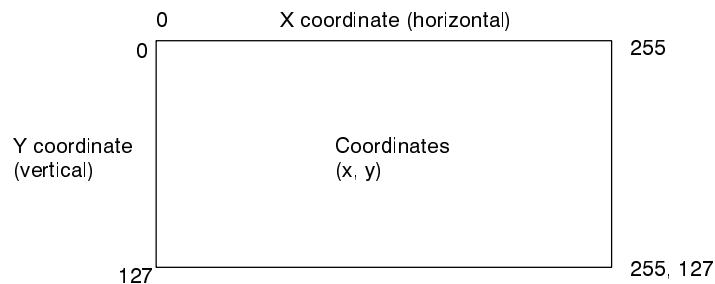

Screen Management

The screens displayed on the NT20S are managed by the screen numbers.

When using the NT20S, up to 495 screens can be created and screen numbers in the ranges 1 to 250 and 256 to 500 can be used (numbers 251 to 255 are reserved for system use).

The display screens can be switched or the start-up screen can be set by designating the screen number from the Host.

Special Screen Number

Screen number “0” is reserved for the system as the no-display screen. Select this to display nothing on the NT20S screen.

4-2-2 Characters and Figures Which can be Displayed

The NT20S screen can display characters, figures, and other various elements.

This section describes the types and attributes of the characters and figures which can be displayed and do not need to be changed at all.

For the settings, display, and use of the characters, numeric values, and graphs which change according to the system operation status and other conditions, refer to Section 4-4 Memory Table (page 126).

The power of expression of the screen can be increased by giving various attributes such as the enlarged or reverse display to the characters and figures.

The character and figure attributes can be set in the edit screen when creating the screen data by using the support tool.

When using the NT20S-ST128 (RS-232C), character strings can also be displayed in accordance with commands from the host, independently of the currently displayed screen (this is the "terminal function").

Types and Attributes of Characters and Figures

The following types of characters can be input by using the support tool and be displayed during operation.

Character Type	Dots (vertical x horizontal)	Character Set	Maximum Number of Characters Displayed in One Screen (without overwriting)
Half height characters	8 x 8	Alphanumerics and symbols	32 characters x 16 lines (512 characters)
Normal characters	16 x 8	Alphanumerics and symbols	32 characters x 8 lines (256 characters)
Marks	16 x 16	Create by using the support tool	

- Marks

A mark is a graphic pattern created by combining 16 x 16 dots by using the support tool. Marks can be handled the same as the wide size characters. Up to 64 patterns can be defined within the total screen data using character code FF20 to FF5F.

- Enlarged display of the characters and marks

The characters and marks can be enlarged to the following scales.

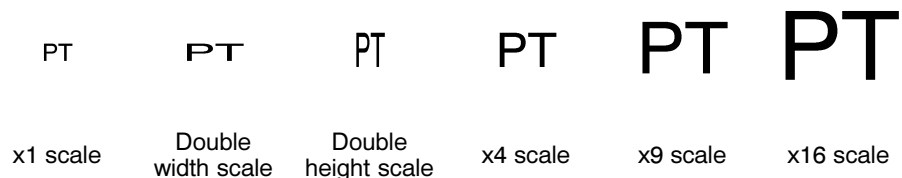

Reference: Smoothing

The characters and marks enlarged to the x4 scale or larger are displayed with the outline automatically smoothed. This function is called "smoothing".

- Reverse and flashing display

Reverse display:

The display brightness of the character and the background is reversed comparing with the normal display.

Flashing display:

Characters are displayed as they flash. The normal display alternates with no-display.

Reverse and flashing display:

The reverse display alternates with the normal display.

Types and Attributes of the Figures

The following types of figures can be input by using the support tool and be displayed during operation. Continuous straight lines including up to 256 vertexes can be drawn (up to 255 straight lines can be connected).

Continuous straight lines

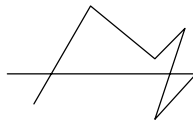

Circle



4-2-3 Communications with the Host

Communication using the host link/NT link/C200H direct communication

The NT20S-ST121-EV3/ST122-V1 can communicate with the PC through the host link/NT link/C200H direct communication. Bits and words are allocated to areas of the PC memory (selectable without restriction) and the NT20S can write data to them or read from them directly. This makes the following functions possible:

- Control/Notification of display elements
- Control/Notification of the NT20S status
- Screen switching
- Ascertaining the number of the screen currently displayed
- Memory table operations

For details on actual operations, refer to Section 5 “How to Use the Host Link/NT Link”

Communication through RS-232C

The NT20S-ST128 can communicate with the host through the RS-232C interface. In other words, it can receive and send commands through the RS-232C interface, which allows various types of host to utilize the functions of the NT20S:

- Control/Notification of display elements
- Control/Notification of the NT20S status
- Memory table operations
- Screen operation
- Display/Deletion of characters/graphics

For details on actual operations, refer to Section 6 “Using the RS-232C”

Controllable NT20S functions

The following NT20S statuses can be controlled:

- Screen switching: Screen is displayed or cleared.
- Continuous/intermittent buzzer: Buzzer operation is started or stopped.
- Back light mode: Back light is lit or made to flash.

For details on how these NT20S functions are actually controlled, refer to Section 5-4 “NT20S Status Control” on page 191, “Screen Display Control” on page 215, and “Buzzer Control” on page 215.

Ascertainable operating statuses of the NT20S

The following operating statuses of the NT20S can be ascertained:

- NT20S operating/stopped status: Whether the NT20S is active or inactive
- Screen number: Number of the screen currently displayed
- Numeral setting input: Whether or not numerical values have been input by numeral setting

For details on how these NT20S operating statuses are actually detected, refer to Section 5-5 “Notification of the Operating Status to the PC (Determining the NT20S Operating Status)” on page 196, “Screen Number Response” on page 205, and “8-digit Number Input Notify” on page 212.

**Caution:**

To ensure system safety, be sure to periodically read the PT operating status bit from the host in order to ensure that the PT is always operating normally.

4-3 Screen Display

This section describes the screen information required for the operation with the NT20S.

For details on how to change the displayed screen, refer to “Switching the Screen Display” on page 157, and “Display Specified Screen” on page 204. For the methods used to ascertain the screen number of the screen currently displayed, refer to “Notifying the Display Screen to the PC (To Display the Number of Currently Displayed Screen)” on page 160, and “Request Screen Number” on page 204.

4-3-1 Classification of Screens

The NT20S is provided with the following types of screens which are classified by the display method.

- Normal screen
- Overlapping screen
- Continuous screen

The screen type is set with each screen in the “Screen List” screen of the support tool. Select a screen type according to the purpose, and create characters and figures on the screen. In the case of the NT20S-ST128 (RS-232C), character strings and graphics can be also displayed in accordance with commands from the host, independently of the currently displayed screen. The details of each screen type are given below.

Normal Screen

A normal screen is the basic screen of the NT20S. It is not necessary to select a screen type (overlapping or consecutive) when to create the screen data on a normal screen.

When a normal screen is selected, existing screens will be erased and a normal screen will be displayed.

Overlapping Screen

Several normal screens can be overlapped and displayed as one screen. A group of overlapped screens is called an “overlapping screen”.

Several normal screens are displayed in the order of screen numbers which have been designated to each screen and form an overlapping screen. Up to eight screens can be overlapped to form one overlapping screen. The base screen used for making an overlapping screen is called a “parent screen”, and a bunch of screens which are laid over the parent screen are called “child screens”.

All display elements can be used on a parent screen.

The screen attributes such as a buzzer attribute set in the parent screen become effective in an overlapping screen.

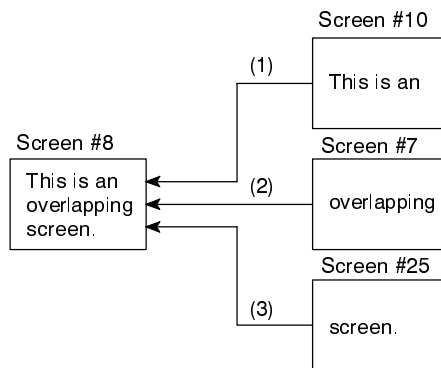
[Example overlapping screen]

- Parent screen: #8
- Child screens: #10, #7, and #25

When screen #8 is designated, screen #8 becomes the parent screen and the child screens #10, #7, and #25 are displayed over the parent screen in that order.

Only one numeral setting screen which allows numeric values to be set on the NT20S screen can be registered as a child screen. For the numeral setting, refer to Section 4-8 Numeral Setting (page 140).

Make sure that the touch switches and numbers set in the normal screens do not overlap in an overlapping screen. If the set positions of the touch switches and/or numbers in the normal screens overlap with each other, such settings may sometimes not be effective as intended. Use the support tool and make sure that the set positions do not overlap with each other.

Continuous Screens

A group of normal screens which are related in series and can be switched consecutively is called the “continuous screens”. Up to eight screens can be registered to one screen as a group of continuous screens.

The base screen used for registering the continuous screens is called a “parent screen”, and the registered continuous screens are called “child screens”.

The current screen number and the total number of continuous screens can be displayed in the top right corner of the screen. This is called the “page number display”.

The page number is set when creating the screen data by using the support tool. Refer to the “NT-series Support Tool Operation Manual” (V028-E1-□).

All display elements except “numeral setting” can be used in the continuous screens.

The screen attributes set in the parent screen become effective in the continuous screens.

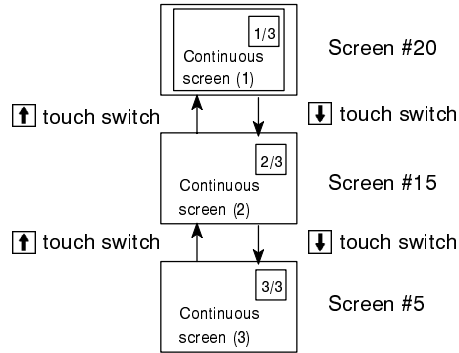

[Example continuous screens]





- Parent screen: #10
- Child screens: #20, #15, and #5

When screen #10 (continuous screen) is designated, screen #20 which is page 1 of the continuous screens will be displayed. Screen #15 or #5 can be displayed by using the touch switches. Since screen #10 has been set for the continuous screens, that screen cannot be displayed as an individual screen.

Switching the Continuous Screens by Using the Touch Switches

Continuous screens can be switched by using the  and  touch switches which have the system key functions.

When creating the screen, create touch switches  and  to which the system key functions are allocated. (Refer to “System key functions” (page 139).)

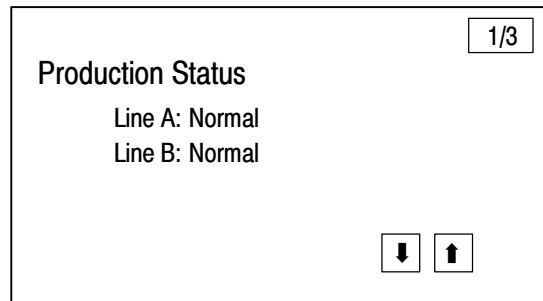

4-3-2 Screen Attributes

Each screen can be set with a specific function by designating a screen attribute, so that the specific function can be executed by displaying the screen. For example, by displaying a screen to which a “buzzer attribute” has been set, the buzzer of the NT20S starts sounding.

Set the screen attributes for each screen on the “screen selection” screen of the support tool.

Note that the support tool displays some items that are not used with the NT20S, such as “history attribute”, “alarm”, and “backlight color”.

The following several attributes can be set with one screen.

Buzzer Attribute

This attribute will become effective to sound the buzzer in the NT20S when the screen to which this attribute has been set is displayed. The buzzer sound can be set as follows:

- No: Buzzer does not sound when the screen is displayed.
- Continuous sound: Buzzer sounds continuously.
- Intermittent sound: Buzzer sounds intermittently at constant intervals.



The buzzer sound is set with the NT20S memory switch. The buzzer can also be set by using the Host. Refer to “Using the buzzer” (page 92) for the buzzer setting using the memory switch.

To stop the buzzer by using the screen operation, create a  system key as a touch switch.

Numeral Setting Attribute

Select whether the numeric keys are automatically displayed or the numeric keys are created at arbitrary positions on the numeral setting screen. The following two numeral setting attributes are used.

- System: The numeric keys registered to the system are automatically displayed.
- User: The numeric keys can be created at any arbitrary positions.

Reference: If the numeral setting attribute on the NT20S has been set for “system”, the touch switches [ENT],  and  which are allocated to the system besides the numeric keys need to be created. (System key functions (page 139))

Bit input attributes (applies to NT20S-ST128/RS232C only)

Select whether the touch switch number or bit information is notified to the host when the touch switch is pressed. There are two types of bit input attribute in the screen attributes, as indicated below:

- Off : Bit control when a touch switch is pressed is invalid. The status of the touch switch is notified using its number.
- Touch SW : Bit control when a touch switch is pressed is valid. The status of the touch switch is notified using bit information.

Backlight attributes

Select whether the backlight is lit or flashes when the screen is displayed. There are two types of backlight attribute in the screen attributes, as indicated below:

- Lit : Backlight is lit when the screen is displayed.
- Flashing : Backlight flashes when the screen is displayed.

4-4 Memory Tables

The NT20S has the “character-string memory table” for the character data and the “numeral memory table” for numeric data which can be written and updated by the PC/Host.

The contents of the memory tables can be set by using the support tool when displaying the memory tables on the screen or by editing the table.

4-4-1 Character-String Memory Table

The character-string memory table is an NT20S internal memory used to store the character data. Up to 128 character-string memory tables can be used, and up to 16 full size characters (32 bytes) can be stored in one memory table. The character-string memory tables at up to 32 positions can be registered in one screen.

Displaying a Character String

The character-string memory tables are registered with table numbers 0 to 127.

When creating the screen data by using the support tool, set the position on the screen to display a character string and also set a character string number to be displayed.

When the NT20S is operated, the screen displays the contents of the character-string memory table.

When using Ver.5 direct connection, it is possible to display the contents of character-string memory tables by specifying their numbers with numeral memory tables (indirect specification), rather than directly changing the character-string memory table contents.

For details on how to change currently displayed character strings, refer to “Changing Displayed Numerals or Character Strings (Changing the Contents of Allocated Words)” on page 169, and “Write Character-string Memory Table” on page 205.

When using the NT20S-ST128 (RS-232C), character strings can be also displayed in accordance with commands from the host, independently of the currently displayed screen (terminal function). Refer to “Specify Displayed Characters” on page 220.

Characters and Figures Which can be Displayed

The power of expression of the screen can be increased by giving various attributes such as the enlarged or reverse display to the characters of the character-string memory table.

The character attributes can be set in the edit screen when creating the screen data by using the support tool.

The following types of characters can be displayed on the NT20S:

Character Type	Dots (vertical x horizontal)	Character Set	Maximum Number of Characters Displayed in One Screen (without overwriting)
Half size characters	8 x 8	Alphanumerics and symbols	32 characters x 16 lines (512 characters)
Normal size characters	8 x 16	Alphanumerics and symbols	32 characters x 8 lines (256 characters)
Marks	16 x 16	Create by using the support tool	

- Enlarged display of the characters and marks

The characters and marks can be enlarged to the following scales.

Double width scale, Double height scale, x4 scale, x9 scale, x16 scale

- Smoothing

The characters and marks enlarged to the x4 scale or larger are displayed with the outline automatically smoothed. This function is called “smoothing”.

- Reverse and flashing display

Reverse display: The display brightness of the character and the background is reversed comparing with the normal display.

Flashing display: Characters are displayed as they flash. The normal display alternates with no-display.

Reverse and flashing display: The reverse display alternates with the normal display.

4-4-2 Numeral Memory Table

The numeral memory table is an NT20S internal memory used to store the numeral data. Up to 128 numeral memory tables can be used, and up to eight digits (four bytes) of numeral data (including signs) can be stored in one numeral memory table. The numeral memory tables at up to 50 positions can be registered in one screen.

Displaying a Numeral

The numeral memory tables are registered with table numbers 0 to 127.

When creating the screen data by using the support tool, set the position on the screen to display a numeral and also set a numeral number to be displayed.

When the NT20S is operated, the screen displays the contents of the numeral memory table.

- ➔ For details on how to change the currently displayed numeric data, refer to “Changing Displayed Numerals or Character Strings (Changing the Contents of Allocated Words)” on page 169, and “4-digit Write Numeral Memory Table” on page 206.

Numerals Which can be Displayed

The power of expression of the screen can be increased by giving various attributes such as the enlarged or reverse display to the numerals of the numeral memory table.

The numeral attributes can be set in the edit screen when creating the screen data by using the support tool.

- Digits of the whole numbers: 1 to 8 digits
- Digits of the decimal fraction: 0 to 7 digits
- Character sizes: Half, normal
- Enlarged display: Double width, double height, x4, x9, x16

The characters enlarged to the x4 scale or larger are displayed with the outline automatically smoothed. This function is called "smoothing".

- Display attribute: Normal, reverse, flashing, reverse and flashing
- Sign display setting
- Decimal/hexadecimal display setting
- Zero suppress setting

To display one numeral memory table on several different screens simultaneously, the display attributes on such screens must be the same. If there is discrepancies among the display attributes, the numeral table may not be displayed correctly.

Reference: Zero suppress setting

The numeral data are displayed in designated display areas as right-aligned. If the number of digits of a numeral data is smaller than that of the display area, number "0"s will be displayed at the vacant digits. These "0"s will not be displayed if the zero suppress setting is made for "Yes".

4-5 Bar Graphs

The contents of the numeral memory tables of the NT20S can be displayed as bar graphs as well as numeral data.

This section describes the bar graphs which can be displayed.

In order to change the data displayed in a bar graph, the contents of its numeral memory table have to be changed.

For details on how to update the data of a currently displayed bar graph, refer to "Upgrading Bar Graphs (Changing the Contents of Allocated Words)" on page 177, and "4-digit Write Numeral Memory Table" on page 206.

4-5-1 Bar Graph Functions

The bar graph function displays a value in a bar graph form as a percentage to the specified value according to the contents of a numeral memory table. Up to 50 bar graphs can be registered in one screen.

- Reference table

The numeral memory table used as the reference for the bar graph display can be set.

The support tool has the "direct" and "indirect" options for the reference method of the numeral memory table. However, the NT20S recognizes the "direct" method only.

The bar graph display cannot use hexadecimal numbers. If hexadecimal numbers are set in the reference numeral memory table, the bar graph cannot be displayed. Use caution not to write hexadecimal numbers except the minus sign "F" to the reference numeral memory table.

Bar Graph Attributes

The following attributes can be set with the NT20S for the bar graph display:

- Position and size

The display position and size (length) of a bar graph can be set.

The width of the bar graph can be set in the range of 2 to 255 dots.

- Orientation and incremental direction

The orientation and incremental direction of the bar graph can be selected from those mentioned below.

- ↑ (up): The bar graph increments upward in the vertical orientation.
- ↓ (down): The bar graph increments downward in the vertical orientation.
- ← (left): The bar graph increments to the left in the horizontal orientation.
- (right): The bar graph increments to the right in the horizontal orientation.

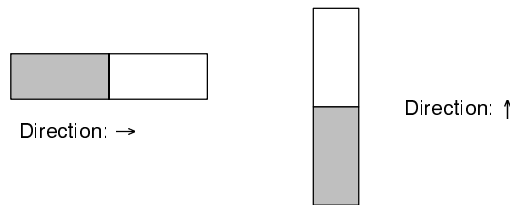

- Graph frame

Select whether or not the graph frame (boundary line of a graph display area) which indicates the effective display range is displayed.

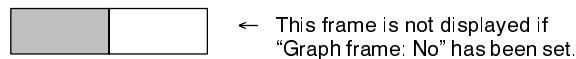

- Setting the 100 % value and % display

Set a value which corresponds to 100 % for the “100 % value”. The available value range is “0 to 99999999” (max. eight digits). For the “% display”, whether or not the proportion (percentage) of the reference numeral memory table value to the “100 % value” is displayed in a numeral can be selected. The display value is calculated as follows:

$$\text{“% display” value} = \text{Numeral memory table value} \div \text{“100 % value”} \times 100$$

For the font and attributes used for the numeral display, refer to “Numerals which can be displayed” (page 127).

- Sign display and display method

Select whether or not the bar graph which indicates a value below 0 % is displayed.

[To display a value below 0 %: Sign display “Yes”]

The bar graph is displayed in the range of -100 % to 100 %. The middle of the bar graph indicates 0 %.

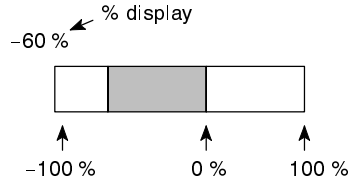

[Not to display a value below 0 %: Sign display “No”]

The bar graph is displayed in the range of 0 % to 100 %. The end of the bar graph indicates 0 %. Values below 0 % are indicated as 0 %.

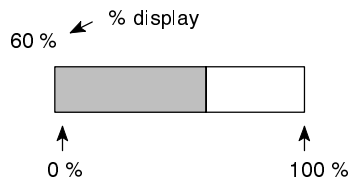

- Differences in the bar graph display method according to the % values

The bar graph display method varies according to the % value range.

- (1) When the % value is in the minus range

The display varies as follows according to the sign display setting:

Sign display “No”: Displayed as 0 %.

Sign display “Yes”: Displayed in the minus range.

- (2) When the absolute value of the % value is in the range of 100 % to 999 %

The % value is displayed as it is.

Sign display “No”: The display will be as mentioned below according to the graph frame setting.

When the frame is displayed:

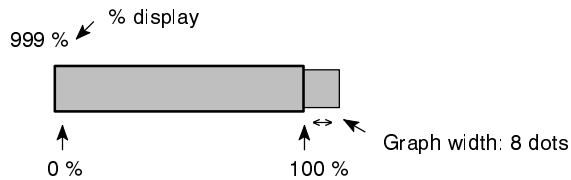

When the frame is not displayed:

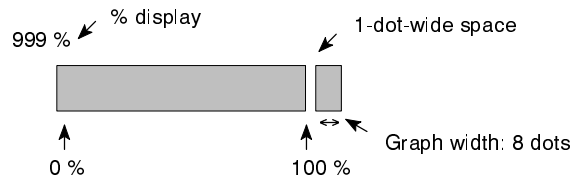

Sign display “Yes”: A value below -100% will be displayed in the minus direction as shown above.

- (3) When the absolute value of the % value is above 1000 %

The bar graph will be displayed the same as (2) above.

The % value is displayed as follows according to the sign display setting:

Sign display “No”: *** %

Sign display “Yes”: **** %

4-6 Lamps

The NT20S has the “lamp” function used to simply display the PC bit status.

This section describes the lamps which can be displayed.

The lamp display status (lit (flashing) or unlit) can be changed by instructions from the PC/host.

For details on how to change the status of a currently displayed lamp, refer to “Turning ON (lit) and OFF (unlit) the Lamps (Changing the Contents of Allocated Bits)” on page 179, “Lamp and Touch Switch Display (Bit Specification)” on page 210, and “Lamp and Touch Switch Display (Number Specification)” on page 210.

4-6-1 Lamp Functions

The lamps are the graphic areas whose method of display can be changed by using the PC. Available display methods are “lit”, “unlit”, and “flash”. Up to 128 lamps can be registered in one screen.

The display status (lit, unlit, and flashing) which are registered when creating the screen data can be switched according to the ON/OFF of the PC bit status.

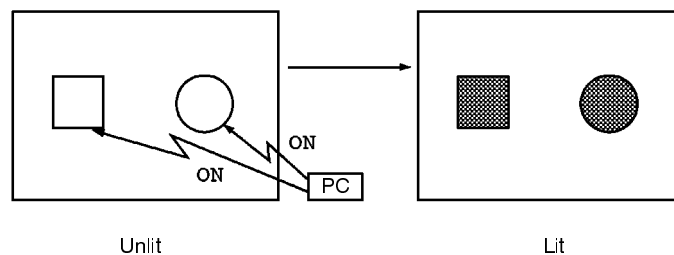

Lamp Attributes

The following attributes can be set with the lamp. Use the support tool to set the lamp attributes.

- Shape

Select from the square and circle shapes. The display size can be freely selected.

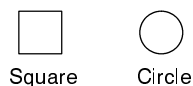

- Frame

Select whether or not the boundary line (frame) of the lamp display area is displayed. If the frame is not set, only the guide display message for the lamp is displayed when the lamp is not lit (or flashing). If the guide display message is not set, nothing is displayed.

- Lit and flashing

Select whether the lamp is lit (reverse display) or flashing (reverse flashing) when the lamp is turned ON by the PC.

- Guide display message

Lamps can be displayed with the guide display messages.

The guide display message attributes are the same as that for the “character display”. Refer to “Characters and Figures which can be Displayed” (page 126).

- Frame and lit/flashing

The display method of “lit/flashing” varies according to the frame setting.

Frame is set: Only the area in the frame will be lit/flashing.

Frame is not set: The area including the frame will be lit/flashing.

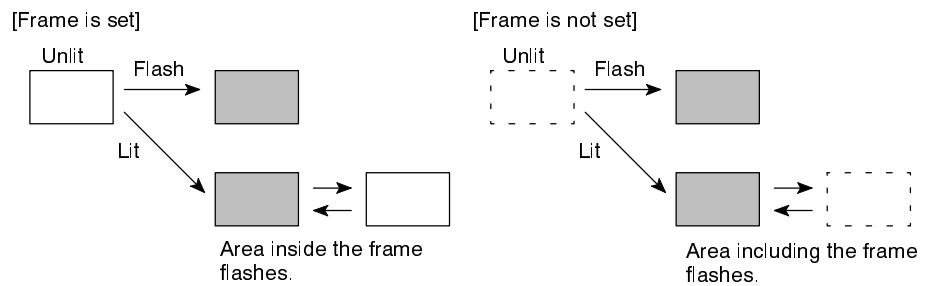

- Controlling the lamps in batch

More than one lamp can be lit or flashing in batch by registering those lamps to the same bit.

[Example of batch lighting]

Set the lamps L1 to L5 to the same bit number.



When a lamp is overlapped with a memory table display

The guide display message for a lamp is a fixed character-string. If you want to change the lamp guide display in accordance with some condition, overlap the display area of a numeral memory table or character-string memory table with the lamp. However, note that different results will be achieved depending on the timing of the lighting of the lamp and the updating of the memory table. Bear this in mind when creating the control program.

4-7 Touch Switches

The NT20S has a function whereby input operations can be performed by using touch panels displayed on the screen. NT20S screens can be switched, or bit information sent to the Host, by pressing (lightly touching) the “touch switches” in a panel.

The touch switches can also be made to light up (or flash) and go off like lamps. Touch switches are set when creating the screen data with the support tool.

This section describes the touch switches that can be displayed, and explains the screen switching function and the system key function.

For details on how the status of the currently displayed touch switch is notified to the Host, refer to “Lit (Flashing) and Unlit Touch Switch Statuses (Changing the Status of Allocated Bits)” on page 183, “Lamp and Touch Switch Display (Bit Specification)” on page 210, and “Lamp and Touch Switch display (Number Specification)” on page 210.

For details on how the statuses of touch switches are ascertained by the Host, refer to “Notifying the Host that a Switch has been Pressed (Determining Touch Switch Status)” on page 183, and “Lamp and Touch Switch Display Status Enquiry” on page 211.

⚠ Caution:

- Do not use input functions such as PT touch switches for applications where danger to human life or serious property damage is possible or for emergency switch applications.
- Press touch switches with a force of no greater than 30 N.
- Do not press touch switches carelessly while the backlight is off or while nothing is displayed on the screen. Otherwise the system may operate unpredictably. Only press touch switches after confirming system safety.
- If touch switches are pressed in rapid succession, their inputs may not be successfully received.
Confirm that the input of a touch switch has been successfully received before moving on to the next operation.

Reference: Caution on pressing touch switches at 3 points

When multiple touch switches are created at the relative positions indicated in the example below, malfunctions may occur due to the characteristics of this switch configuration.

Example 1: When switches are created at positions A and B and at the points where the vertical and horizontal lines extending from these two points intersect, i.e. points C and D:

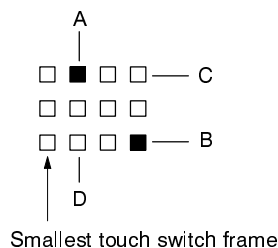

- When switches A, B, and C are switched on at the same time, switch D is also assumed to have been switched on due to the configuration of the touch switches.
- When switches A, B, and D are switched on at the same time, switch C is also assumed to have been switched on due to the configuration of the touch switches.

4-7-1 Functions of Touch Switches

Touch switches are created using rectangular elements measuring 19 dots horizontally by 19 dots vertically. A touch switch can comprise more than one touch switch element. Up to 72 touch switches (12 horizontally x 6 vertically) can be registered on one screen.

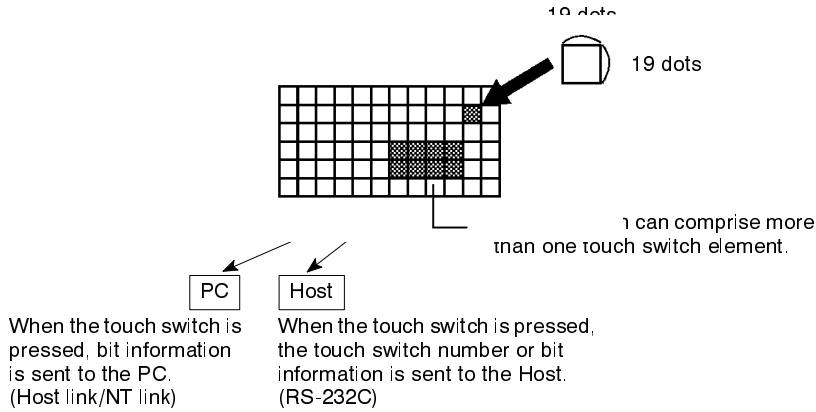

- Functions of touch switches

Touch switches can have the following functions:

- PC notification function
NT20S-ST121-EV3/ST122-V1
:Host link/NT link/C200H direct communication (page 183)
NT20S-ST128 :RS-232C (page 212)
- Screen switch (standalone) function (page 138)
- System key function (page 139)
- Numeral setting function
NT20S-ST121-EV3/ST122-V1
:Host link/NT link/C200H direct communication (page 188)
NT20S-ST128 :RS-232C (page 212)

Touch Switch Attributes

The following attributes can be set for touch switches.

- Display frame

The area that will respond as a touch switch is displayed in the form of a frame, as shown in the table below. One of three types of frame - standard, 3-D, and none - can be selected.

Type of Display Frame	Switch OFF	Switch ON
Standard		
3-D		
None		

If “none” is selected, only the touch switch’s guide display message (or nothing, if there is none) are displayed until a “light” or “flash” designation is sent from the PC/Host or the touch switch is pressed.

- Inverse display on input

It is possible to set a touch switch so that its display will be inverted when it is pressed.

- Lighting and flashing

It is possible to specify whether the touch switch will be lit continuously or flash when the bit allocated to it is turned ON by the PC/Host.

- Presence/absence of a guide display

A guide display message can be displayed at a touch switch location.

4-7-2 Screen Switching Function

The NT20S has a function that allows screens to be switched by pressing touch switches on its screen, rather than by designation from the PC/Host. This function is called the “standalone function”.

The screen number of the screen that will be displayed when a touch switch is pressed is set for that touch switch when the screen data is created using the support tool.

If the touch switch is pressed during operation, the screen whose number was designated will be displayed. Simultaneously, the PC/Host will be notified of the screen number of the screen selected for display.

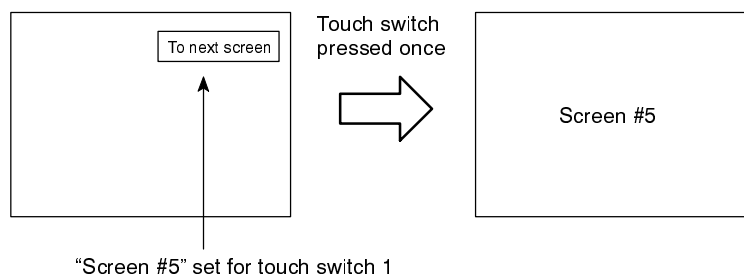

To set a screen number for a touch switch, use “Touch SW”, “Bit specification” and “Screen switch” of the support tool.

Note: Only one screen number can be set for one touch switch within one screen (or within one overlapping screen).

4-7-3 System Key Functions





The NT20S allows the allocation of “system key” functions to touch switches. The system key functions can then be used during operation by pressing the touch switches to which they have been allocated.

For example, if, when a screen for which buzzer sounding has been set is displayed, a  touch switch is also displayed, the buzzer can be stopped by pressing this touch switch.







To set a system key function for a touch switch, use “Touch SW”, “Bit specification” and “Numeric key” of the support tool.

Allocation of System Key Functions

The system key functions are allocated to touch switch numbers 227 to 230 and 255, as shown below. When a touch switch with one of these numbers is displayed on the screen, it has the same function as the corresponding system key.

System Key	Key Symbol	Touch Switch No.
System menu display	MENU	227
↑		228
↓		229
[Buzzer stop]		230
[ENT]		255

➡ When a touch switch to which a system key function has been allocated is pressed, the touch switch bit information is not notified to the PC.

The , , and  keys are not displayed among the system numeric keys. Accordingly, when using the system numeric keys, create the , , and  keys. Alternatively, create user numeric keys.

4-8 Numeral Setting

The NT20S has a “numeral setting” function to enable numerical values to be input from the screen. This function inputs numerical values to numeral memory tables in response to touch switch operations, displays these numerical values on the screen, and sends them to the host.

This section outlines the numeral setting function and the method for creating the ten keys required to set numerical values on the screen, and explains how to use ten keys during operation.

Numeral setting screens cannot be registered as child screens of continuous screens. In the case of overlapping screens, only one of the screens can be set as a numeral setting screen.

For details of the actual methods used to ascertain input numerical values at the PC side, refer to “Notification of Numbers to the PC” on page 188, and “Number Input Notify” on page 212.

Numeral settings are set during screen creation with the support tool.

⚠ Caution: Confirm system safety carefully before changing monitor data.

4-8-1 The Numeral Setting Function

The numeral setting function is described below.

Basic Procedure

The procedure for numeral setting is as follows.

- (1) Input the numerical value at the touch panel.
- (2) The input numerical value is displayed in the numeral setting area on the screen.
- (3) Confirm the input numerical value; it will be written to the numeral memory table, and simultaneously notified to the PC.

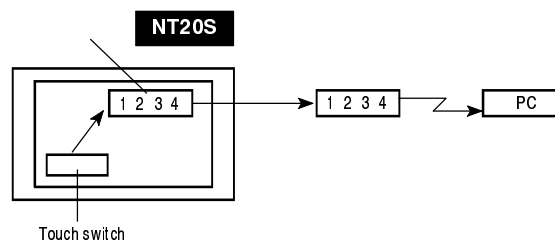

Restrictions on Numerical Value Input and Attribute Setting

Numerical values of up to 8 digits (7 if there is a minus sign) can be input in either decimal or hexadecimal format.

- Decimal input

When the display attribute is set for decimal display, values are input in the decimal format.

- Numerical value range

The range for numerical values that can be input differs according to whether or not there is a sign display.

When there is no sign display : 0 to 99999999 (8 digits)

When there is a sign display : -9999999 to +99999999
(7 digits for negative numbers,
8 digits for positive numbers)

If a sign is displayed when using the thumbwheel type of numeral setting, the maximum number of digits for both positive and negative numbers is 7.

- Decimal point

A maximum of 7 digits can be input after the decimal point (or 6 for negative numbers).

- Hexadecimal input

When the display attribute is set for hexadecimal display, values are input in the hexadecimal format.

- Numerical value range

Numerical values can be input in the range 0 to FFFFFFFF (8 digits).

- Attributes that can be set

The attributes of the numerical values displayed in the input field are the same as for numeral displays. See "Numerals Which can be Displayed" (page 127).

Upper/lower limit check (Ver.5 direct connection only)

When Ver.5 direct connection is used with an NT20S-ST121-EV3/ST122-V1, upper and lower limits can be set for input numerical values to prevent erroneous values that are outside the valid range being stored in the numeral memory table or notified to the PC.

The upper/lower limit check is executed when the input numerical value has been confirmed: if the value is outside the valid range, the screen returns to its status before input.

Correct Use: In order to use the numerical value input setting safely, always use the upper/lower limit check function. Since this function is not featured with NT20S-ST128 and Ver.4 and previous versions of the direct connection function, take appropriate measures using the user application software.

4-8-2 Types of Numerical Setting

There are two types of numeral setting: the numeric key type, and the thumbwheel type.

The basic function of these two types is the same, but the screen displays and input methods are different.

A maximum of 50 input fields, including both numeric key and thumbwheel types, can be registered on one screen.

The thumbwheel type of numeral setting can only be used when using Ver.5 direct connection with an NT20S-ST121-EV3/ST122-V1.

Numeric Key Type

When a numerical value is input using touch switches to which numeric key functions have been allocated, the input numerical value is displayed on the screen. On pressing the return key after completing input, the input numerical value is written to the numeral memory table and notified to the host.

If there is more than one numeral setting input field, the field in which the input is to be made can also be selected with the numeric keys.

In order to perform numeric key input, it is necessary not only to create a numeral setting input field on the screen, but also to create the numeric keys to be used for input (see page 143).

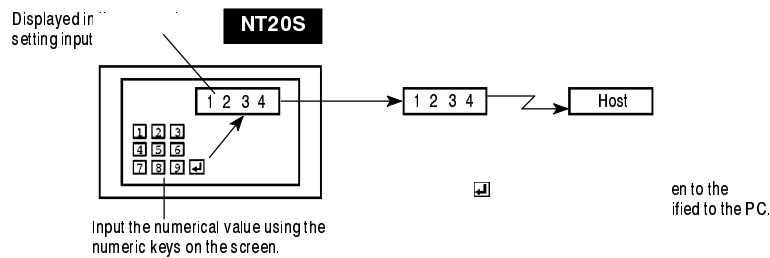

Thumbwheel Type (Ver.5 Direct Connection Only)

When using an NT-20S-ST121-EV3/ST122-V1 with Ver.5 direct connection, numerical values are input directly at the numeral setting input field using touch switches that increment or decrement each of the digits in the display when pressed. Each time the displayed numerical value is changed, the new displayed value is written to the numeral memory table and simultaneously notified to the host.

This means that, when using the Thumbwheel type of numeral setting, all that is required to input numerical values is to create the numeral setting input field on the screen.

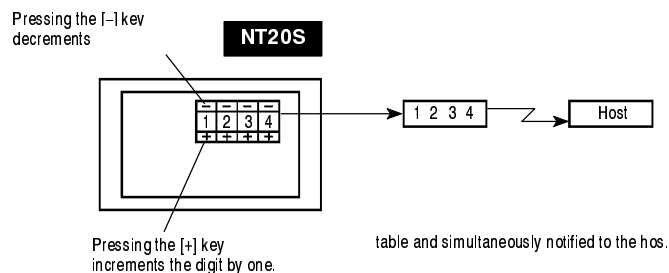

4-8-3 Creating Numeric Keys

In order to input numerical values using the numeral setting function, apart from the display area for the numeral setting, the numeric keys must also be created.

Setting Screen Attributes

The type of numeric keys can be selected using the numeral setting attributes of the screen attributes. There are two numeral setting attributes: “system” and “user”.

- Screen when “system” is specified

When a numeral setting area is created, numeric keys are automatically displayed. The display position and arrangement of the numeric keys are fixed. On this screen, only the types of numeric key shown in the figure below (system keys) are used.

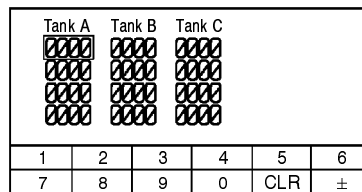

When using the NT20S with the numeral setting attribute set to “system”, apart from the numeric keys provided by the system, the touch switches allocated to system keys (⬇️, ⬆️, ⬇️) also have to be created (system key function). To enable input of hexadecimal values, it is also necessary to create numeric keys A through F.

With the NT20S, if the numeral setting attribute is set to “system”, apart from the numeric keys prepared by the system, the touch switches allocated to system keys (⬇️, ⬇️, ⬆️) have to be created. (“System key functions”, page 139)

- When the numeral setting attribute is “user”

The display position and arrangement of the numeric keys can be set as required by allocating them to touch switches (see page 125).

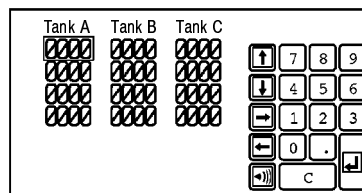

When the numeral setting attribute is set to “user”, numeric keys are created by using the control keys of the “input key” function. In addition, by using the character keys of the “input key” function, the one-byte characters 0 to 9 and A to F can be used as numeric keys.

Reference: Even when the numeral setting attribute is set to “user”, the same numeric keys as displayed with the “system” attribute can be displayed.
 If “User” is selected for “Keypad” during data creation on the numeral setting screen, the numeric keys shown below are displayed.

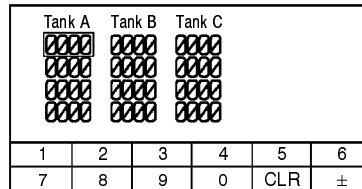

Numeric Key Allocations

The numeric keys are allocated to touch switches.

The numeric keys allocated to touch switches are specified when the touch switches are created. The following numeric keys (system keys) can be used for numeral setting.

For details on how to create touch switches, refer to 4-7 “Touch Switches” (page 136).

Touch Switch Number	Numeric Key	Touch Switch Number	Numeric Key	Touch Switch Number	Numeric Key
227 (*)	Menu display	237	6	247	CLR
228	↑	238	7	248	±
229	↓	239	8	249	.
230	⏪	240	9	250	HOME
231	0	241	A	251	↑
232	1	242	B	252	↓
233	2	243	C	253	←
234	3	244	D	254	→
235	4	245	E	255	↙
236	5	246	F		

(*) Numeric key number 227 is the system menu display key.

When the touch switches allocated as numeric keys and system keys on a numeral setting screen are pressed, no notification is made to the PC. This means that when using the NT20S-ST128 (RS-232C), the touch switches numbered 227 to 255 cannot be used as normal touch switches on a numeral setting screen.

4-8-4 Using Numeric Keys

To input numerical data by using numeric keys, first select the numeral setting area into which the value is to be input, then input the numerical value by pressing the appropriate numeric keys.

Selecting the Numeral Setting Area for Data Input

Select the numeral setting area into which the numerical value is to be input by using either the numeric keys or the system keys.

- Selection with the numeric keys

Use the [HOME], [→], [←], [↑] and [↓] keys. By using these keys, the cursor can be shifted between numeral setting areas in the way shown in the figure below.

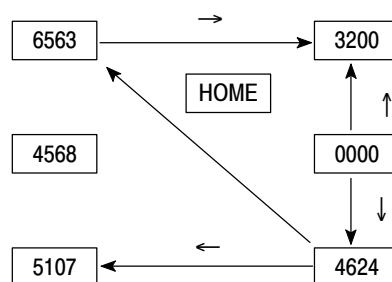

Pressing the [HOME] key will shift the cursor to the area whose top left corner has the smallest XY coordinate sum (the top left numeral setting input field in the example above).

- Selection with the system keys

When the [↑] and [↓] system keys on the touch panel are pressed, the cursor moves between the numeral setting areas by following the order in which they were created using the support tool.

For example, if three numeral setting areas have been created, the cursor can be moved between them following the order of creation as follows.

- ↑ key: 1st area → 2nd area → 3rd area → 1st area
- ↓ key: 1st area → 3rd area → 2nd area → 1st area

If the “numeral setting” screen attribute is set to “system”, the order of cursor motion when the [↑] and [↓] system keys are used can be changed. For details, refer to the NT series support tool operation manual (V028-E1-□).

Inputting Numerical Values Input numerical values using the following numeric keys (touch switches): numerals (0 to 9, A to F), decimal point (.), sign (+,-), clear (CLR), and return ().

When inputting a numerical value that includes a decimal point, input the integer and decimal fraction separately. First input the integer, then press the decimal point key (.) and input the decimal fraction.

If the integer or decimal fraction exceed their respective allowable numbers of display digits, they are shifted to the left. In the system keys, however, the decimal point key (.) is not included. Therefore, it is necessary to create the decimal point key (.) apart from the ten keys of the system keys to input a numerical value including decimal fraction.

- Changing the sign

When there is a sign display, pressing the sign (\pm) key changes minus to plus or plus to minus.

- Confirming input numerical values

Always press the return key as the final step when inputting a numerical value. When the return key is pressed, the displayed numerical value is written to the numeral memory table and at the same time notified to the host.

- Initial operation of input keys

The sign key (\pm), decimal point key (.), and alphabet key (A to F), operate as follows on initial use (first use after displaying the screen).

- Sign key (\pm)

The display is cleared to zero (assuming decimal input with sign display).

- Decimal point key (.)

The display is cleared to zero, after which input starts from the decimal fraction digits (assuming decimal input with sign display).

- Alphabet (A to F) key

The display is cleared to zero (assuming decimal input).

- Upper/lower limit check

When using an NT-20S-ST121-EV3/ST122-V1 with Ver.5 direct connection, when the return key is pressed after inputting a numerical value, an upper/lower limit check is executed. If the input numerical value is outside the valid range, the data in the numeral memory table before input is redisplayed and not notified to the host.

4-8-5 Using The Thumbwheel Type of Numeral Setting (Ver.5 Direct Connection Only)

When using the thumbwheel type of numeral setting, numerical values are input by directly touching the incrementing/decrementing (+/-) keys.

This type of input can only be used with Ver.5 of the direct connection function.

Numerical Value Input

Input numerical values by using the incrementing/decrementing (+, -) keys provided for each digit.

- Numerical value specification

When an incrementing/decrementing (+, -) key is touched, the numeral at the corresponding digit is incremented or decremented by one. Whenever a plus or minus key is touched, the changed value is notified to the host. There is no need to press the return key as is the case when using the numeric key type of numeral setting.

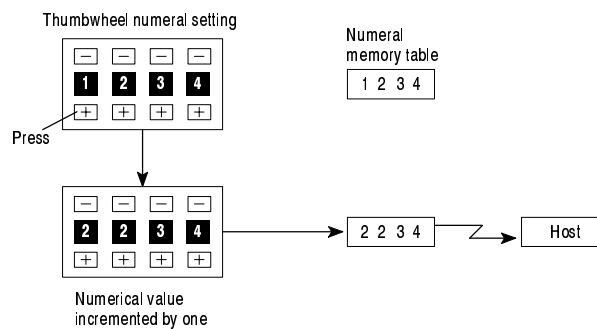

Numerical values cannot be set in thumbwheel type numeral setting fields by using numeric keys.

- Changing the sign

In settings with a sign display, touching the incrementing/decrementing (+, -) keys at the digit where the sign is displayed will change plus to minus and minus to plus.

- Upper/lower limit check

When using Ver.2 and later versions of the direct connection function, an upper/lower limit check is executed when the incrementing/decrementing (+, -) keys are pressed. If the input numerical value is outside the valid range, the data in the numeral memory table before the key was pressed is redisplayed and not notified to the host.

However, with thumbwheel type numeral setting, if the situation is such that with an upper limit of 1n..n, and a lower limit of 0m..m (where n and m are the values of each digit), $n..n < m..m$, it is not possible to carry digits upward or downward.

Example:

When the upper limit value is 1200 and the lower limit value is 201, if the initial value has three digits the value can be changed within the range 201 to 999, and if the initial value has four digits it can only be changed within the range 1000 to 1200.

This is because if an attempt is made to change the leftmost digit from 0 to 1, or from 1 to 0, an upper/lower limit value check is always performed.

In order to avoid this, either set the values so that $n..n \leq m..m$, or create another touch switch and write values to the host when digits are carried up or down.

4-8-6 Settings for Numeral Settings

The following settings are made for numeral settings during their creation with the support tool. Note that restrictions apply to several of the settings made for thumbwheel type numeral settings.

Settings

- Referenced numeral memory table

Set the number of the numeral memory table used to record the numerical value input using the numeral setting function.

- Number of digits in the input numerical value

Set the number of digits in the numerical values that can be input. A maximum of 8 digits (total of integer and decimal fraction parts) can be set. However, if there is a sign display, the maximum number of digits for negative values will be seven.

- Upper/lower limits (Ver.5 direct connection only)

Set the upper limit and lower limit separately. The maximum number of digits in the set values is eight (or seven if there is a sign display).

When the upper limit value and lower limit value are set as negative values, set "F" as the eighth digit.

Example: Upper limit value or lower limit value is "-123" → F0000123.

- Display attribute

Set attributes in the same way as for numeral display. For details, see Numerals Which can be Displayed (page 127).

Restrictions and Additional Settings for Thumbwheel Type Numeral Settings

There are the following restrictions and additional items to set when creating thumbwheel type numeral settings.

- Number of input digits for positive values when there is a sign display

When a sign display is set for a thumbwheel type numeral setting, a maximum of 7 digits can be input for positive values.

- Display size

One of two sizes can be selected: "small" in which each digit comprises two touch switch units, and "medium", in which each digit comprises three touch switch units. Note that if "small" is selected the area in which the numerical value is displayed is also the touch switch input area.

- Shape (end plates)

Set which of the two shapes shown below will be used. One has “end plates” at right and left sides and the other does not.

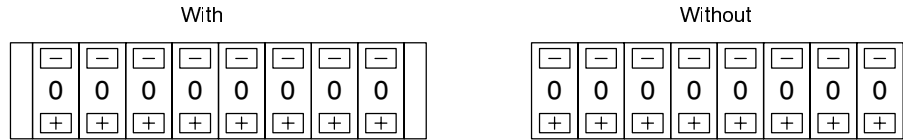

- Restrictions on display attributes

The following restrictions apply to display attributes.

- Character type : Wide size only
- Character enlargement : Standard only, regardless of the display size specification
- Zero suppress : No zero suppression only

See “Numerals Which can be Displayed” (page 127).

SECTION 5

How to Use the Host Link/NT Link

This Section describes in concrete terms how to use the Host link/NT link/C200H direct communication with the NT20S-ST121-EV3/ST122-V1.

5-1	Overview of Direct Connection Operations	152
5-1-1	Equipment and Settings Used in This Section	152
5-1-2	Allocatable Bits and Words	152
5-1-3	NT20S Status Control and Notification to PC	153
5-1-4	Switching the Screen Display	157
5-1-5	Notifying the Display Screen to the PC (To Display the Number of Currently Displayed Screen)	160
5-2	Memory Tables and Bar Graphs	163
5-2-1	Displaying the Contents of Allocated Words of Memory Tables	167
5-2-2	Changing Displayed Numerals or Character Strings (Changing the Contents of Allocated Words ... Direct Specification)	169
5-2-3	Changing Displayed Numerical Values or Character Strings (Changing the Contents of Allocated Words ... Indirect Specification)	171
5-2-4	Copying the Memory Table	174
5-2-5	Upgrading Bar Graphs (Changing the Contents of Allocated Words)	177
5-3	Lamps, Touch Switches, Numeral Setting	178
5-3-1	Allocation Bits and Display of Lamps	178
5-3-2	Turning ON (lit) and OFF (unlit) the Lamps (Changing the Contents of Allocated Bits)	179
5-3-3	Allocated Bits, and Display, of Touch Switches	181
5-3-4	Lit (Flashing) and Unlit Touch Switch Statuses (Changing the Status of Allocated Bits)	183
5-3-5	Notifying the Host that a Switch has been Pressed (Determining Touch Switch Status)	183
5-3-6	Notification of Numbers to the PC	188
5-4	NT20S Status Control	191
5-4-1	Controllable NT20S Functions	191
5-4-2	How to Control NT20S Functions	194
5-5	Notification of the Operating Status to the PC (Determining the NT20S Operating Status)	196
5-5-1	Ascertainable NT20S Statuses (Notified Operating Statuses)	196
5-5-2	Reading the NT20S Operating Statuses	197

5-1 Overview of Direct Connection Operations

This section explains allocated bits and words, control of the NT20S and PC notification methods, and the actual procedures used for switching screens, thereby providing the basic information required to use the NT20S-ST121-EV3 host link/NT link and NT20S-ST122-V1 (C200H direct communication).

5-1-1 Equipment and Settings Used in This Section

The following equipment and settings are used in the examples in this section:

[Equipment] PT : NT20S-ST121-EV3

PC : CQM1

Support tool : NT-series Support Tool Ver. 2.□

[Support tool settings]

PT type : NT20S

Memory capacity : 96 KB

Direct setting : Ver.5

Direct Macn Type : OMRON

5-1-2 Allocatable Bits and Words

When the host link/NT link is used, the following bits and words are allocated to the PC and used for the NT20S operation. The range of respective area varies with the type of PC. Refer to Appendix L PC Memory Map (page 278).

The allocations must be made without exceeding respective area range.

[OMRON PCs]

Symbol	C Series PCs				CVM1/CV Series PCs			
	Area Name	Allocated Bit	Allocated Word		Area Name	Allocated Bit	Allocated Word	
			Numeral	Character String			Numeral	Character String
DM	Data Memory	○	○	○	Data Memory	○	○	○
CH	Internal/Special Relay	○	○	○	Internal/Special Relay	○	○	○
TIM	Timer	×	△	×	Timer	×	△	×
CNT	Counter	×	△	×	Counter	×	△	×
HR	Holding Relay	○	○	○	-			
AR	Auxiliary Relay	○	○	○	Auxiliary Relay	○	○	×
LR	Link Relay	○	○	○	-			

○: OK △: 1 word only ×: NG

When allocating a memory table to words, the allocation must not exceed the word area.

Since the special auxiliary relays of the CV series PCs are allocated to the system, they cannot be used for purposes other than the system use. However, reading from them is possible.

Reference: One allocation word of the memory table can use continuous areas of up to 2 words in the case of numeral memory table or 16 words in the case of character string memory table.

5-1-3 NT20S Status Control and Notification to PC

The following describes the fundamentals of the display elements, NT20S status control, and notification which are the basics of the NT20S functions when using the host link/NT link.

For the detail method of use of the PT status control area and the PT status notify area, refer to Sections 5-4 NT20S Status Control (page 191) and 5-5 Notification of the Operating Status to the PC (Determining the NT20S Operating Status) (page 196).

Controlling the Display Elements by Using Allocated Bits and Words

The NT20S will operate as follows in the display element control operation.

[NT20S operation]

- (1) The NT20S checks the allocation bits and words of the display elements and makes an inquiry to the PC.
- (2) The PC answers the NT20S about the bit and word data.
- (3) The NT20S changes the display status according to the bits and words obtained from the PC.

[NT20S operation example]

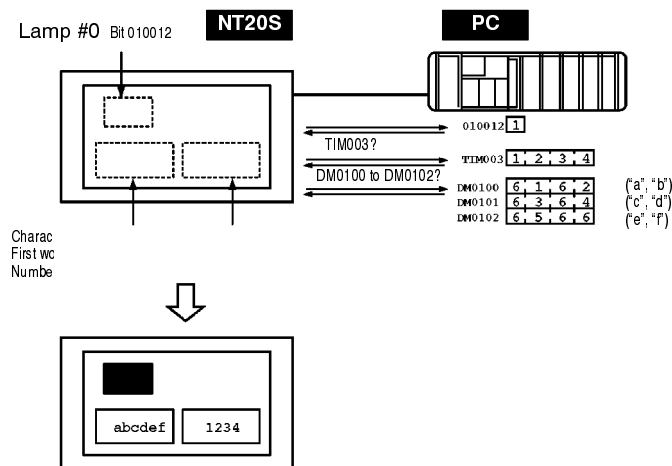

Controlling the NT20S Status by Using Allocated Bits and Words PT Status Control Area (PC to PT)

The PT status control area (PC to PT) is provided to control the NT20S status from the PC. When data is written to this area in the PC, the NT20S will read the data and operates according to the data. The PT status control area is configured as four consecutive words as shown below.

	Word 15	14	13	12	11	10	9	8	7	6	5	4	3	2	1	0	Bit
n	Screen # (4-digit BCD)																Screen switch setting
n+1	0		Copy source memory table # (3-digit BCD)														Copy memory table setting
n+2	Copy type		Copy destination memory table # (3-digit BCD)														
n+3	PT status control bit								0				0				PT status control

The first word (word n) of the PT status control area must be set with the support tool.

- Screen switch settings (refer to page 157)
 - Specify the screen # to switch the screen displayed on the NT20S.
- Copy memory table settings (refer to page 174)
 - Specify the memory table # to copy the contents of a memory table internally in the NT20S.
 - Set the copy type to match the type of memory table to be copied:
 - 0: Character-string memory table
 - 1: Numeral memory table
- PT status control bits (refer to page 191)

These bits are switched ON and OFF to control the NT20S buzzer and backlight.

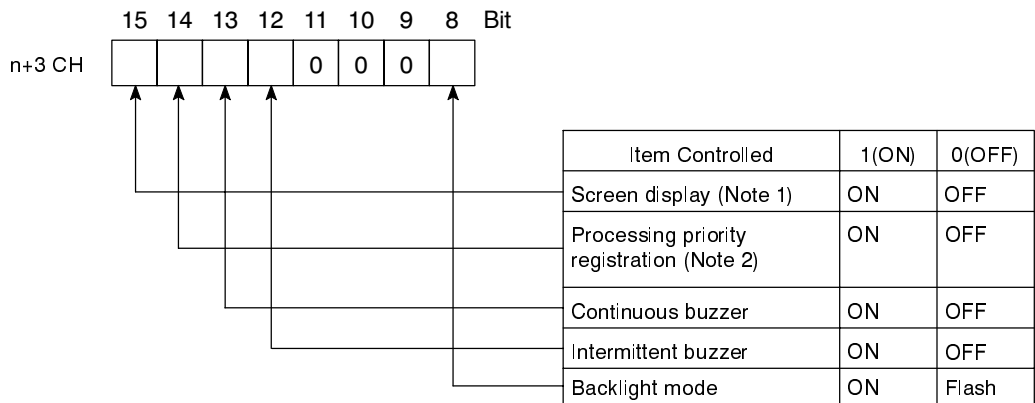

Note 1:When "ON" is set for screen display, the backlight is on; when "OFF" is set for screen display, the backlight is off.

Note 2:Priority registration is only valid when NT link (1:N) is set.

The PT status control area (PC to PT) can be allocated to the following PC areas.

Symbol	C Series PCs	Allocated	CVM1/CV Series PCs	Allocated
DM	Data Memory	○	Data Memory	○
CH	Internal/Special Relay	○	Internal/Special Relay	○
TIM	Timer	×	Timer	×
CNT	Counter	×	Counter	×
HR	Holding Relay	○	-	
AR	Auxiliary Relay	○	Auxiliary Relay	×
LR	Link Relay	○	-	

○: OK ×: NG

Since the special auxiliary relays of the CV series PCs are allocated to the system, they cannot be used for purposes other than the system use.

Correct Use: Make sure there is no duplication in the PT status control area allocations and PT status notify area allocations.

Reference: When NT link (1:N) is set, the PT status control area must be set for each connected PT.

Notifying the Display Elements by Using Allocated Bits and Words

The NT20S will operate as follows in the display element notification operation.

[NT20S operation]

The NT20S will write any changes in the contents of the numeral or character-string memory table being displayed or pressing of a touch switch to the bits and words area in the PC.

[NT20S operation example]

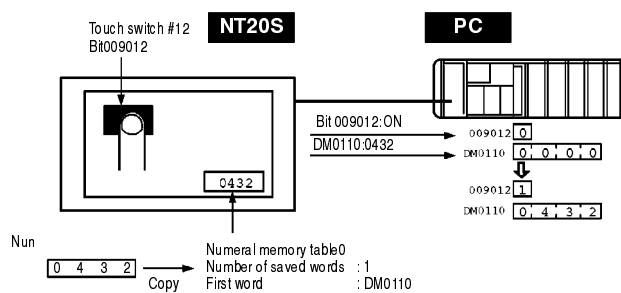

Notifying the NT20S Status by Using Allocated Bits and Words PT Status Notify Area (PT to PC)

The PT status notify area (PT to PC) is provided to notify the NT20S status changes to the PC. When any NT20S status has changed, such change is written to this area in the PC, and the PC will read the data from this area to check the NT20S status.

The PT status notify area is configured as three consecutive words as shown below.

Word	15	14	13	12	11	10	9	8	7	6	5	4	3	2	1	0	Bit
m	Screen # (4-digit BCD)															Screen being displayed	
m+1	0			Numeral memory table # (3-digit BCD)												Content upgrade memory table	
m+2	PT status					0			0							PT status	

The first word (word m) of the PT status notify area must be set with the support tool.

- Currently displayed screen (refer to page 160)

The screen number displayed on the NT20S is written to this word.

Simultaneously, the PT status screen switch strobe flag is set to ON (1). After this is notified to the PC, this flag reverts to OFF (0). Checking the status of this flag will provide a simple method of checking if the NT20S display has switched.

- Content upgrade memory table (refer to page 188)

The number of the numeral memory table is written to the word when the numeral memory table contents change due to the touch switch operation on the NT20S.

As the number of the numeral table is written, the PT status numeral setting strobe flag is simultaneously set ON (1). After this is notified to the PC, this flag reverts to OFF (0). Checking the status of this flag will provide a simple method of checking if a number has been input from the NT20S.

Note that this function is not available with the character-string memory table.

- PT status (refer to page 196)

The NT20S operation status and other information are written with the ON or OFF of the bits as shown below.

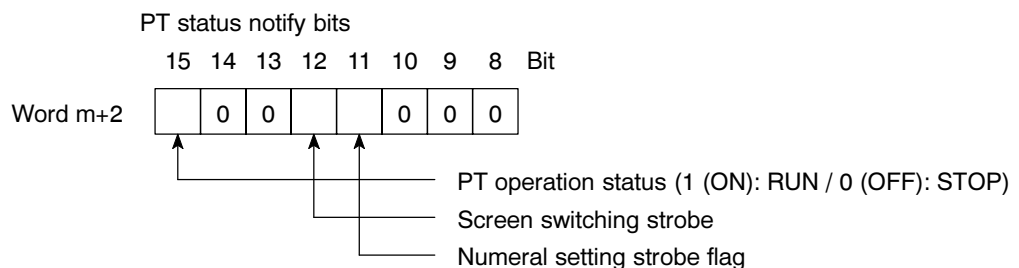

The PT status control area (PC to PT) can be allocated to the following PC areas.

Symbol	C Series PCs	Allocated	CVM1/CV Series PCs	Allocated
DM	Data Memory	○	Data Memory	○
CH	Internal/Special Relay	○	Internal/Special Relay	○
TIM	Timer	×	Timer	×
CNT	Counter	×	Counter	×
HR	Holding Relay	○	-	
AR	Auxiliary Relay	○	Auxiliary Relay	×
LR	Link Relay	○	-	

○: OK ×: NG

Since the special auxiliary relays of the CVM1/CV series PCs are allocated to the system, they cannot be used for purposes other than the system use.

Correct Use: Make sure there is no duplication in the PT status control area allocations and PT status notify area allocations.

Reference: When NT link (1:N) is set, the PT status control area must be set for each connected PT.

5-1-4 Switching the Screen Display

The following describes the procedure used to switch the NT20S screen display by controlling from the PC.

Reference: The display screen can be switched also by pressing a touch switch during the operation after registering a screen number to the touch switch. For this function, refer to the “Standalone Function” (page 138).

To switch the NT20S screen display by controlling from the PC, write a screen number at the “screen switch setting” in the PT status control area.

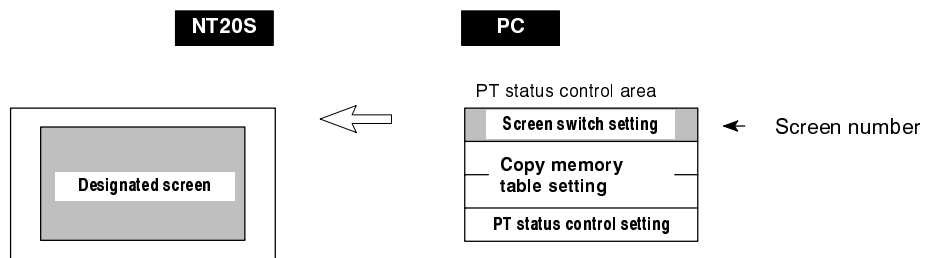

[Screen switch setting in the PT status control area]

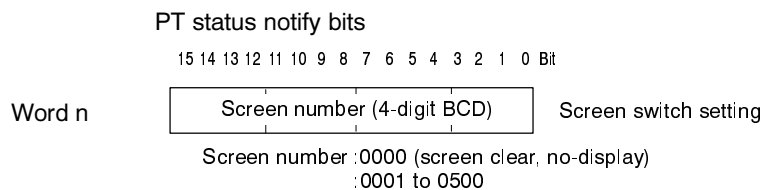

- Available allocation words

The PT status control area (PC to PT) can be allocated to the following PC areas.

Symbol	C Series PCs	Allocated	CVM1/CV Series PCs	Allocated
DM	Data Memory	○	Data Memory	○
CH	Internal/Special Relay	○	Internal/Special Relay	○
TIM	Timer	×	Timer	×
CNT	Counter	×	Counter	×
HR	Holding Relay	○	-	
AR	Auxiliary Relay	○	Auxiliary Relay	×
LR	Link Relay	○	-	

○: OK ×: NG

Since the special auxiliary relays of the CVM1/CV series PCs are allocated to the system, they cannot be used for purposes other than the system use. The range of respective area varies with the type of PC. Refer to Appendix L PC Memory Map (page 278).

- Procedure**
1. Use the support tool to allocate the PT status control area (PC to PT) to the PC memory.
 2. Create a PC program to write the number of the displayed screen to the “screen switch setting word” in the PT status control area.

Use a 4-digit BCD (binary-coded decimal) value to set a screen number.

If a screen has been switched by operating the PT status control area (PC to PT), the contents of the “currently displayed screen word” in the PT status notify area (PT to PC) also change.

- Screen switching timing

The NT20S screen switches when the contents of the “screen switch setting” have changed. To re-specify the number of the currently specified screen, first write the value 0000 to clear the screen before writing the appropriate screen number.

- Use of the screen switching strobe

Create a program to read the number of the currently displayed screen and to write the number to the “screen switch setting word” at the leading edge of the “screen switching strobe” of the PT status notify area. This program enables screen switching by using the touch switches on the NT20S and eliminates repeated setting of the same screen number. If the screen switching is not executed on the NT20S, the screen switching strobe does not need to be checked.

For the screen switching strobe, refer to the “notifying the displayed screen to the PC” mentioned below.

- Continuous screens and overlapping screens

Continuous or overlapping screens can be displayed by designating the parent screen. If a child screen is designated, only the child screen is displayed.

For the continuous and overlapping screens, refer to the “Classification of Screens” (page 122).

Example of Display Screen Switching

This example operates the PC switch (bit) to switch the NT20S display screen.

- Support tool settings

Make the following settings with the support tool:

PT status control area: Word 0100

PT status notify area: Word 0110

Screen number to be created: Screen #2 and #3

- PC ladder program

Create a PC ladder program as follows:

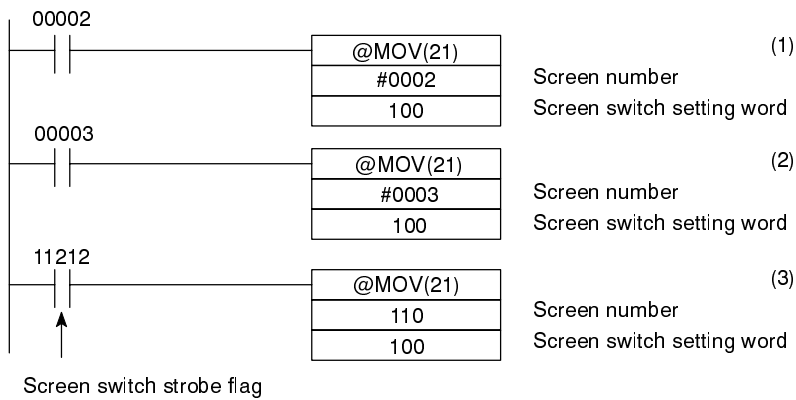

- Program operation

(1) Screen #2 is displayed on the NT20S when bit 00002 turns ON.

(2) Screen #3 is displayed on the NT20S when bit 00003 turns ON.

(3) When the screen switch strobe flag turns ON, the number of the currently displayed screen is read and written to the currently displayed screen word in the PT status notify area. In this case, the NT20S will not write the same screen twice.

5-1-5 Notifying the Display Screen to the PC (To Display the Number of Currently Displayed Screen)

The following describes the processing to display the number of currently displayed screen of the NT20S.

This processing reads the data from the PC status notify area.

To indicate that the screen has switched, use the screen switch strobe flag.

To display the number of the currently displayed screen, use the currently displayed screen word.

When the screen has switched, the NT20S notifies the following to PT status notify area (PT to PC) allocated to the PC.

- Screen switch notification: Screen switch strobe flag of the PT status word
- New screen number: Currently displayed screen word

By reading the currently displayed screen word when the screen switch strobe flag has turned ON, the number of the currently displayed screen on the NT20S is displayed.

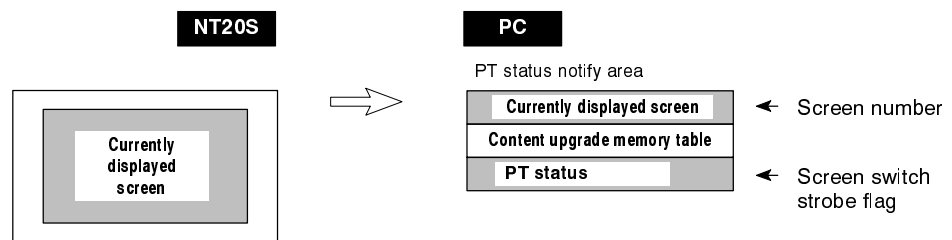

[Currently displayed screen] and [PT status] words in the PT status notify area

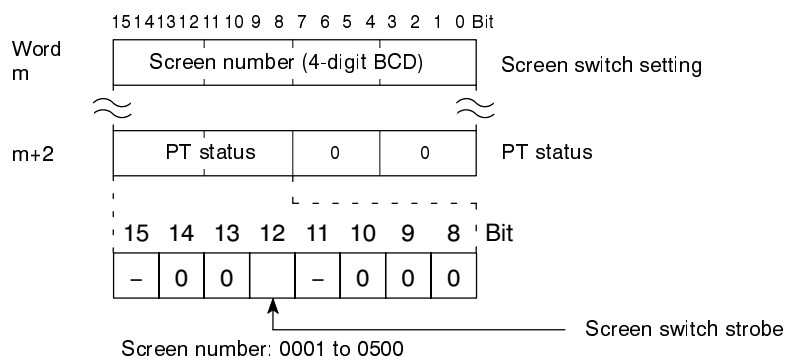

Use a 4-digit BCD (binary-coded decimal) value to set a screen number.

The screen switch strobe bit reverts to OFF (0) after this is notified to the PC.

- Available allocation words

The PT status notify area (PT to PC) can be allocated to the following PC areas.

Symbol	C Series PCs	Allocated	CVM1/CV Series PCs	Allocated
DM	Data Memory	○	Data Memory	○
CH	Internal/Special Relay	○	Internal/Special Relay	○
TIM	Timer	×	Timer	×
CNT	Counter	×	Counter	×
HR	Holding Relay	○	-	
AR	Auxiliary Relay	○	Auxiliary Relay	×
LR	Link Relay	○	-	

○: OK ×: NG

Since the special auxiliary relays of the CV series PCs are allocated to the system, they cannot be used for purposes other than the system use.

The range of respective area varies with the type of PC. Refer to Appendix L PC Memory Map (page 278).

- Procedure**
1. Use the support tool to allocate the PT status notify area (PT to PC) to the PC memory.
 2. Create a PC program to read the “currently displayed screen word” in the in the PT status notify area when the “screen switch strobe flag” in the PT status notify area has turned ON.

Reference: The contents of the “currently displayed screen word” are updated also by switching the screen by pressing a touch switch on the NT20S.

For this function (standalone function or screen switch function), refer to the “Standalone Function” (page 138).

- Continuous screens and overlapping screens

When a continuous or overlapping screen is displayed, the number of the parent screen is written to the “currently displayed screen word”.

For the continuous and overlapping screens, refer to the “Classification of Screens” (page 122).

Example of Reading the Number of Currently Display Screen

This example gives a PC program that reads the screen number each time the screen is switched. In this example, the number of the previous screen is also stored.

- Support tool settings

Make the following settings with the support tool:

PT status notify area: Word 0110

- PC ladder program

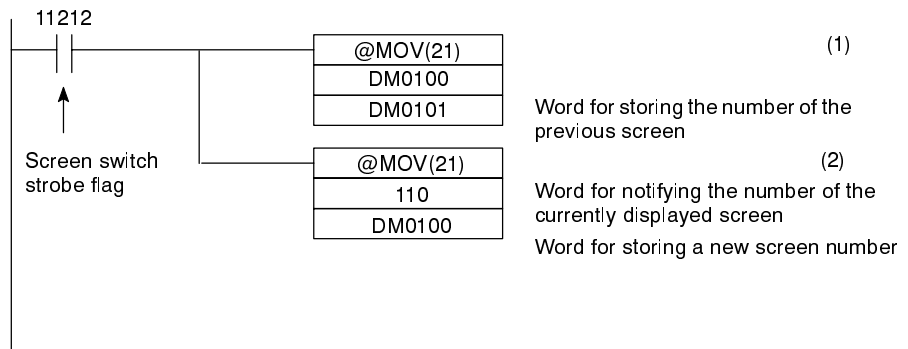

- Program operation

- (1) When the NT20S screen display switches and the screen switch strobe flag (bit 11212) turns ON, the contents of DM0100 are transferred to DM0101. The number of the previously displayed screen is stored in word 0101.
- (2) The new screen number notified by the NT20S is read and transferred to DM0100. The number of the currently displayed screen is stored in DM0100.

5-2 Memory Tables and Bar Graphs

Displaying and Referencing Character String Memory Table Contents

Since the character-string memory tables can be allocated to the words in the PC, the PC can write data to the character-string memory tables or the initial values can be set when creating the screen data.

Automatic updating is performed to ensure that the currently displayed NT20S character string memory table contents and PC word contents always match each other.

There are two methods for referencing character string memory tables used for character string display, as follows:

- Direct specification
- Indirect specification (with Ver.5 direct connection only)
- Direct specification

Direct specification is a method of specification in which the contents of displayed memory tables are directly correlated with the contents of the allocated words.

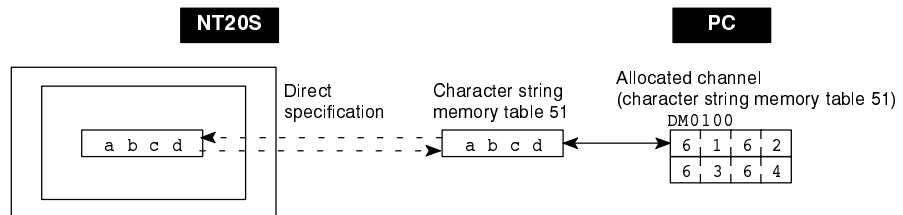

- Indirect specification (with Ver.5 direct connection only)

In indirect specification, even if the displayed data is a character string, the display is correlated with a numeral memory table. The contents (numerical value) of this numeral memory table are regarded as a character string memory number and the contents of the table with this number are displayed.

Up to 50 numeral displays and 50 character string displays can be specified on one screen by using indirect specification.

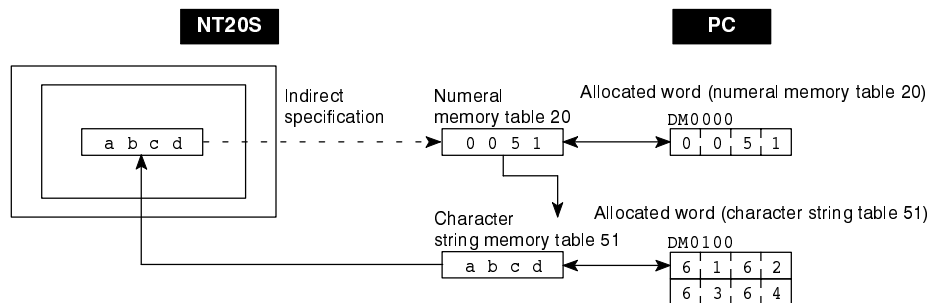

This specification method is a little complex, but it allows the display to be changed more easily according to the circumstances. In the example above, if 1 were added to the contents of memory table 20 to give 52, the contents of memory table 52 would be displayed instead.

The memory tables used for display can also be allocated to areas in the PC, so that the display can also be changed in response to changes in the data to be displayed (i.e., the contents of character string memory table 51 in the example above).

However, in comparison with direct specification, indirect specification requires more time for processing.

Setting the Words of the Character-String Memory Table

When creating the screen data by using the support tool, make the following settings for each numbered character string:

- Initialization setting

Set whether or not the PC words are initialized with the character-string memory table initial value registered to the screen data memory when the main power supply is turned ON or reset.

- Number of registration words

Set the number of words within 16 words required for registering the character-string data. One word can store two normal-size characters.

- Setting the words for the character-string memory tables

The character-string memory tables can be allocated to the following PC words. Set the word type and the first word.

Symbol	C Series PCs	Allocated	CVM1/CV Series PCs	Allocated
DM	Data Memory	○	Data Memory	○
CH	Internal/Special Relay	○	Internal/Special Relay	○
TIM	Timer	×	Timer	×
CNT	Counter	×	Counter	×
HR	Holding Relay	○	–	
AR	Auxiliary Relay	○	Auxiliary Relay	×
LR	Link Relay	○	–	

○: OK ×: NG

Since the special auxiliary relays of the CVM1/CV series PCs are allocated to the system, they cannot be used for purposes other than the system use.

If the “number of registration words x 2” (“word setting window”) set with the support tool is larger than the “number of character digits” (“character-string display setting” window), the character string may be broken halfway.

The range of respective area varies with the type of PC. Refer to Appendix L PC Memory Map (page 278).

Displaying and Referencing Numeral Memory Table Contents

Since the numeral memory tables can be allocated to the words in the PC, the PC can write data to the numeral memory tables or the initial values can be set when creating the screen data.

Also, by relating the numeral memory tables with the bar graphs, the bar graphs corresponding to the data of the numeral memory tables can be displayed.

During the operation, the display contents are automatically updated so that the contents of the numeral memory table being displayed are the same as that of the PC word.

There are two methods for referencing numeral memory tables used for numeral displays, as follows:

- Direct specification
- Indirect specification (with Ver.5 direct connection only)

Reference: The only method available for numeral memory tables used for graphs and numeral settings is direct specification.

- Direct specification

Direct specification is a method of specification in which the contents of displayed memory tables are directly correlated with the contents of the allocated words.

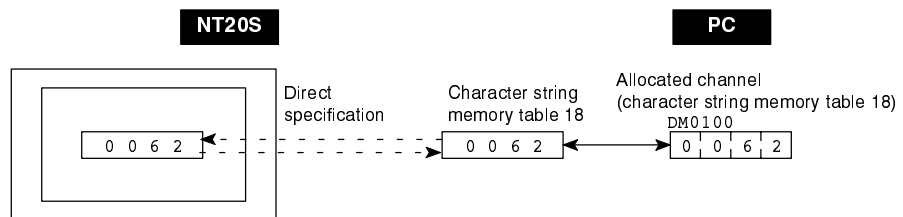

- Indirect specification (with Ver.5 direct connection only)

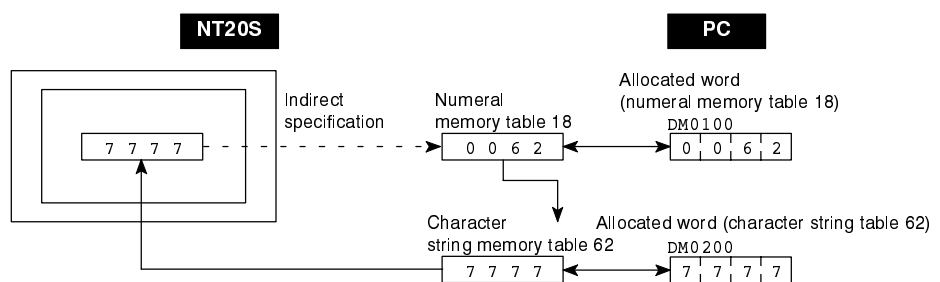

In indirect specification, the contents (numerical value) of the specified numeral memory table are regarded as a memory table number and the contents of the table with this number are displayed.

Up to 50 numeral displays and 50 character string displays can be specified on one screen by using indirect specification.

This specification method is a little complex, but it allows the display to be changed more easily according to the circumstances. In the example above, if one were added to the contents of memory table 18 to give 63, the contents of memory table 63 would be displayed instead.

The memory tables used for display can also be allocated to areas in the PC, so that the display can also be changed in response to changes in the data to be displayed (i.e., the contents of character string memory table 62 in the example above).

However, in comparison with direct specification, indirect specification requires more time for processing.

Setting the Words of the Numeral Memory Table

When creating the screen data by using the support tool, make the following settings for each numbered numeral:

- Initialization setting

Set whether or not the PC words are initialized with the numeral memory table initial value registered to the screen data memory when the main power supply is turned ON or reset.

- Number of registration words

Set the number of words within 2 words required for registering the numeral data. One word can store up to 4 digits. Two words can store up to 8 digits.

- Setting the words for the numeral memory tables

The numeral memory tables can be allocated to the following PC words. Set the word type and the first word.

Symbol	C Series PCs	Allocated	CVM1/CV Series PCs	Allocated
DM	Data Memory	○	Data Memory	○
CH	Internal/Special Relay	○	Internal/Special Relay	○
TIM	Timer	△	Timer	△
CNT	Counter	△	Counter	△
HR	Holding Relay	○	–	
AR	Auxiliary Relay	○	Auxiliary Relay	×
LR	Link Relay	○	–	

○: OK △: 1 word only ×: NG

Since the special auxiliary relays of the CVM1/CV series PCs are allocated to the system, they cannot be used for purposes other than the system use.

The range of respective area varies with the type of PC. Refer to Appendix L PC Memory Map (page 278).

5-2-1 Displaying the Contents of Allocated Words of Memory Tables

The relationship between the contents of the allocated words of numeral and character string memory tables and the display is described below.

- Contents of the numeral memory tables

Numerals are stored in the allocated words as shown below.

[Stored as a single word]

15	to	12	11	to	8	7	to	4	3	to	0	Bit
Digit 4	Digit 3	Digit 2	Digit 1									

Example: 1234

15	to	12	11	to	8	7	to	4	3	to	0	Bit
1	2	3	4									

[Stored as a double words]

Word	15	to	12	11	to	8	7	to	4	3	to	0	Bit
Start	Digit 4	Digit 3	Digit 2	Digit 1									
Start+ 1	Digit 8	Digit 7	Digit 6	Digit 5									

Example: 12345678

Word	15	to	12	11	to	8	7	to	4	3	to	0	Bit
Start	5	6	7	8									
Start+ 1	1	2	3	4									

- Displaying the numeral memory table

Numerals can be displayed in three different ways according to the contents of the numeral memory table, as mentioned below.

The most significant digit (digit 4 of a single word or digit 8 of a double word) is processed in different ways.

Hexadecimal display: All digits are handled as stored in the allocated words.

Decimal display without signs: If the most significant digit is "F", it is handled as "0", and the most significant digit other than "F" and other digits are handled as stored in the allocated words.

Decimal display with signs: If the most significant digit is "F", it is handled as "-" (minus sign), and the most significant digit other than "F" and other digits are handled as stored in the allocated words.

[Numeral memory table display examples]

- When the data are numeral data (0 to 9)

Start	3 4 5 6	→	Decimal without sign	123456
Start + 1	F 0 1 2		Decimal with sign	-123456
			Hexadecimal	F0123456

- When the data contain characters (A to F)

Start	3 B 5 6	→	Decimal without sign	123B56
Start + 1	F 0 1 2		Decimal with sign	-123B56
			Hexadecimal	F0123B56

If the hexadecimal data (A to F) are stored when the decimal display has been set, the alphabets are displayed.

If the number of display digits has been set to be smaller than the maximum number of digits of the registration words (4 digits for 1 word; 8 digits for 2 words), the contents of the allocated words are not displayed and “*” symbols will be displayed at all digits.

If the most significant digit is “F” when “decimal with signs” has been set, the numeral is handled as a negative number. The maximum number of digits of the negative number becomes smaller than that of the positive number by 1 digit.

The actual display will vary according to the “zero suppress” setting and decimal fraction setting as well as the contents mentioned above. Refer to the “NT-series Support Tool Operation Manual” (V028-E1-□).

- Contents of the character-string memory table

A character string is stored in the allocated words beginning with the first word in normal-size characters.

Two normal-size characters are stored in one word. One memory table can store up to 16 words (32 characters).

Start	Start + 1		Start + 15
Code 1 Code 2	Code 3 Code 4		Code31 Code32

[Character-string memory table display example]

To display the characters in order, allocate the characters as follows.

“A”=41H, “B”=42H	Start	4 1 4 2	→	“ABCDEFGH”
“C”=43H, “D”=44H	Start + 1	4 3 4 4		
“E”=45H, “F”=46H	Start + 2	4 5 4 6		
“G”=47H, “G”=48H	Start + 3	4 7 4 8		

5-2-2 Changing Displayed Numerals or Character Strings (Changing the Contents of Allocated Words ... Direct Specification)

The following explains the actual procedure for changing the contents of allocated words referenced by direct specification in order to change numerical values and character strings displayed by the NT20S.

For the situation when using indirect specification, see “Changing Displayed Numerals Values or Character Strings (Changing the Contents of Allocated Words ... Indirect Specification)” (page 171).

Numerals and character strings can be changed also by making a copy of the memory tables. Refer to “Copying the memory table” explained later.

To change the numerals or character strings displayed on the NT20S, make changes with the numeral or character-string memory table. To make changes with the numeral or character-string memory table of the NT20S, change the contents of words by the PC.

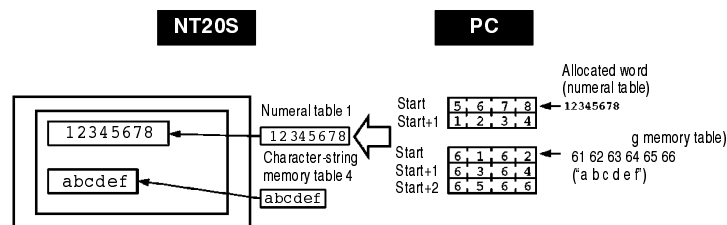

Reference: This method is convenient when changing data has to be displayed: for example when monitoring the contents of PC words.

- Procedure**
1. Use the support tool to allocate the numeral and character-string memory tables to the PC memory.
 2. Register the memory tables for the numerals and character strings to be displayed when creating the screen data by using the support tool. Specify “direct” as the reference method.

To display a character string, use “character display” and specify the character-string memory table by using the support tool.

To display numerals, use “numeral display” and specify the numeral memory table by using the support tool.

3. Create a PC program to write the contents of numerals and character strings to be displayed on the NT20S to the PC words.
- Important points when writing a character string

If a character string to be written is smaller than “allocated word x 2”, fill up the vacant space with normal-size spaces (20H). If unnecessary characters are left in the area, the character string will not be displayed correctly.

Application Example of the Numeral Memory Tables Allocated to the PC Words

This example gives the procedure to directly display the contents of the words allocated as the numeral memory tables in the PC memory. The NT20S screen display will change as the contents of the PC word change.

- Support tool settings

Allocate the memory as shown below by using the support tool.

Numeral memory table entry #1: DM0000 (allocated words: 2 words)

Numeral memory table entry #2: DM0002 (allocated words: 1 word)

Screen numbers to be created: #1 and #2

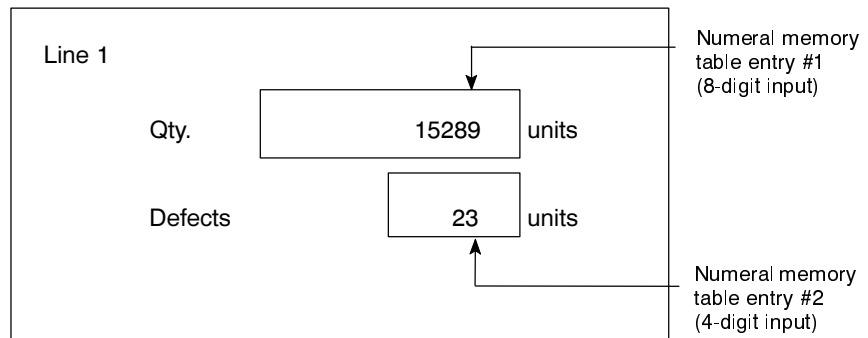

- PC ladder program

Create a PC ladder program as follows:

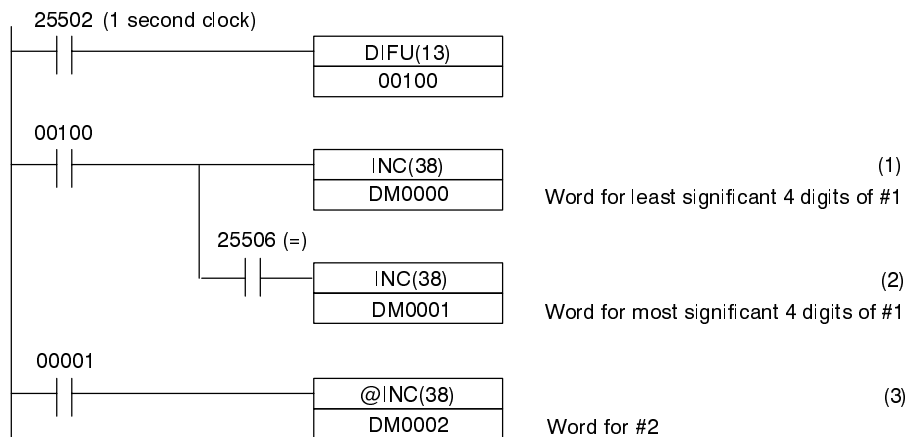

- Program operation

- (1) The contents of word DM0000 are incremented by 1 each second. The value displayed on the NT20S in numeral memory table entry #1 increases by 1 each second.
- (2) When the counter in (1) above causes an increase in the most significant digits, the contents of word DM0001 are incremented by 1 each second. The value displayed on the NT20S in numeral memory table entry #1 most significant digits increases by 1.

- (3) When bit 00001 turns ON, the contents of DM0002 are incremented by 1. The value displayed on the NT20S in numeral memory table entry #2 increases by 1.

5-2-3 Changing Displayed Numerical Values or Character Strings (Changing the Contents of Allocated Words ... Indirect Specification)

The following explains how to change numerical values or character strings displayed by the NT20S by changing the contents of the referenced allocated words using indirect specification. This method can only be used with Ver.5 of the direct connection function.

If using direct specification, see “Changing Displayed Numerical Values or Character Strings (Changing the Contents of Allocated Words ... Direct Specification)” (page 169).

Numerical values and character strings can also be changed by making a copy of the memory tables. Refer to “Copying the memory table” (page 174).

In indirect specification, a numeral memory table is specified to display a numerical value or character string. The numerical value stored in this numeral memory table (“39” in the figure below) is taken as the number of the memory table whose contents are to be displayed.

Either of the following two methods can be used to change the display when indirect specification is used:

- 1) Changing the memory table number for the memory table whose contents are to be displayed
(In the example in the figure below, this would mean changing the contents of numeral memory table 41.)
- 2) Changing the contents of the memory table used for display
(In the example in the figure below, this would mean changing the contents of character string memory table 39.)

Here, the method for changing the display using method 1) is explained. For details on method 2), see the explanations on direct specification (page 169) and copying memory tables (page 174).

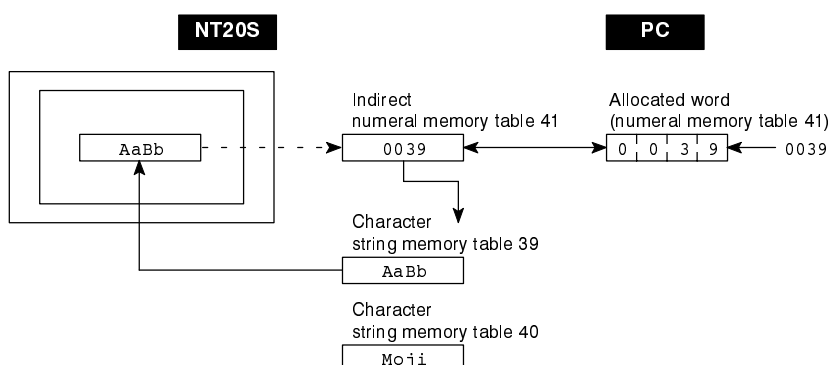

Reference: This method is convenient when switching the display at the same location, for example when monitoring a series of words, or when using unique codes to specify individual character strings, etc.

- Procedure**
1. Set the PC area for allocation of the numeral memory table to be referenced in indirect specification using the support tool.
 2. When using the support tool to create screen data, register on the screen the numeral memory table referenced in indirect specification. Specify the “indirect” option for the reference method.
In the case of a character string, use the “character display” function of the support tool to specify the numeral memory table.
In the case of a numerical value, use the “numeral display” function of the support tool to specify the numeral memory table.
 3. Use the “table edit” function of the support tool to write the actually displayed data to the memory table for display. If displaying a numerical value, use a numeral memory table and if displaying a character string use a character string memory table.
 4. Create a PC program to change the contents of the word allocated to the numeral memory table referenced in the indirect specification.

- Notes on writing memory table numbers

When writing the number of the memory table for display to the numeral memory table referenced in indirect specification, always specify it in BCD. Also, be sure to specify a number within the range of memory table numbers that actually exist (0 to 127).

If the contents of the numeral memory table for indirect specification are specified in hexadecimal format, or the number specified is outside the valid range for memory table numbers, the display is not updated.

- Notes on writing character strings

The points to note when displaying character strings are the same as those described for direct specification. See “Important points when writing a character string” (page 149).

Example Use of Indirect Specification

This example shows a case where the displayed character string is changed by incrementing the contents of the allocated word of the numeral memory table referenced in indirect specification.

- Settings with the support tool

Make the following settings with the support tool.

- Numeral memory table number 51: DM 0000 (number of registered words: 1)
- Character string memory table number 100: "NT610G" (6 digits)
- Character string memory table number 101: "NT610C" (6 digits)
- Character string memory table number 102: "NT20S" (6 digits)
- Character string memory table number 103: "NT600S" (6 digits)

Data registered for the screen: numeral memory table number 51.

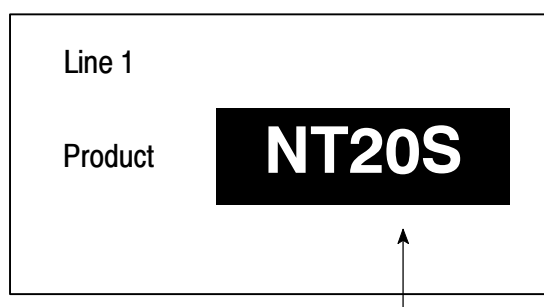

Numeral memory table number 51 specified in indirect specification of character string display

- PC program

Create the PC ladder program as follows:

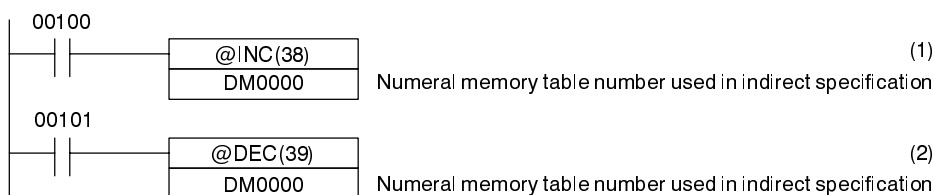

- Program operation

- (1) Each time contact 00100 comes ON, the display on the NT20S screen changes in accordance with one of the steps in the following sequence: "NT610G" → "NT610C" → "NT20S" → "NT600S".
- (2) Each time contact 00101 comes ON, the display on the NT20S screen makes changes in accordance with one of the steps in the following sequence: "NT600S" → "NT20S" → "NT610C" → "NT600S".

In this example, the contents of numeral memory table number 51 referenced in indirect specification are not checked. Make sure that the contents of numeral memory table number 51 stay within the range of 0100 to 0103 when the program is actually used.

5-2-4 Copying the Memory Table

The following describes the procedure to change displayed numerals or character strings by copying the contents of the memory table.

Numerals and character strings can be changed also by changing the contents of the allocated words. Refer to “Changing Displayed Numerals or Character Strings” (page 169) explained before.

To change the numerals or character strings displayed on the NT20S, copy the data between the numeral or character-string memory tables by using the “copy memory table setting” of the PT status control area.

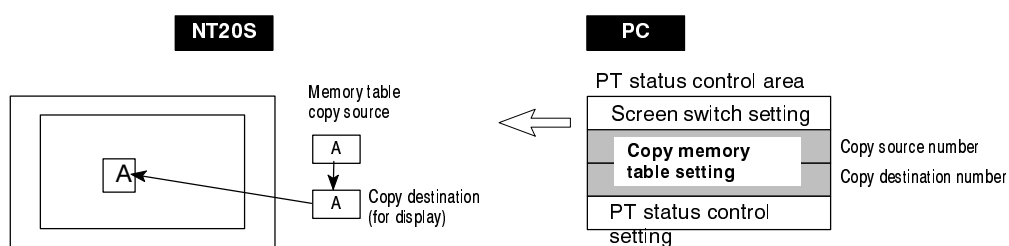

Write a memory table number etc. to the copy memory table setting area in the PT status control area in the PC memory. Data will be copied between the memory tables in the NT20S and the displayed value will change accordingly.

Reference: This procedure is convenient to switch predetermined values or character strings according to the situation. By preparing several units of contents, various contents can be displayed by switching them to suit the situation.

["Copy memory table setting" of the PT status control area]

	15	14	13	12	11	10	9	8	7	6	5	4	3	2	1	0	Bit
Word n+1	0			Copy source memory table # (3-digit BCD)) Copy memory table setting
Word n+2	Copy type			Copy destination memory table # (3-digit BCD)													

Copy type:

- 0: Copy between the character-string memory tables
- 1: Copy between the numeral memory tables

Copy source and destination memory table numbers: 000 to 127

- Available allocation words

The PT status control area can be allocated to the following PC areas:

Symbol	C Series PCs	Allocated	CVM1/CV Series PCs	Allocated
DM	Data Memory	○	Data Memory	○
CH	Internal/Special Relay	○	Internal/Special Relay	○
TIM	Timer	×	Timer	×
CNT	Counter	×	Counter	×
HR	Holding Relay	○	-	
AR	Auxiliary Relay	○	Auxiliary Relay	×
LR	Link Relay	○	-	

○: OK ×: NG

Since the special auxiliary relays of the CVM1/CV series PCs are allocated to the system, they cannot be used for purposes other than the system use.

The range of respective area varies with the type of PC. Refer to Appendix L PC Memory Map (page 278).

Procedure 1. Use the support tool to allocate the PT status control area (PC to PT) to the PC memory.

2. Register the memory tables for the numerals and character strings to be displayed when creating the screen data by using the support tool.

To display a character string, use “character display” and specify the character-string memory table by using the support tool.

To display numerals, use “numeral display” and specify the numeral memory table by using the support tool.

3. Set the copy source data to the memory table when creating the screen data by using the support tool.

Use “table edit”.

4. Create a PC program to write the copy type, copy destination memory table number, and copy source memory table number to the “copy memory table” setting word in the PT status control area.

- Order for writing to the PT status control area (PC to PT)

First write the “copy destination memory table number”, and then, write the “copy source memory table number” to the PT status control area (PC to PT).

The NT20S reads the area sometimes when the PC is writing the settings. If the “copy source memory table number” has been written first and is changed, unexpected memory table may possibly be changed.

- Allocated words that the NT20S reads

The NT20S reads the allocated words in the PC for the memory tables which need to be displayed. Even when a copy source memory table is allocated to a PC word, if its contents are never displayed it will be used only at initialization.

- Use of the “copy type”

Copy will not be executed when the “copy type” is other than “0” or “1”. The memory table copy is executed only when the contents of the area are changed. To repeat copying of the same copy source and same copy destination, write a value other than “0” or “1” for the copy type, and then, write a correct value again.

- Copying a numeral memory table

If the display method or the number of registered words include discrepancies, a numeral memory table may not be copied and displayed correctly.

Application Example of Copying of a Character-String Memory Table

This example gives a PC program to switch the character string display on the screen by using the memory table copy operation as the allocated bit is turned ON and OFF.

- Support tool settings

Allocate the memory as shown below by using the support tool.

PT status control area allocation: Word 0100

Contents registered to the screen: Character-string memory table #4

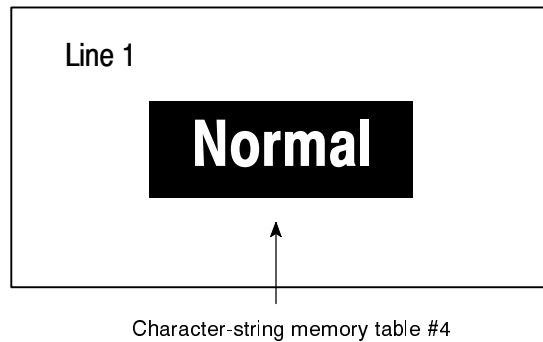

Character-string memory table settings

#	Contents	Number of Character Digits
4	Normal	6 digits
10	Error	6 digits
11	Normal	6 digits

- PC ladder program

Create a PC ladder program as follows:

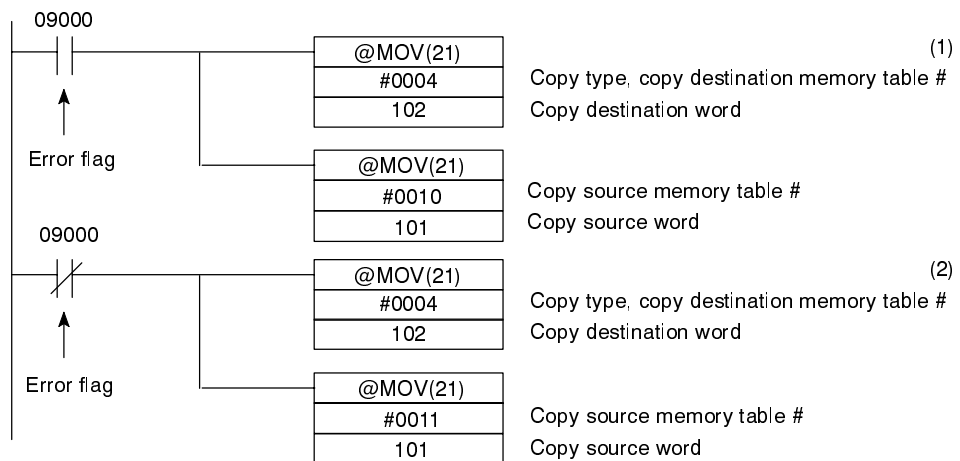

- Program operation

(1) When an error occurs (bit 09000 turns ON), the NT20S displays the message "Error".

(2) When the error is cleared (bit 09000 turns OFF), the NT20S display message reverts to "Normal".

5-2-5 Upgrading Bar Graphs (Changing the Contents of Allocated Words)

The following describes the procedure to upgrade the bar graph display on the NT20S by changing the contents of the allocated words.

To change the bar graph display on the NT20S, change the contents of the PC words to which the numeral memory tables have been allocated.

The bar graph display cannot use hexadecimal numbers. If hexadecimal numbers are set, the bar graph will not be displayed.

By writing a negative number (whose most significant digit is "F") to the allocated word of a graph set as "Sign display "No"", the graph display will become 0 % and the % display will show "*** %".

For the procedure to write numeral values to the allocated words of the numeral memory tables, refer to "Displaying the Contents of Allocated Words of Memory Tables" (page 167).

For the procedure to change the contents of the numeral memory table (PC words), refer to "Changing Displayed Numerals or Character Strings (Changing the Contents of Allocated Words)" (page 169).

- Available allocation words

The numeral memory tables can be allocated to the following PC areas:

Symbol	C Series PCs	Allocated	CVM1/CV Series PCs	Allocated
DM	Data Memory	○	Data Memory	○
CH	Internal/Special Relay	○	Internal/Special Relay	○
TIM	Timer	△	Timer	△
CNT	Counter	△	Counter	△
HR	Holding Relay	○	-	
AR	Auxiliary Relay	○	Auxiliary Relay	×
LR	Link Relay	○	-	

○: OK △: 1 word only ×: NG

Since the special auxiliary relays of the CVM1/CV series PCs are allocated to the system, they cannot be used for purposes other than the system use.

The range of respective area varies with the type of PC. Refer to Appendix L PC Memory Map (page 278).

5-3 Lamps, Touch Switches, Numeral Setting

5-3-1 Allocation Bits and Display of Lamps

Lamps are controlled by allocating them to the PC bits. Set the area and bit number.

- Available allocation bits

The lamps can be allocated to the following PC areas:

Symbol	C Series PCs	Allocated	CVM1/CV Series PCs	Allocated
DM	Data Memory	○	Data Memory	○
CH	Internal/Special Relay	○	Internal/Special Relay	○
TIM	Timer	×	Timer	×
CNT	Counter	×	Counter	×
HR	Holding Relay	○	-	
AR	Auxiliary Relay	○	Auxiliary Relay	×
LR	Link Relay	○	-	

○: OK ×: NG

Since the special auxiliary relays of the CVM1/CV series PCs are allocated to the system, they cannot be used for purposes other than the system use.

The range of respective area varies with the type of PC. Refer to Appendix L PC Memory Map (page 278).

To set the data memory (DM), specify the word number and then the bit number (00 to 15).

5-3-2 Turning ON (lit) and OFF (unlit) the Lamps (Changing the Contents of Allocated Bits)

The following describes the procedure to change the lamp display status on the NT20S by changing the contents of the allocated bits.

To change the lamp display status on the NT20S, turn ON and OFF the lamp control bit allocated in the PC.

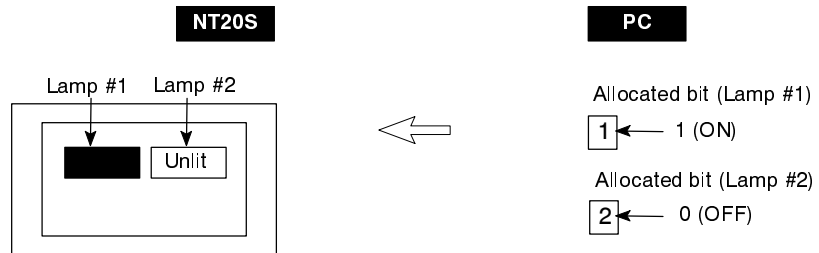

The lamp bit indicates the lamp status as follows:

0 (OFF): Unlit

1 (ON): Lit (reverse display) or flashing

- Procedure**
1. Use the support tool to set the PC memory area where the lamp bit is to be allocated to.
 2. Register the lamps to the screen when creating the screen data by using the support tool.
 3. Create a PC program to turn ON/OFF the lamp bit.

Use the support tool to set the lamp display attributes whether the lamp is lit or flashing when the lamp control bit is turned ON.

Application Example to Make the Lamp Light or Flash

This example gives a procedure to control the bits to move a robot arm and turning the lamps ON and OFF.

- Support tool settings

Allocate the memory as shown below by using the support tool.

Lamp #0: Word 000200 (output bit to raise robot arm), guide display message "UP"

Lamp #1: Word 000201 (output bit to lower robot arm), guide display message "DOWN"

Lamp #2: Word 000202 (output bit to rotate robot arm counterclockwise), guide display message "C/CLOCK"

Lamp #3: Word 000203 (output bit to rotate robot arm clockwise), guide display message "CLOCK"

Lamp #4: Word 000204 (output bit to clamp rotate robot arm), guide display message "CLAMP"

Lamp #5: Word 000205 (output bit to unclamp rotate robot arm), guide display message "UNCLAMP"

Contents registered to the screen: Lamp #0 to #5

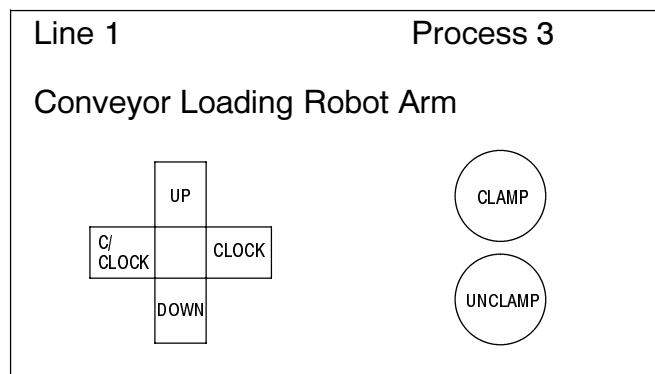

Raise:	Lamp#0
Lower:	Lamp#1
Counterclockwise:	Lamp#2
Clockwise:	Lamp#3
Clamp:	Lamp#4
Unclamp:	Lamp#5

- PC ladder program

No PC ladder program is required to control the NT20S. Only a program to control the robot arm movements is required.

- NT20S operation

When the ladder program to control the robot arm is executed, the lamps on the NT20S screen turn ON and OFF in synchronization with the robot arm movement.

For example, lamp #0 lights when the robot arm moves up and goes out when it stops moving up.

5-3-3 Allocated Bits, and Display, of Touch Switches

Method for PC Notification and NT20S Control

Two types of bit can be allocated to touch switches: notify bits - which serve to notify statuses to the PC - and control bits, lamp bit, which control the lighting (flashing) of the touch switches. (For other types of function, only lamp bits can be allocated.) When a touch switch is pressed the notify bit status changes and, when the lamp bit is ON, the touch switch lights (or flashes).

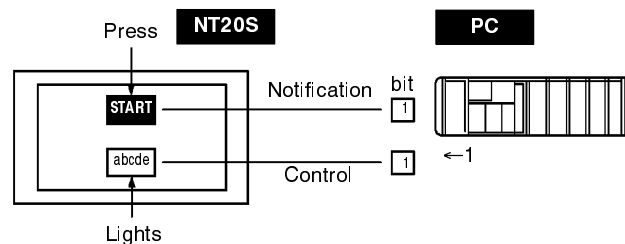

In order to notify the status of a touch switch to the PC, the touch switch must be allocated to a specified PC bit so that it can be managed. Designate the area and bit number.

To use touch switches for notification to the PC, the following settings must be made using the support tool: “touch switch” – “bit setting” – “notify bit”.

- Types of notification operation

When using Ver.5 of the direct connection function, the notification operation when the touch switch is pressed can be selected from the following four types (with Ver.4 direct connection, the type is fixed as “momentary”):

- Momentary

When the touch switch is pressed the bit comes ON; when it is released the bit goes OFF.

- Alternate

Each time the touch switch is pressed, the bit status changes from ON to OFF or OFF to ON.

- Set

When the touch switch is pressed, the bit comes ON and remains ON even if the switch is pressed again.

- Reset

When the touch switch is pressed, the bit goes OFF and remains OFF even if the switch is pressed again.

- Notes on the Notification Operation

The touch switch notification operations are as follows:

Type of Notification Operation	When Using Host Link or NT Link with DM Area	When Using C200H Direct Communication or NT Link with other than DM Area
Momentary	(1) Notification in word units (other bits go OFF)	(3) Notification in bit units
Alternate Set Reset	(2) Notification in word units (however, the word contents are read on display and notification is based on this reading)	(4) Notification in bit units

When using touch switch input notification, note the following points:

- In the case of (1), the other bits in the same word as the notification bit are turned OFF by the notification operation.
- In the case of (2), notification is executed on the basis of the contents of the word before display, which means that the other bits are not rewritten. However, if the word contents are changed at the PC side, they will be rewritten based on the contents before display.
- If the screen is switched while a momentary key is being pressed, the touch switch itself disappears, so the status "OFF" is notified. In the case of (1) this means that the other bits in the word will also be turned OFF.
- When using the host link, or NT link with the DM area, do not allocate momentary touch switches and other types of touch switch to the same word, since the notification operations are different.

In the case of (3) and (4), the notification operation has no influence on the other bits in the word.

- Possible bit allocations

Notify bits and lamp bits for touch switches can be allocated to the areas of the PC memory listed in the following table.

Symbol	C Series PCs	Allocated	CVM1/CV Series PCs	Allocated
DM	Data Memory	○	Data Memory	○
CH	Internal/Special Relay	○	Internal/Special Relay	○
TIM	Timer	×	Timer	×
CNT	Counter	×	Counter	×
HR	Holding Relay	○	-	
AR	Auxiliary Relay	○	Auxiliary Relay	×
LR	Link Relay	○	-	

○: OK ×: NG

Since all the CVM1/CV-series special auxiliary relays are allocated to the system, they cannot be used for applications not related to the system.

The range of each memory area differs according to the PC type. See "Appendix L PC Memory Map" (page 278 of the APPENDICES) for more details.

When making a data memory (DM) specification, specify the bit number (00 to 15) following the word number.

5-3-4 Lit (Flashing) and Unlit Touch Switch Statuses (Changing the Status of Allocated Bits)

This section describes how to change the statuses of allocated bits and thereby the statuses of the touch switches displayed by the NT20S.

The statuses of touch switches displayed by the NT20S are changed by switching the control bits allocated in the PC memory ON and OFF.

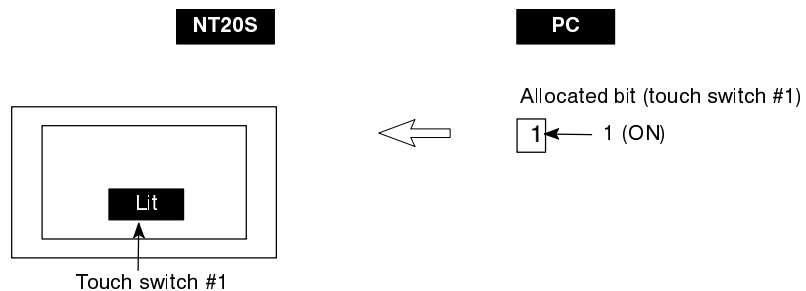

The status of the lamp bit reflects the touch switch status, as follows:

- 0 (OFF): Unlit
- 1 (ON): Lit (inverse display) or flashing

- Procedure**
1. Use the support tool to allocate the touch switch lamp bits to the PC memory.
 2. When creating the screen data using the support tool, register the touch switch for a screen.
 3. Create the PC program to switch the lamp bit of the touch switch ON and OFF. Set whether the lamp lights continuously or flashes when the bit comes ON by setting the touch switch display attribute with the support tool.

5-3-5 Notifying the Host that a Switch has been Pressed (Determining Touch Switch Status)

This section describes how the status of a touch switch (whether it has been pressed or not) is ascertained.

With the NT20S, when a touch switch is pressed, the notify bit allocated to that touch switch in the PC memory is automatically notified.

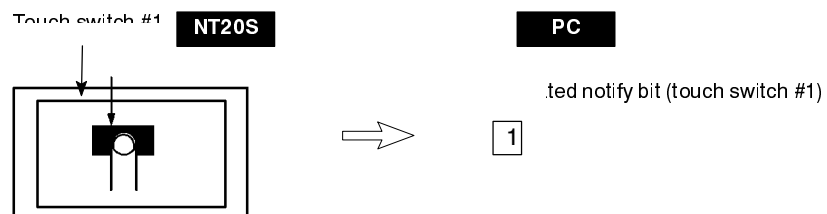

Depending on the set operation type, the status of the allocated bit for touch switch status notification will be controlled in one of the following ways (unless Ver.4 direct connection is used, in which case the setting is fixed as “momentary”):

- Momentary : 0 (OFF) ... Not pressed
:1 (ON) ... Pressed
- Alternate : The allocated bit is switched to 1 (ON) if currently 0, and to 0 (OFF) if currently 1.
- Set : The allocated notify bit is forcibly switched to 1 (ON).
- Reset : The allocated notify bit is forcibly switched to 0 (OFF).

In order to determine the status of a touch switch, the status of the touch switch notification bit allocated to it is determined.

The touch switch notify bits can be allocated to the following areas of the PC memory.

Symbol	C Series PCs	Allocated	CVM1/CV Series PCs	Allocated
DM	Data Memory	○	Data Memory	○
CH	Internal/Special Relay	○	Internal/Special Relay	○
TIM	Timer	×	Timer	×
CNT	Counter	×	Counter	×
HR	Holding Relay	○	–	
AR	Auxiliary Relay	○	Auxiliary Relay	×
LR	Link Relay	○	–	

○: OK ×: NG

Since all the CVM1/CV-series special auxiliary relays are allocated to the system, they cannot be used for applications not related to the system.

The range of each memory area differs according to the PC type. See “Appendix L PC Memory Map” (page 278 of the APPENDICES) for more details.

When making a data memory (DM) specification, specify the bit number (00 to 15) following the word number.

- Procedure**
1. Use the support tool to allocate the touch switch notify bits to the PC memory.
 2. When creating the screen data using the support tool, register the touch switch for a screen.
 3. Create a PC program to determine whether the touch switch notify bit is ON or OFF.

The touch switch notification operations are as follows:

Type of Notification Operation	When Using Host Link or NT Link with DM Area	When Using C200H Direct Communication or NT Link with other than DM Area
Momentary	(1) Notification in word units (other bits go OFF)	(3) Notification in bit units
Alternate Set Reset	(2) Notification in word units (however, the word contents are read on display and notification is based on this reading)	(4) Notification in bit units

When using touch switch input notification, note the following points:

- In the case of (1), the other bits in the same word as the notification bit are turned OFF by the notification operation.

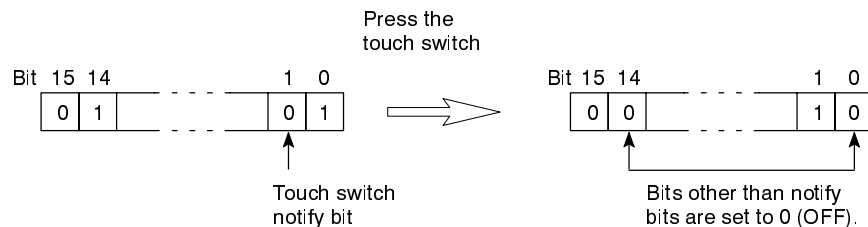

- In the case of (2), notification is executed on the basis of the contents of the word before display, which means that the other bits are not rewritten. However, if the word contents are changed at the PC side, they will be rewritten based on the contents before display.
- If the screen is switched while a momentary key is being pressed, the touch switch itself disappears, so the status "OFF" is notified. In the case of (1) this means that the other bits in the word will also be turned OFF.
- When using the host link, or NT link with the DM area, do not allocate momentary touch switches and other types of touch switch to the same word, since the notification operations are different.

In the case of (3) and (4), the notification operation has no influence on the other bits in the word.

Example of determination of touch switch status

This example uses the touch switches as normal switches (bits) in order to use the NT20S as an operating panel.

- Support Tool Settings

Make the following settings using the support tool.

Touch switch #10:

Function "Notify Bit"

Display attribute "Light"

Control bit CH05000 (Run flag) ... Guide message: "RUN"

Notify bit CH 06000

Touch switch #11:

Function "Notify Bit"

Display attribute "Light"

Control bit CH 05000 (Stop flag) ... Guide message: "STOP"

Notify bit CH 06001

Data registered for the screen: touch switch #10, touch switch #11

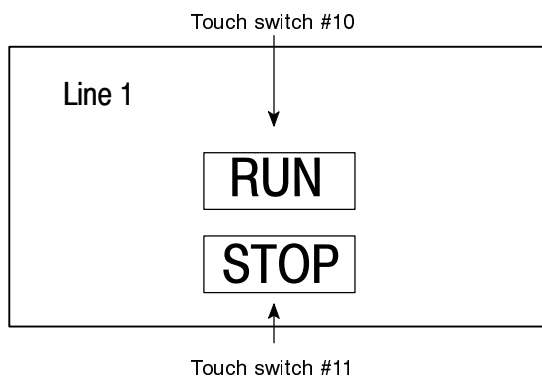

• PC program

Create the following ladder program.

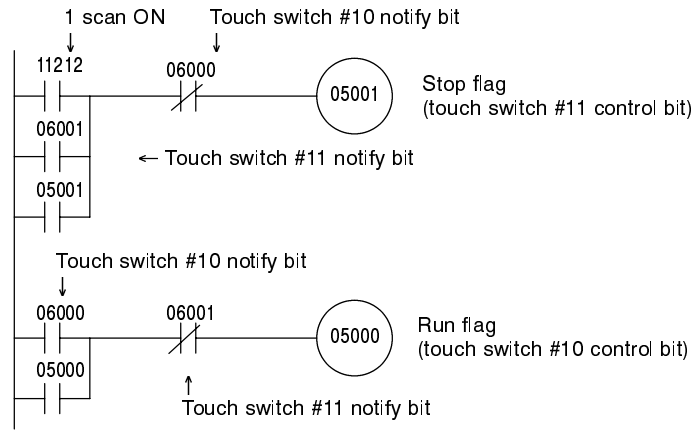

• Program operation

The operation when the program is executed is presented below.

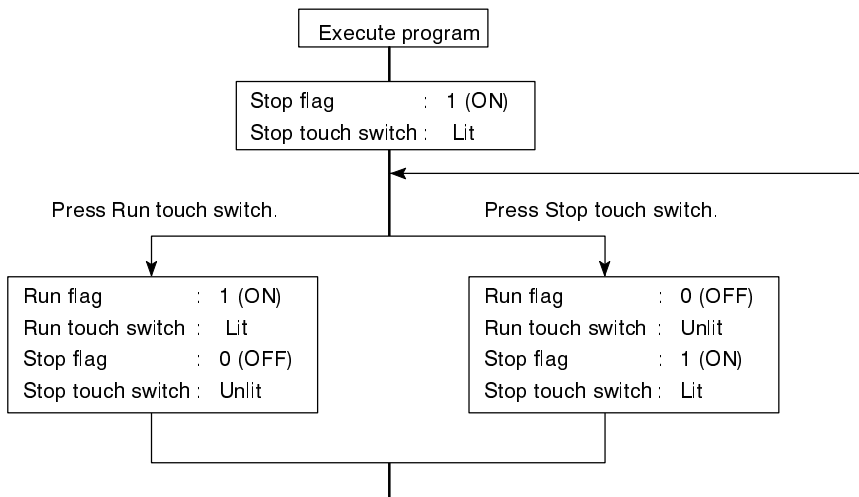

5-3-6 Notification of Numbers to the PC

The following describes how the numerical data input at the NT20S by using the numeral setting function is ascertained by the PC.

In order to determine when numerical data has been input at the NT20S, the numeral setting strobe flag in the PT status notify area is used. In order to determine the upgraded numeral memory table number, the “content upgrade memory table” in the PT status notify area is used.

When numerical data is input at the NT20S, this is automatically notified to the PT status notify area (PT → PC) allocated in the PC memory as follows.

- Notification of upgrade: PT status numeral setting strobe flag turned ON (1)
- Upgraded numeral table number: Stored in the “content upgrade memory table”

When the PC reads the “content upgrade memory table” at the leading edge of the numeral setting strobe flag, it determines the numeral memory table number in which the numerical data that was changed at the NT20S is stored.

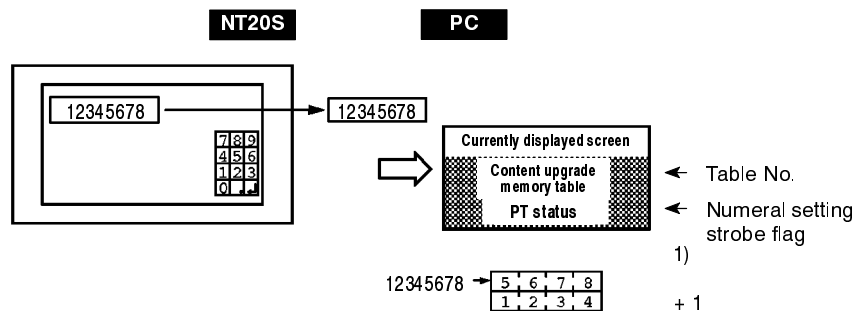

["Content upgrade memory table" in the PT status notify area and PT status]

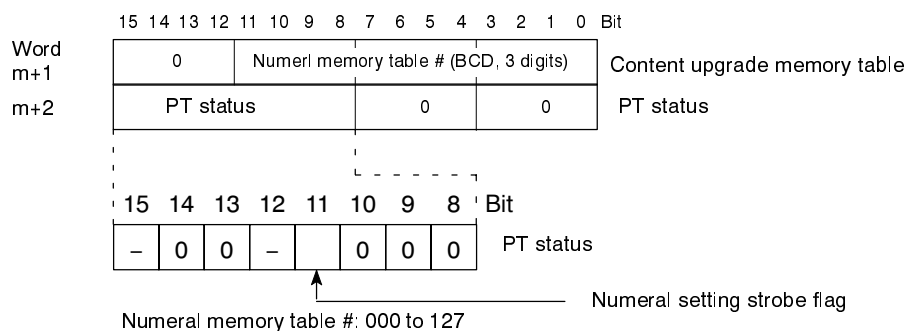

Data is written to the content upgrade memory table as three digits of BCD (binary coded decimal) data.

When the numeral setting strobe flag bit has been notified to the PC it returns to the OFF (0) status.

For details on the method for storing a number in the word allocated for the numeral memory table, see “Displaying the Contents of Allocated Words of Memory Tables” (page 167).

- Restrictions on allocating words

The PT status notify area can be allocated to the PC memory areas listed in the following table.

Symbol	C Series PCs	Allocated	CVM1/CV Series PCs	Allocated
DM	Data Memory	○	Data Memory	○
CH	Internal/Special Relay	○	Internal/Special Relay	○
TIM	Timer	×	Timer	×
CNT	Counter	×	Counter	×
HR	Holding Relay	○	–	
AR	Auxiliary Relay	○	Auxiliary Relay	×
LR	Link Relay	○	–	

○: OK ×: NG

Since all the CVM1/CV-series special auxiliary relays are allocated to the system, they cannot be used for applications not related to the system.

The range of each memory area differs according to the PC type. See “Appendix L PC Memory Map” (page 278 of the APPENDICES) for more details.

- Procedure**
1. Use the support tool to allocate the PT status notify area (PT → PC) to the PC memory.
 2. Using the support tool, create a numeral setting screen and allocate the numeral memory table to the PC memory.
 3. Create a PC program for reading the “content upgrade memory table” in the PT status notify area when the numeral setting strobe flag in the PT status notify area comes ON (1).
 4. Read the allocated word for the numeral memory table number read in step 3.

Example of reading a numeral memory table into which a numerical value has been input

This example shows the reading of the numeral memory table number after a value has been changed by inputting numerical data at the NT20S.

- Setting at the support tool

Make the following settings using the support tool.

Allocated word for the PT status notify area : CH0110

Numeral memory table entry No.3: DM 0005 (saved word: One)

Numeral memory table entry No.4: DM 0006 (saved word: One)

Data registered for the screens:

Numeral setting 1 ... Reference table "numeral memory table #3"

Numeral setting 2 ... Reference table "numeral memory table #4"

Numeral memory table entry number 3 (4-digit input)

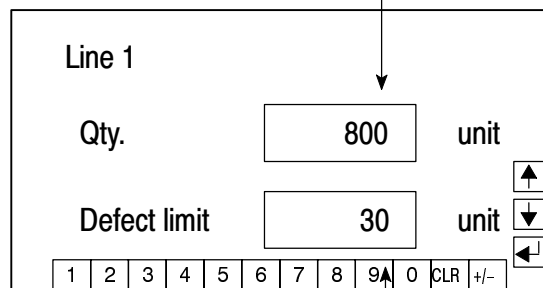

Numeral memory table entry number 4 (4-digit input)

- PC program

Create the following PC ladder program.

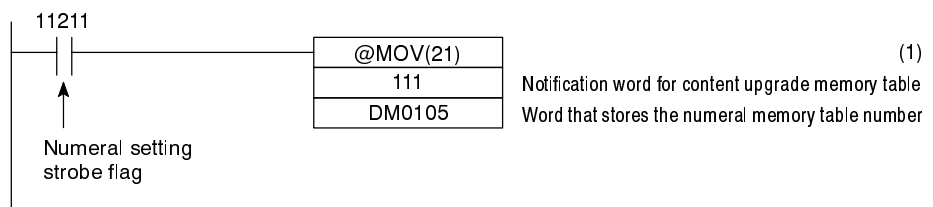

- Program operation

(1) When the numeral setting strobe flag (bit 11211) comes ON (1), the contents of CH-0111 (the word where the content upgrade memory table is located) are transferred to DM 0105. The number of the numeral memory table that contains the upgraded data is stored in DM 0105 (in this case it is 0003 or 0004).

If the numeral memory table is allocated to a PC word, the value input to it can be read easily by referring to the allocated word.

In this case, the contents of numeral memory table #3 are stored in DM 0005 and the contents of numeral table #4 are stored in DM 0006.

5-4 NT20S Status Control

The statuses of the NT20S can be controlled from the PC by writing control data to the "PT status control bits" of the PT status control area allocated in the PC memory.

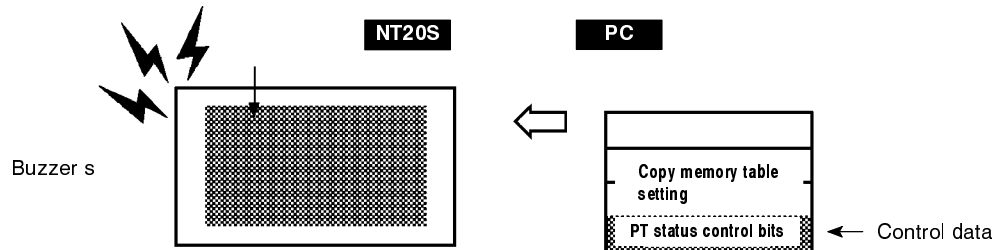

5-4-1 Controllable NT20S Functions

[“PT status control bits” of the PT status control area]

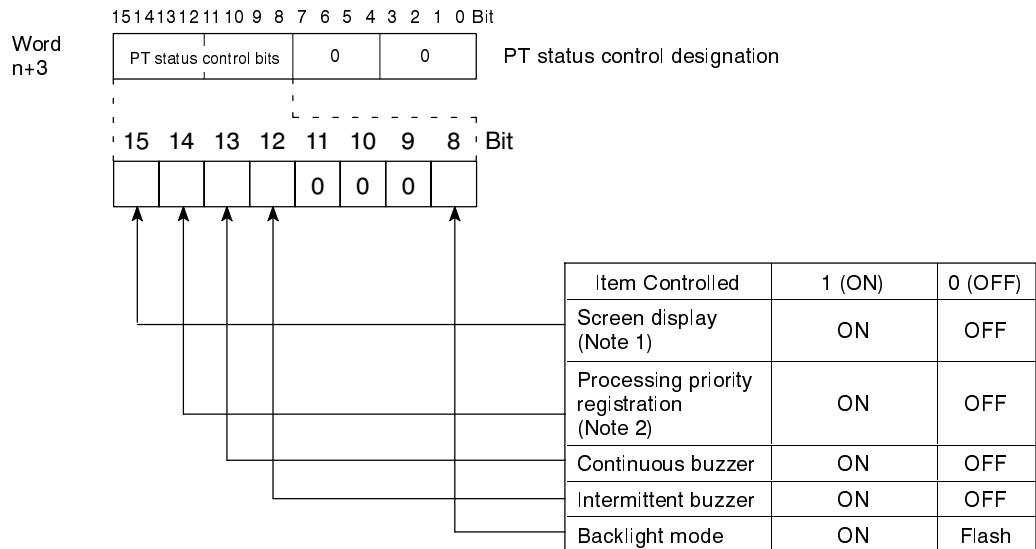

Note 1: The backlighting is on when the screen display bit is set to ON and off when the screen display bit is set to OFF.
 Note 2: Priority registration is only valid when NT link (1:N) is set.

The PC status control bits remain unchanged if the NT20S status is changed with the screen attributes or memory switches, which means that the statuses of the PT status control bits do not match the actual status of the NT20S. For example, the buzzer may sound even though the setting for continuous buzzer bit 13 is "OFF".

In this kind of case, control the NT20S by using the PT status control bits.

- Screen display (bit 15)

The screen display bit is used to display and clear the screen to prevent “burn-in” on the CRT. Set bit 15 to 0 (OFF) to clear the screen. The backlight will also go OFF at the same time.

When the screen has been cleared, the last displayed screen can be redisplayed either by turning Bit 15 ON, or by pressing a touch switch. The backlight will also light at the same time.

Note that if the screen is OFF by the backlight OFF or EL screen OFF function with Bit 15 ON (1), turn Bit 15 OFF (0) once and then turn it back ON (1) to redisplay the screen.

Reference: Instead of turning Bit 15 ON, a screen can be displayed by specifying its screen number. For details on screen switching, see “Switching the Screen Display” (page 157).

- Priority registration for processing (NT link 1:N connections only) (bit 14)

It is possible to register one of the multiple PTs connected by the 1:N NT link method to have processing priority. The PT for which bit 14 is set ON (1) is given priority over the other PTs and has a higher response speed for display, touch switches, etc.

When bit 14 is turned OFF (0), this registration is canceled and the normal response speed is reinstated. If priority registration is set for more than one PT, the one for which the registration was made last will have priority.

By monitoring C200HX/HG/HE words, the unit number of the PT for which priority registration has been set can be confirmed. For details on the monitoring operation at the PC side, refer to the manual for the PC used.

[Connection to RS-232C port of C200HX/HG/HE]

Channel	Bit	Function
CI0265CH (standard port) CI0284CH (port A) (*) CI0285CH (port B) (*)	0	Unit No.0 Communication in progress flag, ON when connected
	1	Unit No.1 Communication in progress flag, ON when connected
	2	Unit No.2 Communication in progress flag, ON when connected
	3	Unit No.3 Communication in progress flag, ON when connected
	4	Unit No.4 Communication in progress flag, ON when connected
	5	Unit No.5 Communication in progress flag, ON when connected
	6	Unit No.6 Communication in progress flag, ON when connected
	7	Unit No.7 Communication in progress flag, ON when connected
	8	Unit No.0 Priority registration lamp, ON when registered
	9	Unit No.1 Priority registration lamp, ON when registered
	10	Unit No.2 Priority registration lamp, ON when registered
	11	Unit No.3 Priority registration lamp, ON when registered
	12	Unit No.4 Priority registration lamp, ON when registered
	13	Unit No.5 Priority registration lamp, ON when registered
	14	Unit No.6 Priority registration lamp, ON when registered
15	Unit No.7 Priority registration lamp, ON when registered	

(*) This is the port of the communication port.

- Continuous buzzer (bit 13) and intermittent buzzer (bit 12)

In the case of both buzzers, when the respective bit is ON the buzzer sounds and when it is OFF the buzzer does not sound.

The “continuous buzzer” sounds continuously without interruption.

The “intermittent buzzer” sounds for 0.5 seconds at 0.5 second intervals.

If both Bit 13 and Bit 12 are turned ON simultaneously, Bit 13 takes priority and the continuous buzzer is selected.

Another way to stop a buzzer sounding is to use a touch switch to which the buzzer stop attribute function is allocated.

Whether or not the buzzer actually sounds also depends on the setting of the “buzzer” memory switch of the NT20S. For details on this setting, see “Using the Buzzer” (page 92).

Besides using PT status control bit operations, the buzzer status can also be controlled by the screen attributes. The screen attributes are set by using the support tool. The functions that can be set using the screen attributes are the following:

Buzzer attribute: Set whether or not the buzzer will sound when the screen is displayed and, if it sounds, the type of buzzer.

- Backlight mode (bit 8)

If bit 8 is turned ON when the screen is displayed (bit 15 = ON), the screen is made to flash using the backlight. When bit 8 is turned OFF, normal display is resumed.

When the screen is not displayed (bit 15 = OFF), the backlight mode is invalid.

It is possible to use NT20S switch settings to make the backlight go off automatically after a set time during which there have been no operations.

Besides using PT status control bit operations, the backlight status can also be controlled by the screen attributes. The screen attributes are set by using the support tool. The functions that can be set using the screen attributes are the following:

Backlight: Set whether the backlight will be continuously or intermittently lit when the screen is displayed.

5-4-2 How to Control NT20S Functions

This section describes how to control the functions of the NT20S.

- Restrictions on allocating words

The PT status control area (PC → PT) can be allocated to the PC memory areas listed in the following table.

Symbol	C Series PCs	Allocated	CVM1/CV Series PCs	Allocated
DM	Data Memory	○	Data Memory	○
CH	Internal/Special Relay	○	Internal/Special Relay	○
TIM	Timer	×	Timer	×
CNT	Counter	×	Counter	×
HR	Holding Relay	○	–	
AR	Auxiliary Relay	○	Auxiliary Relay	×
LR	Link Relay	○	–	

○: OK ×: NG

Since all the CVM1/CV-series special auxiliary relays are allocated to the system, they cannot be used for applications not related to the system.

The range of each memory area differs according to the PC type. See “Appendix L PC Memory Map” (page 278 of the APPENDIX L) for more details.

- Procedure**
1. Use the support tool to set the area at the PC used for allocation of the PT status control area (PC → PT).
 2. Write a PC program for writing the control data into the “PT status control bit” of the PT status control area.

- Timing for control of the PT status control bit

The PT status control bit is not read when the NT20S is started up. It is read, and control executed, only when the contents of the PT status control bit are read for the first time after the NT20S is started up.

Since NT20S status control is executed when the bit corresponding to the PT status control bit changes, in order to perform the same control again the corresponding bit must be specified again.

Example of Use of PT Status Control Bit

The example below explains how operation with the PT status control bit can be used to use the NT20S like a warning lamp.

- Setting with the support tool

Make the following setting with the support tool.

Allocated word for PT status control area: CH 0100

- PC program

Create the PC ladder program as follows.

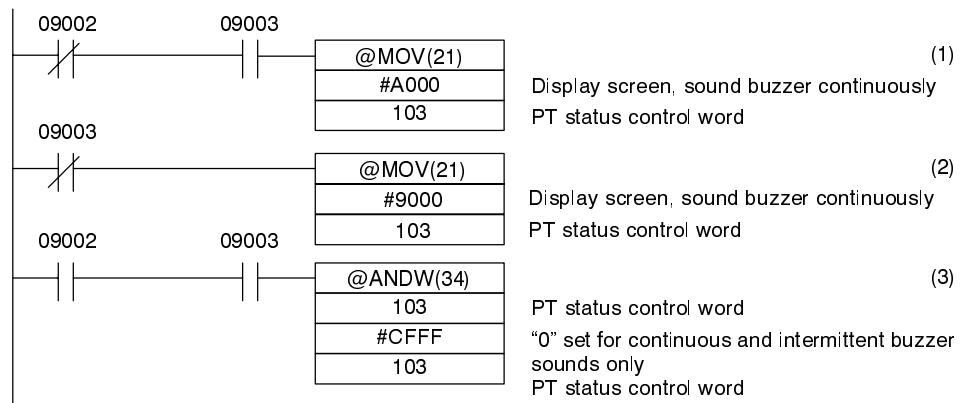

- Program operation

- (1) The PT status control bits are set as shown below when bit 09002 turns OFF. This command block is not executed when bit 09003 is ON.

Screen display (bit 15)	1 (ON)
Continuous buzzer (bit 13)	1 (ON)

The NT20S continuous buzzer sounds.

- (2) The PT status control bits are set as shown below when bit 09003 turns OFF.

Screen display (bit 15)	1 (ON)
Intermittent buzzer (bit 12)	1 (ON)

The NT20S intermittent buzzer sounds.

- (3) The PT status control bits are set as shown below when both bits 09002 and 09003 turn ON.

Continuous buzzer (bit 13)	0 (OFF)
Intermittent buzzer (bit 12)	0 (OFF)

The NT20S buzzer stops.

5-5 Notification of the Operating Status to the PC (Determining the NT20S Operating Status)

The status (operating statuses, etc.) of the NT20S can be determined from the PC by reading the “PT status” word in the PT status notify area allocated in the PC memory.

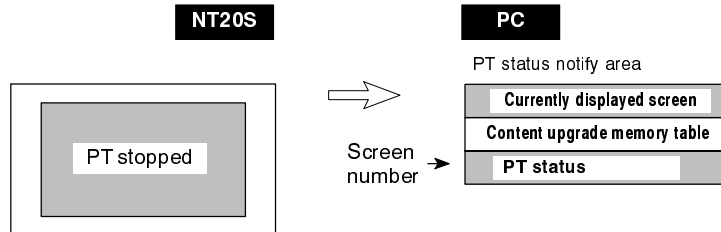

5-5-1 Ascertainable NT20S Statures (Notified Operating Statures)

[“PT status notification bits” of the PT status notify area]

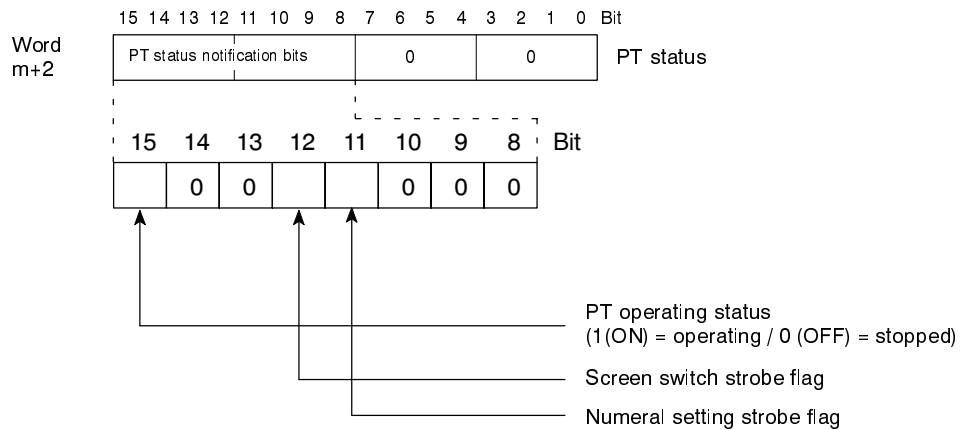

⚠ Caution: Make the settings so that the PT control area and PT status notify area do not overlap.

- PT operating status (bit 15)

When the NT20S is in the RUN mode this bit is set to ON (1). In other modes and while the system menu is displayed it is OFF (0). When this bit is OFF allocated bits and words cannot be read or written to.

During the run mode, ON (1) is periodically written into this bit. In order to check whether the NT20S is operating normally or not, write OFF (0) to this bit: if it is ON (1) 30 seconds later the NT20S is running, and if it is OFF (0), the NT20S is stopped.

⚠ Caution: To ensure system safety, be sure to periodically read the PT operating status bit from the host in order to ensure that the PT is always operating normally.

- Screen switch strobe flag (bit 12)

When the screen displayed on the NT20S is switched by a designation from the PC or by the standalone function, the screen switch strobe flag comes ON (1). On notification to the PC, it returns to the OFF (0) status.

For details on how the screen switch strobe flag is used, see “Notifying the Display Screen to the PC” (page 160).

- Numeral setting strobe flag (bit 11)

When numerical data is input to a numeral memory table using the NT20S numeral setting function, the numeral setting strobe flag comes ON (1). On notification to the PC, it returns to the OFF (0) status.

For details on how the numeral setting strobe flag is used, see “Notification of Numbers to the PC” (page 188).

5-5-2 Reading the NT20S Operating Statuses

This section explains how to determine the status of the NT20S, and ascertain its operating status.

To ascertain the operating status of the NT20S, “PT status” is used.

The NT20S automatically notifies information such as the operating status to the PT status word of the PT status notify area (PT → PC) allocated to the PC memory as shown below.

Notification of operation mode:	PT operating status
Notification of screen switching:	Screen switch strobe flag
Notification of numerical data upgrade:	Numeral setting strobe flag

- Restrictions on allocating words

The PT status notify area (PT → PC) can be allocated to the PC memory areas listed in the following table.

Symbol	C Series PCs	Allocated	CVM1/CV Series PCs	Allocated
DM	Data Memory	○	Data Memory	○
CH	Internal/Special Relay	○	Internal/Special Relay	○
TIM	Timer	×	Timer	×
CNT	Counter	×	Counter	×
HR	Holding Relay	○	–	
AR	Auxiliary Relay	○	Auxiliary Relay	×
LR	Link Relay	○	–	

○: OK ×: NG

Since all the CVM1/CV-series special auxiliary relays are allocated to the system, they cannot be used for applications not related to the system.

The range of each memory area differs according to the PC type. See “Appendix L PC Memory Map” (page 278 of the APPENDIX L) for more details.

- Procedure**
1. Use the support tool to allocate the PT status notify area (PT → PC) to the PC memory.
 2. Write a PC program to read the “PT status” word of the PT status notify area and check each bit status.

- Timing of PT status notify bit notification

The contents of the PT status notify area (PT → PC) are written to the PC whenever the status of the NT20S changes during operation.

Example of PT Status Notify Bit Application

In the example below, the status of the NT20S is checked by PT status notify bit notification.

- Settings with the support tool

Make the following setting with the support tool.

Allocated word for PT status notify area: CH0110

- PC program

Create the following PC ladder program.

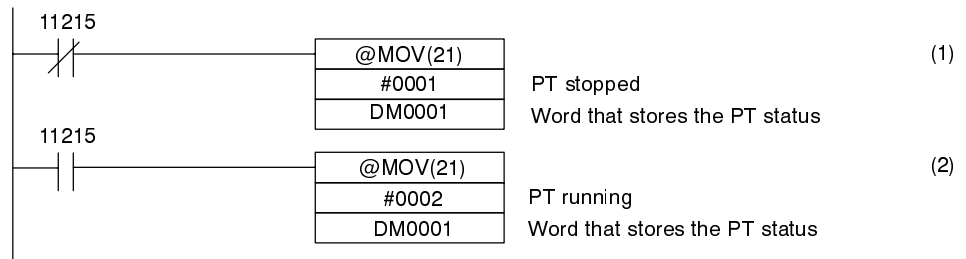

- Program operation

- (1) When the PT operating status (contact 11215) is OFF (0), "1" (PT stopped) is stored in DM0001.
- (2) When the PT operating status (contact 11215) is ON (1), "2" (PT running) is stored in DM0001.

SECTION 6

Using the RS-232C

This section explains how to carry out communication via the RS-232C interface used with an NT20S-ST128, focusing on the commands.

	Table of Commands	200
6-1	RS-232C Communications	201
	6-1-1 Communication Procedure	201
	6-1-2 Precautions	203
6-2	Screen Display	204
6-3	Memory Tables	205
6-4	Lamps, Touch Switches, Numeral Setting	208
	6-4-1 Notification and Control of Touch Switches	208
	6-4-2 Notification of numeral setting input and touch switch status	212
6-5	Controlling the NT20S Status	214
6-6	Terminal Commands	216
6-7	Key to Programs	222
	6-7-1 Use of Programs	222
	EXAMPLE PROGRAM	223

Table of Commands

Operating Commands

Type	Command	Name	Page
Screen control	[ESC] 0	Display Specified Screen	204
	[ESC] X	Request Screen Number	204
Memory table operation	[ESC] B	Write Character-string Memory Table	205
	[ESC] C	4-digit Write Numeral Memory Table	206
	[ESC] D	8-digit Write Numeral Memory Table	206
	[ESC] /	Copy Memory Table	207
Lamp and Touch Switch Display	[ESC] K	Lamp and Touch Switch Display (Bit Specification)	210
	[ESC] Q	Lamp and Touch Switch Display (Number Specification)	210
	[ESC] R	Lamp and Touch Switch Display Status Enquiry	211
Touch Switch and Function Key Input	[ESC] U	Touch Switch Disable	214
	[ESC] V	Touch Switch Enable	214
System Control	[ESC] P	Screen Display Control	215
	[ESC] T	Buzzer Control	215
	[ESC] W	System Menu Display Permission	215
Notification	[ESC] Y	Screen Number Response	205
	[ESC] E	4-digit Number Input Notify	212
	[ESC] F	8-digit Number Input Notify	212
	[ESC] S	Lamp and Touch Switch Display Status Response	211
	[ESC] J	Touch Switch Bit Output (from NT20S to Host)	213
	[ESC] H	Touch Switch Number Output (from NT20S to Host)	213

Terminal Commands

Type	Command	Name	Page
Character Size	[ESC] &	Clear Screen	216
	[ESC])	Character Specify Size	217
	[ESC] *	Specify Character Enlargement	217
Character Display Attributes	[ESC] !	Normal Display	218
	[ESC] "	Set Inverse Display	218
	[ESC] #	End Inverse Display	218
	[ESC] \$	Set Flashing Display	219
	[ESC] %	End Flashing Display	219
Character String Display	[ESC] +	Set Cursor Position	220
	[ESC] 4	Specify Displayed Characters	220
Graphic Display	[ESC] 7	Draw Polyline	221
	[ESC] 8	Draw Circle	221

6-1 RS-232C Communications

This section describes the communication procedure when using an NT20S-ST128 (RS-232C), and program flow using examples in BASIC.

6-1-1 Communication Procedure

The Host and NT20S communicate according to the following procedure.

- 1, 2, 3...**
1. The RS-232C circuit must be opened (i.e., communication enabled) before communication can start.
 2. Commands are used to control the PT and to receive notification from the NT20S.
 3. Close the RS-232C circuit again after communication is complete.

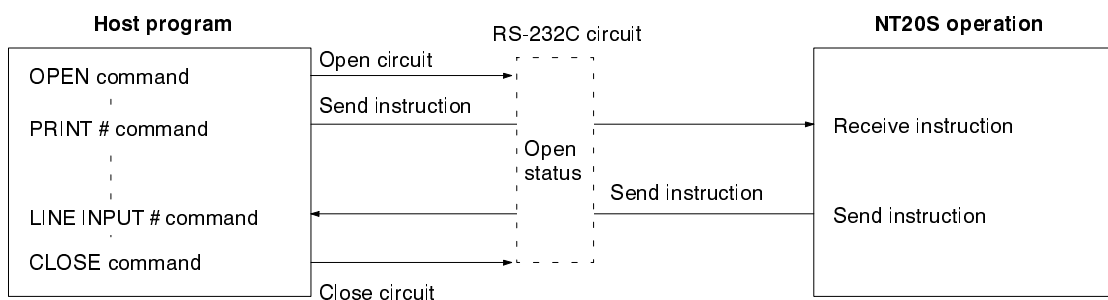

After a circuit has been opened, it can be used until it is closed again.

OPEN

Opens the RS-232C circuit. The Host communication conditions are also set. Refer to (3-5-4) *Setting RS-232C Communication Conditions*.

PRINT

Sends an instruction via the RS-232C circuit to the NT20S.

LINE INPUT

Receives a command from the NT20S. [LINE INPUT] is used when receiving input delimited by commas (,) or double quotation marks (").

CLOSE

Closes the RS-232C circuit.

Refer to the Host's BASIC Manual for more details about the commands.

Operation by Operating Commands

The operating commands display monitored data from the production line and messages to the factory workers. They are also used for NT20S control and management.

The communication flow between the Host and NT20S differs according to the following three cases:

Message from Host to NT20S



Enquiry from Host to NT20S

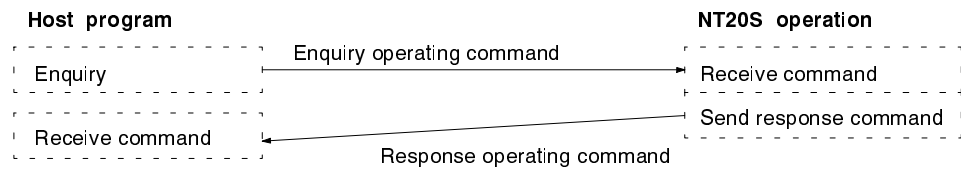

Notification of Operation at NT20S to the Host

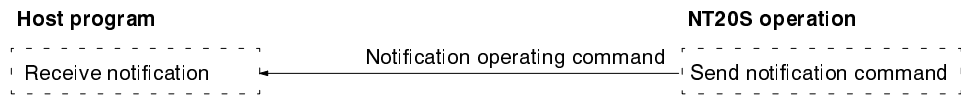

Operation by Terminal Commands

The terminal commands allow the NT20S to be used as a terminal of the Host to display text and graphics independently of the screens stored in the NT20S.

The Host sends a command and the NT20S processes the message. The NT20S does not send back a response to the Host.



6-1-2 Precautions

Some important points to consider when using commands are listed below.

Command Length

If a mistake during command specification results in a command being too long, the correct length of the command is executed and the remainder is ignored.

A timeout error results if a mistake during command specification results in a command being too short.

Interval Between Transmitted Commands

As a small number of bytes is transmitted by the Host, the interval between transmissions should not exceed 5 seconds if a command is divided up for transmission. A timeout error occurs if the interval between transmissions exceeds 5 seconds.

When commands are sent too frequently, a buffer overflow error may occur if the NT20S cannot keep up with the command processing.

In order to prevent buffer overflow, use flow control.

Controlling PT Status with Operating Commands

Control of the NT20S status by the operating commands is restricted by the NT20S memory switch settings as listed below.

Operating command	Restriction from memory switch setting
Buzzer control command [ESC] T	Effective when "buzzer turned on"

Coordinate Specification with the Terminal Commands

The entire command is ignored if any point specified at coordinates X, Y with the Terminal commands lies outside the screen.

Error display

If the "automatic reset after communication" memory switch of the NT20S is set to ON, no message is displayed when a communication error occurs. However, time-out errors are displayed.

6-2 Screen Display

This section describes the commands for switching the screen display of the NT20S and the commands for ascertaining the screen number of the screen currently displayed by the NT20S.

The displayed screen can be also switched by pressing a touch switch for which the screen number of the screen to be displayed has been registered. For details on this method, refer to "Screen Switching Function" on page 138.

To change the NT20S screen, use the Display Specified Screen Command. To ascertain the screen number of the currently displayed screen, use the Request Screen Number Command. When this command is executed, the NT20S returns the Screen Number Response Command.

When the currently displayed NT20S screen is changed by pressing a touch switch to which a screen number has been allocated, the Screen Number Response Command is automatically sent from the NT20S.

Display Specified Screen

Format

[ESC]	0	m ₁	m ₂	m ₃	m ₄
1B	30	* *	* *	* *	* *

m₁m₂m₃m₄: Number of displayed screen (4-digit hexadecimal)
 0000: No display
 0001 to 01FA_H: Screen #1 to #500

Description

The specified screen is displayed on the NT20S when a screen number is sent from the Host with this command.

Request Screen Number

Format

[ESC]	x
1B	58

Description

Enquires what number screen is displayed on the NT20S. The NT20S returns the number of the displayed screen using the Screen Number Response Command (refer to 6-2 *Screen Number Response*).

Screen Number Response

Format

[ESC]	Y	m ₁ m ₂ m ₃			[CR]
1B	59	* *	* *	* *	OD

m₁m₂ m₃: Number of displayed screen (4-digit hexadecimal)
000 to 1FA_H (0 to 500)

Description

- The NT20S returns this command to report the currently displayed screen number to the Host in response to the Request Screen Number Command (refer to 6-2 *Request Screen Number*) sent from the Host.
- The new screen number is report to the Host with this command after the displayed screen is switch with the Stand-alone functions (screen switch function).

6-3 Memory Tables

This section explains the commands used for memory table operations.

To change the contents of a character string memory table, use the Write Character-string Memory Table Command.

To change the contents of a numeral memory table, use a Write Numeral Memory Table Command.

Note that different commands are used to write 4-digit and 8-digit numerical values.

Values can be copied from one memory table to another of the same type by using the Copy Memory Table Command.

- Reference:**
- When the contents of an NT20S numeral memory table are changed by numeral setting input, a Number Input Notify Command is automatically sent from the NT20S (refer to page 212)
 - By creating a bar graph screen and arranging for it to refer to a particular numeral memory table, the display contents of the bar graph can be updated by changing the contents of the numeral table.

Write Character-string Memory Table

Format

[ESC]	B	n ₁	n ₂	d ₁	d ₂	c ₁	c ₂	c ₃	---	c _n
1B	42	* *	* *	* *	* *	* *	* *	* *	{ }	* *

n₁n₂: Character string length as a number of normal characters (2-digit hexadecimal) 01 to 20_H (1 to 32)

d₁d₂: Character-string memory table address of write destination (2-digit hexadecimal) 00 to 7F_H (0 to 127)

c₁c₂c₃ to c_n: Character-string data

Description

Writes the character-string data to the character-string memory table.
The character-string data can contain a mixture of normal alphanumeric characters and marks. When determining the character string length, count each mark as two normal characters.

**Caution:**

If the actual character string is longer than the specified character string length, the specified number of characters is written and the remainder are discarded.
A timeout error message is displayed if the actual character string is shorter than the specified character string length.

4-digit Write Numeral Memory Table**Format**

[ESC]	C	d ₁	d ₂	d ₃	n ₁	n ₂	n ₃	n ₄
1B	43	* *	* *	* *	* *	* *	* *	* *

d₁d₂d₃: Numeral memory table address of write destination (3-digit hexadecimal) 000 to 07F_H (0 to 127)

n₁n₂n₃n₄: Number data (4-digit BCD or 4-digit hexadecimal)

Description

- Writes 4-digit number data (decimal or hexadecimal) to the specified numeral memory table.
- If a 4-digit number data is written while an 8-digit numeral is displayed, the lower 4 digits are updated.

**Caution:**

This command cannot be used to write negative numbers. Use the 8-digit Write Command (refer to 6-3 8-digit Write Numeral Memory Table).

8-digit Write Numeral Memory Table**Format**

[ESC]	D	d ₁	d ₂	d ₃	n ₁	n ₂	n ₃	n ₄	n ₅
1B	44	* *	* *	* *	* *	* *	* *	* *	* *
		n ₆	n ₇	n ₈					
		* *	* *	* *					

d₁d₂d₃: Numeral memory table address of write destination (3-digit hexadecimal) 000 to 07F_H (0 to 127)

n₁n₂n₃n₄n₅n₆n₇n₈: Number data (8-digit BCD or 8-digit hexadecimal)

Description

- Writes the 8-digit number data (decimal or hexadecimal) to the specified numeral memory table
- To write a negative numeral (decimal), specify "F(46_H)" for "n₁" (in this case, a 7-digit numeral is written.)

Copy Memory Table

Format

[ESC]	/	m_1	s_1	s_2	s_3	d_1	d_2	d_3
1B	2F	* *	* *	* *	* *	* *	* *	* *

m_1 : Type of memory table
 0 (30_H): Character-string memory table
 1 (31_H): Numeral memory table

$s_1s_2s_3$: Copy source memory table address
 000 to 127 (3-digit BCD)

$d_1d_2d_3$: Copy destination memory table address
 000 to 127 (3-digit BCD)

Description

Copies the contents of the copy source memory table to the copy destination memory table. The memory table contents are copied to a memory table of the same type: character-string memory table to character-string memory table or numeral memory table to numeral memory table.

6-4 Lamps, Touch Switches, Numeral Setting

This section describes the commands for operating the lamps, touch switches.

In order to change the display status (lit (flashing) or unlit) of a lamp or touch switch, use the Lamp and Touch Switch Display Commands. There are two such commands, one for bit specification and the other for number specification.

The Lamp and Touch Switch Display Status Enquiry Command is used to ascertain the status of a lamp or touch switch. When this command is executed the NT20S returns the Lamp/Touch Switch Display Status Response Command.

Reference: When the status of an NT20S touch switch is changed - for example by pressing it - the Touch Switch Number Output Command is sent to the host. When a numerical value is input by pressing a touch switch to which a numeral setting function has been allocated, a Number Input Notify Command is sent to the host.

6-4-1 Notification and Control of Touch Switches

If a touch switch is pressed, the corresponding touch switch number or bit information is sent to the Host. Conversely, to turn ON a touch switch or cause it to flash, the touch switch # or bit information is sent from the Host.

The type of data relating to the touch switch notification is specified with the "bit input attribute" in the screen attributes when creating the screen data with the support tool. It is not permissible to use both notification and control by a touch switch number and notification and control by bit information on the same screen.

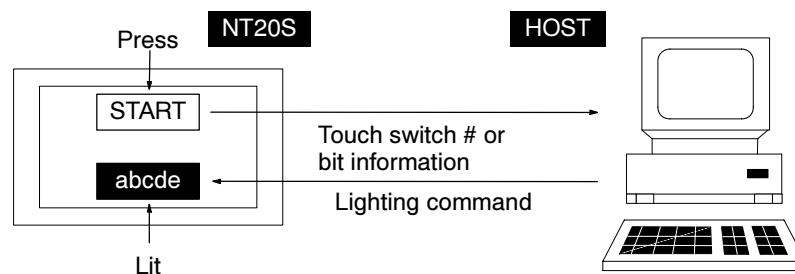

- Bit touch switch method (bit input permitted setting)

If a touch switch is pressed, bit information is sent in accordance with the position of the touch switch. It can be used as a normal bit input switch at the PC side. When this method is used, if more than one touch switch is pressed at the same time, the information of all the pressed touch switches (0 to 63) is reported to the Host.

- Touch switch # method (bit input not-permitted setting)

If the touch switch status is changed, the touch switch number set when the touch switch is created is sent as a 8-digit hexadecimal number.

Cautions when bit input is permitted

If the touch switches are set in the following positions using the support tool while the setting is "bit input permitted", the following operations will occur due to the configuration of the touch switches.

Take this into consideration when setting touch switch areas.

Example 1:

Touch switches are set at positions A, B, C, and D using the minimum switch setting unit.

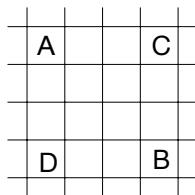

- If switches A, B, and C are turned ON at the same time, switch D is also set ON.
- Similarly, if switches A, B, and D are turned ON at the same time, switch C is also set ON.

Example 2:

Touch switch areas E, F, and G are set.

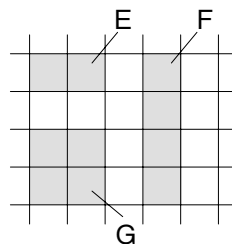

- If switches E and F are turned ON at the same time, switch G is also set ON.

Touch switch notification/control and attributes

Inverse and normal display states can be set as attributes of touch switches by using the support tool. There are slight differences in the operation when a touch switch is pressed depending on whether bit input is permitted or not permitted.

Bit input not permitted: Touch switch notification by number

The touch switch is lit for 0.2 seconds when pressed and then returns to the unlit status.

Bit input permitted: Touch switch notification by bit information

The touch switch is lit while pressed and returns to the unlit status when released.

When a touch switch which is currently lit or flashing is pressed, it is continuously lit while pressed and returns to its original state when released.

Simultaneous pressing of multiple touch switches

Two or more touch switches can be simultaneously pressed if their statuses are notified by bit information or if they use different host notification methods. However, two or more switches cannot be simultaneously pressed if their statuses are notified to the host by their numbers.

Lamp and Touch Switch Display (Bit Specification)

Format

[ESC]	K	m0 ₁	m0 ₂	m1 ₁	m1 ₂	m2 ₁	m2 ₂	m3 ₁	m3 ₂	[CR]
1B	4B	* *	* *	* *	* *	* *	* *	* *	* *	0D

m0 to m3: Specification of lamps and touch switches (2-digit hexadecimal)

The relationship between the lamp and touch switch number and an expression of m0 to m3 in bits is given in the following table.

Parameter \ Bit	mx ₁				mx ₂			
	7	6	5	4	3	2	1	0
m0	07	06	05	04	03	02	01	00
m1	15	14	13	12	11	10	09	08
m2	23	22	21	20	19	18	17	16
m3	31	30	29	28	27	26	25	24

mx₁: Higher 4 bits of mx (x: 0 to 3)

mx₂: Lower 4 bits of mx

Bit ON: The lamp or touch switch is turned on (or caused to flash).

Bit OFF: The lamp or touch switch is turned off.

Example

To turn on lamps and touch switches with the numbers 1, 5, 6, 7, and 26

m0₁m0₂m1₁m1₂m2₁m2₂m3₁m3₂=E200004

Description

- Changes the display status of the lamps or touch switches.
- Whether the lamp or touch switch which corresponds to the specified bit is turned on or flashes is determined by the setting made using the support tool.
- This command can be used only when the setting for the "LMP Bit Control" memory switch is "Enable".

Lamp and Touch Switch Display (Number Specification)

Format

[ESC]	Q	m ₁	n ₁	n ₂
1B	51	* *	* *	* *

m₁: Display status

0 (30_H): Not lit (normal display)

1 (31_H): Lit

2 (32_H): Flashing inverse

3 (33_H): All not lit

n₁n₂: Lamp or touch switch # (2-digit hexadecimal)

000 to FF_H (0 to 255)

Description Changes the lamp or touch switch lighting status. Specify the display status as 3 (all not lit) to turn off all the lamps and touch switches. In this case, specify the lamp or touch switch number to any number in the permitted range.

Caution: The display attributes set with the Support Tool determine if lamps #0 to #31 light continuously or flash. The display status set with this command is ignored.

Lamp and Touch Switch Display Status Enquiry

Format

[ESC]	R	n ₁ n ₂	
1B	52	* *	* *

n₁n₂: Lamp or touch switch # (2-digit hexadecimal)
000 to FF_H (0 to 255)

Description Enquires the status of a lamp or touch switch specified by its address. The NT20S returns the Lamp and Touch Switch Display Status Response Command (refer to 6-4-1 Lamp and Touch Switch Display Status Response) to report the display status.

Lamp and Touch Switch Display Status Response

Format

[ESC]	S	m ₁	n ₁ n ₂	
1B	53	* *	* *	* *

m₁: Display status
0 (30_H): Not lit (normal display)
1 (31_H): Lit
2 (32_H): Flashing inverse

n₁n₂: Lamp or touch switch # (2-digit hexadecimal)
00 to FF_H (0 to 255)

Description The NT20S returns this command to report the lamp or touch switch number display status to the Host in response to the Lamp and Touch Switch Display Status Enquiry Command (refer to 6-4-1 Lamp and Touch Switch Display Status Enquiry) sent from the Host.

Note: Lamps 0 to 31 are reported as being lit when in the “flashing inverse” status.

6-4-2 Notification of numeral setting input and touch switch status

The following describes the commands for notifying the host when numeral setting is performed (i.e., when the contents of a numeral memory table are changed by pressing a touch switch) or when a touch switch is pressed, when operating the NT20S.

When a numerical value is input by numeral setting, the NT20S sends a Number Input Notify Command to the host. The command sent differs depending on whether a 4-digit or 8-digit number is input.

When a touch switch is pressed, the NT20S sends a Touch Switch Number Output Command or Touch Switch Bit Output Command to the host. The command sent depends on the set screen attributes.

4-digit Number Input Notify

Format

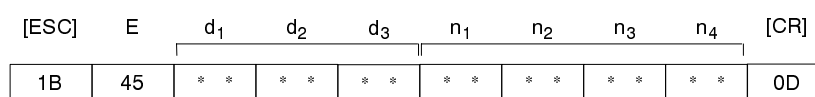

d₁d₂d₃: Numeral memory table address to which number was input (3-digit hexadecimal) 000 to 07F_H (0 to 127)

n₁n₂n₃n₄: Input number data (4-digit BCD)

Description

A number with 4 transferred digits set with the NT20S number setting function is reported to the Host with this command.

⚠ Caution: This command cannot be used for negative numbers. Always set "8" as the number of transferred digits when negative numbers may be input.

8-digit Number Input Notify

Format

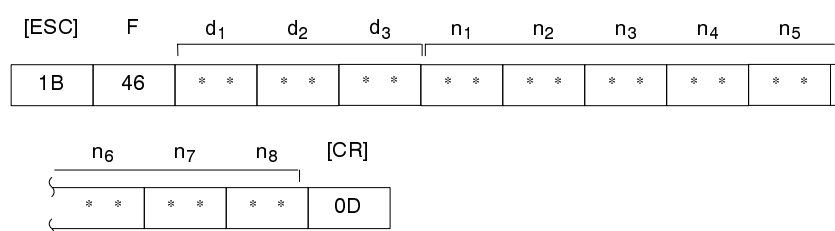

d₁d₂d₃: Numeral memory table address to which number was input (3-digit hexadecimal) 000 to 07F_H (0 to 127)

n₁n₂n₃n₄n₅n₆n₇n₈: Input number data (8-digit BCD)

Description

A number with 8 transferred digits set with the PT number setting function is reported to the Host with this command.

When a negative number is written, n1 becomes "F" (46_H) and the number comprises 7 digits.

Touch Switch Number Output (from NT20S to Host)**Format**

[ESC]	H	m ₁ m ₂		[CR]
1B	48	* *	* *	0D

m₁m₂: Address of the pressed touch # (2-digit hexadecimal)
00 to E2_H (0 to 226)

Description

If a touch switch is pressed while the screen for which the “Bit In = Off” attribute is set is displayed, the address of the pressed touch switch is reported to the Host.

Reference: If more than one touch switch is pressed at the same time, only the address of the touch switch which was pressed first is reported to the Host.

Notification of numeral setting is not executed in the case of touch switches which have been allocated as ten keys.

Touch Switch Bit Output (from NT20S to Host)**Format**

[ESC]	J	s ₀ ₁	s ₀ ₂	s ₁ ₁	s ₁ ₂	s ₂ ₁	s ₂ ₂	s ₃ ₁	s ₃ ₂	[CR]
1B	4A	* *	* *	* *	* *	* *	* *	* *	* *	0D

s₀,...s₃: Status of the touch switch (2-digit hexadecimal value for each switch)
The relationship between the touch switch number and an expression of s₀ to s₃ in bits is given in the following table.

Bit Parameter	sX ₁				sX ₂			
	7	6	5	4	3	2	1	0
s ₀	07	06	05	04	03	02	01	00
s ₁	15	14	13	12	11	10	09	08
s ₂	23	22	21	20	19	18	17	16
s ₃	31	30	29	28	27	26	25	24

sx₁: Higher 4 bits of s_x (x: 0 to 3)

sx₂: Lower 4 bits of s_x

Bit ON: The touch switch is on.

Bit OFF: The touch switch is off.

Example

Touch switches at addresses 0, 3, 21, and 27 are ON

s₀₁s₀₂s₁₁s₁₂s₂₁s₂₂s₃₁s₃₂=09002008

Description

- If the touch switch status is changed while the screen for which the “Bit Input, Touch Switch” attribute is set is displayed, the status of the corresponding bit is reported to the Host.

- This report is made each time a touch switch is turned ON or OFF.

6-5 Controlling the NT20S Status

This section describes the actual methods used for controlling the NT20S status.

The Screen Display Control Command is used to operate the back light of the NT20S (i.e., switch it on and off).

The Buzzer Control Command is used to control the buzzer status of the NT20S. To inhibit the display of the system menu or cancel this inhibition, use the Mode Switch Enable Command.

Touch switch data input or host notification can be inhibited, or this inhibition canceled, by using the Touch Switch and Function Key Disable Command or Touch Switch and Function Key Enable Command respectively.

Touch Switch Disable

Format

[ESC] U 2

1B	55	32
----	----	----

Description

Disables touch switch and function key input and notification to the Host.

Reference: Use the Touch Switch Enable Command (refer to *6-5 Touch Switch Enable*) to use a disabled touch switch again. Disabled touch switches are also enabled when the NT20S power is turned off.

Touch Switch Enable

Format

[ESC] V 2

1B	56	32
----	----	----

Description

Enables input and notification to the Host of a disabled touch switch or function key.

Reference: Disabled touch switches are also enabled when the NT20S power is turned off.

Screen Display Control

Format

[ESC] P m₁

1B	50	* *
----	----	-----

m₁: Display on or off
 0 (30_H): on
 1 (31_H): off

Description

Turns off the backlighting.

- Reference:**
- The screen is redisplayed if a touch switch is pressed.
 - When a Display Specified Screen Command (page 204) is sent, the specified screen is displayed.

Buzzer Control

Format

[ESC] T m₁

1B	54	* *
----	----	-----

m₁: Buzzer status
 0 (30_H): Buzzer off
 1 (31_H): Continuous buzzer
 2 (32_H): Short intermittent buzzer

Description

Controls the NT20S buzzer.

- Reference:** The buzzer turned on with this command can be stopped with a Buzzer control command, press the “buzzer stop” touch switch on the screen, or by displaying a screen with no buzzer attributes.

System Menu Display Permission

Format

[ESC] W m₁

1B	57	* *
----	----	-----

m₁: System menu display permission/inhibition
 0 (30_H): Display permitted
 1 (31_H): Display inhibited

Description

System menu is displayed when “display permitted” is set, and from the system menu, selection of transmit mode or maintenance mode is possible. If “display inhibited” is set, the system menu is not displayed.

Turning off the power or resetting operation validates the settings made with the DIP switch (SW2-3) on the NT20S.

6-6 Terminal Commands

This section describes the terminal commands used to display character strings or graphics in accordance with instructions from the host, independently of the screens registered in the NT20S.

Terminal commands designate screen attributes such as inversion, flashing, cursor position and size of characters before the characters are displayed.

Once screen attributes are set, they remain effective for screen displays until they are cancelled or other attributes are set.

In addition, continuous lines and circles can be drawn.

Clear Screen

Format

[ESC] &

1B	26
----	----

Description

Clears all text and graphics on the NT20S screen.

Reference: Even if this command is used to clear a screen, the NT20S still displays the preceding screens.

After the display of number, text, lamps or touch switches is upgraded, only the upgraded parts are re-displayed.

Character Specify Size

Format

[ESC]) m₁

1B	29	* *
----	----	-----

m₁: Character size

0 (30_H): Normal size, 16 x 8 dots (H x W)

1 (31_H): 1/2 size, 8 x 8 dots (H x W)

Description

Specifies if 1-byte alphanumeric characters sent subsequently are displayed as normal characters or 1/2-size characters.

Reference: The character string is specified with the Specify Displayed Characters Command (refer to *6-6 Specify Displayed Characters*). Both normal characters and 1/2-size characters are enlarged as specified by the Specify Character Enlargement Command (refer to *6-6 Specify Character Enlargement* below).

The character size specified with this command remains valid until the screen display is switched or another character size is specified with the command. The default character size is normal characters.

Specify Character Enlargement

Format

[ESC] * m₁

1B	2A	* *
----	----	-----

m₁: Character enlargement

0 (30_H): No enlargement

1 (31_H): Enlarge height x 2

2 (32_H): Enlarge width x 2

3 (33_H): 2 x 2 enlargement

4 (34_H): 3 x 3 times enlargement

5 (35_H): 4 x 4 times enlargement

Description

All text and marks sent after this command are displayed in the specified size.

Reference: The character string is specified with the Specify Displayed Characters Command (refer to *6-6 Specify Displayed Characters*).

The enlargement specified with this command remains valid until the screen display is switched or another enlargement is specified with the command. The default enlargement is no enlargement.

Normal Display

Format

[ESC] !

1B	21
----	----

Description

Cancels all display attribute settings (inverse, flashing, flashing inverse) for characters and marks so that all characters are displayed as “normal” characters (not inverse or flashing).

Set Inverse Display

Format

[ESC] ”

1B	22
----	----

Description

Sets the display attribute to inverse so that all characters and marks sent subsequently are highlighted. Other attributes remain unchanged.

Reference: The Set Inverse Display Command is cancelled by the End Inverse Display Command or the Normal Display Command.

The setting with this command remains valid until the screen display is switched or another display attribute setting is made. The default display attributes are set to a normal display when a screen is initially displayed.

Use this command with the Set Flashing Display Command (refer 6-6 *Set Flashing Display*) to produce a flashing inverse display.

End Inverse Display

Format

[ESC] #

1B	23
----	----

Description

Clears the inverse display attribute so that all characters and marks sent subsequently are not highlighted. Other attributes remain unchanged.

Reference: The inverse display attribute is set with the Set Inverse Display Command.

The setting with this command remains valid until the screen display is switched or another display attribute setting is made. The default display attributes are set to a normal display when a screen is initially displayed.

Set Flashing Display

Format

[ESC] \$

1B	24
----	----

Description

Sets the display attribute to flashing so that all characters and marks sent subsequently are displayed flashing. Other attributes remain unchanged.

Reference: The Set Flashing Display Command is cancelled by the End Flashing Display Command or the Normal Display Command (refer to *6-6 Normal Display* and *6-6 End Flashing Display*).

The setting with this command remains valid until the screen display is switched or another display attribute setting is made. The default display attributes are set to a normal display when a screen is initially displayed.

Use this command with the Set Inverse Display Command (refer to *6-6 Set Inverse Display*) to produce a flashing inverse display.

End Flashing Display

Format

[ESC] %

1B	25
----	----

Description

Clears the flashing display attribute so that all characters and marks sent subsequently are not flashing. Other attributes remain unchanged.

Reference: The flashing display attribute is set with the Set Flashing Display Command. The setting with this command remains valid until the screen display is switched or another display attribute setting is made. The default display attributes are set to a normal display when a screen is initially displayed.

Set Cursor Position

Format

[ESC]	+	x ₁	x ₂	x ₃	y ₁	y ₂	y ₃
1B	2B	* *	* *	* *	* *	* *	* *

x₁x₂x₃: X coordinate (3-digit BCD)
000 to 255

y₁y₂y₃: Y coordinate (3-digit BCD)
000 to 127

Description

Before displaying a character string with the Terminal commands, use this command to set the bottom-left point of the first character to be displayed.

Reference: The cursor position set with this command is also the bottom-left point of the first character displayed if the displayed characters are enlarged.

Specify Displayed Characters

Format

[ESC]	4	n ₁	n ₂	c ₁	c ₂	c ₃	---	c _n
1B	34	* *	* *	* *	* *	* *	{ }	* *

n₁n₂: Character string length as a number of normal characters (2-digit hexadecimal)
01 to 20H (1 to 32)

c₁c₂c₃ to c_n: Character-string to display

Description

- The character string is displayed from the cursor position.
- The character-string data can contain a mixture of normal (alphanumeric) characters and marks. Refer to *Appendix M Special Characters* for details.
- The character string is displayed according to the enlargement and display attributes set with commands.

Reference: The character string continues on the next line if it cannot fit into a single line.

Set the position where the character string is displayed with the Set Cursor Position Command (refer to *6-6 Set Cursor Position*).

Draw Polyline**Format**

[ESC]	7	m ₁		m ₂		x0 ₁			x0 ₂			x0 ₃			y0 ₁			y0 ₂			y0 ₃			---		
1B	37	*	*	*	*	*	*	*	*	*	*	*	*	*	*	*	*	*	*	*	*	*	*	*	*	}
		xn ₁			xn ₂			xn ₃			yn ₁			yn ₂			yn ₃			}						
		*	*	*	*	*	*	*	*	*	*	*	*	*	*	*	*	*	*	*	*	*	*	*	*	}

m₁, m₂: Number of lines to draw (2-digit hexadecimal)
01 to 28_H (1 to 40)

x0₁x0₂x0₃ to xn₁xn₂xn₃: X coordinates of line end points (3-digit BCD)
000 to 255

y0₁y0₂y0₃ to yn₁yn₂yn₃: Y coordinates of line end points (3-digit BCD)
000 to 127

Description

Draws the specified number of lines between the specified points.

Draw Circle**Format**

[ESC]	8	x ₁			x ₂			x ₃			y ₁			y ₂			y ₃			r ₁			r ₂			r ₃							
1B	38	*	*	*	*	*	*	*	*	*	*	*	*	*	*	*	*	*	*	*	*	*	*	*	*	*	*	*	*	*	*	*	*

x₁x₂x₃: X coordinate of circle center (3-digit BCD)
000 to 255

y₁y₂y₃: Y coordinate of circle center (3-digit BCD)
000 to 127

r₁r₂r₃: circle radius in dots (3-digit BCD)
001 to 063

Description

Draws a circle of the specified radius around the circle center point.

6-7 Key to Programs

The following programs include all the commands that can be used with the NT20S.

6-7-1 Use of Programs

The sample program appears as follows on the screen.

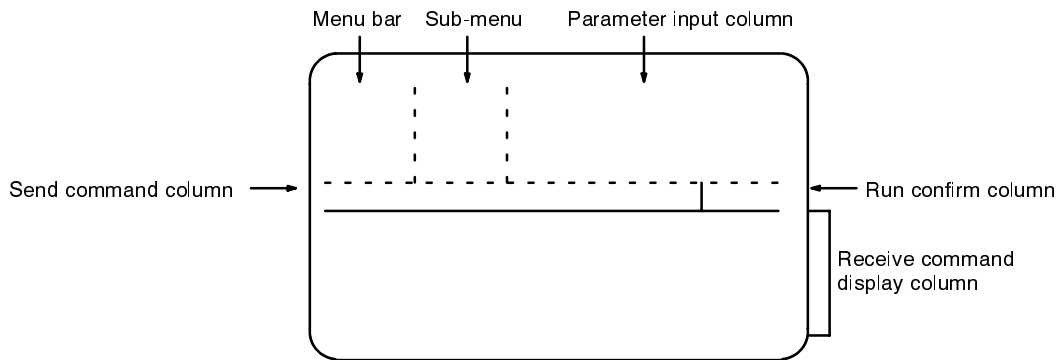

Use the program as shown below.

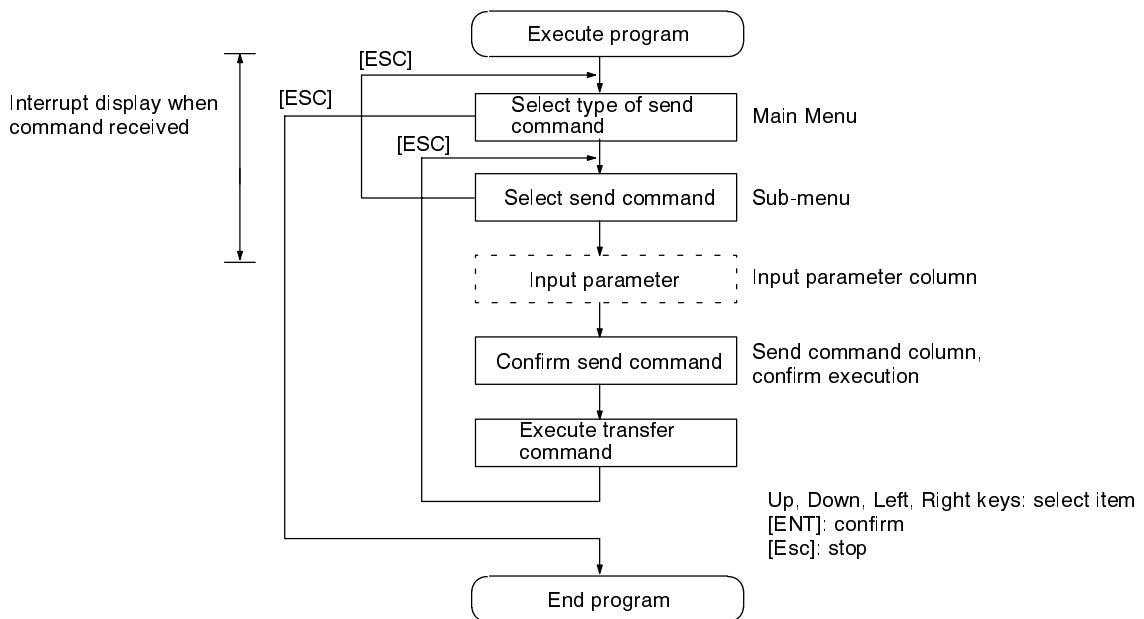

1. **This sample program is written in N88BASIC (86) (NEC) for a PC-9801 computer. Modify this program for use with any other computer language or computer such as an IBM PC/AT or compatible.**
2. **The interval between parameter input and command transmission is a hold interval for interrupt processing of the received command. If an interrupt is permitted between the interval of parameter input and a command is received, all subsequent receive interrupts are displaced. If this occurs, send an enquiry command to read all the accumulated receive data.**
3. **When a parameter is input, no check is made that the parameter is in the permitted range. Make sure that parameters are input within the permitted range.**

EXAMPLE PROGRAM

```

1000 ' *****
1010 ' * OPERATION COMMAND EXAMPLE PROGRAM (NT20S-ST128) *
1020 ' *****
1030 ' ..... Draw screen frame
1040 SECT=9
1050 DIM CMND$(SECT,10,1),CMND(SECT),TS.B(31)
1060 SCREEN 3:CLS 3:CONSOLE 15,10,0,0
1070 LINE (0,176)-(639,176),7,,&HF0F0
1080 LINE (159,0)-(159,176),7,,&HF0F0
1090 LINE (300,0)-(300,176),7,,&HF0F0
1100 LINE (0, 16)-(159, 16),7,,&HF0F0
1110 LINE (0, 96)-(159, 96),7,,&HF0F0
1120 LINE (0,112)-(159,112),7,,&HF0F0
1130 LINE (520,176)-(520,224),7,,&HF0F0
1140 LINE (0,223)-(639,224),7,B
1150 COLOR 0:LOCATE 2,0:PRINT "OPERATING COMMANDS"
1160 COLOR 0:LOCATE 2,6:PRINT "TERMINAL COMMANDS"
1170 CMND(0)=SECT ' ..... Set display character strings
1180 FOR I=1 TO SECT
1190   READ CMND$(0,I,0)
1200 NEXT I
1210 FOR I=1 TO SECT
1220   READ CMND(I)
1230   FOR J=1 TO CMND(I)
1240     READ CMND$(I,J,0),CMND$(I,J,1)
1250     IF CMND$(I,J,1) = "#####" THEN CMND$(I,J,1) = "[ESC]" + CHR$(&H22)
1260   NEXT J
1270 NEXT I
1280 '
1290 RY=15
1300 ON COM(1) GOSUB *RECV ' ..... Set receive interrupt routine
1310 OPEN "COM1:E81NN" AS #1 ' ..... Open communication port
1320 ' NT20S_SETTING OF ST128
1330 ' DATA BIT LENGTH      8 BITS
1340 ' STOP BIT LENGTH      1 BIT
1350 ' PARITY                ODD
1360 ' FLOW CONTROL         RS/CS
1370 ' BAUD RATE            (VALUE SET BY SWITCH COMMAND)
1380 COM(1) ON
1390 '
1400 *LV0 ' ..... Main Menu
1410 LV=0:SECT.NO=0:SEL.NO=1
1420 GOSUB *SELECT
1430 IF SEL.NO=0 THEN GOTO *PRO.END

```

```
1440 SECT.NO = SEL.NO
1450 '
1460 *LV1 ' ..... Sub-menu
1470 LV=1:SEL.NO=1
1480 GOSUB *SELECT
1490 IF SEL.NO=0 THEN GOTO *LV0
1500 *LV2 ' ..... Branch according to command (parameter input)
1510 COM(1) STOP
1520 LV=2:SEND$=CMND$(SECT.NO,SEL.NO,1)
1530 *SECT1
1540 IF SECT.NO<>1 THEN GOTO *SECT2
1550   ON SEL.NO GOSUB *ESC.0,*ESC.X
1560 *SECT2
1570 IF SECT.NO<>2 THEN GOTO *SECT3
1580   ON SEL.NO GOSUB *ESC.B,*ESC.C,*ESC.D,*ESC.2F
1590 *SECT3
1600 IF SECT.NO<>3 THEN GOTO *SECT4
1610   ON SEL.NO GOSUB *ESC.K,*ESC.Q,*ESC.R
1620 *SECT4
1630 IF SECT.NO<>4 THEN GOTO *SECT5
1640   ON SEL.NO GOSUB *ESC.U,*ESC.V
1650 *SECT5
1660 IF SECT.NO<>5 THEN GOTO *SECT6
1670   ON SEL.NO GOSUB *ESC.P,*ESC.T,*ESC.W
1680 *SECT6
1690 IF SECT.NO<>6 THEN GOTO *SECT7
1700   ON SEL.NO GOSUB *ESC.26,*ESC.29,*ESC.2A
1710 *SECT7
1720 IF SECT.NO<>7 THEN GOTO *SECT8
1730   ON SEL.NO GOSUB *ESC.21,*ESC.22,*ESC.23,*ESC.24,*ESC.25
1740 *SECT8
1750 IF SECT.NO<>8 THEN GOTO *SECT9
1760   ON SEL.NO GOSUB *ESC.2B,*ESC.4
1770 *SECT9
1780 IF SECT.NO<>9 THEN GOTO *LV2.END
1790   ON SEL.NO GOSUB *ESC.7,*ESC.8
1800 *LV2.END ' ..... Confirm transmission
1810 LOCATE 0,12:PRINT LEFT$(SEND$,56);
1820 IF LEN(SEND$)>56 THEN PRINT "... "
1830 LOCATE 66,12:PRINT "OK?";
1840 YN=1
1850 *YN.KY.IN
1860 LOCATE 74,12:COLOR 2+2*YN:PRINT "Y";:COLOR 2-2*YN:PRINT "N";
1870 A$=INKEY$:IF A$="" THEN GOTO *YN.KY.IN
1880 IF A$=CHR$(&H1C) OR A$=CHR$(&H1D) THEN YN=YN*(-1):GOTO *YN.KY.IN
1890 IF A$<>CHR$(&HD) THEN GOTO *YN.KY.IN
```

```

1900 LOCATE 66,12:COLOR 0:PRINT SPACE$(14);
1910 IF YN=-1 THEN GOTO *LV3.END
1920 GOSUB *SEND ' ..... Send command
1930 COM(1) ON
1940 LOCATE 43,9:COLOR 4:PRINT "Press ESC Key";:COLOR 0
1950 *SND.KY.IN
1960 A$=INKEY$:IF A$<>CHR$(&H1B) THEN *SND.KY.IN
1970 *LV3.END
1980 LOCATE 0,12:PRINT SPACE$(79);
1990 FOR I=0 TO 10
2000 LOCATE 39,I:PRINT SPACE$(40);
2010 NEXT I
2020 GOTO *LV1 ' ..... Return to Sub-menu
2030 '
2040 *PRO.END ' ..... End routine
2050 COM(1) OFF:CLOSE ' ..... Close communication port
2060 CONSOLE 0,25,0,1:CLS 3
2070 END
2080 '
2090 *SEND ' ..... Send command routine
2100 SND$=CHR$(&H1B)+MID$(SEND$,6)
2110 PRINT #1,SND$
2120 RETURN
2130 '
2140 *RCV ' ..... Receive interrupt routine
2150 IF LOC(1)=0 THEN GOTO *NORCV
2160 SX=POS(0):SY=CSRLIN
2170 LINE INPUT #1,RCV$
2180 LOCATE 0,RY:COLOR 0
2190 PRINT "[ESC]";MID$(RCV$,2)
2200 R.CODE$=MID$(RCV$,2,1)
2210 *ESC.Y ' ..... Notify screen number
2220 IF R.CODE$<>"Y" THEN GOTO *ESC.E
2230 PRINT "Screen Number : ";VAL("&H"+MID$(RCV$,3,4))
2240 PRINT:GOTO *RCV.END
2250 *ESC.E ' ..... Notify 4-digit number
2260 IF R.CODE$<>"E" THEN GOTO *ESC.F
2270 PRINT "Numeral table # : ";VAL("&H"+MID$(RCV$,3,3))
2280 PRINT "Input decimal value";VAL(MID$(RCV$,6,4))
2290 PRINT:GOTO *RCV.END
2300 *ESC.F ' ..... Notify 8-digit number
2310 IF R.CODE$<>"F" THEN GOTO *ESC.H
2320 PRINT "Numeral table # : ";VAL("&H"+MID$(RCV$,3,3))
2330 IF MID$(RCV$,6,1)="F" THEN NN=0-VAL(MID$(RCV$,7,7)) ELSE NN=VAL(MID$(RCV$,6,8))
2340 PRINT "Input decimal value : ";NN
2350 PRINT:GOTO *RCV.END

```

```

2360 *ESC.H ' ..... Notify touch switch (number)
2370 IF R.CODE$<>"H" THEN GOTO *ESC.J
2380 PRINT "Pressed touch switch number : ";VAL("&H"+MID$(RCV$,3,3))
2390 PRINT:GOTO *RCV.END
2400 *ESC.J ' ..... Notify touch switch (bit)
2410 IF R.CODE$<>"J" THEN GOTO *ESC.S
2420 PRINT "Pressed touch switch number : ";
2430 TS=0
2440 FOR I=0 TO 13
2450   S=VAL("&H"+MID$(RCV$,3+I*2,2))
2460   FOR J=0 TO 7
2470     IF (S MOD 2)=1 THEN PRINT TS;" ";
2480     S=S¥2:TS=TS+1
2490   NEXT J,I
2500 PRINT:PRINT:GOTO *RCV.END
2510 *ESC.S ' ..... Notify lamp and touch switch status
2520 IF R.CODE$<>"S" THEN GOTO *RCV.ERR
2530 PRINT "Lamp/touch switch number : ";VAL("&H"+MID$(RCV$,4,2))
2540 M=VAL(MID$(RCV$,3,1))
2550 IF M=0 THEN M$="OFF" ELSE IF M=1 THEN M$="ON" ELSE M$="INVERSE"
2560 PRINT "Display status          : ";M$
2570 PRINT:GOTO *RCV.END
2580 '
2590 *RCV.ERR
2600 PRINT "Receive data error"
2610 PRINT
2620 '
2630 *RCV.END
2640 RY=CSRLIN
2650 LOCATE SX,SY
2660 *NORCV
2670 RETURN
2680 '
2690 *ESC.0 ' ..... Display specified screen
2700 LOCATE 43,0:INPUT "Screen number : ",M
2710 M$=RIGHT$("000"+HEX$(M),4)
2720 SEND$=SEND$+M$
2730 RETURN
2740 *ESC.X ' ..... Screen # enquiry
2750 RETURN
2760 *ESC.B ' ..... Write character screen
2770 LOCATE 43,0:INPUT "Character-screen memory table number : ",M
2780 LOCATE 43,1:PRINT "Write character string (MAX 32 CHARACTERS) -->"
2790 LOCATE 43,2:INPUT C$
2800 M$=RIGHT$("0"+HEX$(M),2)
2810 C$=LEFT$(C$,32):L$=RIGHT$("0"+HEX$(LEN(C$)),2)

```

```

2820 SEND$=SEND$+L$+M$+C$
2830 RETURN
2840 *ESC.C ' ..... Write 4-digit number
2850 LOCATE 43,0:INPUT "Numeral table #      : ",M
2860 *NAGAIN
2870 LOCATE 43,1:INPUT "Write 1 to 4-digit number : ",N%
2880 IF N%<-999 OR N%>9999 THEN GOTO *NAGAIN
2890 IF N%<0 THEN S$="F" ELSE S$=""
2900 M$=RIGHT$("00"+HEX$(M),3)
2910 N%=ABS(N%)
2920 N$=STR$(N%):N$=RIGHT$(N$,LEN(N$)-1)
2930 IF S$<>"F" THEN N$=RIGHT$("000"+N$=RIGHT$("00"+N$,3)
2940 SEND$=SEND$+M$+S$+N$
2950 RETURN
2960 *ESC.D ' ..... Write 8-digit number
2970 LOCATE 43,0:INPUT "Numeral table #      : ",M
2980 *N8AGAIN
2990 LOCATE 43,1:PRINT SPACE$(36)
3000 LOCATE 43,1:INPUT "Write 1 to 8-digit number : ",N#
3010 N#=INT(N#)
3020 IF N#<-99999999# OR N#>99999999# THEN GOTO *N8AGAIN
3030 IF N#<0 THEN S$="F" ELSE S$=""
3040 M$=RIGHT$("00"+HEX$(M),3)
3050 N#=ABS(N#)
3060 N$=STR$(N#):N$=RIGHT$(N$,LEN(N$)-1)
3070 IF S$<>"F" THEN N$=RIGHT$("0000000"+N$,8) ELSE N$=RIGHT$("000000"+N$,7)
3080 SEND$=SEND$+M$+S$+N$
3090 RETURN
3100 *ESC.2F ' ..... Copy memory table
3110 LOCATE 43,0:INPUT "0: character string/1 : number ",M$
3120 IF M$<>"0"AND M$<>"1" THEN *ESC.2F
3130 LOCATE 43,1:INPUT "Copy source memory table number : ",S%
3140 LOCATE 43,2:INPUT "Copy destination memory table number : ",D%
3150 S$=STR$(S%):S$=RIGHT$(S$,LEN(S$)-1):S$=RIGHT$("00"+S$,3)
3160 D$=STR$(D%):D$=RIGHT$(D$,LEN(D$)-1):D$=RIGHT$("00"+D$,3)
3170 SEND$=SEND$+M$+S$+D$
3180 RETURN
3190 *ESC.K ' ..... Display lamps and touch switches (bits)
3200 FOR I=0 TO 31:TS.B(I)=-1:NEXT I
3210 FOR I=0 TO 31
3220   LOCATE 65-(I MOD 8)*3,I¥8:PRINT RIGHT$(STR$(I),2)
3230 NEXT I
3240 LOCATE 43,5:PRINT "Input # : Inverse Input : Run input 99 : Execute"
3250 *ESC.K.2
3260 COLOR 0:LOCATE 43,6:PRINT SPACE$(36)
3270 LOCATE 43,6:INPUT "Lamp/touch switch number : ";N

```

```
3280 IF N=99 THEN GOTO *ESC.K.3
3290 IF N<0 OR N>31 THEN GOTO *ESC.K.2
3300 TS.B(N)=TS.B(N)*(-1)
3310 COLOR 2+TS.B(N)*2
3320 LOCATE 65-(N MOD 8)*3,N/8:PRINT RIGHT$(STR$(N),2)
3330 GOTO *ESC.K.2
3340 *ESC.K.3
3350 FOR I=0 TO 3
3360   M=0
3370   FOR J=0 TO 7
3380     IF TS.B(I*8+J)=1 THEN M=M+2^J
3390   NEXT J
3400   SEND$=SEND$+RIGHT$("0"+HEX$(M),2)
3410 NEXT I
3420 COLOR 0
3430 RETURN
3440 *ESC.Q ' ..... Display lamps and touch switches (number)
3450 LOCATE 43,0:PRINT "Display specification"
3460 LOCATE 43,1:PRINT " 0 : OFF"
3470 LOCATE 43,2:PRINT " 1 : ON"
3480 LOCATE 43,3:PRINT " 2 : Inverse flashing (lamps only)"
3490 LOCATE 43,4:PRINT " 3 : All ON"
3500 *QAGAIN
3510 LOCATE 43,5:INPUT " : ",M$
3520 IF M$<>"0" AND M$<>"1" AND M$<>"2" AND M$<>"3" THEN GOTO *QAGAIN
3530 LOCATE 43,6:INPUT "Lamp/touch switch number : ",N
3540 N$=RIGHT$("00"+HEX$(N),2)
3550 SEND$=SEND$+M$+N$
3560 RETURN
3570 *ESC.R ' ..... Enquire lamp and touch switch status
3580 LOCATE 43,0:INPUT "Lamp/touch switch number : ",N
3590 N$=RIGHT$("00"+HEX$(N),2)
3600 SEND$=SEND$+N$
3610 RETURN
3620 *ESC.U ' ..... Disable inputs
3630 SEND$=SEND$+"0"
3640 RETURN
3650 *ESC.V ' ..... Enables inputs
3660 SEND$=SEND$+"0"
3670 RETURN
3680 *ESC.P ' ..... Display screen
3690 LOCATE 43,0:PRINT "Controlled item"
3700 LOCATE 43,1:PRINT " 0 : Display"
3710 LOCATE 43,2:PRINT " 1 : No display"
3720 *PAGAIN
3730 LOCATE 43,3:INPUT " : ",M$
```

```
3740 IF M$<>"0" AND M$<>"1" THEN GOTO *PAGAIN
3750 SEND$=SEND$+M$
3760 RETURN
3770 *ESC.T ' ..... Buzzer control
3780 LOCATE 43,0:PRINT "Controlled item"
3790 LOCATE 43,1:PRINT " 0 : Stop buzzer"
3800 LOCATE 43,2:PRINT " 1 : Continuous buzzer"
3810 LOCATE 43,3:PRINT " 2 : Intermittent buzzer"
3820 *TAGAIN
3830 LOCATE 43,4:INPUT " : ",M$
3840 IF M$<>"0" AND M$<>"1" AND M$<>"2" THEN GOTO *TAGAIN
3850 SEND$=SEND$+M$
3860 RETURN
3870 *ESC.W ' ..... System menu display
3880 LOCATE 43,0:PRINT "Controlled item"
3890 LOCATE 43,1:PRINT " 0:MENU TRANSFER ENABLE"
3900 LOCATE 43,2:PRINT " 1:MENU TRANSFER DISABLE"
3910 *WAGAIN
3920 LOCATE 43,3:INPUT " : ",M$
3930 IF M$<>"0" AND M$<>"1" THEN GOTO *WAGAIN
3940 SEND$=SEND$+M$
3950 RETURN
3960 '
3970 *ESC.26 ' ..... Clear screen
3980 RETURN
3990 *ESC.29 ' ..... Specify 1-byte character
4000 LOCATE 43,0:PRINT "Character specify size"
4010 LOCATE 43,1:PRINT " 0 : NORMAL SIZE (16x8)"
4020 LOCATE 43,2:PRINT " 1 : HALF SIZE (8x8)"
4030 *E26AGAIN
4040 LOCATE 43,3:INPUT " : ",M$
4050 IF M$<>"0" AND M$<>"1" THEN GOTO *E26AGAIN
4060 SEND$=SEND$+M$
4070 RETURN
4080 *ESC.2A ' ..... Specify character enlargement
4090 LOCATE 43,0:PRINT "Specify character enlargement"
4100 LOCATE 43,1:PRINT " 0:NO ENLARGEMENT"
4110 LOCATE 43,2:PRINT " 1:ENLARGE HEIGHT"
4120 LOCATE 43,3:PRINT " 2:ENLARGE WIDTH"
4130 LOCATE 43,4:PRINT " 3:2X2 ENLARGEMENT"
4140 LOCATE 43,5:PRINT " 4:3X3 TIMES ENLARGEMENT"
4150 LOCATE 43,6:PRINT " 5:4X4 TIMES ENLARGEMENT"
4160 *E2AAGAIN
4170 LOCATE 43,7:INPUT " : ",M$
4180 IF M$="0" OR M$="1" OR M$="2" THEN GOTO *E2ASEND
4190 IF M$="3" OR M$="4" OR M$="5" THEN GOTO *E2ASEND
```

```

4200 GOTO *E2AAGAIN
4210 *E2ASEND
4220 SEND$=SEND$+M$
4230 RETURN
4240 *ESC.21 ' ..... Normal display
4250 RETURN
4260 *ESC.22 ' ..... Set inverse display
4270 RETURN
4280 *ESC.23 ' ..... End inverse display
4290 RETURN
4300 *ESC.24 ' ..... Set flashing display
4310 RETURN
4320 *ESC.25 ' ..... End flashing display
4330 RETURN
4340 *ESC.2B ' ..... Set cursor position
4350 *E2B.X
4360 LOCATE 43,0:PRINT SPACE$(36)
4370 LOCATE 43,0:INPUT "X COORDINATE(000-255)",BX
4380 IF BX>639 OR BX<0 THEN *E2B.X
4390 *E2B.Y
4400 LOCATE 43,1:PRINT SPACE$(36)
4410 LOCATE 43,1:INPUT "Y COORDINATE(000-127)",BY
4420 IF BY>255 OR BY<0 THEN *E2B.Y
4430 BX$=STR$(BX):BX$=RIGHT$(BX$,LEN(BX$)-1):BX$=RIGHT$("00"+BX$,3)
4440 BY$=STR$(BY):BY$=RIGHT$(BY$,LEN(BY$)-1):BY$=RIGHT$("00"+BY$,3)
4450 SEND$=SEND$+BX$+BY$
4460 RETURN
4470 *ESC.4 ' ..... Specify Displayed Characters
4480 LOCATE 43,0:PRINT "Write character string (MAX. 32 CHARACTERS) -->|"
4490 LOCATE 43,1:INPUT C$
4500 C$=LEFT$(C$,32):L$=RIGHT$("0"+HEX$(LEN(C$)),2)
4510 SEND$=SEND$+L$+C$
4520 RETURN
4530 *ESC.7 ' ..... Draw Polyline
4540 LN=0:SL$=""
4550 *E7.X
4560 LOCATE 41,8:PRINT SPACE$(38)
4570 LOCATE 41,9:PRINT SPACE$(38)
4580 LOCATE 41,8:INPUT "X COORDINATE(END AT 999) : ",LX
4590 IF LX=999 THEN *E7.E
4600 IF LX<0 OR LX>255 THEN GOTO *E7.X
4610 *E7.Y
4620 LOCATE 41,9:PRINT SPACE$(38)
4630 LOCATE 41,9:INPUT "Y COORDINATE : ",LY
4640 IF LY<0 OR LY>127 THEN GOTO *E7.Y
4650 LX$=STR$(LX):LX$=RIGHT$(LX$,LEN(LX$)-1):LX$=RIGHT$("00"+LX$,3)

```



```

4660 LY$=STR$(LY):LY$=RIGHT$(LY$,LEN(LY$)-1):LY$=RIGHT$("00"+LY$,3)
4670 LOCATE 39+(LN MOD 5)*8,LN%5:PRINT LX$;" ";LY$;
4680 SL$=SL$+LX$+LY$
4690 LN=LN+1
4700 IF LN<40 THEN GOTO *E7.X
4710 *E7.E
4720 LN$=HEX$(LN-1):LN$=RIGHT$("0"+LN$,2)
4730 SEND$=SEND$+LN$+SL$
4740 RETURN
4750 *ESC.8 ' ..... Draw circle
4760 *E8.X
4770 LOCATE 43,0:PRINT SPACE$(36)
4780 LOCATE 43,0:INPUT "X COORDINATE OF CENTER OF CIRCLE : ",CX
4790 IF CX>255 OR CX<0 THEN *E8.X
4800 *E8.Y
4810 LOCATE 43,1:PRINT SPACE$(36)
4820 LOCATE 43,1:INPUT "Y COORDINATE OF CENTER OF CIRCLE : ",CY
4830 IF CY>127 OR CY<0 THEN *E8.Y
4840 *E8.R
4850 LOCATE 43,2:PRINT SPACE$(36)
4860 LOCATE 43,2:INPUT "?????#####",CR
4870 IF CR>63 OR CR<0 THEN *E8.R
4880 CX$=STR$(CX):CX$=RIGHT$(CX$,LEN(CX$)-1):CX$=RIGHT$("00"+CX$,3)
4890 CY$=STR$(CY):CY$=RIGHT$(CY$,LEN(CY$)-1):CY$=RIGHT$("00"+CY$,3)
4900 CR$=STR$(CR):CR$=RIGHT$(CR$,LEN(CR$)-1):CR$=RIGHT$("00"+CR$,3)
4910 SEND$=SEND$+CX$+CY$+CR$
4920 RETURN
4930 '
4940 *SELECT ' ..... Item selection routine
4950 IF LV=0 THEN LX=3 ELSE LX=LV*20+1
4960 IF LV=0 THEN LY=1 ELSE LY=0
5970 COLOR 4:LOCATE LX,LY:PRINT CMND$(SECT.NO,1,0)
5980 COLOR 0
5990 FOR I=2 TO CMND(SECT.NO)
5000   IF LV=0 AND I<=5   THEN LY=I
5010   IF LV=0 AND I>5   THEN LY=I+1
5020   IF LV=1           THEN LY=I-1
5030   LOCATE LX,LY:PRINT CMND$(SECT.NO,I,0)
5040 NEXT I
5050 *KY.IN
5060 A$=INKEY$:IF A$=""   THEN GOTO *KY.IN
5070 IF A$<>CHR$(&H1B)   THEN GOTO *KY1
5080   COLOR 0
5090   FOR I=1 TO CMND(SECT.NO)
5100     IF LV=0 AND I<=5 THEN LY=I
5110     IF LV=0 AND I>5  THEN LY=I+1

```

```
5120     IF LV=1             THEN LY=I-1
5130     LOCATE LX,LY:PRINT SPACE$(20)
5140     NEXT I
5150     SEL.NO=0
5160     GOTO *SEL.RET
5170 *KY1
5180 IF A$<>CHR$(&H1E) AND A$<>CHR$(&H1F) THEN GOTO *KY2
5190     IF LV=0 AND SEL.NO<=5 THEN LY=SEL.NO
5200     IF LV=0 AND SEL.NO>5 THEN LY=SEL.NO+1
5210     IF LV=1             THEN LY=SEL.NO-1
5220     COLOR 0:LOCATE LX,LY:PRINT CMND$(SECT.NO,SEL.NO,0)
5230     IF A$=CHR$(&H1E)      THEN SEL.NO=SEL.NO-1 ELSE SEL.NO=SEL.NO+1
5240     IF SEL.NO=0          THEN SEL.NO=CMND(SECT.NO)
5250     IF SEL.NO>CMND(SECT.NO) THEN SEL.NO=1
5260     IF LV=0 AND SEL.NO<=5 THEN LY=SEL.NO
5270     IF LV=0 AND SEL.NO>5 THEN LY=SEL.NO+1
5280     IF LV=1             THEN LY=SEL.NO-1
5290     COLOR 4:LOCATE LX,LY:PRINT CMND$(SECT.NO,SEL.NO,0)
5300     GOTO *KY.IN
5310 *KY2
5320 IF A$<>CHR$(&HD) THEN GOTO *KY.IN
5330 *SEL.RET
5340 COLOR 0
5350 RETURN
5360 DATA "SCREEN CONTROL","MEMORY TABLE OPERATION","LAMP, TOUCH SWITCH OPERATION"
5370 DATA "TOUCH SWITCH INPUT","SYSTEM CONTROL","CHARACTER SIZE"
5380 DATA "CHARACTER DISPLAY ATTRIBUTE","CHARACTER-STRING DISPLAY","FIGURE DISPLAY"
5390 DATA 2
5400 DATA "Display specified screen","[ESC]0"
5410 DATA "Request screen number","[ESC]X"
5420 DATA 4
5430 DATA "Write character-string memory table","[ESC]B"
5440 DATA "4-digit write numeral table","[ESC]C"
5450 DATA "8-digit write numeral table","[ESC]D"
5460 DATA "Copy memory table","[ESC]/"
5470 DATA 3
5480 DATA "Lamp and touch switch display (bit specification)","[ESC]K"
5490 DATA "Lamp and touch switch display (address specification)","[ESC]Q"
5500 DATA "Lamp and touch switch display status enquiry","[ESC]R"
5510 DATA 2
5520 DATA "Touch switch disable","[ESC]U"
5530 DATA "Touch switch enable","[ESC]V"
5540 DATA 3
5550 DATA "Screen display control","[ESC]P"
5560 DATA "Buzzer control","[ESC]T"
5570 DATA "Mode Transition Enable","[ESC]W"
```

```
5580 DATA 3
5590 DATA "Clear screen", "[ESC]&"
5600 DATA "Character specify size", "[ESC])"
5610 DATA "Specify character enlargement", "[ESC]*"
5620 DATA 5
5630 DATA "Normal display", "[ESC]!"
5640 DATA "Set inverse display", "#####"
5650 DATA "End inverse display", "[ESC]#"
5660 DATA "Set flashing display", "[ESC]$"
5670 DATA "End flashing display", "[ESC]%"
5680 DATA 2
5690 DATA "Set cursor position", "[ESC]+"
5700 DATA "Specify displayed characters", "[ESC]4"
5710 DATA 2
5720 DATA "Draw polyline", "[ESC]7"
5730 DATA "Draw circle", "[ESC]8"
```

SECTION 7

Troubleshooting and Maintenance

This section describes the action to take when NT20S errors occur, and how to carry out maintenance and inspections to prevent the occurrence of errors.

7-1	Hardware Faults	236
7-2	Responding to Displayed Error Messages	237
7-2-1	Errors Occurring when the Power is Turned ON	237
7-2-2	Errors Occurring During Operation	237
7-2-3	Errors Occurring on Screen Data Initialization	237
7-2-4	Communication Errors	237
7-3	Maintenance of the NT20S	239
7-4	Inspection and Cleaning	241

7-1 Hardware Faults

When a fault relating to the operation of the NT20S occurs, find the symptoms in the table below and respond by following the corresponding "Remedy" indicated in the table.

NT20S Symptoms	Cause	Remedy
POWER LED fails to come ON	Power is not being supplied.	Check the connections and make sure that power is supplied correctly. (Refer to "2-2-3 Power Supply Connection", page 29.)
	Power supply fuse has blown	Contact your OMRON service center.
Nothing is displayed on the screen (it is completely white).	Screen #0 has been read at the host side.	This is not an error. Change the screen number. (Refer to "4-3 Screen Display", page 122.)
Communication with the support tool not possible.	The Transmit Mode has not been established.	Display the system menu and select the Transmit Mode. (Refer to "3-6 Registering the Screen Data", page 86.)
	Not connected to the support tool.	Check the installation of the connector cable. (Refer to "2-3 Connecting to the Support Tool", page 31.)
	The PT type/direct connection settings made at the support tool do not agree with the NT20S.	Make the PT type setting and direct connection setting in the "tool settings" of the support tool agree with the NT20S.
Cannot communicate with the PC/Host.	Memory switch settings do not match.	Check the communication setting in the "Memory Switch" menu of the Maintenance Mode, and match the PC and NT20S settings. (Refer to "3-5 Setting the Conditions of Communications with the PC/Host by Using the Memory Switches", page 75.)
	NT20S and PC are not correctly connected.	Check that the type, length and installation of the connector cable match the specifications. (Refer to "2-4 Connection to a PC by the Host Link", page 32, "2-5 Connection to a PC by the NT Link", page 45, and "2-8 Host Connections by RS-232C", page 63.)
	When NT link (1:N), there is unit number duplication.	Set again with no duplication.
	Power not supplied to the NT20S, PC, or host	Check the power supply.
Buzzer sounds, RUN LED is OFF.	Malfunction due to external noise.	Distance the communication cable from the source of the noise and insert a noise filter in the power supply line.
Touch panel does not respond	Malfunction due to external noise	Distance the communication cable from the source of the noise and insert a noise filter in the power supply line.
	Touch panel is broken.	Check the touch panel by performing the touch panel test in the I/O check in the maintenance mode.
PC mode changes to monitor mode.	The NT20S changes the mode during host link communication.	This is normal with the NT20S specification. When using a PC that can also be connected using the NT link, connect it with the NT link (the mode is not changed when using the NT link).

7-2 Responding to Displayed Error Messages

When the NT20S displays an error message, find the corresponding symptoms in the appropriate table below and respond by following the “Remedy” indicated in the table.

7-2-1 Errors Occurring when the Power is Turned ON

The table below shows the errors that can occur when the power supply to the NT20S is turned ON, and their remedies.

Message	Cause	Remedy
Screen Data Corrupted	There is an error in the registered screen data.	After initializing the screen data memory in the Maintenance Mode, transmit the screen data once more with the support tool.
Mark Data Corrupted	There is an error in the registered mark data.	After initializing the screen data memory in the Maintenance Mode, transmit the screen data once more using the support tool.
No direct information is set! (NT20S-ST121-EV3/ ST122-V1)	The allocated words for the PT status control area and PT status notify area have not been set .	Use the support tool to set the head words of the PT status control area and PT status notify area, and transmit the screen data again.
	There is no screen data.	Transmit screen data from the support tool.

7-2-2 Errors Occurring During Operation

The table below shows the errors that can occur during operation of the NT20S, and their remedies.

Message	Cause	Remedy
Setting Error	Bits or words allocated to the PC memory cannot be found in the screen data.	Check the memory area in the PC used and correct the bit and word allocations in the screen data.
QQ command is not available	The PC cannot be connected to the NT20S.	Select a type of PC that can be connected to the NT20S.

7-2-3 Errors Occurring on Screen Data Initialization

The table below shows the errors that can occur when data is written to the NT20S screen data memory, and their remedies.

Message	Cause	Remedy
Initialization Error	Hardware fault or screen data memory life reached	If the same message is displayed even after executing screen data memory initialization or screen data transmission several times, contact your OMRON service center.

7-2-4 Communication Errors

This section describes the errors relating to communication with the PC/Host that can occur during operation, and their remedies.

- Operation when a communication error occurs

When a communication error occurs, the error message is displayed at the NT20S, and the buzzer sounds. Error messages are displayed when the “Automatic Reset” memory switch is not set.

Some error messages are displayed even if the “Automatic Reset” memory switch is set.

- Procedure when a communication error occurs

When an error message is displayed, press the [EXIT] touch switch displayed on the screen. The screen display will return to the RUN mode.

- Display of communication errors

As shown below, communication errors are displayed in the center of the screen, together with a classification indicating whether they are receive or send errors.

[Screen when an error has occurred during reception]

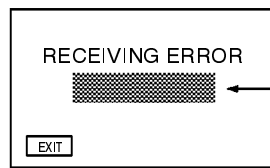

- <Error Description>
- Parity Error
 - Overrun Error
 - Overflow Error
 - Framing Error
 - Buffer Overflow
 - Time Out
 - NAK Received
 - Unit No. Error
 - FCS Error

[Screen when an error has occurred during sending]

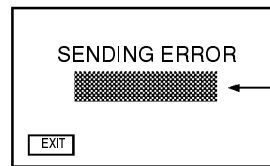

- <Type of error>
- Time Out

Message	Cause	Remedy
(ACIA) Parity Error Framing Error Overflow Error Overrun	Communication parameters/ conditions of communications set incorrectly.	Check whether the parity bit, frame length, baud rate, stop bit length, and flow control settings of the PC match the settings of the NT20S.
	Noise caused data corruption during communication.	Use a noise-resistant cable if communication occurs in an environment with high levels of noise.
	The connectors of the connecting cable are not connected correctly.	Reconnect the cable.
Buffer Overflow	The NT20S receive buffer is full.	Lengthen the command transmission intervals. If this error occurs frequently, set flow control for communications.
Time Out	The connectors of the connecting cable have become disconnected.	Reconnect the cable.
	The PC is stopped.	Make sure the PC is able to communicate with the NT20S.
	During transmission of one command, a time lapse exceeding 5 seconds is detected.	Confirm the proper command length. Reconnect the cable.
NAK Received (end code simultaneously displayed)	Noise caused data corruption during communication.	Use a noise-resistant cable if communication occurs in an environment with high levels of noise. Check the end code by referring to the PC user's manual.
Unit No. Error	The unit # does not match that set on the PC.	Set the PC unit # to "0".
	The PC is transmitting incorrect data.	Check PC operation.
	Noise caused data corruption during communication.	Use a noise-resistant cable if communication occurs in an environment with high levels of noise.
FCS Error	The PC is transmitting incorrect data.	Check PC operation.
	Noise caused data corruption during communication.	Use a noise-resistant cable if communication occurs in an environment with high levels of noise.

7-3 Maintenance of the NT20S

Carry out maintenance work in order to ensure that the NT20S is always used in its optimum condition.

 **WARNING:** Do not attempt to take the PC apart and do not touch any internal parts while the power is being supplied. Doing either of these may result in electrical shock.

Spare PT

It is advisable to have a spare NT20S available to minimize system downtime in the event of an NT20S failure or if the screen display becomes difficult to read due to deterioration of the display unit.

Backlight

When the backlight in the display is getting dim and the screen cannot be read easily, replace the backlight. The backlight can be replaced at the rear of the NT20S while it is mounted in an operation panel.

- Replaceable Backlight Model

NT20S-CFL01

- Guide to Backlight Replacement

Under normal conditions it can be assumed that the backlight will need to be replaced after about 20,000 hours. However, the life of the backlight does vary in accordance with the environment in which it is used and it should be replaced when it is getting dim and the screen is getting hard to read.

Replacing the Backlight

⚠ WARNING: Turn off the power before replacing the backlight. Otherwise you could sustain an electric shock.

- Operation**
1. Switch the power to the NT20S off, remove the screw from the backlight replacement cover using a Philips screwdriver, and open the cover. Then disconnect the backlight connector from the NT20S.

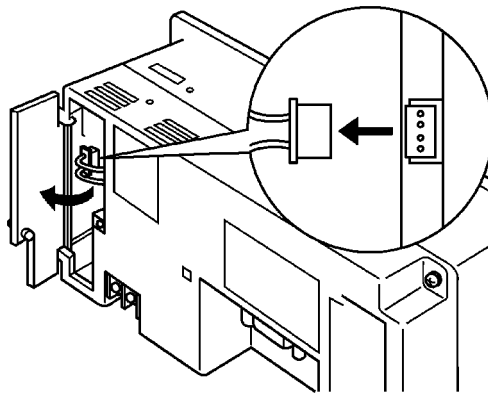

2. Pull out the T-shaped backlight loading tool and replace the backlight.

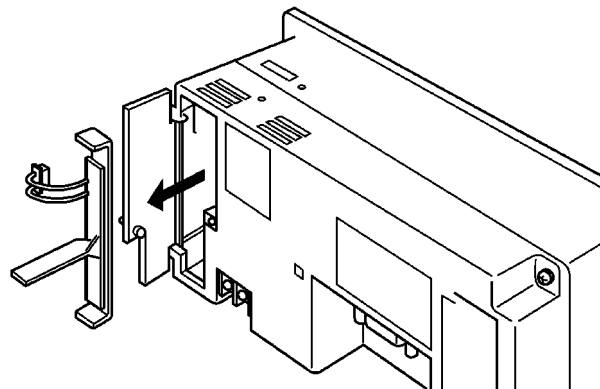

3. Re-install the backlight and connect its connector to the NT20S.
Close the cover and tighten the screw with a flat-head screwdriver.

7-4 Inspection and Cleaning

Clean and inspect the NT20S regularly to ensure that it is always used in its optimum condition.

Cleaning Method

If the display is dirty the screen is difficult to see. Clean the screen from time to time as follows.

- In daily cleaning, wipe the display with a soft dry cloth.
- If the soiling cannot be removed with a dry cloth, wet the cloth with water, wring it out well and wipe the display with it.
- If rubber or vinyl products, tape, etc. are left stuck to the display for long periods they will cause staining. If such items are stuck to the display, remove them during cleaning.

Note: Never use volatile solvents such as benzene or thinners, or dusters.

Inspection Method

In normal environments, inspect the NT20S at intervals of between 6 months and a year. In environments that are extremely hot and humid, or very dusty environments, shorten the inspection interval.

- Items required for the inspection

Prepare the following items before starting the inspection.

- The tools supplied with the NT20S
- Screwdrivers (Philips, flat-head)
- Tester (or digital voltmeter)
- Industrial alcohol
- 100% cotton cloth
- Hygrometer (required in some cases)
- Thermometer (required in some cases)
- Synchroscope (required in some cases)
- Pen-writing oscilloscope (required in some cases)

- Points inspected

Inspect the following points to determine if there is any divergence from the stated criteria. If there is, either improve the surrounding environment so that the values fall within the stated range, or adjust the NT20S.

Point Inspected	Inspection Details	Criterion	Inspection Instrument
Power supply voltage	Fluctuation in power supply terminal voltage	Permissible voltage fluctuation range (24 VDC -15% +10%)	Tester
Ambient environmental conditions	Ambient temperature (temperature in the operation panel)	0 to 50°C	Thermometer
	Ambient humidity (humidity in the operation panel)	35% to 85%RH	Hygrometer
	Presence/absence of dust	Dust must not be settled	Visual inspection
Mounting conditions	Looseness of mounting brackets etc.	To be no looseness	Accessory tools
	Connector connections of connecting cable	To be fully inserted and locked, with no looseness	
	Looseness of screws in external wiring	To be no looseness	Philips screwdriver
	Conditions of external connecting cables	Faults such as incipient disconnections.	Visual inspection
Components with limited lives	Brightness of the backlight	Must be sufficiently bright. Backlight life: Brightness is halved after about 20,000 hours in use.	Visual inspection

Note: • Do not attempt to disassemble the NT20S for repair or modification.

- The disposal of the NT20S (and used backlights) may be regulated by national or local authorities. Dispose of them in accordance with the laws and regulations of the relevant country and local authority.

Reference: When replacing the NT20S after discovering a fault during inspections, note the following points:

- Be sure to switch the power OFF before replacement.
- After replacement, check that the new NT20S is not subject to the same error.
- If a faulty unit is returned for repairs, write as detailed a description of the fault as possible and send this description together with the unit to the OMRON address indicated on the back cover of this book.

APPENDIX A

Specifications

General Specifications

Item	Specification
Power supply voltage	24 VDC
Allowable power supply voltage range	20.4 VDC to 26.4 VDC (24 VDC -15% +10%)
Power consumption	10 W max.
Inrush current	3 A max.
Ambient operating temperature	0 to +50°C (with no freezing)
Storage temperature	-20 to +70°C
Ambient operating humidity	35 to 85% RH (with no condensation)
Operating environment	No corrosive gases.
Resistance to electrostatic discharge	Level 3 (IEC801-2) In air ± 8 kV, contact ± 6 kV, indirect ± 7 kV
Electromagnetic field strength	10 V/m (IEC801-3)
Fast transient/burst noise	Power supply line: 2 kV (IEC801-4) I/O line: 0.25 kV
Damped oscillatory wave	Power supply line: 1 kV (IEC255-4)
Vibration resistance	10 to 22 Hz with 1.5 mm double amplitude for a total of 30 min. in X, Y, and Z directions. 22 to 500 Hz with 1.5 G {14.7 m/s ² } acceleration in X, Y, and Z directions.
Shock resistance	Durability: 30 G, 3 times each in X, Y, and Z directions. Malfunction: 20 G, 3 times each in X, Y, and Z directions.
Dimensions (mm)	190 (W) x 110 (H) x 58 (D) mm
Weight	0.7 kg max.
Enclosure ratings	Front panel: Equivalent to IP65 (front face waterproof construction). Rear case: IP20 Terminals: IP00
Applicable standards	IEC1131-2 (1992) EN50081-2 (1992)

Performance Specifications

Display Specifications

Item	Specification	
Dot matrix of STN liquid crystal display panel	Number of dots (resolution)	128 dots (vertically) x 256 dots (horizontally) (dot size: 0.407 mm)
	Effective display area	56 mm (vertically) x 112 mm (horizontally)
	Display mode *1	Blue mode (NT20S-ST12□) Monochrome mode (NT20S-ST16□)
	View angle	Left/right direction: $\pm 35^\circ$
	Life expectancy	50,000 hours minimum
Backlight (white cold cathode tube)	Life expectancy	10,000 hours minimum (average: 20,000 hours)*2
	Automatic turn-off	Can be set to turn off in 10 minutes or 1 hour, or to remain on.
Indicators	POWER indicator (Green LED)	Lit while power is being supplied.
	RUN indicator (Green LED)	Lit during operation

*1: The contrast in the monochrome mode is five times that in the blue mode.

*2: This is the time it takes for the brightness to decline to half its original value under normal temperature and humidity conditions.

Panel Specifications

Item	Specification
Touch panel	Number of switches: Max. 72 registerable per screen (6 vertically x 12 horizontally)
	Input: Pressure-sensitive type
	Operating force: 100 gf min.
	Life expectancy: 1 million operations minimum

Display Capacity

Item		Specification	
		NT20S-ST121-EV3/ST122-V1	NT20S-ST128
Display elements	Character displays	Fixed character data (character strings registered for each screen)	
	Character string displays	128 strings per file (32 bytes per string), 32 positions per screen	
	Numeral displays*	50 positions per screen, 8-digit display	
	Graph displays*	50 per screen	
	Graphic displays	Can be displayed wherever required	
	Lamps	128 per screen	Max. 256 strings per file
	Touch switches	72 per screen	Max. 256 strings per file
	Numeral settings*	Display of set numerical values 50 per screen	
Screen types	Normal screen	Displays screens registered as normal.	
	Overlapping screens	A maximum of 8 registered screens can be displayed overlapped with each other.	
	Continuous screens	A maximum of 8 screens can be displayed sequentially by scrolling. (The screen can be changed by pressing the \uparrow and \downarrow touch switches)	
Screen attributes		Buzzer, numeral setting	
Max. number of registered screens		495	
Screen registration method		Transfer screen data created using the support tool to the PT.	
Screen saving method (screen data memory)		Saved to flash memory (recording format unique to NT20S)	

*: Number of numeral memory tables that can be set (number used for numeral display + number used for graphs + number used for numeral settings) ≤ 128

Display Element Specifications

Item	Specification
Display characters	Half-size characters (8 x 8 dots): Alphanumerics and symbols
	Normal characters (8 x 16 dots): Alphanumerics and symbols
	Marks (16 x 16 dots): User-defined pictographs
Enlargement function	Horizontal and vertical magnifications of double width, double height, 4x, 9x, and 16x
Smoothing processing	Enlarged characters up to 4x
Character display attributes	Normal, inverse, flashing, inverse flashing
Graphics	Continuous straight lines, circles

Data Quantities

Item	Specification	
	NT20S-ST121-EV3/ST122-V1	NT20S-ST128
Strings	128 strings comprising 32 characters each	
Numeral data	128 max. (8 digits each)	
Marks	64 marks	
Touch switches	No maximum restriction	Max. 256 strings per file
Lamps	No maximum restriction	Max. 256 strings per file

Special Features

Item	Specification
Buzzer	<p>Two types: Continuous sound and intermittent sound</p> <p>Setting: Set "key press sound" in the "Memory Switch" menu of the Maintenance Mode ON.</p> <p>If "ERR ON" is set the buzzer only sounds when an error occurs.</p> <p>ON: The buzzer sounds on designation from the PC, when a screen with a buzzer-ON specification is called, or on display of an error screen such as for a receive error.</p> <p>OFF: The buzzer is turned off on designation from the PC, by touch switch input, or when a screen without a buzzer-ON specification is displayed.</p> <p>Sound pressure: Min. 80 dB, average 87 dB (measured 10 cm from front face)</p>
Maintenance functions	<ul style="list-style-type: none"> • Self-test for memory, switches, etc. • Status setting confirmation for communications and other conditions. • Simple communications confirmation.
Key input sound setting	<p>0.2 second input sound when a touch switch is pressed</p> <p>Setting: Set "key press sound" of the "Memory Switch" menu in the Maintenance mode ON.</p>

Communications Specifications**[For a Host Link] (NT20S-ST121-EV3)**

Item	Specification
Communications standard	EIA RS-232C
Communications settings	<p>Start-stop synchronization</p> <p>Baud rate: 9600, 19,200 bps</p> <p>Data length: 7 bits</p> <p>Stop bit: 2 bits</p> <p>Parity: Even</p>
Connector	9-pin, D-SUB connector (female)
Number of units connected	1 to 1
Transmission distance	Max. 15 m
Communications protocol	C-series SYSWAY (1:N)

[For an NT Link (1 to 1)] (NT20S-ST121-EV3)

Item	Specification
Communications standard	EIA RS-232C
Connector	9-pin D-SUB connector (female)
Number of units connected	1 to 1
Transmission distance	Max. 15 m

[For an NT Link (1:N)] (NT20S-ST121-EV3)

Item	Specification
Communications standard	EIA RS-232C
Connector	9-pin D-SUB connector (female)
Number of units connected	1:1 to 8
Transmission distance	<ul style="list-style-type: none"> • RS-232C cable : Max. 2 m (*) • RS-422A/485 cable : Total length 500 m (*)

(*) When NT-AL001 used

[For RS-232C] (NT20S-ST128)

Item	Specification
Communication standard	EIA RS-232C
Communication settings	Start-stop synchronization Baud rate: 2400/4800/9600/19200 (bps) Data length: 7, 8 bits Stop bit: 1, 2 bits Parity: Even/Odd/None Flow control:RS/CS control XON/XOFF control None
Connector	9-pin D-SUB female
Number of units connected	1-to-1
Transmission distance	Max. 15 m

APPENDIX B

Dimensions

[Outside Dimensions]

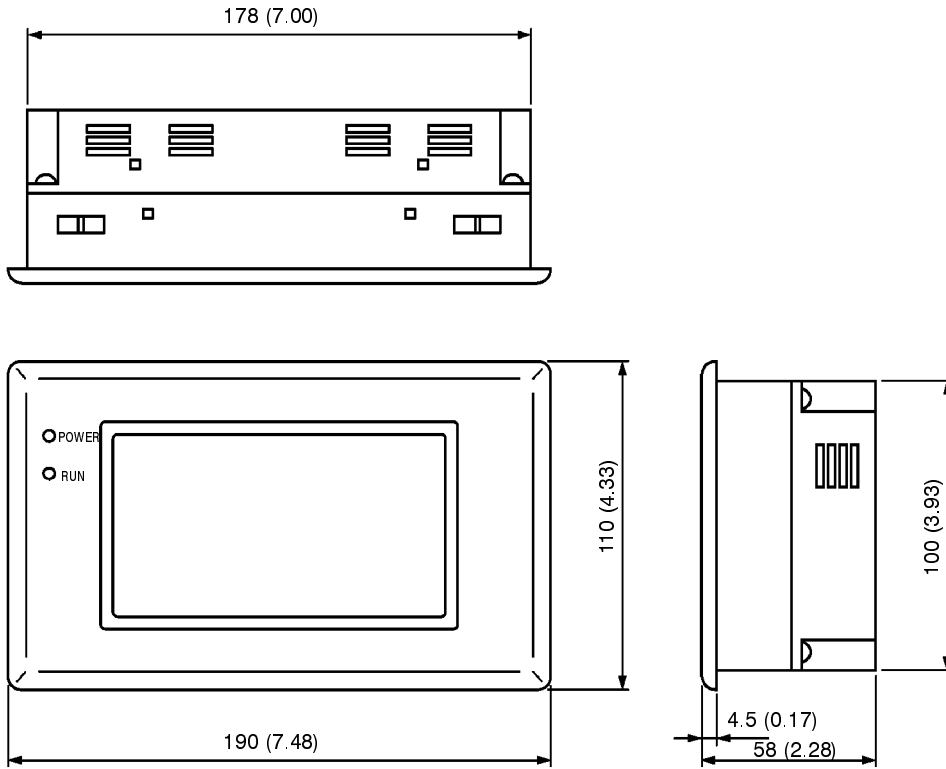

[Dimensions for Installation]

Unit: mm (in.)

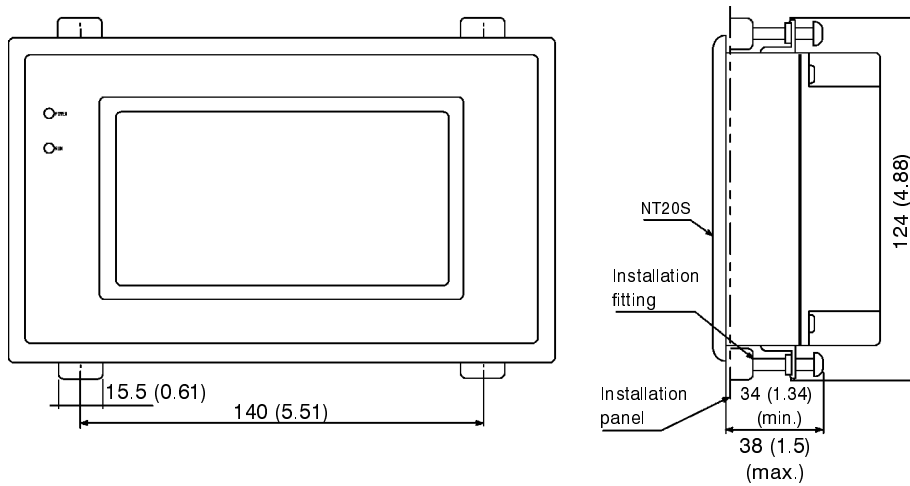

Unit: mm (in.)

APPENDIX C

Handling the RS-232C/RS-422A Converter Unit

This section shows the dimensions of the RS-232C/RS-422A converter unit (NT-AL001), and describes the methods for installing and removing it. Refer to this information when designing the control panel.

Dimensions

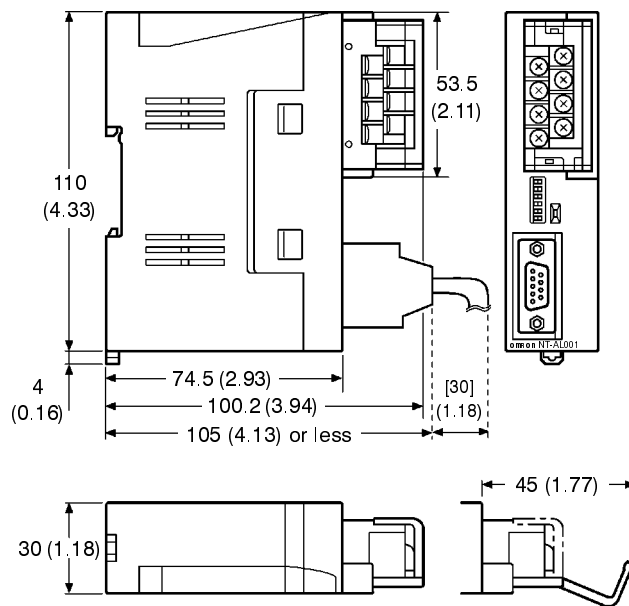

Unit = mm (in.)

With RS-422A terminal block cover closed:

30 [1.18] (W) x 114 [4.49] (H) x 100.2 [3.94] (D) mm [in.]

With RS-422A terminal block cover open:

30 [1.18] (W) x 114 [4.49] (H) x 119.5 [4.7] (D) mm [in.]

Installation and Removal

The RS-232C/RS-422A converter unit (NT-AL001) is installed on a DIN rail or in an operation panel. The RS-422A terminal block of the converter unit can easily be removed.

Installation on a DIN Rail

Hook the top part of the rear of the converter unit ((a) in the figure) onto the top edge of the DIN rail, and push the unit in direction (b).

Then fit end plates on the right and left sides of the converter unit so that the unit cannot shift sideways.

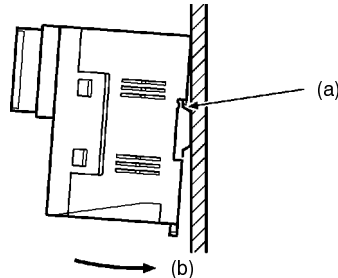

Removal from the DIN Rail

Remove the end plates at right and left, then insert a flat-tipped screwdriver into the rail stopper on the bottom of the unit and pry the unit away.

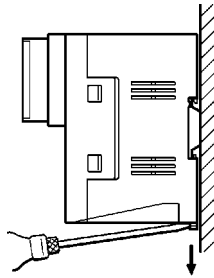

Installation in an Operation Panel

Make two screw holes in an operation panel wall at least 2 mm thick and secure the converter to the wall with screws.

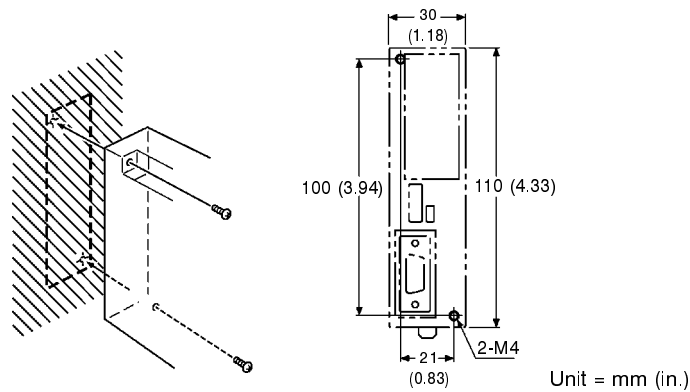

Note: In order to ensure a strong installation, the wall of the operation panel must be at least 2 mm thick.

APPENDIX D

NT20S Installation Environment

When installing the PT in the operation panel, observe the following points. See also the section “Getting Starting”.

- The view angle of the LCD display screen is 40°. Install it at a position and height where operators will be able to see it well.

**Caution:**

- Do not install at a site exposed to chemicals, steam, etc, or subject to excessive airborne dust.
- Do not install the unit at locations where the ambient temperature goes outside the range 0 to 50°C or where the relative humidity goes outside the range 35 to 85% RH.
If the ambient temperature exceeds the range indicated above, install a fan or an air conditioner.
- Do not install the unit directly above equipment that generates a lot of heat (heaters, transformers, large capacity resistors, etc.)
- Take the following points into account in order to prevent noise
 - (4) Avoid installing the unit in panels in which high-voltage equipment is also installed.
 - (5) Install the unit at a distance of at least 200 mm from power lines.
 - (6) If the unit is installed next to equipment that generates a strong electric or magnetic field (solenoids, etc.), provide a gap of at least 40 mm.
- Secure sufficient space for ventilation.
- Do not install in sites subject to severe vibration or strong shocks.
- Install at a distance from high-voltage devices and power equipment in consideration of operability and safety during maintenance.

Note:

- The angle of visibility of the LCD display screen is 35 degrees to left and right. Install it at a position, height, and orientation that will make it easy for personnel to see it.
- Install the PT at a location as far as possible from personal computers, radio equipment, radios, etc. The electromagnetic waves generated by the PT will cause radio interference.
- When using the RS-232C +5V output, check the current capacity of the connected equipment. The maximum current value of the NT20S +5 V output is 150 mA.

Transportation and Storage of the PT

Note on transportation

Pack the PT in the packaging intended for it before transporting it.

Note on storage

Maintain the storage ambient temperature (-20 to 70 °C) and storage ambient humidity (35 to 85% RH).

APPENDIX E

NT20S Internal Processing

When the direct connection function is used, the following processing is executed inside the NT20S. Processing is divided into two types: periodic processing and event processing.

Periodic Processing (When Using Direct Connection)

The following processing is executed inside the NT20S to enable high-speed control from the PC.

Usually, the only data read from the PC area the elements used for the currently displayed screen. Even if the contents of the PC words allocated to memory tables are changed, these contents are not updated at the PT unless the memory table is used for the displayed screen.

[NT20S (PT) processing]

[Details of processing]

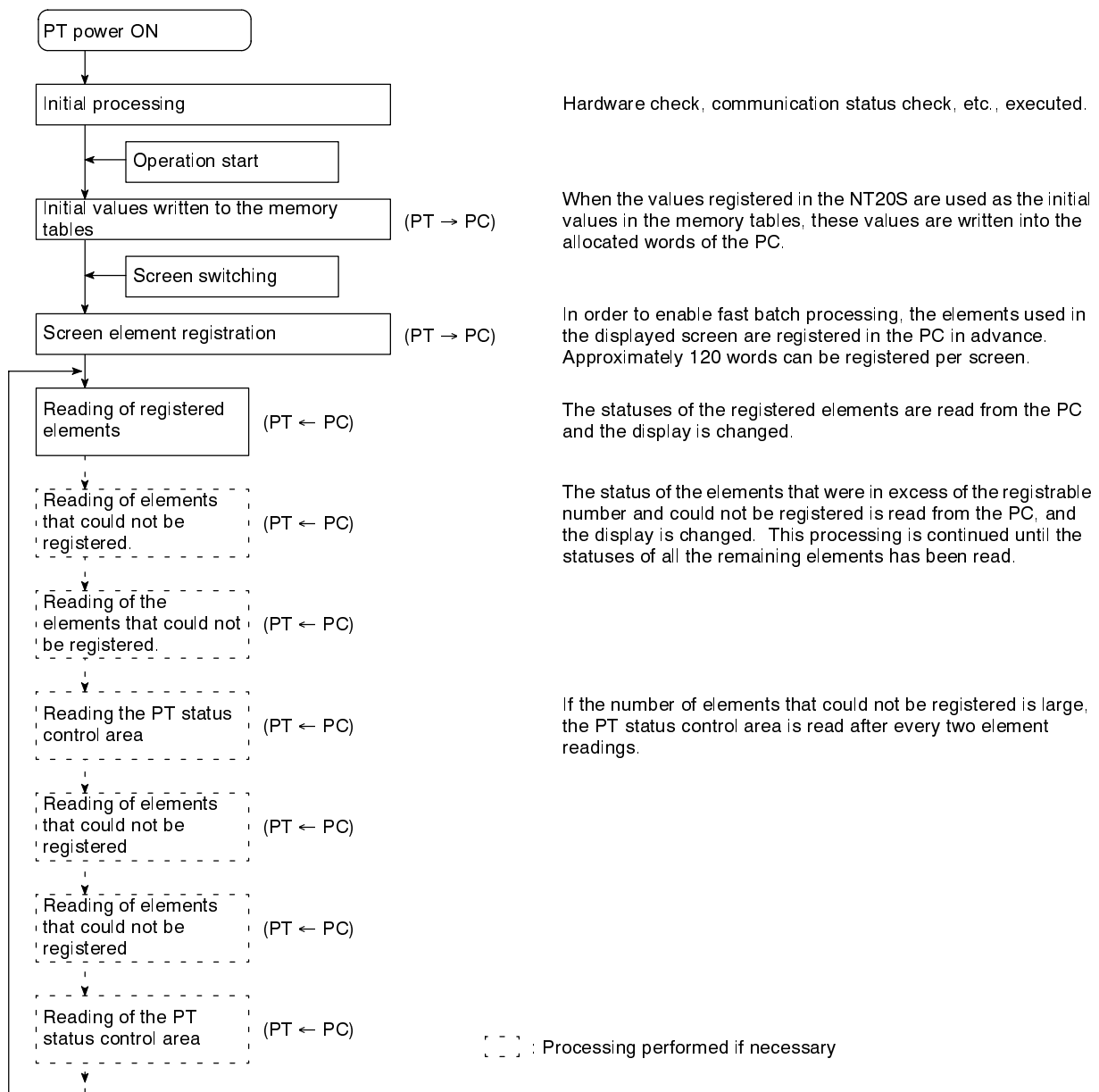

Hardware check, communication status check, etc., executed.

When the values registered in the NT20S are used as the initial values in the memory tables, these values are written into the allocated words of the PC.

In order to enable fast batch processing, the elements used in the displayed screen are registered in the PC in advance. Approximately 120 words can be registered per screen.

The statuses of the registered elements are read from the PC and the display is changed.

The status of the elements that were in excess of the registrable number and could not be registered is read from the PC, and the display is changed. This processing is continued until the statuses of all the remaining elements has been read.

If the number of elements that could not be registered is large, the PT status control area is read after every two element readings.

[] : Processing performed if necessary

- Number of words for screen element registration

The number of words used for screen element registration is as follows.

Allocated words: Number of words

Allocated bits : Number of words calculated by summing the number of bits in each area and taking 1 word to be 16 bits.

[Example]

Character string memory tables : 3 of 12 allocated words each

Numeral memory tables : 4 of 2 allocated words each

Allocated bits for control : 19 I/O relays, 7 link relays (contiguous bits)

The number of words assigned to character string memory tables and numeral memory tables is as follows:

$$12 \text{ words} \times 3 + 2 \text{ words} \times 4 = 44 \text{ words}$$

The assignment for bits is as follows:

$$19 \text{ I/O relays} \div 16 = 1 \text{ word with a remainder of 3 bits} \rightarrow 2 \text{ words}$$

$$7 \text{ link relays} \div 16 = 0 \text{ words with a remainder of 7 bits} \rightarrow 1 \text{ word}$$

The total is therefore 44 words + 2 words + 1 word = 47 words

Elements occupying up to approximately 120 words, calculated in this way, can be registered. If the number of elements is larger than this, internal processing is increased in proportion to the excess number and this generates a delay in processing.

If the point where the registrable quantity is exceeded is in the middle of an element that spans several words (for example a character string memory table), registration is quit without registering that element.

- Order of priority for registration

Elements are registered in the following order of priority according to their type.

- (1) Allocated words of the PT status control area
- (2) Allocated bits for control (lamps, touch switches)
- (3) Allocated words of numeral memory tables
- (4) Allocated words of character string memory tables

If there is more than one element for each of (2) through (4), the elements are registered in accordance with the following priority of word and bit areas:

- (1) Data memory (DM)
- (2) I/O relays (CH)
- (3) Timers (TIM)
- (4) Counters (CNT)
- (5) Holding relays (HR)
- (6) Auxiliary relays (AR)

Within each area, words and bits are allocated from the smallest number up.

Event Processing (When Using Direct Connection)

When the status of the NT20S changes during operation, the processing for writing the changed data to the relevant area of the PC memory is executed.

This kind of processing is only executed when statuses change. When changes occur simultaneously, the processes are executed in accordance with the order of priority.

	[NT20S processing]	[Details of processing]
High	Writing to PT status notify area (PT → PC)	Writing to the PT status notify area in order to inform the PC of changes in the PT operation status.
	Bit writing (PT → PC)	Updating the contents of words allocated to the PC when the value in a numeral memory table has changed.
	Writing to numeral memory tables (PT → PC)	Updating the contents of words allocated to the PC when the contents of a character string memory table have changed.
Low	Writing to character string memory tables (PT → PC)	Writing to bits in order to inform the PC of touch switch statuses.

Data is only written to PC bits and numeral/character string memory tables for elements in screens currently being displayed. If the contents of numeral/character string memory tables that are not being displayed change, the changed data is not written to the PC.

APPENDIX F

Function Restrictions Depending on the Support Tool

Screens can be created for an NT20S-ST121-EV3/ST122-V1 by using the conventional support tools indicated below.

- NT series NT20M/NT2000M/NT600M support tool (Ver.4.□)

In addition, the NT series support tool (Ver.2.□) can be used with Ver.4 of the direct connection function.

However, when the above support tools are used or Ver.4 direct connection is used, restrictions apply to some functions, as shown in the table below.

The expressions used for support tools in the table have the following meanings.

NTM V4 : NT series NT20M/NT2000M/NT600M support tool (Ver.4.□)

NT V2 : NT series support tool (Ver.2.□)

Support Tool	NT Model	Direct Connection	Communication Mode	Support Tool Mode (NT20S memory switch)	Restrictions
NTM V4	NT20M	OMRON	- (Standard)	NT20M	Max. 250 screens, Thumb-wheel numeral settings not possible, no upper/lower limits, hexadecimal input not possible, indirect specification not possible, touch switch input notification fixed as "momentary", data transmission in screen units not possible.
NT V2	NT20M	Ver. 4	Standard	NT20M	
	NT20S	Ver. 4	Standard/High-speed	NT20S	
	NT20S	Ver. 5	Standard/High-speed	NT20S	No restriction

The NT20S cannot be used with combinations of support tools and settings other than those indicated above.

Reference: The NT20S-ST128 can be used in the same way with the NT series support tool (Ver.2.□). The necessary support tool and "Support Tool Mode" (NT20S memory switch) settings in this case are as follows:

NT Model : NT20S
 Direct setting : No
 Communication mode : Standard/High-speed
 Support Tool Mode : NT20S

APPENDIX G

Method for Making the Cable for Connection to the Host

Explained below is the method for making the cable that connects the NT20S-ST121-EV3/ST128 with the PC. Connect the wires to the connectors in accordance with the connector specification for each unit.

Parts Required

Two connectors, two connector covers and one cable are required to make up a connecting cable. One connector and one connector cover is supplied with most PCs.

The parts supplied with each unit are indicated in the table below.

Name	Model	Delivered with	Remarks
Connector	XM2A-0901	C series CQM1 CVM1/CV series CPU unit CV500-LK201	9-pin, manufactured by OMRON
	XM2A-2501	C500-LK203 C500-LK201 C200H-LK201	25-pin, manufactured by OMRON
	DB-25P	C500-LK201-V1 C120-LK201-V1	25-pin, manufactured by JAE
Connector cover	XM2S-0911	C series CQM1 CVM1/CV series CPU unit CV500-LK201	9-pin, manufactured by OMRON
	XM2S-2511	C500-LK203 C500-LK201 C200H-LK201	25-pin, made by OMRON
	DB-C2-J9	C500-LK201-V1 C120-LK201-V1	25-pin, made by JAE

When connecting the NT20S to a C□□H PC manufactured by OMRON, the connector and connector hood must be prepared separately since they are not supplied with the C□□H.

The connector provided in the CPU unit of the C□□H is a 9-pin connector. For the connection, the following connector and connector hood should be prepared.

- Connector : XM2A-0901 (9-pin, OMRON)
- Connector cover : XM2S-0911 (9-pin, OMRON)

Use the cable recommended by OMRON.

The recommended cables are indicated in the table below.

Name	Model	Remark
Cable	AWG28×5P IFVV-SB	Multiconductor shielded cable (FUJIKURA, Ltd.)
	CO-MA-VV-SB 5P×28AWG	Multiconductor shielded cable (HITACHI Cable, Ltd.)

Connector Specifications and Wiring for OMRON Units

The combination of pin numbers to which the connecting wires are connected differs according to the connector specifications for each unit. Check the connector specifications of the unit to be connected and make the wiring connections for the items in the connection combination indicated below which are applicable.

[NT20S Connector Specifications (9-pin)]

- Electrical characteristics: Complies with EIA RS-232C
- Signal direction: Signal input and output is relative to NT20S.

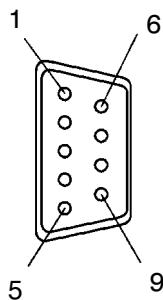

Connector Pin No.	Signal Name	Abbreviation	Signal Direction	
			Input	Output
2	Send data	SD (TXD)		○
3	Receive data	RD (RXD)	○	
4	Request to send	RS (RTS)		○
5	Clear to send	CS (CTS)	○	
6	+5 V output, 150 mA max.	+5V		○
9	Signal ground	SG	-	-

Correct Use: If using the +5 V supply of pin No.6, check first that the equipment that is to receive the supply has a current capacity no greater than 150 mA. The +5 V output of the NT20S is +5 V ± 5%, max. 150 mA.

Connecting an NT20S to a C-Series Host Link

- C-Series Host Link Unit 25-pin Connector Specifications

Applicable Host Link Unit: C200H-LK201(-V1)
 C500-LK201-V1
 C500-LK203
 C120-LK201-V1

- Electrical characteristics: Complies with EIA RS-232C
- Signal direction: Signal input and output is relative to the PC.

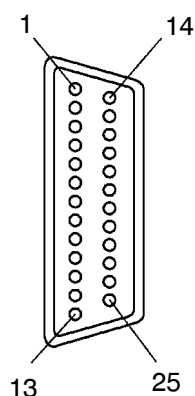

Connector Pin No.	Signal Name	Abbreviation	Signal Direction	
			Input	Output
1	Frame ground	FG	-	-
2	Send data	SD (TXD)		○
3	Receive data	RD (RXD)	○	
4	Request to send	RS (RTS)		○
5	Clear to send	CS (CTS)	○	
7	Signal ground	SG (GND)	-	-
14	Optical connector +5V (see note 2)	+5V	-	-
15	Send signal element timing 2 (see note 1)	ST2	○	
17	Receive signal element timing (see note 1)	RT	○	
20	Data terminal ready	ER (DTR)		○
24	Data signal element timing (see note 1)	ST1		○

Note 1. No element timing signals on C200H-LK201(-V1)
 2. C500-LK201 and C200H-LK201(-V1) only

• Wiring Connections

The NT20S does not use pin 4 (RS) or pin 5 (CS). Either short the RS and CS pins of the PC connector together or set the CTS setting selector switch at the rear face of the host link unit to "0V" (see * in the figure).

Connect the cable shielding wire to the connector cover and pin 1 at the host link unit end of the cable only.

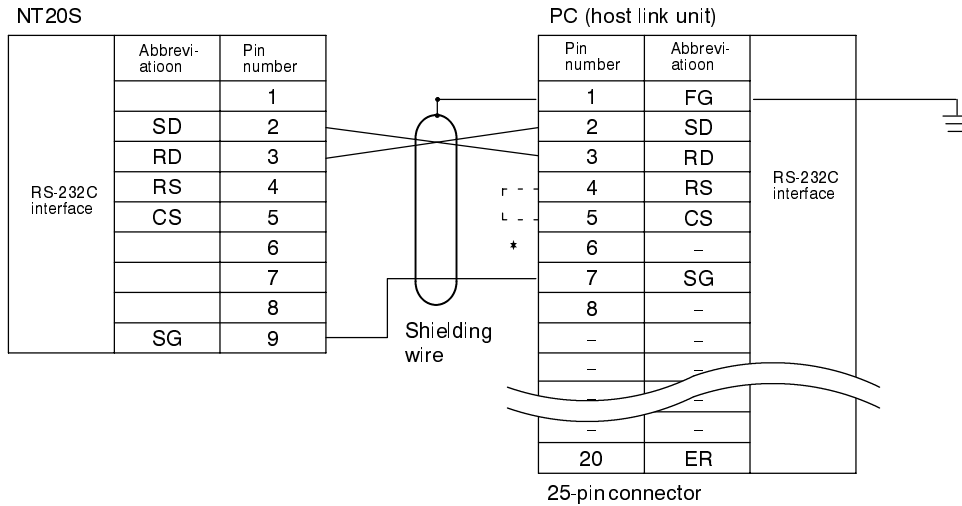

Connecting an NT20S to a C-Series CPU (C□□H)

• C-Series CPU Unit (C□□H) 9-pin Connector Specifications

- Applicable CPU: C20H/C28H/C40H/C60H
- Electrical characteristics: Complies with EIA RS-232C
- Signal direction: Signal input and output is relative to the PC.

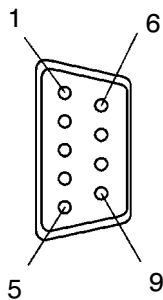

Connector Pin No.	Signal Name	Abbreviation	Signal Direction	
			Input	Output
1	Frame ground	FG	-	-
2	Send data	SD (TXD)		○
3	Receive data	RD (RXD)	○	
4	Request to send	RS (RTS)		○
5	Clear to send	CS (CTS)	○	
7	Signal ground	SG (GND)	-	-

• Wiring Connections

The NT20S does not use pin 4 (RS) or pin 5 (CS). Short the RS and CS pins of the PC connector together (see * in the figure).

Connect the cable shielding wire to the connector cover and pin 1 at both the NT20S and CPU ends of the cable.

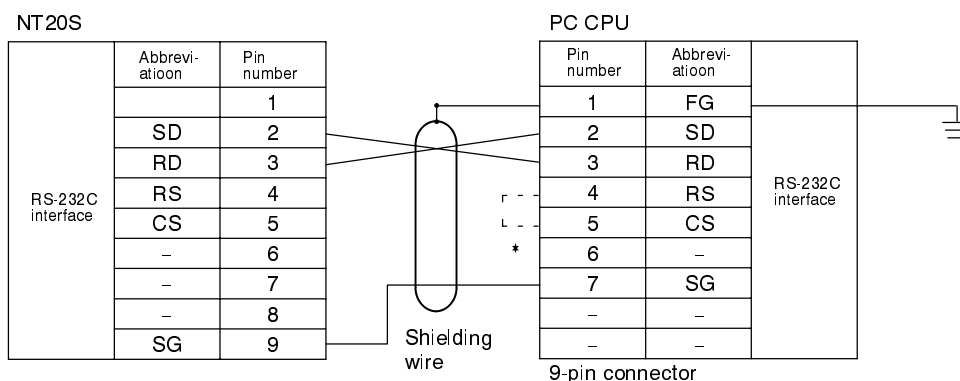

Connecting an NT20S to a CVM1/CV-Series Host Link Unit

• CVM1/CV-Series Host Link Unit Connector Specifications

- Applicable host link unit: CV500-LK201
- Electrical characteristics: Complies with EIA RS-232C
- Signal direction: Signal input and output is relative to the PC.

Communication Port 1 (25-pin Connector)

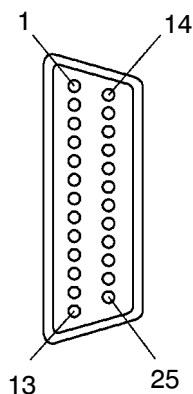

Connector Pin No.	Signal Name	Abbreviation	Signal Direction	
			Input	Output
Connector cover	Frame ground	FG	-	-
1	Frame ground	FG	-	-
2	Send data	SD (TXD)		○
3	Receive data	RD (RXD)	○	
4	Request to send	RS (RTS)		○
5	Clear to send	CS (CTS)	○	
7	Signal ground	SG (GND)	-	-
8	Carrier detected	CD (DCD)	○	
14	Optical connector +5V	+5V	-	○
20	Data terminal ready	ER (DTR)		○

Communication Port 2 (9-pin Connector)

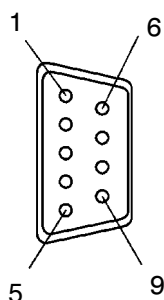

Connector Pin No.	Signal Name	Abbreviation	Signal Direction	
			Input	Output
Connector cover	Frame ground	FG	-	-
2	Send data	SD (TXD)		○
3	Receive data	RD (RXD)	○	
4	Request to send	RS (RTS)		○
5	Clear to send	CS (CTS)	○	
9	Signal ground	SG (GND)	-	-

• Wiring Connections

CVM1/CV-series host link units have two types of connector, which must be wired differently.

The NT20S does not use pin 4 (RS) or pin 5 (CS). Either short the RS and CS pins of the PC connector together or set the CTS setting selector switch at the rear face of the host link unit to "0V" (see * in the figure).

Connect the cable shielding wire to the connector cover and pin 1 at the host link unit end of the cable only.

Communication Port 1 (25-pin Connector)

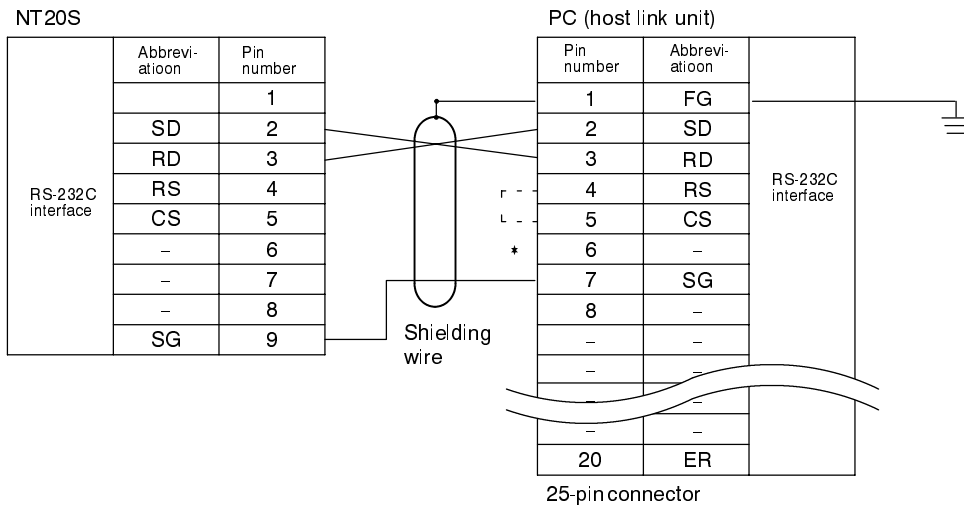

Communication Port 2 (9-pin Connector)

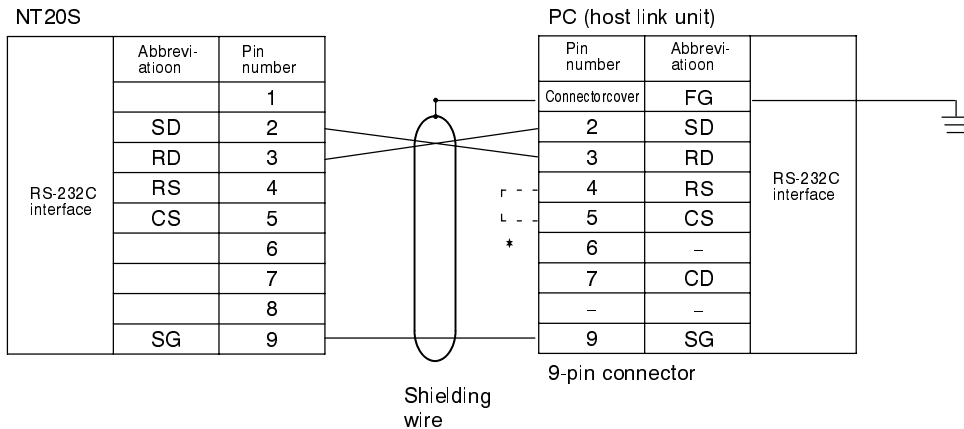

Connecting an NT20S to a C-Series C200HS, C200HX/HG/HE, CPM1, CQM1, CVM1/CV-Series (-EV□)CPU

- C-Series C200HX/HG/HE, CPM1, CQM1, CVM1/CV-Series (-EV□) CPU Unit 9-pin Connector Specifications

Applicable CPU:

CQM1-CPU21-E	CV2000-CPU01-EV□	C200HS-CPU33-E	C200HX-CPU34-E
CQM1-CPU41-E	CVM1-CPU01-EV□	C200HE-CPU32-E	C200HX-CPU44-E
CQM1-CPU42-E	CVM1-CPU11-EV□	C200HE-CPU42-E	C200HX-CPU54-E
CQM1-CPU43-E	CVM1-CPU21-EV□	C200HG-CPU33-E	C200HX-CPU64-E
CQM1-CPU44-E	C200HS-CPU21-E	C200HG-CPU43-E	
CV500-CPU01-EV1	C200HS-CPU23-E	C200HG-CPU53-E	
CV1000-CPU01-EV1	C200HS-CPU31-E	C200HG-CPU63-E	

Note: The host link function incorporated in CV/CVM1 CPUs (with the exception of -EV□) cannot be used.

- Electrical characteristics: Complies with EIA RS-232C
- Signal direction: Signal input and output is relative to the PC.

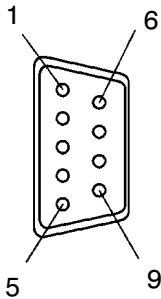

Connector Pin No.	Signal Name	Abbreviation	Signal Direction	
			Input	Output
Connector cover	Frame ground	FG	-	-
2	Send data	SD (TXD)		○
3	Receive data	RD (RXD)	○	
4	Request to send	RS (RTS)		○
5	Clear to send	CS (CTS)	○	
9	Signal ground	SG (GND)	-	-

• Wiring Connections

The NT20S does not use pin 4 (RS) or pin 5 (CS). Either short the RS and CS pins of the PC connector together or set the CTS setting selector switch at the rear face of the host link unit to "0V" (see * in the figure).

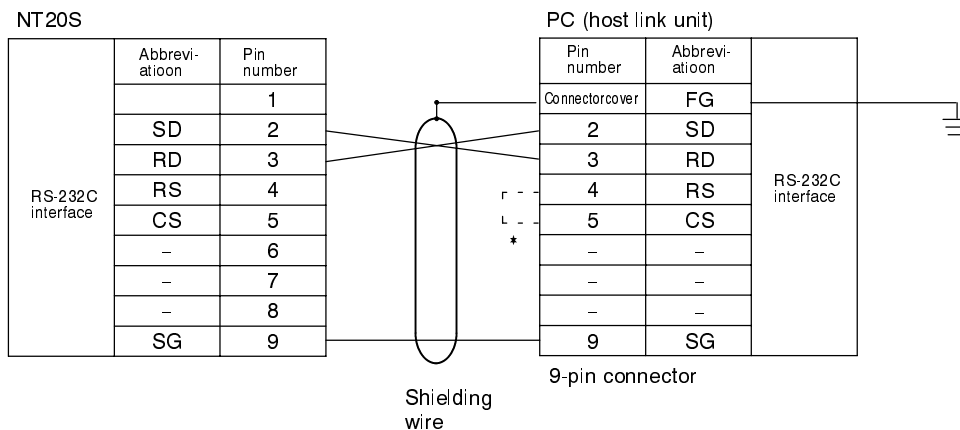

Connecting an NT20S to an RS-232C/422A Converter Unit (NT-AL001)

Connecting an RS-232C/422A converter unit enables the transmission distance to be made greater than 15 m (up to 500 m).

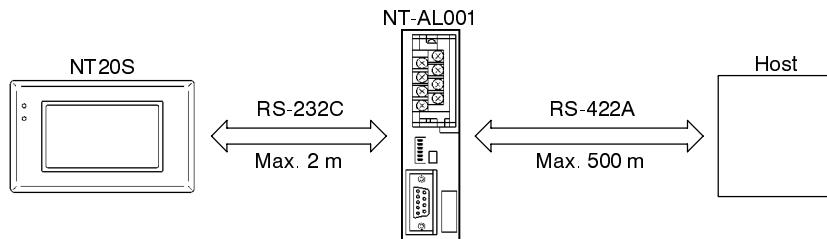

Reference: When connecting the C200HX/HG/HE and an RS-232C/RS-422A converter unit, use a converter unit whose lot number is 15Y5 or later. Converter units of lot numbers previous to 15Y5 cannot be connected.

NT-AL001 RS-232C connector specifications (9-pin type)

Electrical characteristics: Comply with EIA RS-232C
 Signal direction: Signal input and output is relative to the NT-AL001

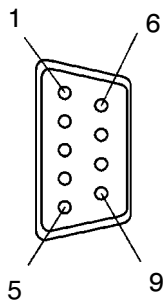

Connector Pin No.	Signal Name	Abbreviation	Signal Direction	
			Input	Output
Connector cover	Frame ground	FG	-	-
2	Send data	SD (TXD)		○
3	Receive data	RD (RXD)	○	
4	Request to send	RS (RTS)		○
5	Clear to send	CS (CTS)	○	
6	+5 V input	+5V	○	
9	Signal ground	SG (GND)	-	-

NT-AL001 RS-422A terminal block specifications

Connected terminal block: RS-422A terminal block (M3 screws)
 Electrical characteristics: Comply with EIA RS-422A
 Signal direction: Signal input and output direction is relative to the NT-AL001

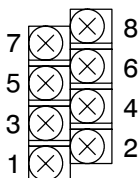

Terminal No.	Signal Name	Abbreviation	Signal Direction	
			Input	Output
1	Frame ground	FG	-	-
2	Signal ground	SG	-	-
3	Send data (+)	SDB		○
4	Send data (-)	SDA		○
5	Receive data (+)	RDB	○	
6	Receive data (-)	RDA	○	
7	Request to send (+)	CSB		○
8	Request to send (-)	CSA		○

Wiring method

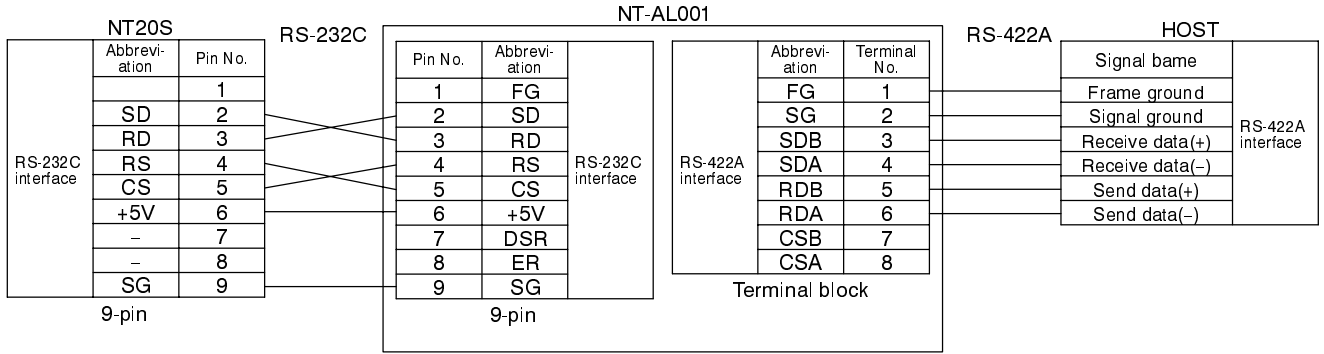

Preparing RS-232C Connector Cables

Prepare a connector cable to connect a NT20S to a Host separated by more than 5 m so that the standard connector cable cannot be used. The maximum cable length is 15 m.

Recommended Parts

Name	Model	Remarks
Connector (NT20S)	XM2A-0901	9-pin, manufactured by OMRON
Connector cover (NT20S)	XM2S-0911	9-pin, manufactured by OMRON
Cable	AWG28X5P IFVV-SB	Multicore cable, manufactured by Fujikura, Ltd.
	CO-MA-VV-SB 5PX28AWG	Multicore cable, manufactured by Hitachi Cable, Ltd.

On the other end of the cable use the type of connector and connector cover which matches the host computer connector type.

Connection For Host

The shielding wire of the cable is connected at the host side only, to the connector cover and pin No.1.

The figure below shows the wiring when RS/CS control is used. If RS/CS control is not used, short RS and CS at both the NT20S side and host side.

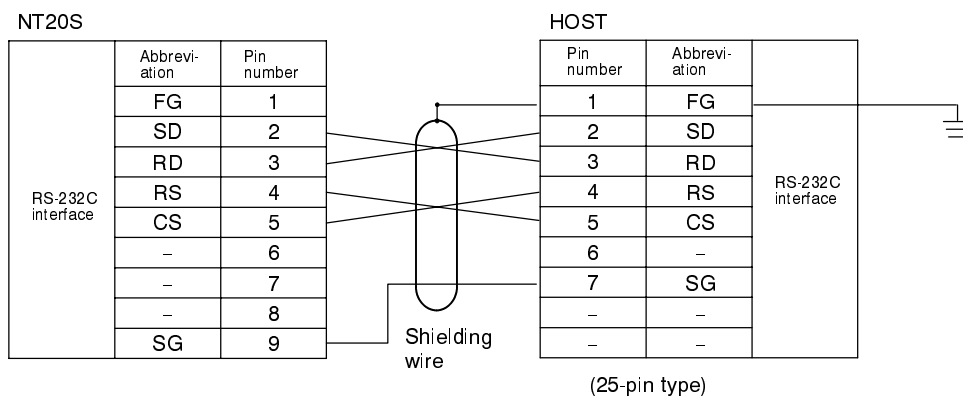

Making the Cable

The procedure to make up the cable is described below.

Refer to the following explanation when making an RS-422A cable also.

Cable Preparation

The preparation of the cable differs according to whether or not the shielding wire is to be connected to the FG.

- Cable with Shielding Wire Connected to FG

- (1) Cut the cable to the required length.
- (2) Remove the external vinyl insulation from the cable with a razor blade. Take care not to damage the shielding underneath.
- (3) Cut back the shielding wire with scissors.
- (4) Use wire strippers to strip the insulation from each wire.
- (5) Fold back the shielding wire.
- (6) Wrap aluminum foil tape around the folded-back shielding wire.

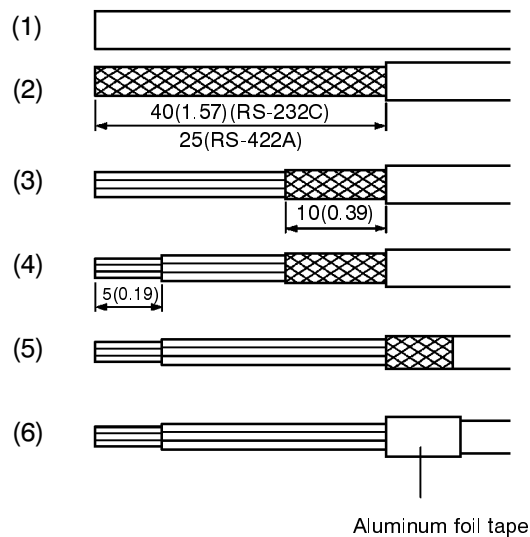

[Units: mm (in.)]

• Cable with Shielding Wire Not Connected to FG

- (1) Cut the cable to the required length.
- (2) Remove the external vinyl insulation from the cable with a razor blade. Take care not to damage the shielding underneath.
- (3) Cut back the shielding wire with scissors.
- (4) Use wire strippers to strip the insulation from each wire.
- (5) Wrap vinyl tape over the cut off end of the shielding wire.

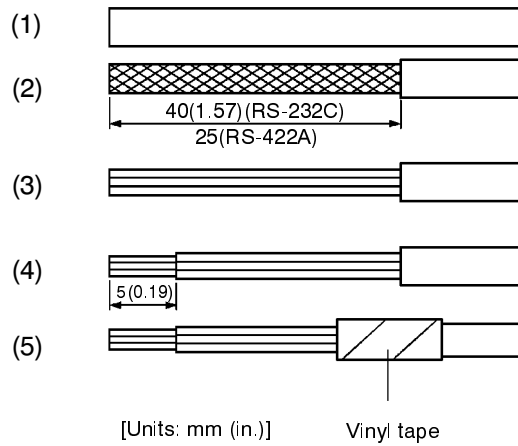

Soldering

- (1) Slide heat-shrink tube over each wire.
- (2) Pre-solder each wire and connector cable.
- (3) Solder each wire to the connector terminal.

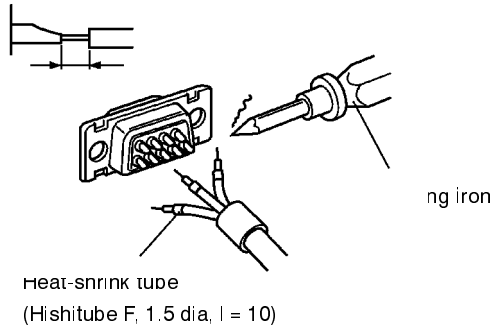

- (4) Push the heat-shrink tube over the soldered joint and heat the tube to shrink it in place.

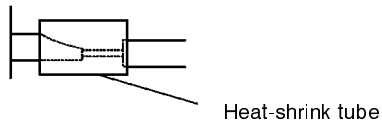

Connector Cover Assembly

Assemble the connector covers as shown in the diagram below.

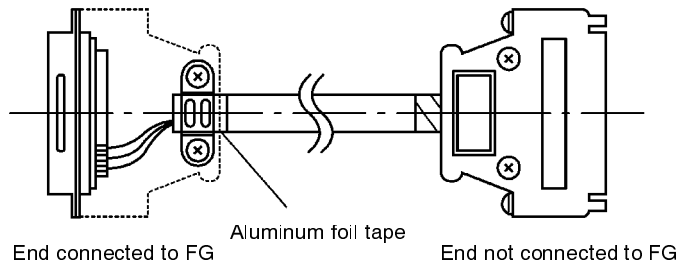

APPENDIX H

Making the Cable for Connection to the Support Tool

The wiring to be done depends on the type of RS-232C connector at the personal computer.

- For a 25-pin connector

1	FG
2	SD
3	RD
4	RS
5	CS
6	DR
7	SG
8	CD
20	ER

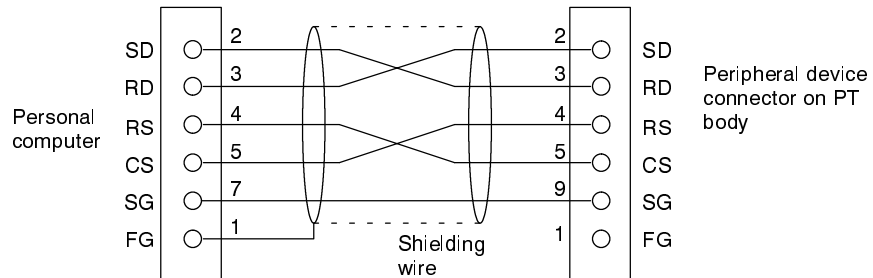

When making the connecting cable, use the following recommended parts.

Name	Model	Remarks
Connector	XM2A-2501	25-pin, manufactured by OMRON (personal computer side)
	XM2A-0901	9-pin, manufactured by OMRON (PT side)
Connector cover	XM2S-2511	25-pin, manufactured by OMRON (personal computer side)
	XM2S-0911	9-pin, manufactured by OMRON (PT side)
Cable	AWG28×5P IFVV-SB	Multiconductor shielded cable (FUJIKURA, Ltd.)
	CO-MA-VV-SB 5P×28AWG	Multiconductor shielded cable (HITACHI Cable, Ltd.)

- For a 9-pin connector

1	CD
2	RD
3	SD
4	DTR
5	SG
6	DR
7	RS
8	CS
9	

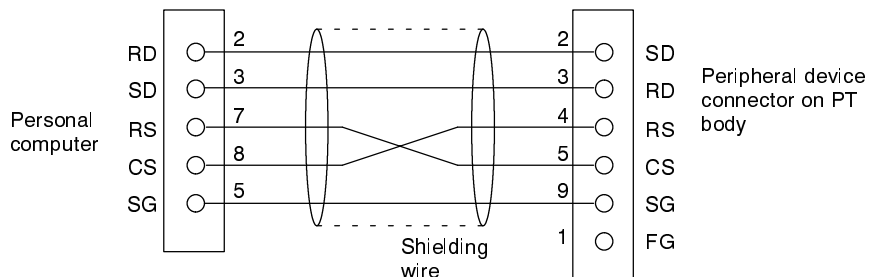

When making the connecting cable, use the following recommended parts.

Name	Model	Remarks
Connector	XM2D-0901	9-pin, manufactured by OMRON (personal computer side)
	XM2A-0901	9-pin, manufactured by OMRON (PT side)
Connector cover	XM2S-0911	9-pin, manufactured by OMRON (two)
Cable	AWG28×5P IFVV-SB	Multiconductor shielded cable (FUJIKURA, Ltd.)
	CO-MA-VV-SB 5P×28AWG	Multiconductor shielded cable (HITACHI Cable, Ltd.)

APPENDIX I

Connecting to an RS-232C/RS-422A Converter Unit (1:1)

By using an RS-232C/RS-422A converter unit (NT-AL001), RS-232C can be converted to RS-422A, allowing long-distance communication of up to 500 m.

Connection Method

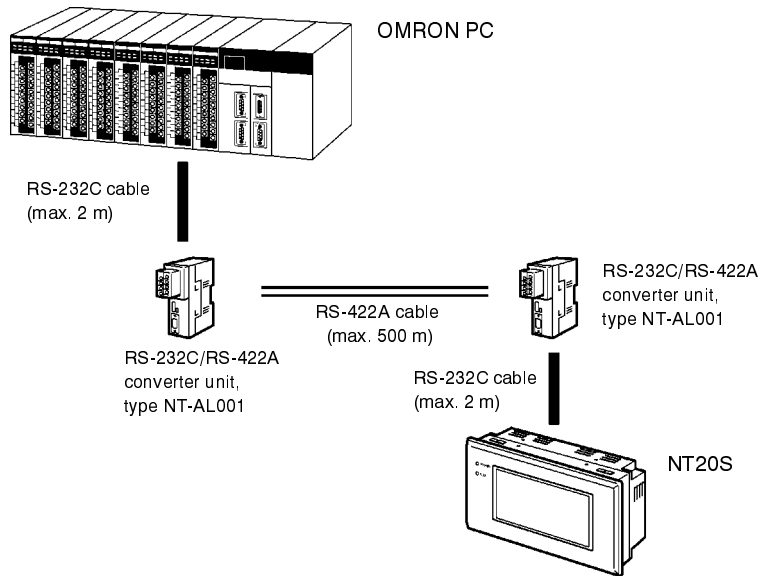

Wiring

- Wiring of RS-232C cable

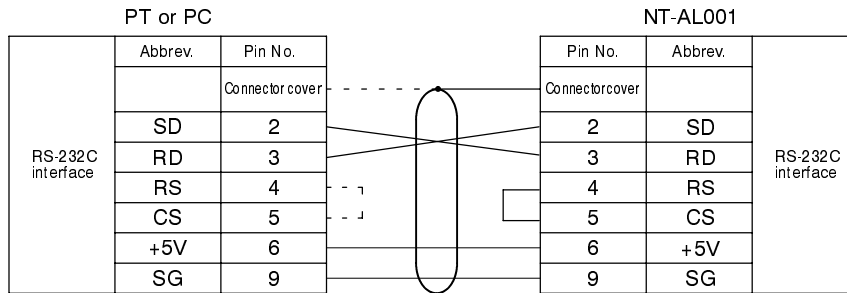

The pin numbers are the numbers at the NT20S. For the pin numbers at the PC, refer to the manual for the PC used.

Shielding wire

- - - Only connected at PC

• RS-422A Cable Wiring

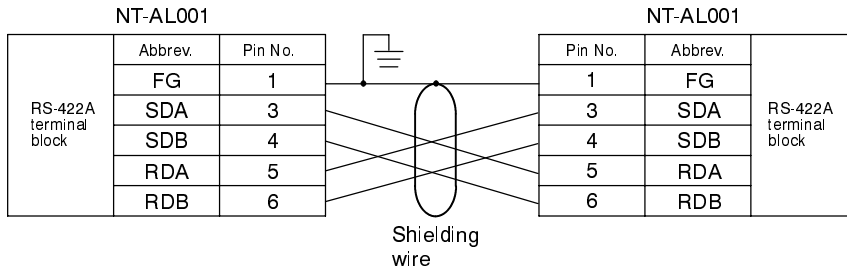

DIP Switch Settings at RS-232C/RS-422A Converter Unit

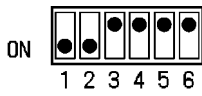

APPENDIX J

Model List

PT

Model	Specification
NT20S-ST121-EV3 NT20S-ST121B-EV3	Host link/NT link Blue mode display (Beige) (Black)
NT20S-ST161-EV3 NT20S-ST161B-EV3	Host link/NT link Monochrome mode display (Beige) (Black)
NT20S-ST122-V1 NT20S-ST122B-V1	C200H direct communication (Beige) (Black)
NT20S-ST128 NT20S-ST128B	RS-232C Blue mode display (Beige) (Black)
NT20S-ST168 NT20S-ST168B	RS-232C Monochrome mode display (Beige) (Black)

Host Link Unit

Model	Specification	Applicable PC
C120-LK201-V1	<ul style="list-style-type: none"> Features a connector for RS-232C connections Type mounted to a CPU 	C-series C120 C200H C500(F) C1000H C2000(H)
C200H-LK201(-V1)	<ul style="list-style-type: none"> Features a connector for RS-232C connections Type mounted to C200H base 	C-series C200H(S)/HE/HG/HX
C500-LK201-V1	Features a connector for RS-232C/RS-422A connections (switchable type).	C-series C500(F) C1000H C2000(H)
C500-LK203	Type mounted to C500 base	
CV500-LK201	<ul style="list-style-type: none"> Features a connector for RS-232C connections and a connector for RS-232C/RS422A connections (switchable type). Type mounted to base for CVM1/CV use. 	CVM1/CV-series CV500 CV1000 CV2000 CVM1

CPU (For Connection Via a Host Link)

Model	Specification	PC Type
C20H/C28H/C40H/C60H	Features a 9-pin connector for RS-232C connections	C-series C20H C28H C40H C60H
CPM1-10CDR-□ CPM1-20CDR-□ CPM1-30CDR-□	Connect an RS-232C adapter to the peripheral port.	C-series CPM1
CQM1-CPU21-E CQM1-CPU41-E CQM1-CPU42-E CQM1-CPU43-E CQM1-CPU44-E	Features a 9-pin connector for RS-232C connections	C-series CQM1
C200HS-CPU21-E C200HS-CPU23-E C200HS-CPU31-E C200HS-CPU33-E	Features a connector for RS-232C connections (selectable/9-pin)	C200HS
C200HE-CPU32-E(*) C200HE-CPU42-E	Features a connector for RS-232C connections (selectable/9-pin)	C-series C200HE
C200HG-CPU33-E(*) C200HG-CPU43-E C200HG-CPU53-E(*) C200HG-CPU63-E	Features a connector for RS-232C connections (selectable/9-pin)	C-series C200HG
C200HX-CPU34-E(*) C200HX-CPU44-E C200HX-CPU54-E(*) C200HX-CPU64-E	Features a connector for RS-232C connections (selectable/9-pin)	C-series C200HX
CV500-CPU01-EV1 CV1000-CPU01-EV1 CV2000-CPU01-EV1 CVM1-CPU01-EV1 CVM1-CPU11-EV1 CVM1-CPU21-EV1	Features a connector for RS-232C connections (selectable/9-pin)	CVM1/CV-series CV500 CV1000 CV2000 CVM1

Note: For CPU units marked (*), a communications board is required.

CPUs (For Connection Via an NT Link (1:1))

Model	Specification	PC Type
CPM1-10CDR-□ CPM1-20CDR-□ CPM1-30CDR-□	Connect an RS-232C adapter to the peripheral port.	C-series CPM1
CQM1-CPU41-E CQM1-CPU42-E CQM1-CPU43-E CQM1-CPU44-E	Features a 9-pin connector for RS-232C connections	C-series CQM1
C200HS-CPU21-E C200HS-CPU23-E C200HS-CPU31-E C200HS-CPU33-E	Features a 9-pin connector for RS-232C connections	C200HS
C200HE-CPU32-E(*) C200HE-CPU42-E	Features a connector for RS-232C connections (selectable/9-pin)	C-series C200HE
C200HG-CPU33-E(*) C200HG-CPU43-E C200HG-CPU53-E(*) C200HG-CPU63-E	Features a connector for RS-232C connections (selectable/9-pin)	C-series C200HG
C200HX-CPU34-E(*) C200HX-CPU44-E C200HX-CPU54-E(*) C200HX-CPU64-E	Features a connector for RS-232C connections (selectable/9-pin)	C-series C200HX
CV500-CPU01-V1-EV1 CV1000-CPU01-V1-EV1 CV2000-CPU01-V1-EV1 CVM1-CPU01-V1-EV□ CVM1-CPU11-V1-EV□ CVM1-CPU21-EV□	Features a 9-pin connector for RS-232C connections	CV500 CV1000 CV2000 CVM1-series

Note: For CPU units marked (*), a communications board is required.

CPUs (For Connection Via an NT Link (1:N))

Model	Specification	PC Type
C200HE-CPU32-E(*) C200HE-CPU42-E	Features a connector for RS-232C connections (selectable/9-pin)	C-series C200HE
C200HG-CPU33-E(*) C200HG-CPU43-E C200HG-CPU53-E(*) C200HG-CPU63-E	Features a connector for RS-232C connections (selectable/9-pin)	C-series C200HG
C200HX-CPU34-E(*) C200HX-CPU44-E C200HX-CPU54-E(*) C200HX-CPU64-E	Features a connector for RS-232C connections (selectable/9-pin)	C-series C200HX

Note: For CPU units marked (*), a communications board is required.

CPU Unit (Connection by C200H Direct Communication)

Model	Product Name
C20H-C□DR-DE-V1 C20H-C□DT-DE-V1	C20H
C28H-C□DR-DE-V1 C28H-C□DT-DE-V1	C28H
C40H-C□DR-DE-V1 C40H-C□DT-DE-V1	C40H
C60H-C□DR-DE-V1 C60H-C□DT-DE-V1	C60H
C200H-CPU01-E C200H-CPU03-E C200H-CPU11-E C200H-CPU21-E C200H-CPU23-E C200H-CPU31-E	C200H
C200HS-CPU01-E C200HS-CPU03-E C200HS-CPU21-E C200HS-CPU23-E C200HS-CPU31-E C200HS-CPU33-E	C200HS
C200HE-CPU11-E C200HE-CPU32-E C200HE-CPU42-E	C200HE
C200HG-CPU33-E C200HG-CPU43-E C200HG-CPU53-E C200HG-CPU63-E	C200HG
C200HX-CPU34-E C200HX-CPU44-E C200HX-CPU54-E C200HX-CPU64-E	C200HX

RS-232C/RS-422A Converter Unit

Model	Specification
NT-AL001	RS-232C : 9-pin connector RS-422A : 8-pin terminal block

RS-232C Adapter

Model	Specification
CPM1-CIF01	Connect the RS-232C port of the NT20S and the peripheral port of the CPM1.

Related Parts and Equipment for PT

Name	Model	Remarks
Support Tool	NT-ZA3AT-EV2	3.5 inch FD for NT Series
Options	NT20S-CFL01	Replaceable backlight
	NT20M-KBA04	Reflection-suppressing protective sheet

Parts Used for Connection

Cables with connectors

Model	Cable Length	Applicable Units	Communication Method	
XW2Z-200S	2 m	Host link units with 25-pin connectors	Host link	
XW2Z-500S	5 m			
XW2Z-200T	2 m	Host link units and CPU units with 9-pin connectors	Host link, NT link (1 to 1)	
XW2Z-500T	5m			
C200H-CN311	30 cm	C200H, C200HS, C200HX/HG/HE	C200H direct communication	
NT20M-CNP711 C200H-CN711	70 cm			
NT20M-CNP221 C200H-CN221	2 m			
NT20M-CNP521 C200H-CN521	5 m			
NT20M-CNP131 C200H-CN131	10 m			
C20H-CN312	30 cm			
NT20M-CNP712 C20H-CN712	70 cm			
NT20M-CNP222 C20H-CN222	2 m			
				C□□H

Connecting cables (for host link, NT link, RS-232C)

Model	Specification
AWG28×5P IFVV-SB	Multiconductor shielded cable (FUJIKURA, Ltd.)
CO-MA-VV-SB 5P×28AWG	Multiconductor shielded cable (HITACHI Cable, Ltd.)

Applicable connectors (for host link, NT link, RS-232C)

Name	Model	Remark
Connector	XM2A-2501	25-pin, manufactured by OMRON
	XM2A-0901	9-pin (Plug), manufactured by OMRON
	DB-25P	25-pin, manufactured by JAE
Connector cover	XM2S-2511	25-pin, manufactured by OMRON
	XM2S-0911	9-pin, manufactured by OMRON
	DB-C2-J9	25-pin, manufactured by JAE

APPENDIX K

Option List

Replaceable Backlight ... NT20S-CFL01

This is a backlight for replacement purposes.

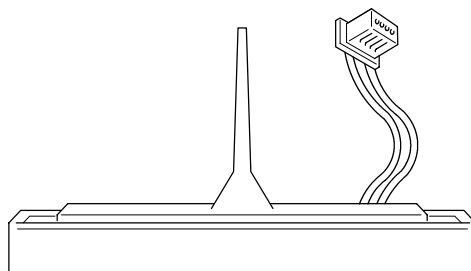

Note: The disposal of used backlights may be regulated by national or local authorities. Dispose of them in accordance with the laws and regulations of the relevant country and local authority.

Reflection-Suppressing Protective Sheet ... NT20M-KBA04

Stuck to the display to prevent it from being soiled. The entire sheet is colorless and transparent.

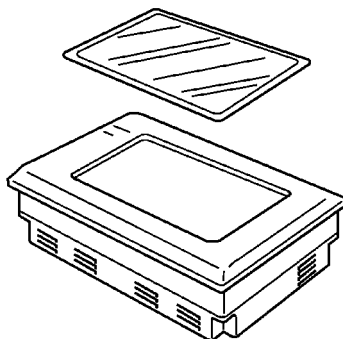

Chemical-resistant Cover .. Type NT20S-KBA01

Covers the front panel and protects it from chemical agents. The entire sheet is milky white and made of silicone rubber.

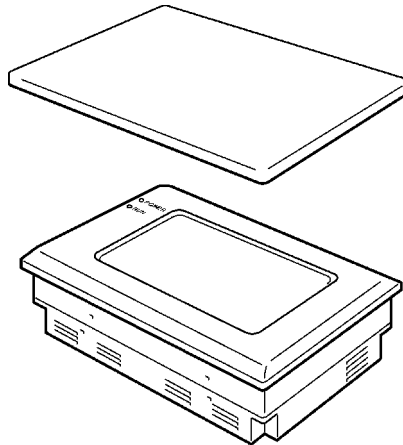

The protection the cover affords is summarized below.

Protects Against	Does Not Protect Against
Boric acid	Hexane
Sulfuric acid	Lubricating oils
Nitric acid	Benzene
Ammonia gas	Butane
Carbon dioxide	Carbonic acid
Phenol	Chlorinated solvents
Glycerin	Napthalene
Ammonia water	Soya oil
Calcium chloride	Toluene
Developing fluid ("hypo")	
Acetaldehyde	
Lard	

For information on protection against chemical agents not included in the table above, please ask OMRON. (If it is a chemical agent to which silicone rubber is recognized to be resistant, the cover can be used with confidence even if that chemical agent is not listed in the "Protects Against" column above.)

- Reference:**
- This cover does not afford protection against all chemical agents.
 - Since the cover is milky white, it reduces the clarity of the display a little.
 - This cover is intended to be affixed to the display in order to provide protection against chemical agents. It will not provide protection against chemical agents that enter through the installation panel or through the gap between the cover and the display.

APPENDIX L

PC Memory Map

OMRON C-Series Memory Map

Area		IR Area	HR Area	AR Area	Link Relay Area	Timer/Counter Area	DM Area
Ladder type	C20H C28H C40H C60H	0000 to 0255	0000 to 0099	0000 to 0027	0000 to 0063	0000 to 0511	0000 to 1999
	C120	0000 to 0063	0000 to 0031			0000 to 0127	0000 to 0051
	C200H	0000 to 0255	0000 to 0099	0000 to 0027	0000 to 0063	0000 to 0511	0000 to 1999
	C200HS C200HE C200HG C200HX	0000 to 0511	0000 to 0099	0000 to 0027	0000 to 0063	0000 to 0511	0000 to 6655 0000 to 9999
	C500	0000 to 0063	0000 to 0031		0000 to 0031	0000 to 0127	0000 to 0511
	C1000H						0000 to 4095
	C2000(H) CQM1	0000 to 0255	0000 to 0099	0000 to 0027	0000 to 0063	0000 to 0051	0000 to 6655
	CPM1	0000 to 0019 0200 to 0255	0000 to 0019	0000 to 0015	0000 to 0015	0000 to 0127	0000 to 1023 6144 to 6655
Flow type	C500F	0000 to 0063	0000 to 0031		0000 to 0031	0000 to 0127	0000 to 0511
	C1000HF	0000 to 0255	0000 to 0099	0000 to 0027	0000 to 0063	0000 to 0511	0000 to 4095

OMRON CV-Series Memory Map

Area	IR Area	HR Area (*1)	AR Area	Link Relay Area	Timer/Counter Area	DM Area
CV500 CVM1-CPU01(-V□)	0000 to 2555		0000 to 0511		0000 to 0511	0000 to 8191
CV1000 CVM1-CPU011(-V□) CV2000 CVM1-CPU21(-V□)	0000 to 2555		0000 to 0511		0000 to 1023	0000 to 9999 (*2)

(*1) Included in the IR area in the case of CVM1/CV-series PCs.

(*2) This is the area that can be used with an NT20S. The DM area itself occupies the range 00000 to 24575.

APPENDIX M Special Characters

English Character Codes

Pin 2 of SW2 must be ON to enable English language messages to use the following codes.

Example: Hex code is represented by 30, decimal code by 48, and character by 0.

30	0
48	

Code 20 and 32 in the table represents a space, as indicated by "SP".

Hex Digits 1st → 2nd ↓	2-		3-		4-		5-		6-		7-		8-		9-	
-0	20	SP	30	0	40	@	50	P	60	'	70	p	80	Ç	90	É
	32		48		64		80		96		112		128		144	
-1	21	!	31	1	41	A	51	Q	61	a	71	q	81	ü	91	æ
	33		49		65		81		97		113		129		145	
-2	22	"	32	2	42	B	52	R	62	b	72	r	82	é	92	Æ
	34		50		66		82		98		114		130		146	
-3	23	#	33	3	43	C	53	S	63	c	73	s	83	â	93	ô
	35		51		67		83		99		115		131		147	
-4	24	\$	34	4	44	D	54	T	64	d	74	t	84	ä	94	ö
	36		52		68		84		100		116		132		148	
-5	25	%	35	5	45	E	55	U	65	e	75	u	85	à	95	ò
	37		53		69		85		101		117		133		149	
-6	26	&	36	6	46	F	56	V	66	f	76	v	86	å	96	û
	38		54		70		86		102		118		134		150	
-7	27	'	37	7	47	G	57	W	67	g	77	w	87	ç	97	ù
	39		55		71		87		103		119		135		151	
-8	28	(38	8	48	H	58	X	68	h	78	x	88	ê	98	ÿ
	40		56		72		88		104		120		136		152	
-9	29)	39	9	49	I	59	Y	69	i	79	y	89	ë	99	Ö
	41		57		73		89		105		121		137		153	
-A	2A	*	3A	:	4A	J	5A	Z	6A	j	7A	z	8A	è	9A	Ü
	42		58		74		90		106		122		138		154	
-B	2B	+	3B	;	4B	K	5B	[6B	k	7B	{	8B	ï	9B	ç
	43		59		75		91		107		123		139		155	
-C	2C	,	3C	<	4C	L	5C	\	6C	l	7C		8C	î	9C	£
	44		60		76		92		108		124		140		156	
-D	2D	-	3D	=	4D	M	5D]	6D	m	7D	}	8D	ì	9D	¥
	45		61		77		93		109		125		141		157	
-E	2E	.	3E	>	4E	N	5E	^	6E	n	7E	~	8E	Ä	9E	Pt
	46		62		78		94		110		126		142		158	
-F	2F	/	3F	?	4F	O	5F	_	6F	o	7F	◊	8F	Å	9F	f
	47		63		79		95		111		127		143		159	

Hex Digits 1st → 2nd ↓	A-		B-		C-		D-		E-		F-	
-0	A0	á	B0	⋮	C0	└	D0	⊥	E0	α	F0	≡
	160		176	⋮	192	└	208	⊥	224		240	
-1	A1	í	B1	■	C1	└	D1	⊥	E1	β	F1	±
	161		177	■	193	└	209	⊥	225		241	
-2	A2	ó	B2	⋮	C2	└	D2	⊥	E2	Γ	F2	≥
	162		178	⋮	194	└	210	⊥	226		242	
-3	A3	ú	B3	└	C3	└	D3	⊥	E3	π	F3	≤
	163		179	└	195	└	211	⊥	227		243	
-4	A4	ñ	B4	└	C4	—	D4	⊥	E4	Σ	F4	∫
	164		180	└	196	—	212	⊥	228		244	
-5	A5	Ñ	B5	≡	C5	+	D5	F	E5	σ	F5	J
	165		181	≡	197	+	213	F	229		245	
-6	A6	á	B6	⊥	C6	≡	D6	⊥	E6	μ	F6	÷
	166		182	⊥	198	≡	214	⊥	230		246	
-7	A7	ó	B7	⊥	C7	⊥	D7	⊥	E7	τ	F7	≈
	167		183	⊥	199	⊥	215	⊥	231		247	
-8	A8	í	B8	└	C8	⊥	D8	≡	E8	Φ	F8	°
	168		184	└	200	⊥	216	≡	232		248	
-9	A9	└	B9	≡	C9	⊥	D9	└	E9	Θ	F9	·
	169		185	≡	201	⊥	217	└	233		249	
-A	AA	└	BA	⊥	CA	⊥	DA	└	EA	Ω	FA	•
	170		186	⊥	202	⊥	218	└	234		250	
-B	AB	1/2	BB	└	CB	⊥	DB	■	EB	δ	FB	√
	171		187	└	203	⊥	219	■	235		251	
-C	AC	1/4	BC	└	CC	⊥	DC	■	EC	∞	FC	n
	172		188	└	204	⊥	220	■	236		252	
-D	AD	i	BD	⊥	CD	≡	DD	■	ED	∅	FD	2
	173		189	⊥	205	≡	221	■	237		253	
-E	AE	«	BE	≡	CE	⊥	DE	■	EE	ε	FE	■
	174		190	≡	206	⊥	222	■	238		254	
-F	AF	»	BF	└	CF	⊥	DF	■	EF	∩	FF	* 1
	175		191	└	207	⊥	223	■	239		255	

* 1: Used as the prefix for mark data codes (2 bytes).

Revision History

A manual revision code appears as a suffix to the catalog number on the front cover of the manual.

Cat. No. V020-E1-4

↑
Revision code

The following table outlines the changes made to the manual during each revision. Page numbers refer to the previous version.

Revision code	Date	Revised content
1	September 1994	Original production
2	June 1995	Overall revision by addition of a new model
3	May 1997	Overall revision by addition of a new model <ul style="list-style-type: none">• Revisions due to addition of NT link (1:N)• Revisions due to addition of new model (NT20S-ST16□), addition of an applicable PC (CDM1), addition of explanations, and correction of errors.
4	August 1997	Correction of errors

INDEX

A

Allocatable bits and words	152
Allocated bit	12
Allocated word	12
Alternate	181
Automatic reset	238
Automatic reset function	84

B

Backlight	193, 239
Backlight OFF function	94
Backlight attributes	125
Backlight mode	193
Bar graphs	129
Batch lighting	134
Baud rate	83
Before operating	19
Bit input attributes	125, 208
Bit touch switch	125
Bit touch switch method	208
Buzzer	193
Buzzer attribute	193
Buzzer control	215

C

C200H/C200HS	60
C200H direct communication	14, 58
CPU	42, 273
C□□H	61
Cables with connectors	275
Cannot be normally started	72
Cannot communicate	236

Caution	xii, xiii
Changing displayed numerals or character strings	169, 171, 174
Changing the contents of allocated words	169, 171, 174
Changing the lamp display status	179
Changing the status of allocated bits	183
Changing the system settings	67
Character-string	17
Character-string memory table	126, 168
Character specify size	217
Characters	9, 119, 126
Checking the LCD	103
Checking the LED	105
Checking the PT setting	107
Checking the buzzer	104
Checking the communications	100
Checking the screen memory	106
Checking the touch switches	99
Child screens	122, 123
Classification of screens	122
Clear screen	216
Comm. check	101, 102
Comm. type	75
Communication is automatically reset	84
Communication procedure	201
Comparison between NT20S and NT20M	7
Compatibility	5
Compatible PCs	32, 45, 49
Connecting cables	275
Connecting the NT20S	34, 46, 49
Connector	34
Connector cover	275
Connector specifications	257

- Connectors 275
- Content upgrade memory table 188
- Continuous buzzer 193
- Continuous screens 123, 140, 159, 161
- Continuous sound 93, 125
- Contrast control 23
- Control bits 181
- Controlling the NT20S status 154, 191
- Controlling the display elements 153
- Copy memory table 207
- Copy memory table setting 174
- Copy type 174, 175
- Copying the memory table 174
- Creating numeric keys 143
- Creating screen data 113
- Crimp terminals 30
- Currently displayed screen word 160, 161

D

- DIP-SW status 109
- DIP switch 24, 42
- DIP switch settings 109
- Data bits 83
- Data memory (DM) 178
- Data transmission in screen units 87
- Decimal fraction parts 146
- Determining the numeral memory table
number 188
- Determining touch switch status 183
- Difference between direct connection Ver. 4 and Ver. 5 8
- Difference between the NT20S-ST12□ and NT20S-ST16□ 8
- Direct conn. setting screen 115
- Direct connection 12

Direct information	237
Direct setting	113
Direct specification	163, 165, 169
Display elements	15
Display frame	137
Display specified screen	204
Draw circle	221
Draw polyline	221

E

ERR ON	94
EXIT	100
Edit screen	115
8-digit number input notify	212
8-digit write numeral memory table	206
End flashing display	219
End inverse display	218
End plates	149
Enlarged display	119
Error message when the NT20S is started	72

F

FA site	2
Factory setting	24
File list	114
File units	86
Flash memory	75
Flashing	133, 138
Flashing display	120, 127
Flow control	83
Frame	133
4-digit number input notify	212
4-digit write numeral memory table	206

Function restrictions depending on the support tool 255

G

Graph frame 130

Guide display 134, 138

H

Host I/F tool connector 23

Host communication conditions 63

Host link 12, 78

Host link method 32

Host link unit 35, 37, 271

I

I/O check 99

I/O connection cable 59

IP65 4, 28

Indirect specification 163, 165, 171

Init. Screen 73, 74

Initialization by using the DIP switch 89

Initialization by using the DIP switch
(Forced initialization) 74

Initialization by using the system menu 72

Initialization error 237

Initialization setting 164, 166

Initialize the screen data memory 87

Initializing 72

Initializing memory 72

Installation environment 251

Integer fraction parts 146

Intermittent buzzer 193

Intermittent sound 93, 125

Internal processing 252

Inverse display 138

K

Key press sound 91

L

LCD 251

LCD panel 94

LSS 41, 42, 43, 47

Lamp and touch switch display
(Bit specification) 210

Lamp and touch switch display
(Number specification) 210

Lamp and touch switch display status
enquiry 211

Lamp and touch switch display status
response 211

Lamp bit control 97

Lamps 9, 15, 133

Lid for backlight replacement 23

Lit 133, 138

M

Maintenance 68

Maintenance mode 71

Making up a connecting cable 256

Mark data 237

Marks 9, 119, 127

Memory error 107

Memory size 113

Memory switches 75

Menu tree 69

Momentary 181

Monitoring 16

More than one lamp can be lit in batch 134

N

NT-AL001 262

- NT20S 2
- NT20S has made a buzzer sound 72
- NT link 12, 13, 45, 78
- Names of parts 22
- 9-pin 34
- Normal display 218
- Normal screen 122
- Notes on the notification operation 182
- Nothing is displayed 236
- Notification of numbers to the PC 188
- Notify bit 181
- Notifying the NT20S status 156
- Notifying the PC 1
- Notifying the display elements 155
- Notifying the display screen 160
- Number of registration words 164, 166
- Numeral memory table 127, 167
- Numeral setting 123, 140
- Numeral setting attribute 125, 143
- Numeral setting strobe 188, 197
- Numeric key type 142
- Numeric keys 143
- Numeric values 9

O

- OMRON product references v
- 100% value 130
- Operating status 2, 197
- Operation 68
- Operation by operating commands 202
- Operation by terminal commands 202
- Operation commands 18
- Operation mode 68

Operation panel	28
Operations with the system menu	70
Order for writing	175
Overlapping screen	122, 140, 159, 161

P

PC	32, 45, 48
PC memory map	278
PC switch settings	36, 47
PC system setting	41, 42, 43, 47
POWER	105
POWER LED	236
PT	2, 271
PT operating status	196
PT setting	113
PT status	196
PT status control area	17, 154, 191
PT status notify area	17, 156
Page number display	123
Panel	2
Panel fittings	28
Parent screen	122, 123
Parity check	83
% display	130
% values	131
Peripheral tool	41, 42, 43, 47
Power input terminals	23, 29
Power to the computer is interrupted	89
Programmable terminal	2
+5V output	64

Q

QQ command	237
------------------	-----

R

- RS-232C/422A converter unit 262
- RS-232C I/F 102
- RS-232C cable 31
- RS/CS 83
- RUN 105
- RUN LED 236
- Reflection-suppressing protective sheet 276
- Related manuals and their contents xi
- Replaceable backlight 276
- Replacing the backlight 240
- Request screen number 204
- Reset 89, 181
- Reset switch 23
- Reverse 134
- Reverse and flashing display 120, 127
- Reverse display 120, 127
- Revision history 287
- Rotary switch 25

S

- Safety precautions xiv
- Screen 118
- Screen #0 236
- Screen No. 1 90
- Screen attributes 125
- Screen data 86, 237
- Screen data displayed on the NT20S 9
- Screen data memory 72
- Screen display 192
- Screen display control 215
- Screen list 115
- Screen number 118
- Screen number "0" 118

Screen number response	205
Screen switch setting	157
Screen switching	138
Screen switching strobe	158, 160, 196
Screen switching timing	158
Selecting communication speed	79
Selecting the host communication method	78
Selecting the items	71
Selecting the numeral setting area for data input	145
Set	181
Set cursor position	220
Set flashing display	219
Set inverse display	218
Setting	107
Setting a screen number for a touch switch	138
Setting a system key function for a touch switch	139
Setting error	237
Setting the buzzer	92
Setting the support tool	112
Setting the words of the character-string memory table	164
Setting the words of the numeral memory table	166
Sign display	130
Smoothing	119, 127
Specify character enlargement	217
Specify displayed characters	220
Standard	137
Start-up screen	118
Starting	67
Statuses of touch switches are changed	183
Stop bits	83

Support tool mode	95, 255
Support tools	3, 31, 86, 113
Switching predetermined values or character strings according to the situation	174
Switching the continuous screens	124
Switching the power ON/OFF when using C200H direct communication	62
Switching the screen display	157
Switching to the RUN mode	90
System	125
System key functions	139
System menu	68
System menu display permission	215

T

Terminal commands	18
3-D	137
Thumbwheel type	142
Timing	198
To stop the buzzer sound	92, 104
Tool I/F	101
Tool settings	113
Touch	71
Touch switch number output (from NT20S to host)	213
Touch switch # method	208
Touch switch bit output (from NT20S to host)	213
Touch switch disable	214
Touch switch enable	214
Touch switches	9, 16, 70, 136
Touch switches used to call the system menu	70
Transmission in file units	86
Transmit	68

Transmit mode 71, 88, 117

Transmitting screen data 87, 117

Transportation and storage 251

Turn ON the power 67

Types of notification operation 181

25-pin 34

U

Unit number 25

Unlit 133

Upgrading bar graphs 177

Upper/lower limit check 141

Used for the first time 72

User 125

Using numeric keys 145

Using the thumbwheel type 147

Using touch switches for notification to the
PC 181

W

Warning xv

Waterproof requirements 4

Wide angle of visibility 4, 251

Wiring 257, 264

Write character-string memory table 205

X

XON/XOFF 83

Z

Zero suppress 128

Revision History

NT-20S Programmable Terminal

Operation Manual

A manual revision code appears as a suffix to the catalog number on the front cover of the manual.

Cat. No. V020-E3-2
↑
Revision
code

The following table outlines the changes made to the manual during each revision. Page numbers refer to the previous version.

Revision code	Date	Revised content
V020-E1-1	September 1994	Original production
V020-E1-2	June 1995	Overall revision by addition of a new model
V020-E1-3	May 1997	Overall revision by addition of a new model <ul style="list-style-type: none"> • Revisions due to addition of NT link (1:N) • Revisions due to addition of new model (NT20S-ST16□)m addition of an applicable PC (CDM1), addition of explanations, and correction of errors.
V020-E1-4	August 1997	Correction of errors
V020-E3-2	May 1998	Revisions made to version V020-E1-4. Section 1-3, NT Link (1:N) Systems, replaced graphic. Changed Heading in Section 3-5.