

SKKD 40F, SKMD 40F

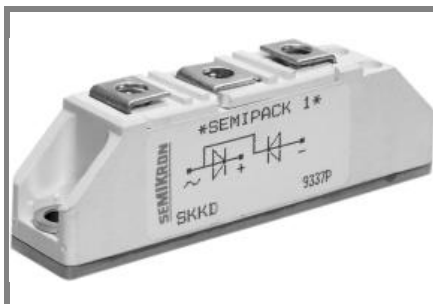

SEMIPACK[®] 1

Fast Diode Modules

SKKD 40F

SKMD 40F

Features

- Heat transfer through ceramic isolated metal baseplate
- Hard soldered joints for high reliability
- SKKD half bridge connection; SKMD centre tap connection, common cathode
- UL recognized, file no. E 63 532

Typical Applications*

- Self-commutated inverters
- DC choppers
- AC motor speed control
- Inductive heating
- Uninterruptible power supplies
- Electronic welders
- General power switching application

V_{RSM} V	V_{RRM} V	$I_{FRMS} = 110$ A (maximum value for continuous operation) $I_{FAV} = 40$ A (sin. 180°; 50Hz; $T_c = 80$ °C)	
400	400	SKKD 40F04	SKMD 40F04
600	600	SKKD 40F06	SKMD 40F06
800	800	SKKD 40F08	SKMD 40F08
1000	1000	SKKD 40F10	SKMD 40F10

Symbol	Conditions	Values	Units
I_{FAV}	sin. 180; $T_c = 85$ (100) °C	37 (25)	A
I_{FSM}	$T_{vj} = 25$ °C; 10 ms	1100	A
	$T_{vj} = 125$ °C; 10 ms	940	A
i^2t	$T_{vj} = 25$ °C; 8,3 ... 10 ms	6000	A ² s
	$T_{vj} = 125$ °C; 8,3 ... 10 ms	4400	A ² s
V_F	$T_{vj} = 25$ °C; $I_F = 150$ A	max. 2	V
$V_{(TO)}$	$T_{vj} = 125$ °C	max. 1,2	V
r_T	$T_{vj} = 125$ °C	max. 4	mΩ
I_{RD}	$T_{vj} = 25$ °C; $V_{RD} = V_{RRM}$	max. 0,5	mA
I_{RD}	$T_{vj} = 125$ °C; $V_{RD} = V_{RRM}$	max. 50	mA
Q_{rr}	$T_{vj} = 125$ °C; $I_F = 100$ A,	3	μC
I_{RM}	$-di/dt = 30$ A/μs, $V_R = 30$ V	10	A
t_{rr}		600	ns
E_{rr}		0,05	mJ
$R_{th(j-c)}$	per diode / per module	0,7 / 0,35	K/W
$R_{th(c-s)}$	per diode / per module	0,2 / 0,1	K/W
T_{vj}		- 40 ... + 125	°C
T_{stg}		- 40 ... + 125	°C
V_{isol}	a. c. 50 Hz; r.m.s.; 1 s / 1 min.	3600 / 3000	V~
M_s	to heatsink	5 ± 15 %	Nm
M_t	to terminals	3 ± 15%	Nm
a		5 * 9,81	m/s ²
m	approx.	120	g
Case	SKKD	A 10	
	SKMD	A 11	

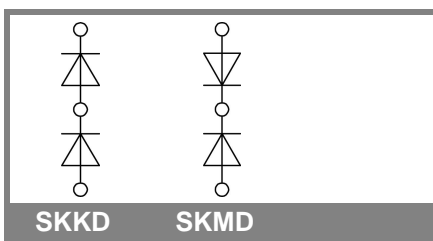

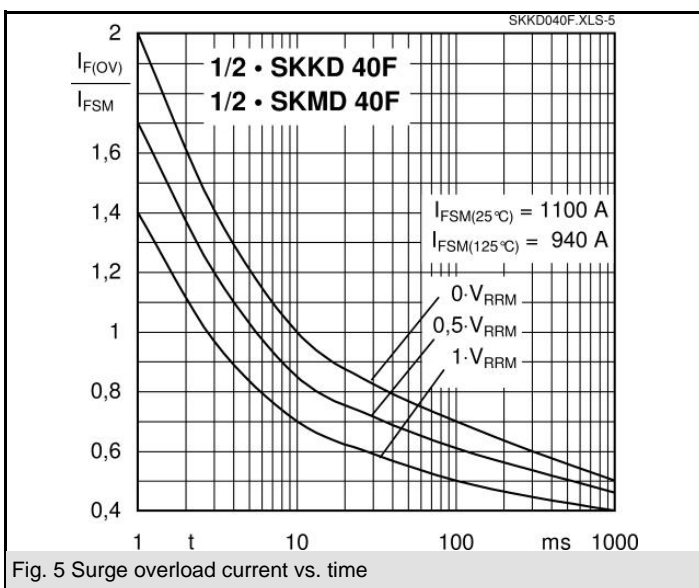
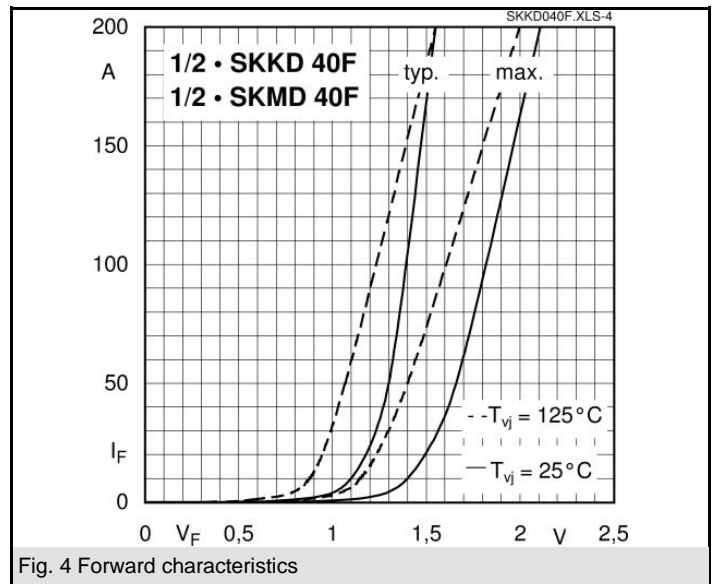
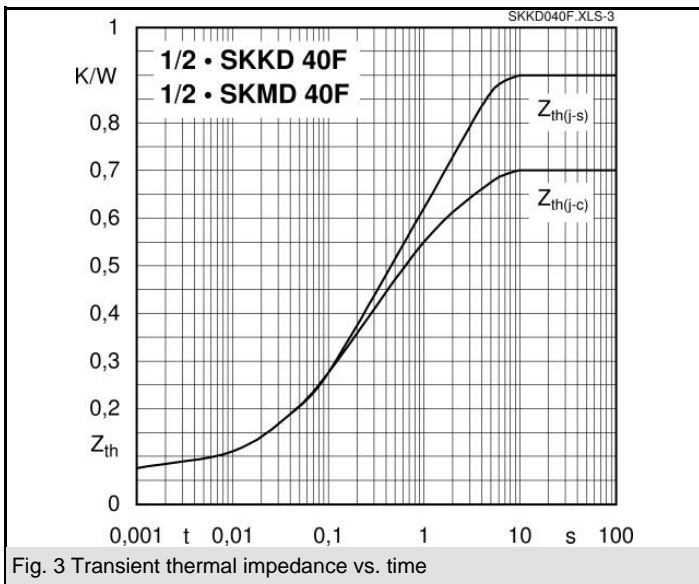
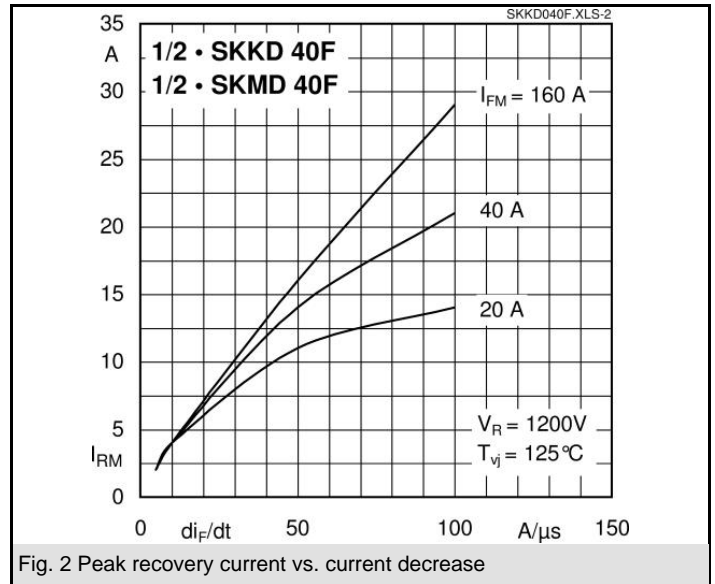
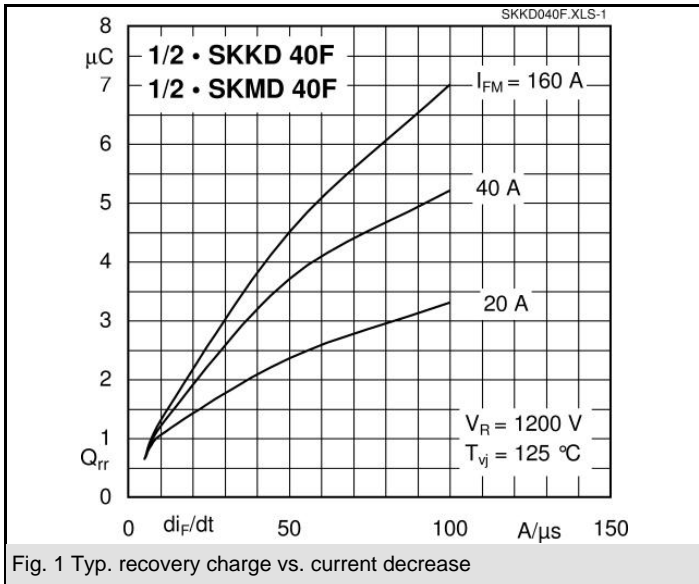

SKKD 40F, SKMD 40F

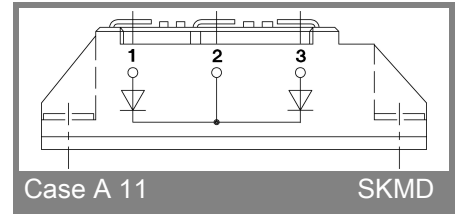
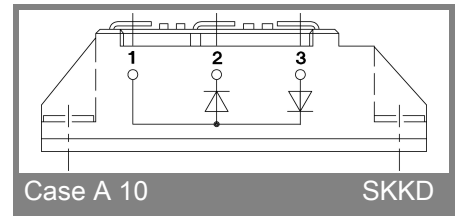
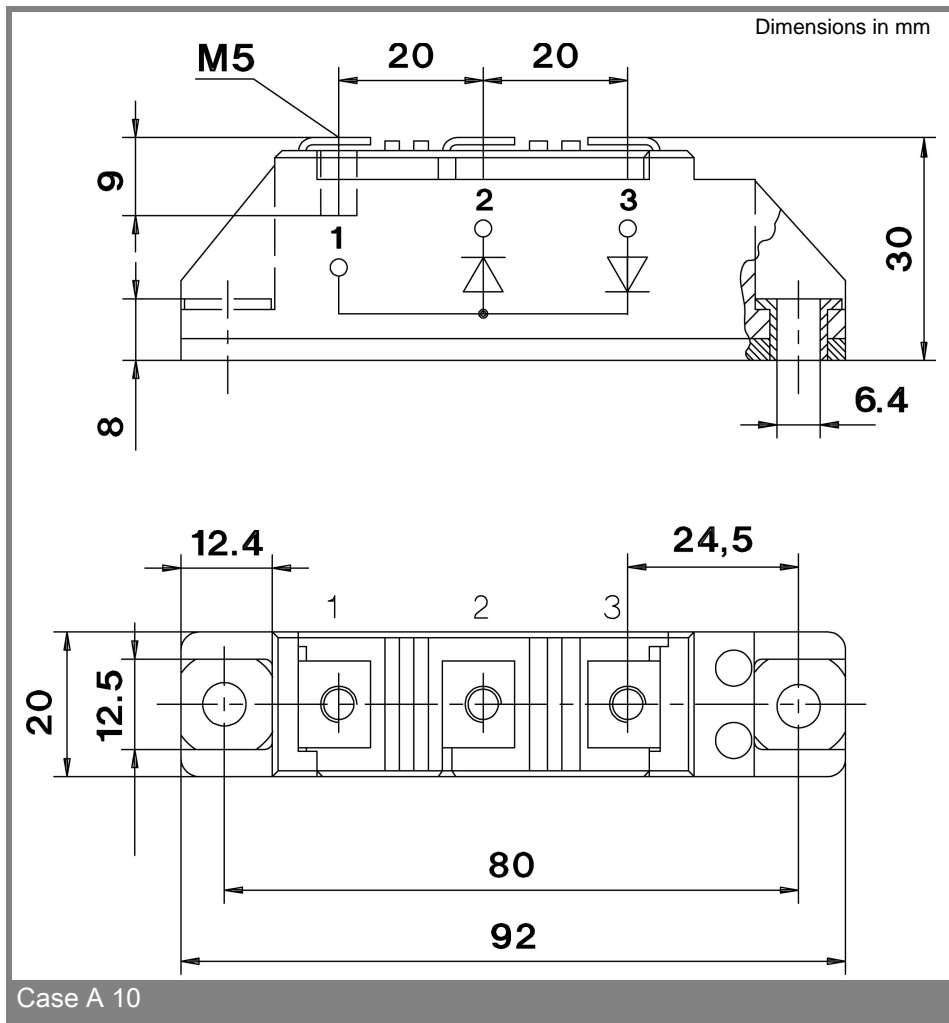

* The specifications of our components may not be considered as an assurance of component characteristics. Components have to be tested for the respective application. Adjustments may be necessary. The use of SEMIKRON products in life support appliances and systems is subject to prior specification and written approval by SEMIKRON. We therefore strongly recommend prior consultation of our staff.