

# SKKT 27, SKKT 27B, SKKH 27



**SEMIPACK® 1**

## Thyristor / Diode Modules

**SKKT 27**

**SKKT 27B**

**SKKH 27**

### Features

- Heat transfer through aluminium oxide ceramic isolated metal baseplate
- Hard soldered joints for high reliability
- UL recognized, file no. E 63 532

### Typical Applications\*

- DC motor control (e. g. for machine tools)
- AC motor soft starters
- Temperature control (e. g. for ovens, chemical processes)
- Professional light dimming (studios, theaters)

1) See the assembly instructions

$V_{RSM}$ V	$V_{RRM}, V_{DRM}$ V	$I_{TRMS} = 50$ A (maximum value for continuous operation) $I_{TAV} = 27$ A (sin. 180; $T_c = 82$ °C)		
900	800	SKKT 27/08E	SKKT 27B08E	SKKH 27/08E
1300	1200	SKKT 27/12E	SKKT 27B12E	SKKH 27/12E
1500	1400	SKKT 27/14E	SKKT 27B14E	SKKH 27/14E
1700	1600	SKKT 27/16E	SKKT 27B16E	SKKH 27/16E
1900	1800			SKKH 27/18E

Symbol	Conditions	Values	Units
$I_{TAV}$	sin. 180; $T_c = 85$ (100) °C;	25 (18)	A
$I_D$	P3/180; $T_a = 45$ °C; B2 / B6	38 / 50	A
	P3/180F; $T_a = 35$ °C; B2 / B6	60 / 77	A
$I_{RMS}$	P3/180; $T_a = 45$ °C; W1 / W3	52 / 3 x 37	A
$I_{TSM}$	$T_{vj} = 25$ °C; 10 ms	550	A
	$T_{vj} = 125$ °C; 10 ms	480	A
$i^2t$	$T_{vj} = 25$ °C; 8,3 ... 10 ms	1500	A <sup>2</sup> s
	$T_{vj} = 125$ °C; 8,3 ... 10 ms	1150	A <sup>2</sup> s
$V_T$	$T_{vj} = 25$ °C; $I_T = 75$ A	max. 1,8	V
$V_{T(TO)}$	$T_{vj} = 125$ °C	max. 0,9	V
$r_T$	$T_{vj} = 125$ °C	max. 12	mΩ
$I_{DD}; I_{RD}$	$T_{vj} = 125$ °C; $V_{RD} = V_{RRM}; V_{DD} = V_{DRM}$	max. 10	mA
$t_{gd}$	$T_{vj} = 25$ °C; $I_G = 1$ A; $di_G/dt = 1$ A/μs	1	μs
$t_{gr}$	$V_D = 0,67 * V_{DRM}$	1	μs
$(di/dt)_{cr}$	$T_{vj} = 125$ °C	max. 150	A/μs
$(dv/dt)_{cr}$	$T_{vj} = 125$ °C	max. 1000	V/μs
$t_q$	$T_{vj} = 125$ °C	80	μs
$I_H$	$T_{vj} = 25$ °C; typ. / max.	100 / 200	mA
$I_L$	$T_{vj} = 25$ °C; $R_G = 33$ Ω; typ. / max.	250 / 400	mA
$V_{GT}$	$T_{vj} = 25$ °C; d.c.	min. 3	V
$I_{GT}$	$T_{vj} = 25$ °C; d.c.	min. 150	mA
$V_{GD}$	$T_{vj} = 125$ °C; d.c.	max. 0,25	V
$I_{GD}$	$T_{vj} = 125$ °C; d.c.	max. 5	mA
$R_{th(j-c)}$	cont.; per thyristor / per module	0,9 / 0,45	K/W
$R_{th(j-c)}$	sin. 180; per thyristor / per module	0,95 / 0,48	K/W
$R_{th(j-c)}$	rec. 120; per thyristor / per module	1 / 0,5	K/W
$R_{th(c-s)}$	per thyristor / per module	0,2 / 0,1	K/W
$T_{vj}$		- 40 ... + 125	°C
$T_{stg}$		- 40 ... + 125	°C
$V_{isol}$	a. c. 50 Hz; r.m.s.; 1 s / 1 min.	3600 / 3000	V~
$M_s$	to heatsink	5 ± 15 % <sup>1)</sup>	Nm
$M_t$	to terminals	3 ± 15 %	Nm
$a$		5 * 9,81	m/s <sup>2</sup>
$m$	approx.	95	g
Case	SKKT	A 46	
	SKKT ...B	A 48	
	SKKH	A 47	



**SKKT**

**SKKH**

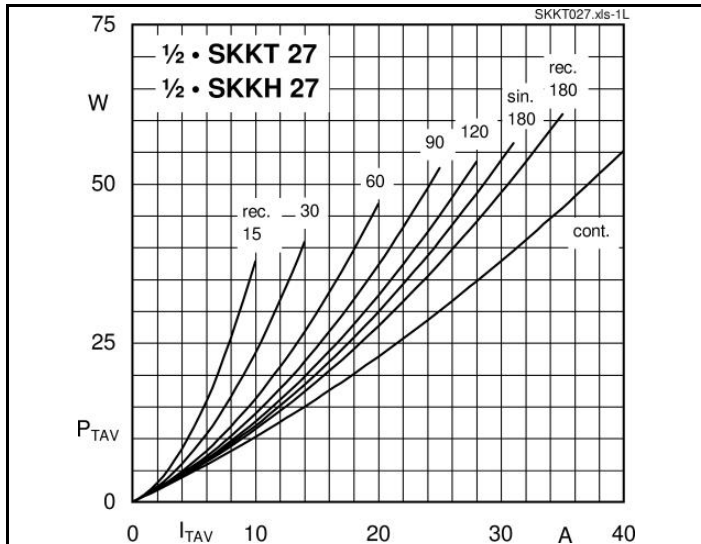

Fig. 1L Power dissipation per thyristor vs. on-state current

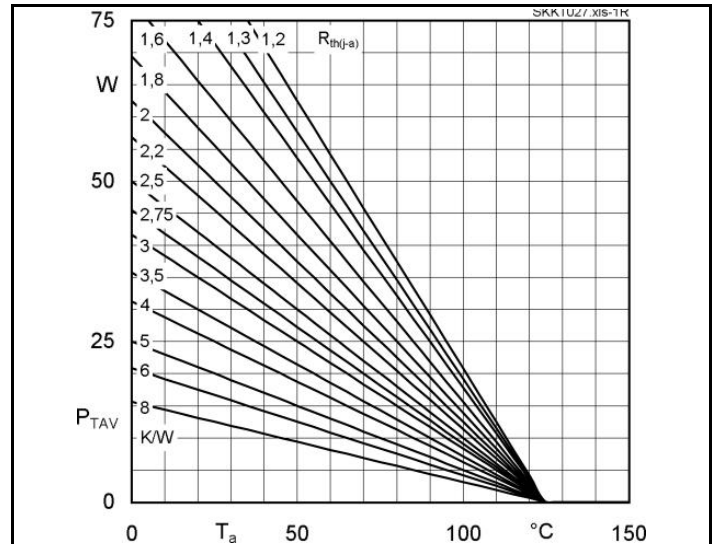

Fig. 1R Power dissipation per thyristor vs. ambient temp.

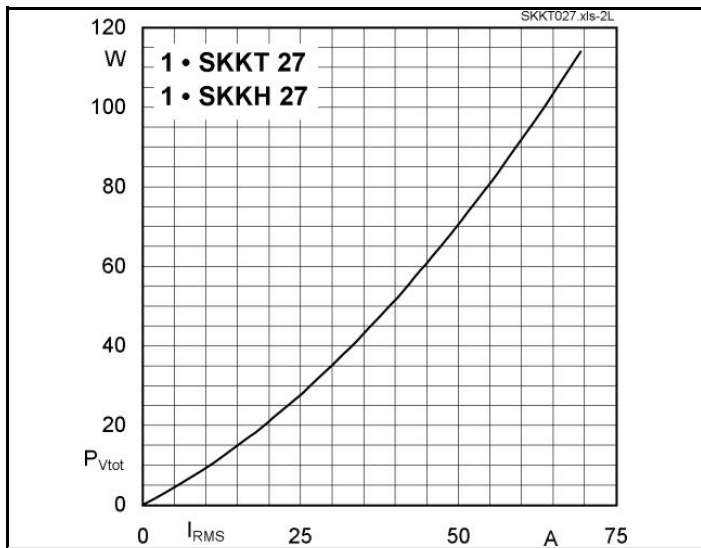

Fig. 2L Power dissipation per module vs. rms current

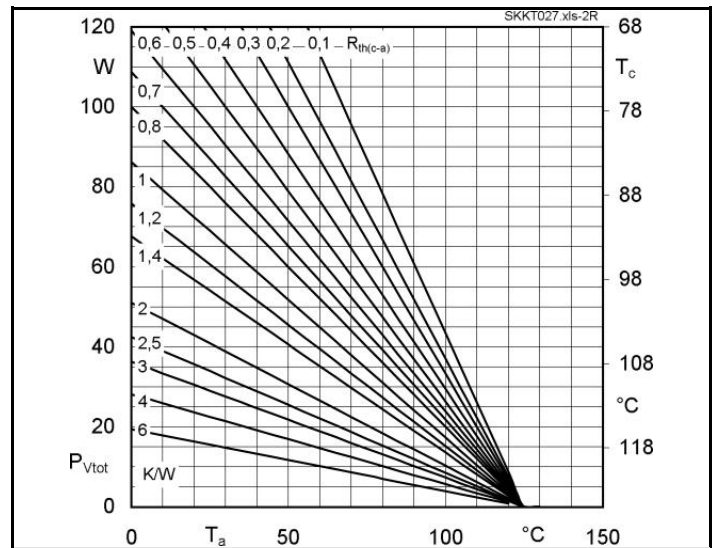

Fig. 2R Power dissipation per module vs. case temp.

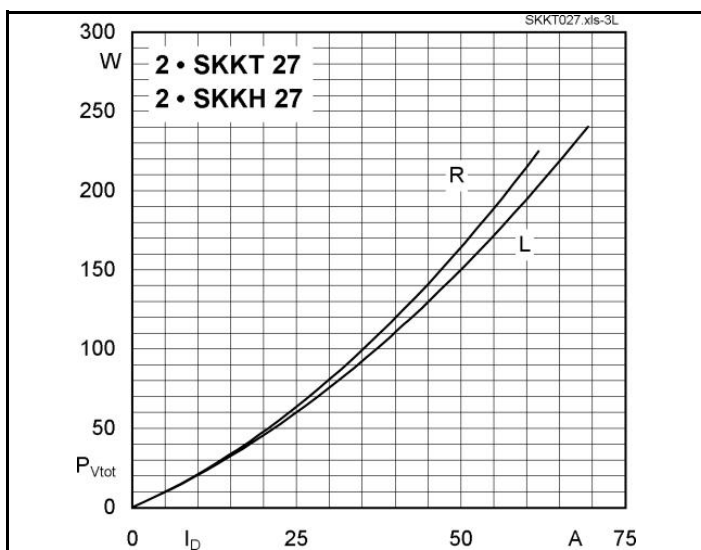

Fig. 3L Power dissipation of two modules vs. direct current

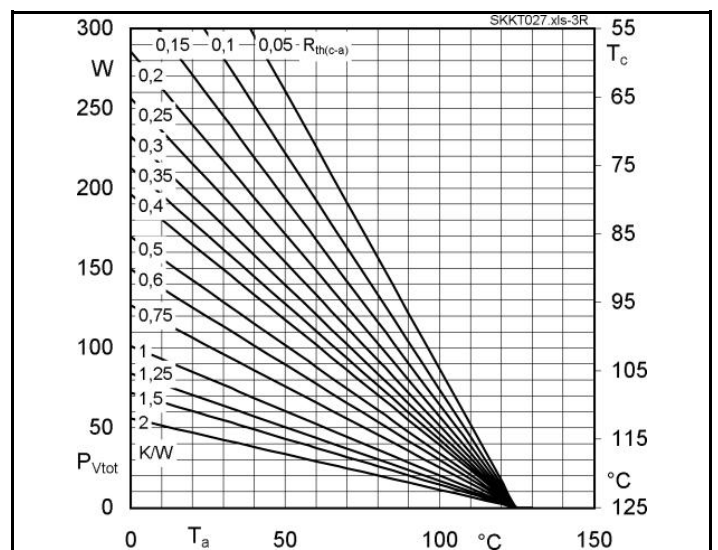
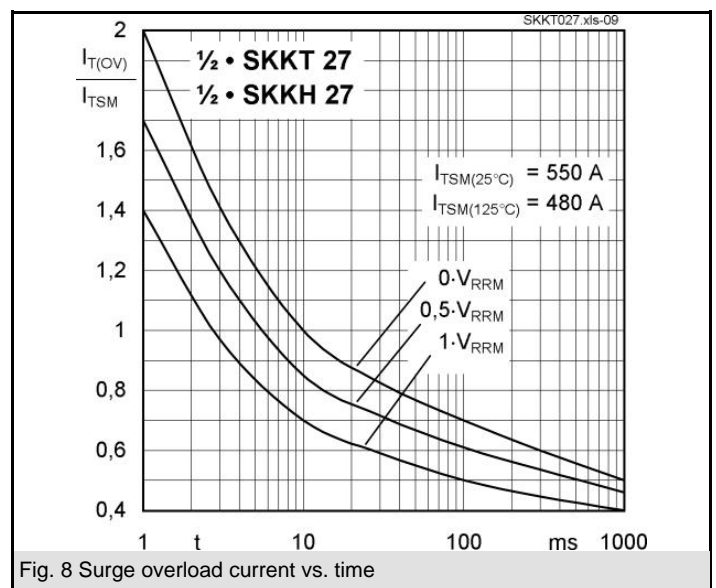
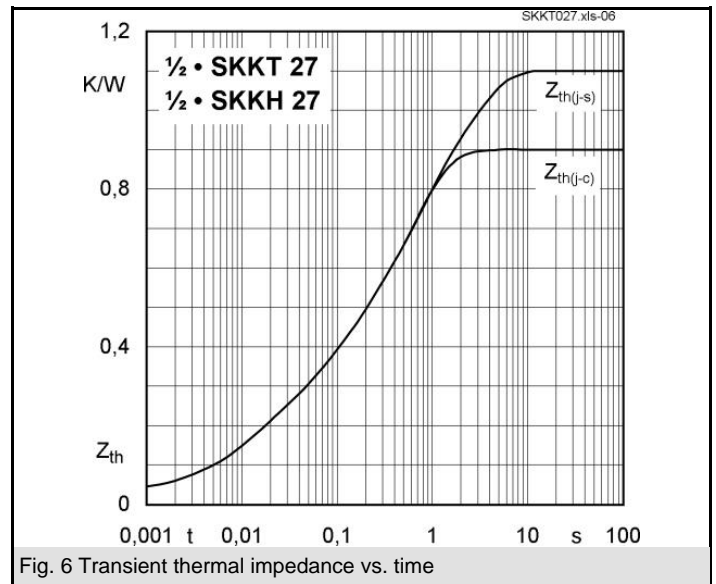
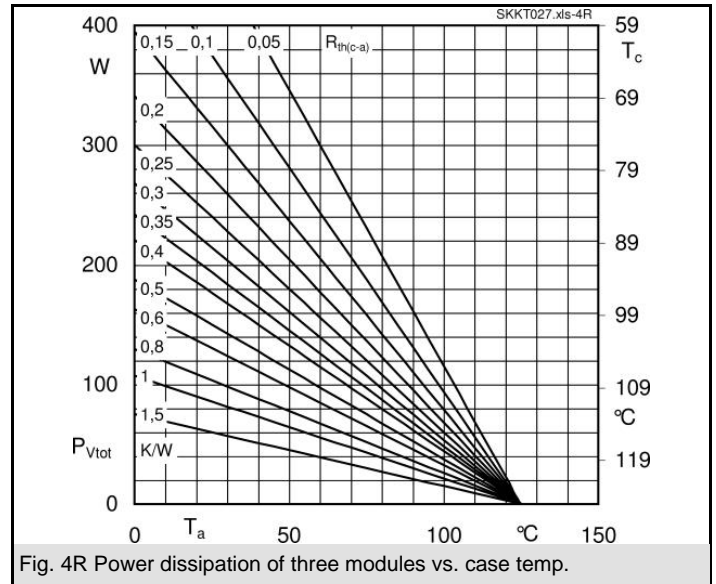

Fig. 3R Power dissipation of two modules vs. case temp.

# SKKT 27, SKKT 27B, SKKH 27



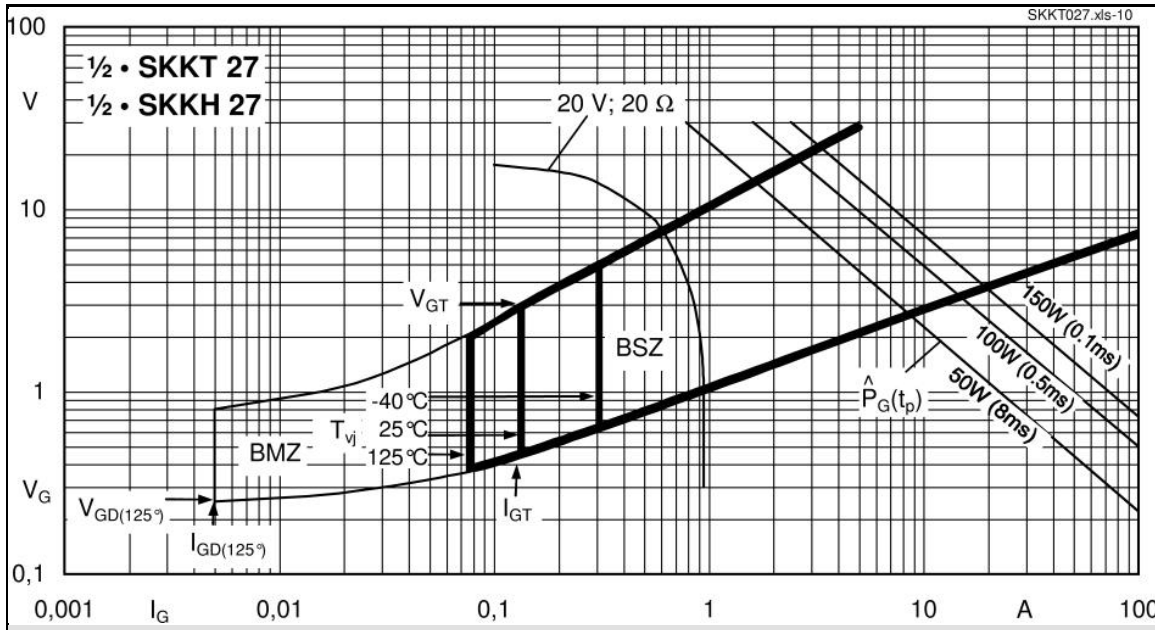
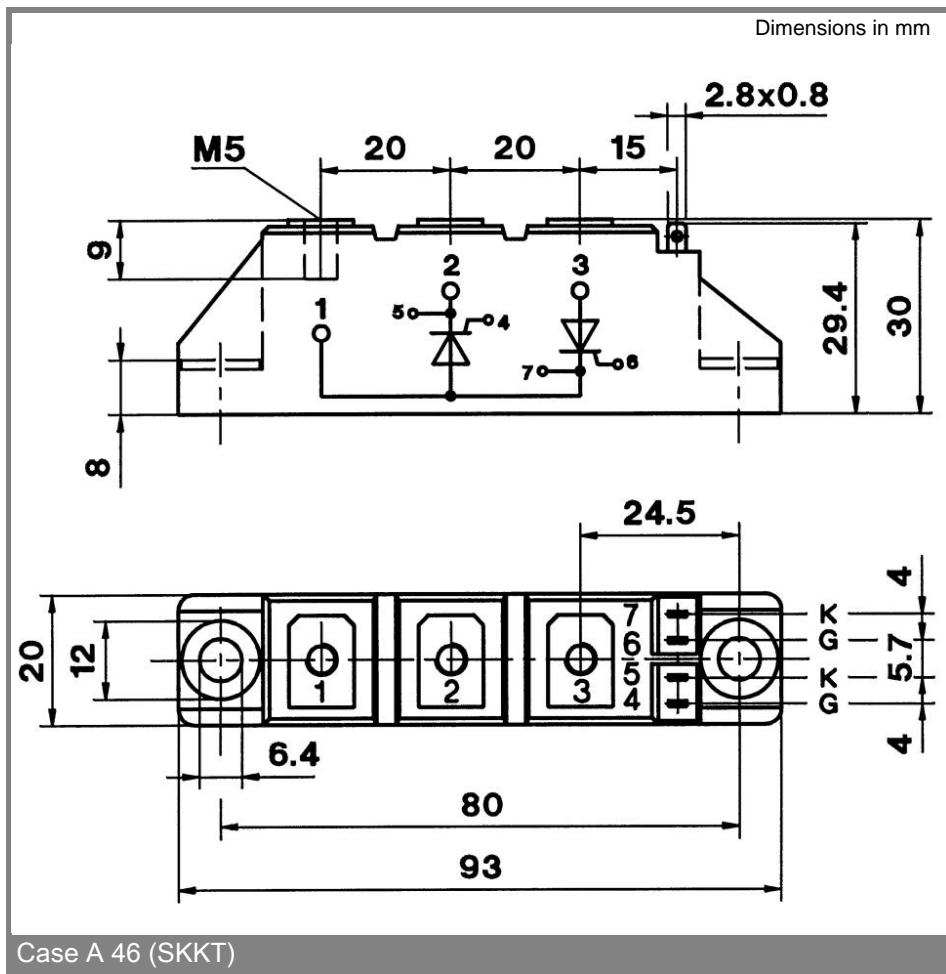
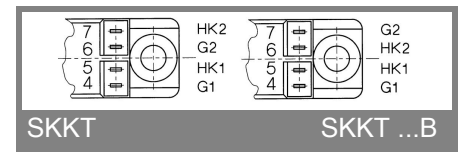
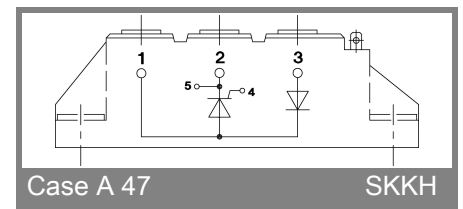
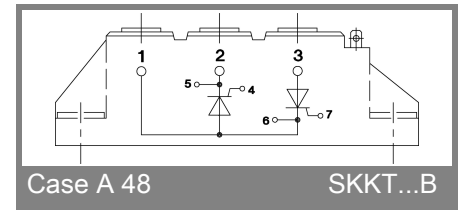

Fig. 9 Gate trigger characteristics



Case A 46 (SKKT)



\* The specifications of our components may not be considered as an assurance of component characteristics. Components have to be tested for the respective application. Adjustments may be necessary. The use of SEMIKRON products in life support appliances and systems is subject to prior specification and written approval by SEMIKRON. We therefore strongly recommend prior consultation of our personal.