



Inductors for Decoupling Circuits

Multilayer Ferrite

MLZ Series

MLZ2012 Type

MLZ2012

2012 [0805 inch]*

* Dimensions Code JIS[EIA]

REMINDERS FOR USING THESE PRODUCTS

Before using these products, be sure to request the delivery specifications.

SAFETY REMINDERS

Please pay sufficient attention to the warnings for safe designing when using these products.

REMINDERS

- The storage period is less than 12 months. Be sure to follow the storage conditions (Temperature: 5 to 40°C, Humidity: 10 to 75% RH or less).
If the storage period elapses, the soldering of the terminal electrodes may deteriorate.
- Do not use or store in locations where there are conditions such as gas corrosion (salt, acid, alkali, etc.).
- Before soldering, be sure to preheat components.
The preheating temperature should be set so that the temperature difference between the solder temperature and chip temperature does not exceed 150°C.
- Soldering corrections after mounting should be within the range of the conditions determined in the specifications.
If overheated, a short circuit, performance deterioration, or lifespan shortening may occur.
- When embedding a printed circuit board where a chip is mounted to a set, be sure that residual stress is not given to the chip due to the overall distortion of the printed circuit board and partial distortion such as at screw tightening portions.
- Self heating (temperature increase) occurs when the power is turned ON, so the tolerance should be sufficient for the set thermal design.
- Carefully lay out the coil for the circuit board design of the non-magnetic shield type.
A malfunction may occur due to magnetic interference.
- Use a wrist band to discharge static electricity in your body through the grounding wire.
- Do not expose the products to magnets or magnetic fields.
- Do not use for a purpose outside of the contents regulated in the delivery specifications.
- The products listed on this catalog are intended for use in general electronic equipment (AV equipment, telecommunications equipment, home appliances, amusement equipment, computer equipment, personal equipment, office equipment, measurement equipment, industrial robots) under a normal operation and use condition.
The products are not designed or warranted to meet the requirements of the applications listed below, whose performance and/or quality require a more stringent level of safety or reliability, or whose failure, malfunction or trouble could cause serious damage to society, person or property.
If you intend to use the products in the applications listed below or if you have special requirements exceeding the range or conditions set forth in the each catalog, please contact us.

- (1) Aerospace/Aviation equipment
- (2) Transportation equipment (cars, electric trains, ships, etc.)
- (3) Medical equipment
- (4) Power-generation control equipment
- (5) Atomic energy-related equipment
- (6) Seabed equipment
- (7) Transportation control equipment

- (8) Public information-processing equipment
- (9) Military equipment
- (10) Electric heating apparatus, burning equipment
- (11) Disaster prevention/crime prevention equipment
- (12) Safety equipment
- (13) Other applications that are not considered general-purpose applications

When designing your equipment even for general-purpose applications, you are kindly requested to take into consideration securing protection circuit/device or providing backup circuits in your equipment.

Inductors for Decoupling Circuits

Multilayer Ferrite

Product compatible with RoHS directive
Halogen-free
Compatible with lead-free solders

Overview of MLZ2012 Type

FEATURES

- The MLZ Series include inductors for decoupling circuits that have top-class DC superimposition characteristics and low DC resistance.
- They are compatible with wide frequency band noise, from low to high frequency.
- H type products have a rated current that is equivalent to that of wound coils.
- W type products are the new standard type products that have both large current and low resistance.
- L type products have a resistance up to 60% lower than W type products.

APPLICATION

Smart phones, tablet terminals, laptop computers, various modules such as camera modules, DSCs, video games, portable memory audio devices, navigation systems, PNDs, WLANs, SSDs

PART NUMBER CONSTRUCTION

MLZ	2012	M	1R0	H	T	000			
Series name	LxWxH Dimensions (mm)	Product internal code	Inductance (μH)		Characteristic type		Packaging style		Internal code
2012	2.0×1.25×0.85	A	1R0	1	H	Ultra-large current type		T	000
	2.0×1.25×1.25	D	100	10	D	High frequency type		Taping	
		M	101	100	W	Large current type			
		N			L	Low resistance type			

OPERATING TEMPERATURE RANGE, PACKAGE QUANTITY, PRODUCT WEIGHT

Type	Temperature range		Package quantity (pieces/reel)	Individual weight (mg)
	Operating temperature* (°C)	Storage temperature** (°C)		
MLZ2012	t=0.85	-55 to +125	4000	10
	t=1.25		2000	14

* Operating temperature range includes self-temperature rise.

** The Storage temperature range is for after the circuit board is mounted.

- RoHS Directive Compliant Product: See the following for more details related to RoHS Directive compliant products. <http://product.tdk.com/en/environment/rohs/>
- Halogen-free: Indicates that Cl content is less than 900ppm, Br content is less than 900ppm, and that the total Cl and Br content is less than 1500ppm.

 Please be sure to request delivery specifications that provide further details on the features and specifications of the products for proper and safe use. Please note that the contents may change without any prior notice due to reasons such as upgrading.

MLZ2012 Type

RECOMMENDED REFLOW PROFILE



Preheating			Soldering		Peak	
Temp.	Temp.	Time	Temp.	Time	Temp.	Time
T1	T2	t1	T3	t2	T4	t3
150°C	180°C	60 to 120s	230°C	30 to 60s	250 to 260°C	10s max.

MLZ2012 Type

SHAPE & DIMENSIONS

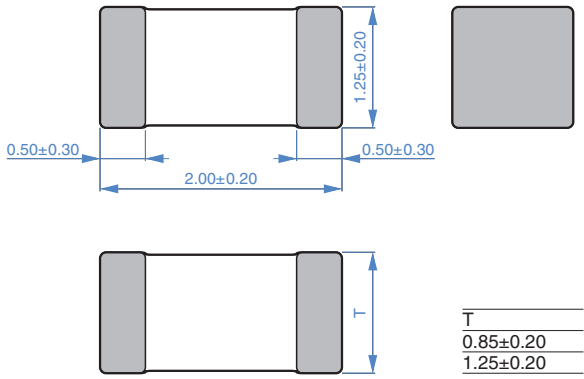

Dimensions in mm



RECOMMENDED LAND PATTERN

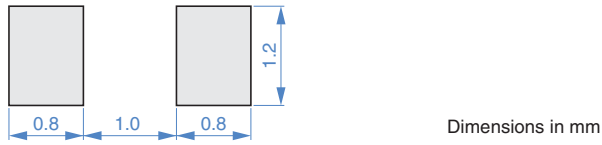

Dimensions in mm

 Please be sure to request delivery specifications that provide further details on the features and specifications of the products for proper and safe use. Please note that the contents may change without any prior notice due to reasons such as upgrading.

MLZ2012 Type

ELECTRICAL CHARACTERISTICS

CHARACTERISTICS SPECIFICATION TABLE

Type	L		Thickness		L measuring conditions		DC resistance	Rated current*1	Rated current*2	Part No.
	(μ H)	Tolerance	T (mm)	Frequency (MHz)	Current (mA)	(Ω) \pm 30%				
Ultra-large current	1.0	\pm 20%	1.25	2	0.1	0.10	700	800	MLZ2012M1R0HT000	
	1.5	\pm 20%	1.25	2	0.1	0.14	550	700	MLZ2012M1R5HT000	
	2.2	\pm 20%	1.25	2	0.1	0.16	400	600	MLZ2012M2R2HT000	
	3.3	\pm 20%	1.25	2	0.1	0.20	350	500	MLZ2012M3R3HT000	
	4.7	\pm 20%	1.25	2	0.1	0.34	300	400	MLZ2012M4R7HT000	
	6.8	\pm 20%	1.25	2	0.1	0.40	220	350	MLZ2012M6R8HT000	
High frequency	10	\pm 20%	1.25	2	0.1	0.68	200	300	MLZ2012M100HT000	
	0.10	\pm 20%	0.85	25	1.0	0.07	1000	1150	MLZ2012DR10DT000	
	0.22	\pm 20%	0.85	25	1.0	0.13	800	900	MLZ2012DR22DT000	
Large current	0.47	\pm 20%	1.25	25	1.0	0.18	550	700	MLZ2012DR47DT000	
	1.00	\pm 20%	0.85	10	1.0	0.10	280	900	MLZ2012A1R0WT000	
	1.50	\pm 20%	0.85	10	1.0	0.13	250	750	MLZ2012A1R5WT000	
	2.20	\pm 20%	0.85	10	1.0	0.15	210	650	MLZ2012A2R2WT000	
	3.30	\pm 20%	0.85	10	1.0	0.34	200	450	MLZ2012A3R3WT000	
	4.70	\pm 20%	0.85	2	0.1	0.30	180	500	MLZ2012M4R7WT000	
	6.80	\pm 20%	1.25	2	0.1	0.40	160	400	MLZ2012M6R8WT000	
	10.0	\pm 20%	1.25	2	0.1	0.47	150	350	MLZ2012M100WT000	
	15.0	\pm 20%	1.25	2	0.1	0.95	120	250	MLZ2012M150WT000	
	22.0	\pm 20%	1.25	2	0.1	1.25	100	220	MLZ2012P220WT000	
Low resistance	22.0	\pm 20%	1.25	2	0.1	2.0	60	220	MLZ2012M220WT000	
	33.0	\pm 20%	1.25	2	0.1	2.60	55	190	MLZ2012M330WT000	
	47.0	\pm 20%	1.25	2	0.1	3.70	50	170	MLZ2012M470WT000	
	1.00	\pm 20%	0.85	2	0.1	0.06	220	1150	MLZ2012N1R0LT000	
	1.50	\pm 20%	0.85	2	0.1	0.10	190	900	MLZ2012N1R5LT000	
	2.20	\pm 20%	0.85	2	0.1	0.12	170	800	MLZ2012N2R2LT000	
	3.30	\pm 20%	0.85	2	0.1	0.15	130	750	MLZ2012N3R3LT000	
	4.70	\pm 20%	0.85	2	0.1	0.18	130	600	MLZ2012N4R7LT000	
	6.80	\pm 20%	0.85	2	0.1	0.25	110	550	MLZ2012N6R8LT000	
	10.0	\pm 20%	1.25	2	0.1	0.30	110	500	MLZ2012N100LT000	
	15.0	\pm 20%	1.25	2	0.1	0.47	90	350	MLZ2012N150LT000	
	22.0	\pm 20%	1.25	2	0.1	0.67	70	300	MLZ2012N220LT000	
	100.0	\pm 20%	1.25	2	0.1	3.50	30	140	MLZ2012N101LT000	

*1 Current assumed when inductance ratio has decreased by 50% max..

*2 Current assumed when temperature has risen to 20°C max. (reference value).
Operating temperature environment at this time: 105°C max.

Measurement equipment

Measurement item	Product No.	Manufacturer
L	4294A+16034G	Agilent Technologies
DC resistance	Type-7561	Yokogawa

* Equivalent measurement equipment may be used.

MLZ2012 Type

ELECTRICAL CHARACTERISTICS

L FREQUENCY CHARACTERISTICS GRAPH H CHARACTERISTIC PRODUCT

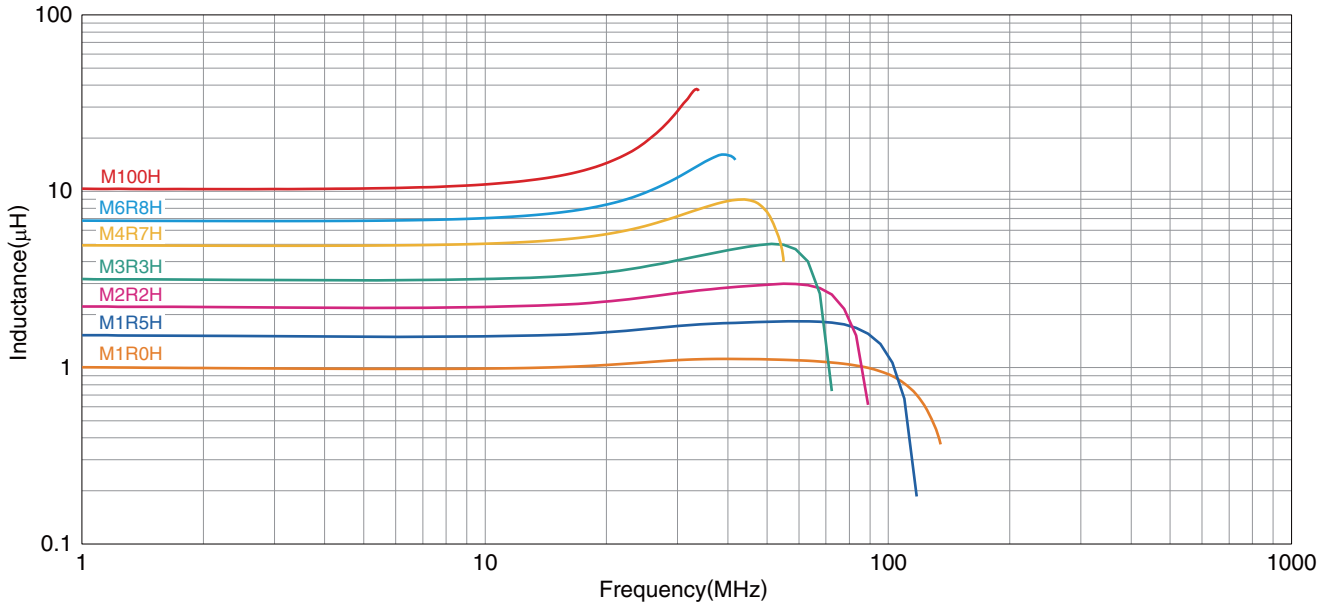

○ Measurement equipment

Product No.	Manufacturer
E4991A+16192A	Agilent Technologies

* Equivalent measurement equipment may be used.

L FREQUENCY CHARACTERISTICS GRAPH D CHARACTERISTIC PRODUCT

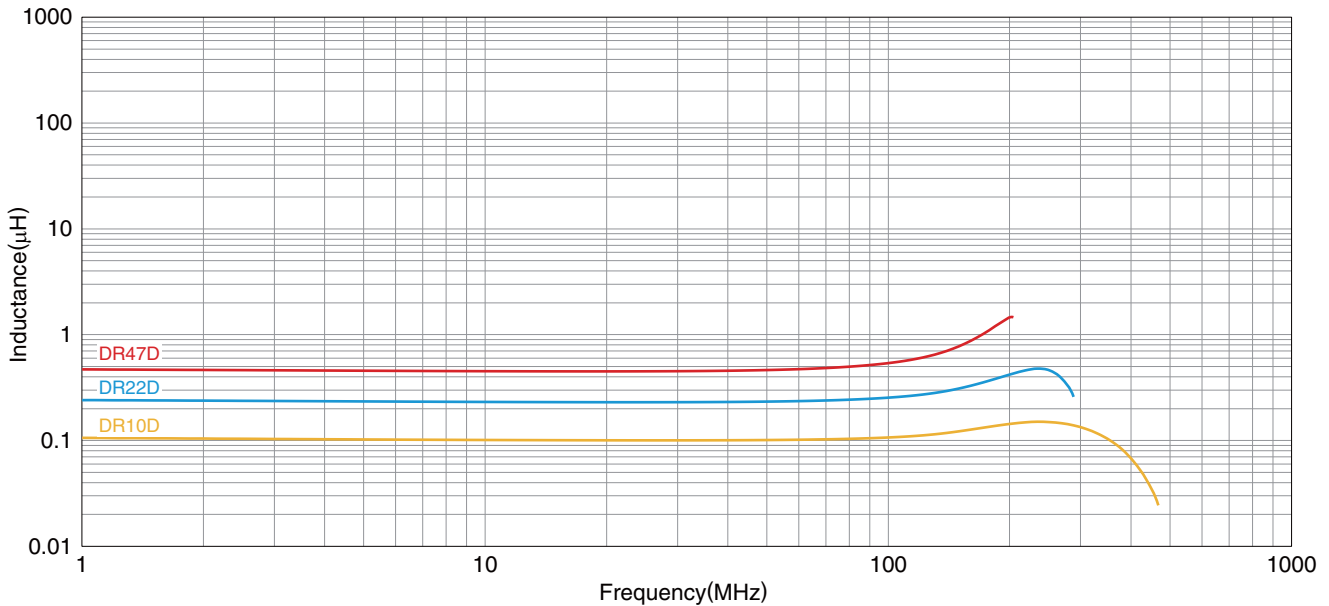

○ Measurement equipment

Product No.	Manufacturer
E4991A+16192A	Agilent Technologies

* Equivalent measurement equipment may be used.

 Please be sure to request delivery specifications that provide further details on the features and specifications of the products for proper and safe use. Please note that the contents may change without any prior notice due to reasons such as upgrading.

MLZ2012 Type

ELECTRICAL CHARACTERISTICS

L FREQUENCY CHARACTERISTICS GRAPH W CHARACTERISTIC PRODUCT

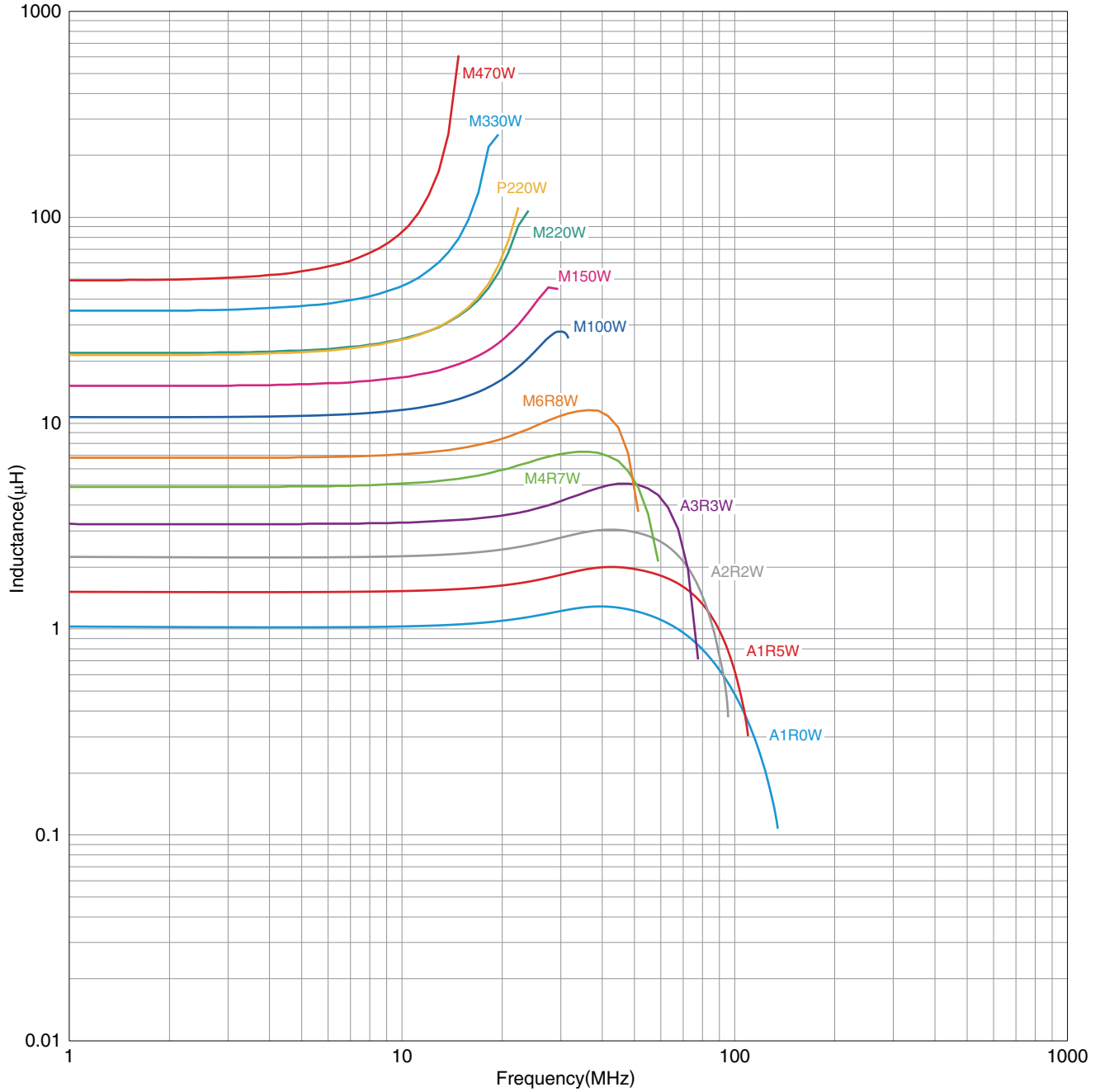

○ Measurement equipment

Product No.	Manufacturer
E4991A+16192A	Agilent Technologies

* Equivalent measurement equipment may be used.

 Please be sure to request delivery specifications that provide further details on the features and specifications of the products for proper and safe use. Please note that the contents may change without any prior notice due to reasons such as upgrading.

MLZ2012 Type

ELECTRICAL CHARACTERISTICS

L FREQUENCY CHARACTERISTICS GRAPH L CHARACTERISTIC PRODUCT

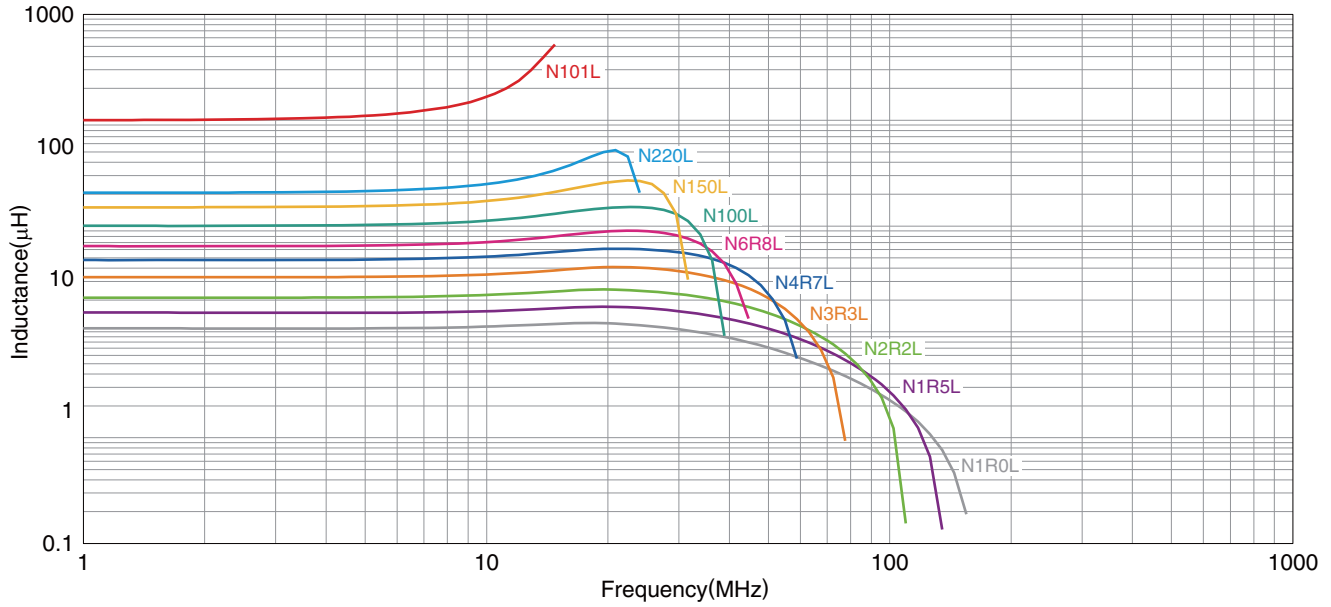

○ Measurement equipment

Product No.	Manufacturer
E4991A+16192A	Agilent Technologies

* Equivalent measurement equipment may be used.

MLZ2012 Type

ELECTRICAL CHARACTERISTICS

INDUCTANCE VS. DC BIAS CHARACTERISTICS GRAPH H CHARACTERISTIC PRODUCT

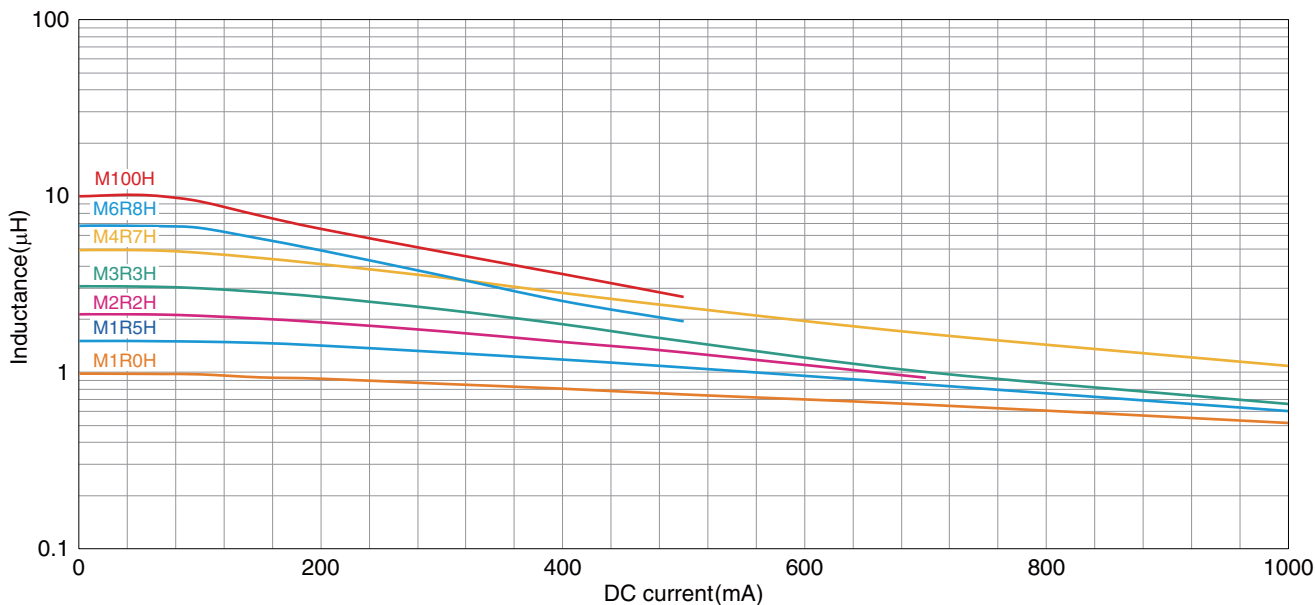

○ Measurement equipment

Product No.	Manufacturer
4291B+16200A+16192A	Agilent Technologies

* Equivalent measurement equipment may be used.

INDUCTANCE VS. DC BIAS CHARACTERISTICS GRAPH D CHARACTERISTIC PRODUCT

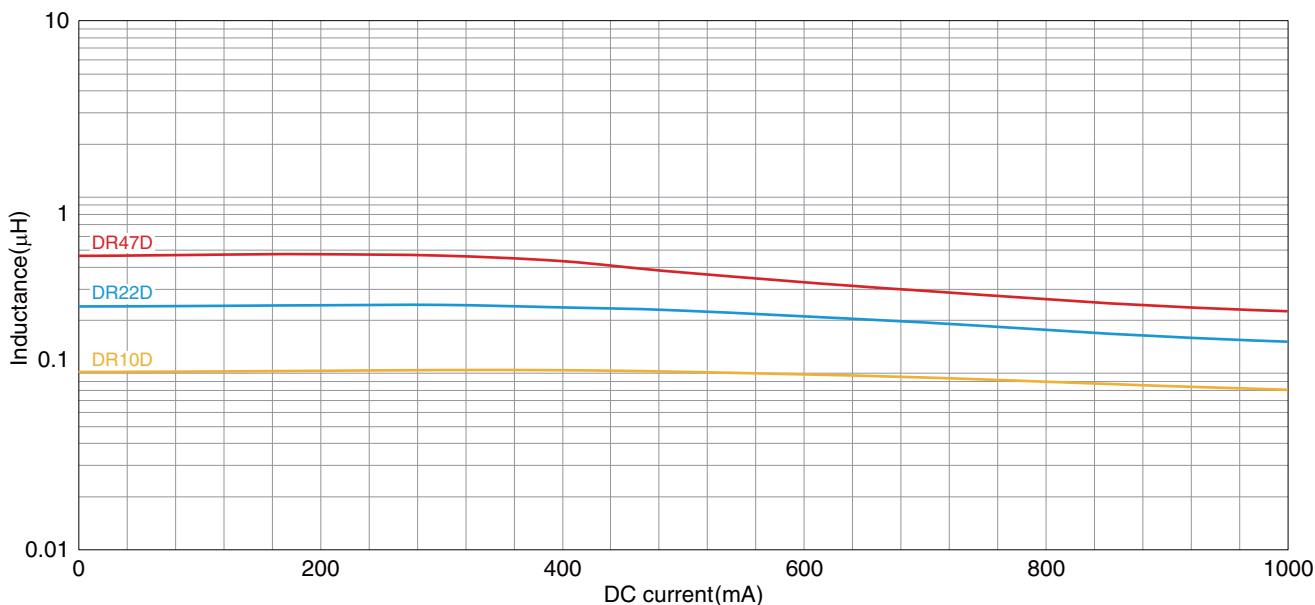

○ Measurement equipment

Product No.	Manufacturer
4291B+16200A+16192A	Agilent Technologies

* Equivalent measurement equipment may be used.

 Please be sure to request delivery specifications that provide further details on the features and specifications of the products for proper and safe use. Please note that the contents may change without any prior notice due to reasons such as upgrading.

MLZ2012 Type

ELECTRICAL CHARACTERISTICS

INDUCTANCE VS. DC BIAS CHARACTERISTICS GRAPH (EXAMPLE) W CHARACTERISTIC PRODUCT

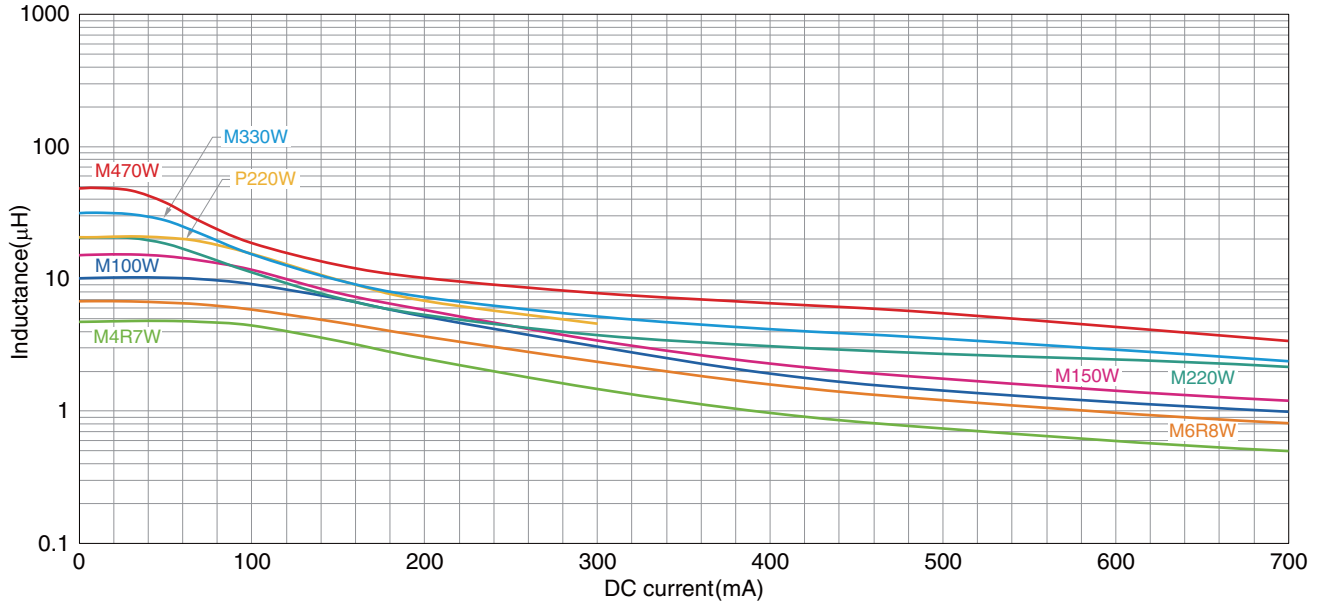

○ Measurement equipment

Product No.	Manufacturer
4291B+16200A+16192A	Agilent Technologies

* Equivalent measurement equipment may be used.

INDUCTANCE VS. DC BIAS CHARACTERISTICS GRAPH L CHARACTERISTIC PRODUCT

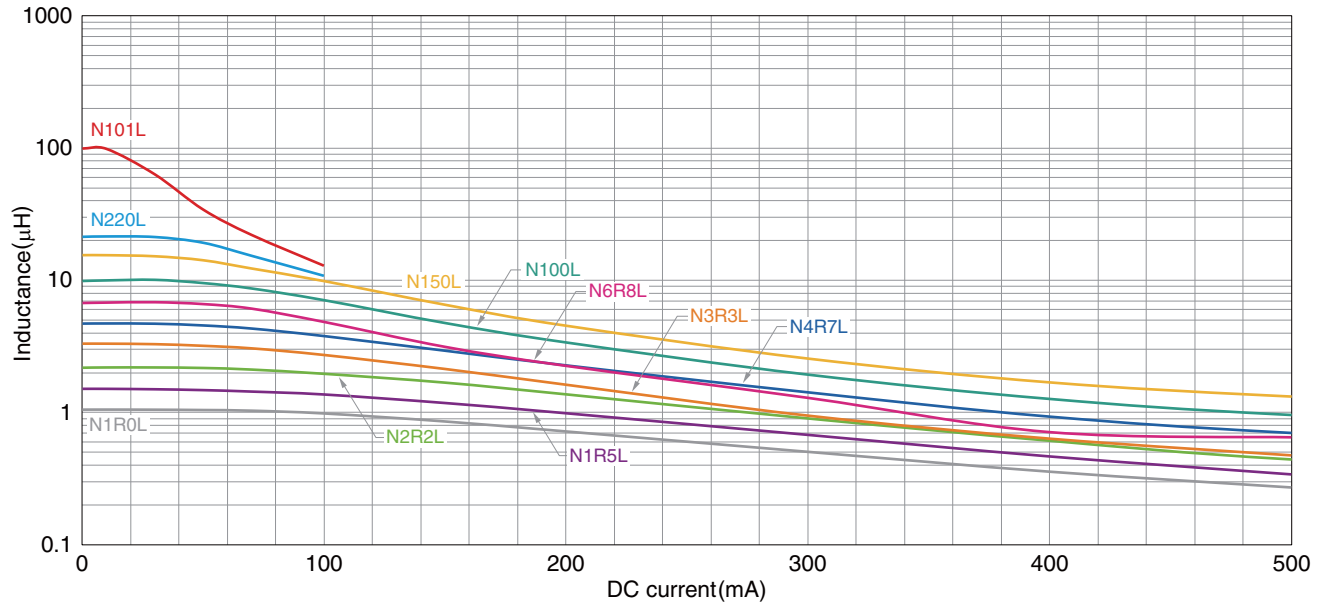

○ Measurement equipment

Product No.	Manufacturer
4291B+16200A+16192A	Agilent Technologies

* Equivalent measurement equipment may be used.

 Please be sure to request delivery specifications that provide further details on the features and specifications of the products for proper and safe use. Please note that the contents may change without any prior notice due to reasons such as upgrading.

MLZ2012 Type

ELECTRICAL CHARACTERISTICS

IMPEDANCE FREQUENCY CHARACTERISTICS GRAPH H CHARACTERISTIC PRODUCT

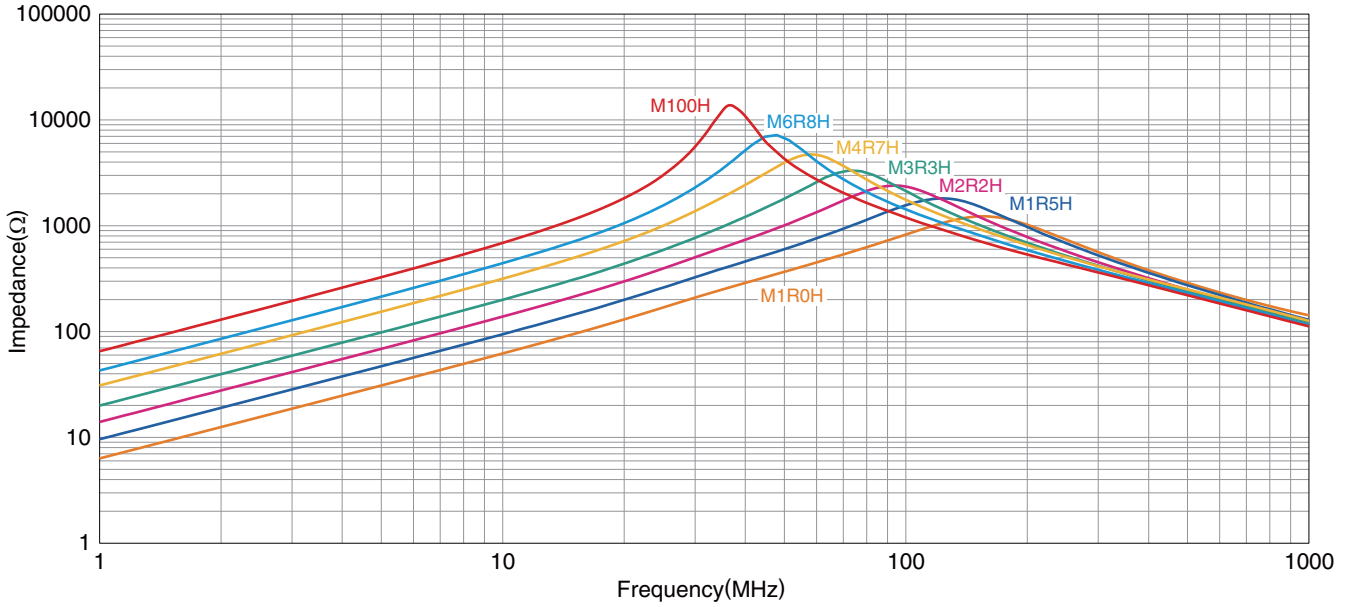

○ Measurement equipment

Product No.	Manufacturer
E4991A+16192A	Agilent Technologies

* Equivalent measurement equipment may be used.

IMPEDANCE FREQUENCY CHARACTERISTICS GRAPH D CHARACTERISTIC PRODUCT

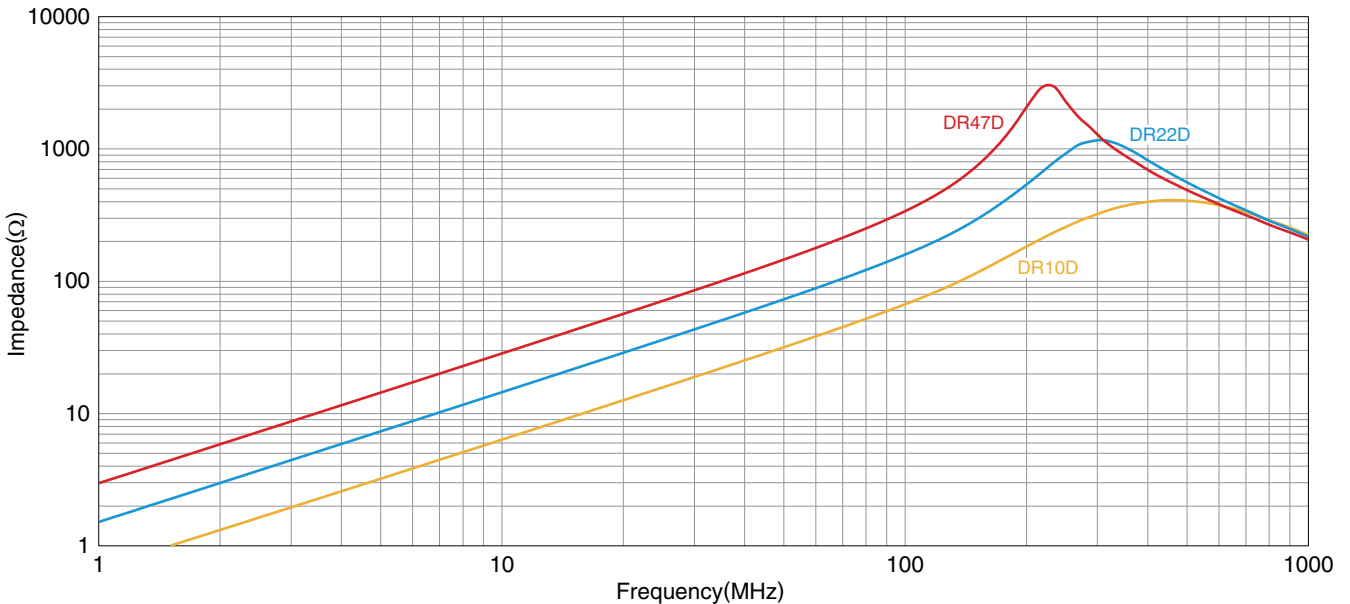

○ Measurement equipment

Product No.	Manufacturer
E4991A+16192A	Agilent Technologies

* Equivalent measurement equipment may be used.

 Please be sure to request delivery specifications that provide further details on the features and specifications of the products for proper and safe use. Please note that the contents may change without any prior notice due to reasons such as upgrading.

MLZ2012 Type

ELECTRICAL CHARACTERISTICS

IMPEDANCE FREQUENCY CHARACTERISTICS GRAPH W CHARACTERISTIC PRODUCT

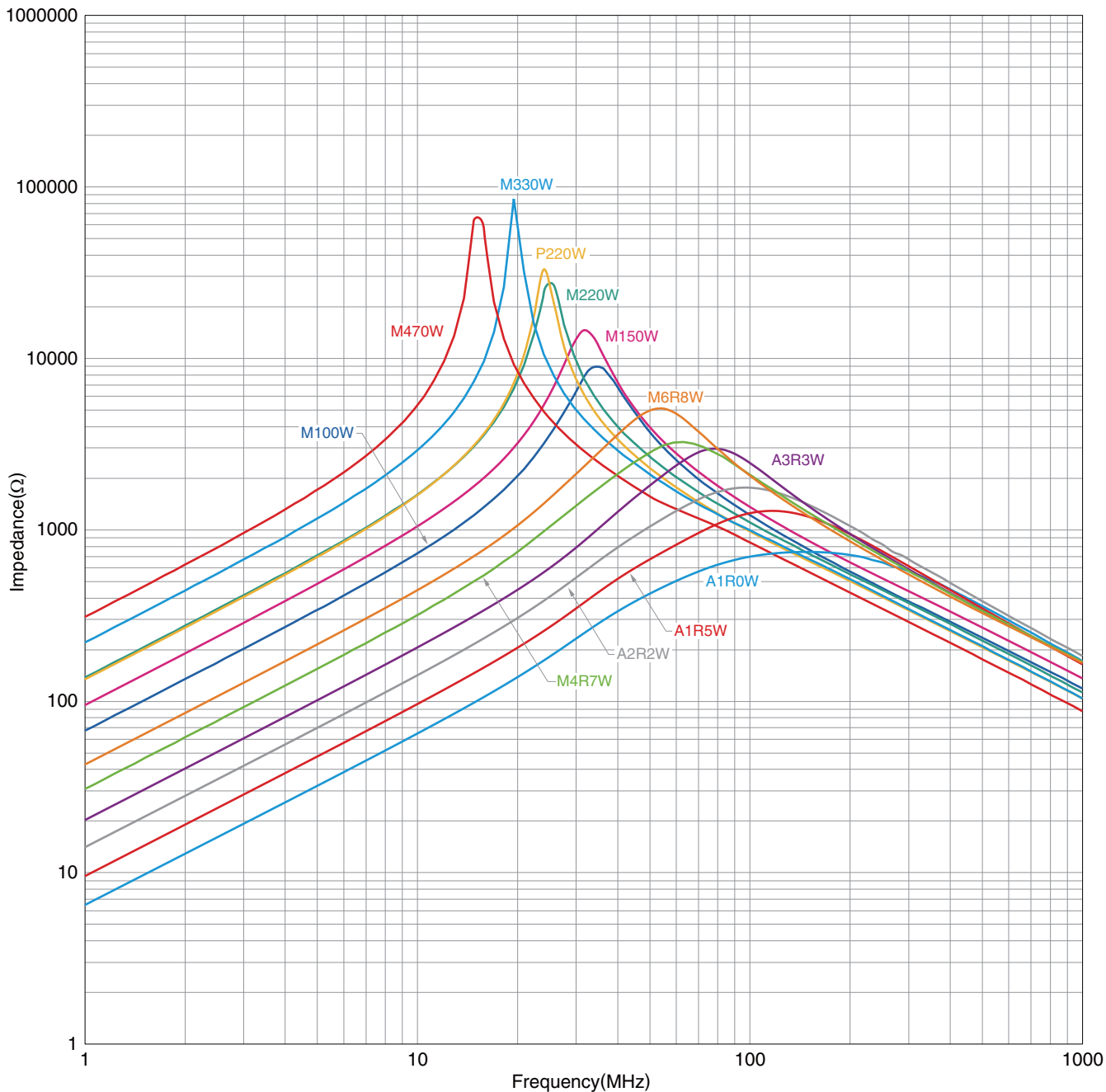

○ Measurement equipment

Product No.	Manufacturer
E4991A+16192A	Agilent Technologies

* Equivalent measurement equipment may be used.

Please be sure to request delivery specifications that provide further details on the features and specifications of the products for proper and safe use. Please note that the contents may change without any prior notice due to reasons such as upgrading.

MLZ2012 Type

ELECTRICAL CHARACTERISTICS

IMPEDANCE FREQUENCY CHARACTERISTICS GRAPH L CHARACTERISTIC PRODUCT

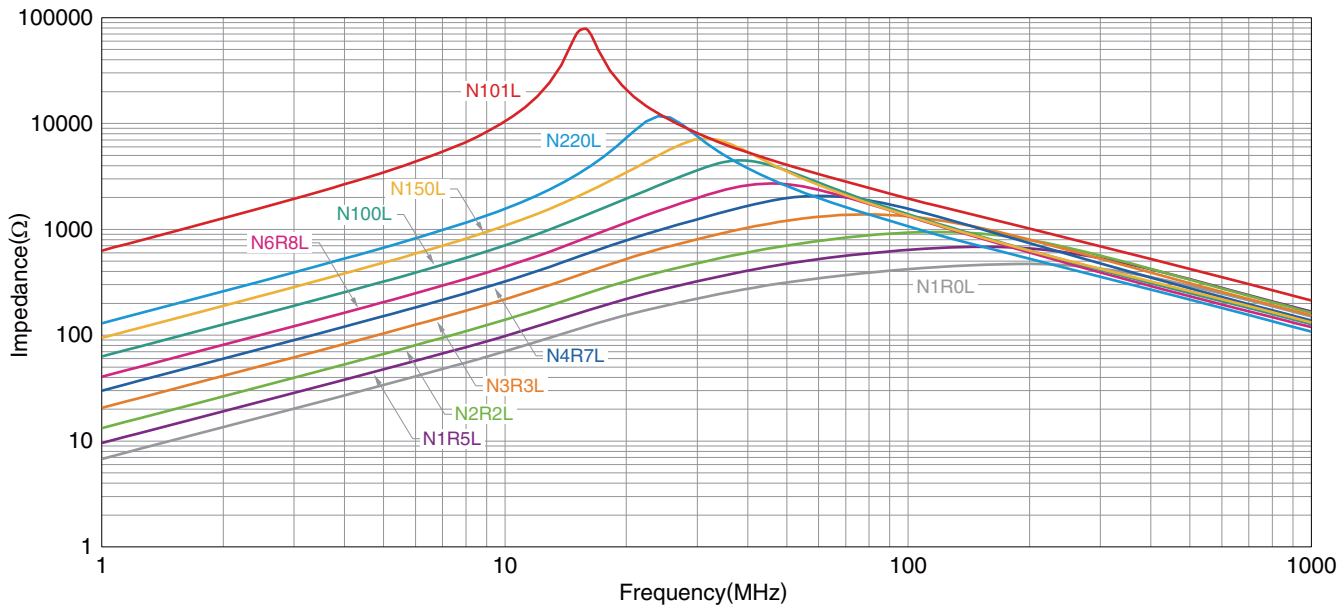

○ Measurement equipment

Product No.	Manufacturer
E4991A+16192A	Agilent Technologies

* Equivalent measurement equipment may be used.

 Please be sure to request delivery specifications that provide further details on the features and specifications of the products for proper and safe use. Please note that the contents may change without any prior notice due to reasons such as upgrading.

MLZ2012 Type

PACKAGING STYLE

REEL DIMENSIONS

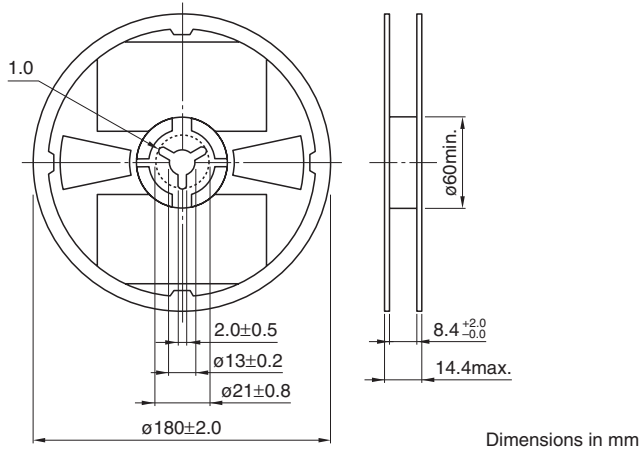

TAPE DIMENSIONS

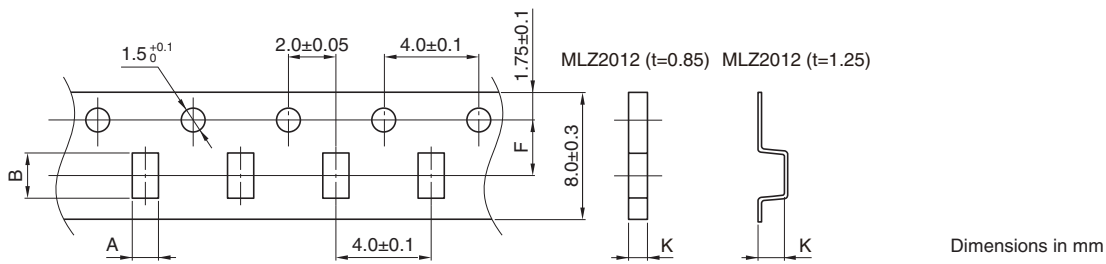

Type		A	B	K
MLZ2012	t=0.85	2.3±0.2	1.5±0.2	1.1 max.
	t=1.25	2.3±0.2	1.5±0.2	1.5 max.

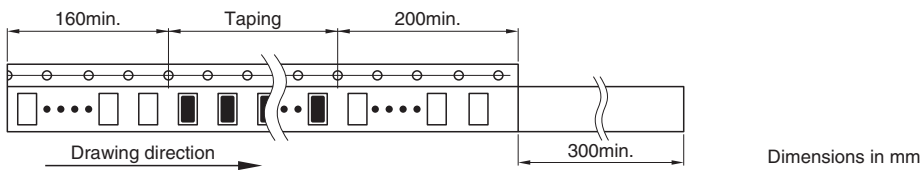

 Please be sure to request delivery specifications that provide further details on the features and specifications of the products for proper and safe use. Please note that the contents may change without any prior notice due to reasons such as upgrading.