

Q4X Stainless Steel Laser Sensor

Instruction Manual

Original Instructions
181483 Rev. D
6 January 2015



181483

Contents

1	Product Description	3
1.1	Models	3
1.2	Overview	3
1.3	Features	4
1.3.1	Display and Indicators	4
1.3.2	Buttons	4
1.4	Laser Description and Safety Information	5
2	Installation	6
2.1	Install the Safety Label	6
2.2	Sensor Orientation	6
2.3	Sensor Mounting	7
2.4	Wiring Diagram	7
2.5	Cleaning and Maintenance	7
3	Sensor Programming	8
3.1	Light Operate/Dark Operate	8
3.2	Setup Mode	8
3.2.1	TEACH Menu	10
3.2.2	Response Speed	10
3.2.3	Output Timing Delays	10
3.2.4	Zero Reference Location	11
3.2.5	Shift the Zero Reference Location after a TEACH	12
3.2.6	Input Wire Function	12
3.2.7	Display View	12
3.2.8	Exit Setup Mode	12
3.2.9	Reset to Factory Defaults	12
3.3	Manual Adjustments	13
3.4	Remote Input	13
3.4.1	Select the TEACH Mode Using the Remote Input	14
3.4.2	Reset to Factory Defaults Using the Remote Input	15
3.5	Locking and Unlocking the Sensor Buttons	15
3.6	TEACH Procedures	15
3.6.1	Two-Point Static Background Suppression TEACH	15
3.6.2	Dynamic Background Suppression TEACH	17
3.6.3	One-Point Window (Foreground Suppression)	18
3.6.4	One-Point Background Suppression	20
3.7	Sync Master/Slave	21
4	Specifications	22
4.1	Dimensions	23
4.2	Performance Curves	23
5	Abbreviations	24
6	Troubleshooting	26
7	Accessories	27
7.1	Cordsets	27
7.2	Brackets	28
7.3	Aperture Kits	28
8	Contact Us	29
9	Banner Engineering Corp Limited Warranty	30

1 Product Description

Class 1 laser CMOS sensor with a bipolar (1 PNP & 1 NPN) output. Patent pending.

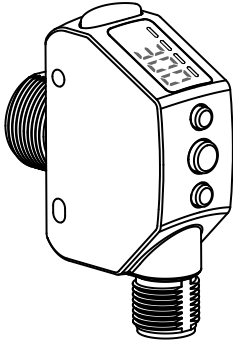

- The ultimate problem solver: reduce sensor inventory with a reliable, durable sensor that solves the most challenging applications
- Solves difficult distance-based applications regardless of target surface reflectivity, including black foam on black plastic, black rubber in front of metal, multicolor packaging and targets of all colors
- Reliable sensing range of 25 mm (0.98 in) to 300 mm (11.81 in) with best in class excess gain
- Angled four-digit display with submillimeter resolution is easily viewed from multiple vantage points
- Display provides clear user feedback for easy setup, and bright output indicator provides high visibility of sensor operation
- Intuitive setup utilizing three tactile buttons conveniently located below the display
- Durable and robust construction resists mechanical impact, over tightening and extreme vibration
- FDA grade stainless steel, chemically-resistant material and laser marked sensor information withstands aggressive cleaning procedures
- Superior resistance to ambient light interference prevents nuisance output trips under changing lighting conditions
- Temperature-compensated design ensures reliable detection during changing temperature conditions



WARNING: Not To Be Used for Personnel Protection

Never use this device as a sensing device for personnel protection. Doing so could lead to serious injury or death. This device does not include the self-checking redundant circuitry necessary to allow its use in personnel safety applications. A sensor failure or malfunction can cause either an energized or de-energized sensor output condition.

1.1 Models

Model	Sensing Range	Output	Cable
Q4XTBLAF300-Q8	25 mm (0.98 in) to 300 mm (11.81 in)	Bipolar: 1 NPN; 1 PNP	5-pin Euro M12 Integral Connector

1.2 Overview

The Q4X Sensor is a Class 1 laser CMOS sensor with a bipolar output. The normal sensor state is Run mode. From Run mode, the switch point value and LO/DO selection can be changed and the selected TEACH method can be performed. The secondary sensor state is Setup mode. From Setup mode, the TEACH mode can be selected, all standard operating parameters can be adjusted, and a factory reset can be done.

1.3 Features

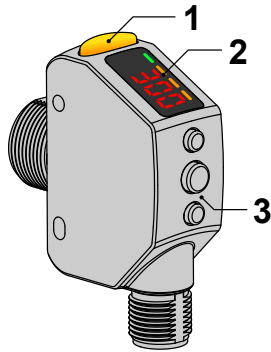

Figure 1. Sensor Features

1. Output Indicator (Amber)
2. Display
3. Buttons

1.3.1 Display and Indicators



Figure 2. Display in Run Mode

The display is a 4-digit, 7-segment LED. The main screen is the Run Mode screen, which shows the current distance to the target in millimeters.

1. Stability Indicator (STB = Green)
2. Active TEACH Indicators
 - DYN = Dynamic (Amber)
 - FGS = Foreground Suppression (Amber)
 - BGS = Background Suppression (Amber)

Output Indicator

- On—Outputs conducting (closed)
- Off—Outputs not conducting (open)

Stability Indicator (STB)

- On—Stable signal within the specified sensing range
- Flashing—Marginal signal, the target is outside the limits of the specified sensing range, or a multiple peak condition exists
- Off—No target detected within the specified sensing range

Active TEACH Indicators (DYN, FGS, and BGS)

- DYN, FGS, and BGS all off = Two-point TEACH mode selected (default)
- DYN on = Dynamic TEACH mode selected
- FGS on = Foreground suppression TEACH mode selected
- BGS on = Background suppression TEACH mode selected

1.3.2 Buttons

Use the sensor buttons (SELECT) (TEACH), (+) (LO/DO), and (-) (MODE) to program the sensor.

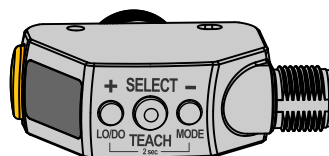

(SELECT) (TEACH)

- Press to select menu items in Setup mode
- Press and hold for longer than 2 seconds to start the currently selected TEACH mode (the default is two-point TEACH)

(+) (LO/DO)

- Press to navigate the sensor menu in Setup mode
- Press to change setting values; press and hold to increase numeric values
- Press and hold for longer than 2 seconds to switch between light operate (LO) and dark operate (DO)

(-) (MODE)

- Press to navigate the sensor menu in Setup mode
- Press to change setting values; press and hold to decrease numeric values
- Press and hold for longer than 2 seconds to enter Setup mode



NOTE: When navigating the menu, the menu items loop.

1.4 Laser Description and Safety Information



CAUTION: Use of controls or adjustments or performance of procedures other than those specified herein may result in hazardous radiation exposure. Do not attempt to disassemble this sensor for repair. A defective unit must be returned to the manufacturer.

Class 1 Lasers

Class 1 lasers are lasers that are safe under reasonably foreseeable conditions of operation, including the use of optical instruments for intrabeam viewing.



Laser wavelength: 655 nm

Output: < 0.20 mW

Pulse Duration: 7 μ s to 2 ms

2 Installation

2.1 Install the Safety Label

The safety label must be installed on Q4X sensors that are used in the United States.



NOTE: Position the label on the cable in a location that has minimal chemical exposure.

1. Remove the protective cover from the adhesive on the label.
2. Wrap the label around the Q4X cable, as shown.
3. Press the two halves of the label together.

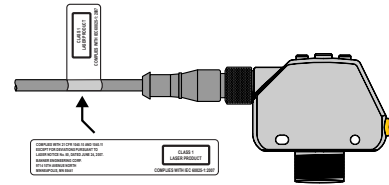

Figure 3. Safety Label Installation

2.2 Sensor Orientation

Optimize detection reliability and minimum object separation performance with correct sensor-to-target orientation. To ensure reliable detection, orient the sensor as shown in relation to the target to be detected.

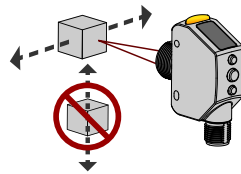

Figure 4. Optimal Orientation of Target to Sensor

See the following figures for examples of correct and incorrect sensor-to-target orientation as certain placements may pose problems for sensing some targets. The Q4X can be used in the less preferred orientation and provide reliable detection performance; see [Figure 16](#) on page 23 for the minimum object separation distance required for each case.

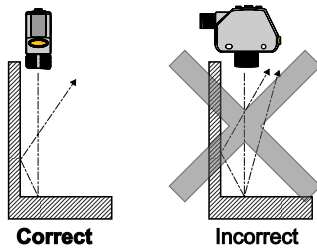

Figure 5. Orientation by a wall

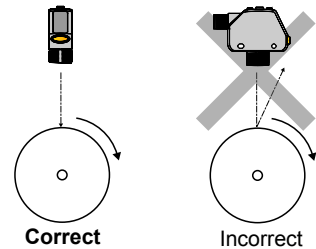

Figure 6. Orientation for a turning object

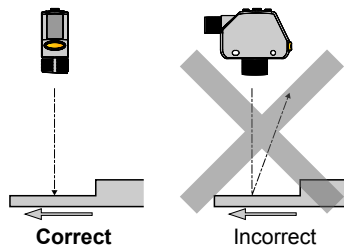

Figure 7. Orientation for a height difference

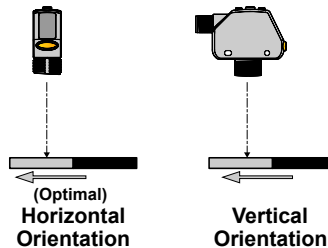
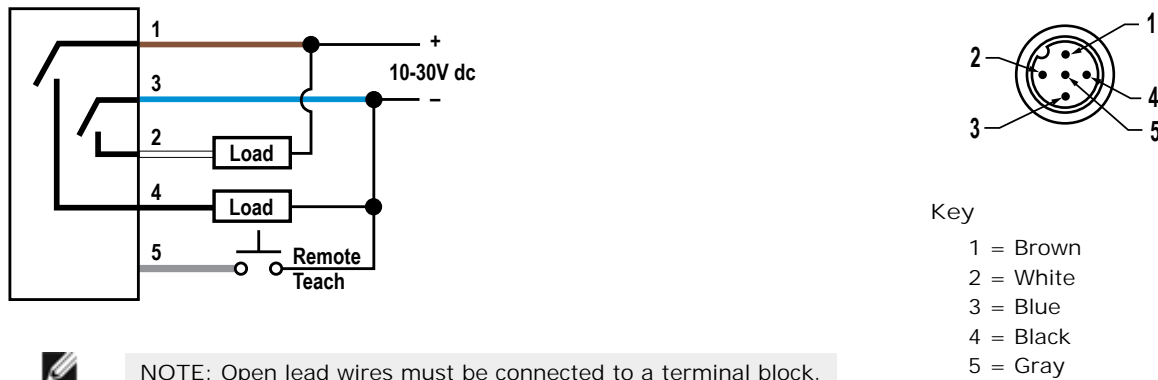

Figure 8. Orientation for a color or luster difference

2.3 Sensor Mounting

1. If a bracket is needed, mount the sensor onto the bracket.
2. Mount the sensor (or the sensor and the bracket) to the machine or equipment at the desired location. Do not tighten at this time.
3. Check the sensor alignment.
4. Tighten the screws to secure the sensor (or the sensor and the bracket) in the aligned position.

2.4 Wiring Diagram



NOTE: Open lead wires must be connected to a terminal block.



NOTE: The input wire function is user-selectable. The default for the input wire function is off (disabled).

2.5 Cleaning and Maintenance

Handle the sensor with care during installation and operation. Sensor windows soiled by fingerprints, dust, water, oil, etc. may create stray light that may degrade the peak performance of the sensor. Blow the window clear using filtered, compressed air, then clean as necessary using water and a lint-free cloth.

3 Sensor Programming

Program the sensor using the buttons on the sensor or the remote input (limited programming options).

In addition to programming the sensor, use the remote input to disable the buttons for security, preventing unauthorized or accidental programming changes. See [Locking and Unlocking the Sensor Buttons](#) on page 15 for more information.

3.1 Light Operate/Dark Operate

The default output configuration is light operate. To switch between light operate and dark operate, use the following instructions:

1. Press and hold LO/DO for longer than 2 seconds. The current selection displays.
2. Press LO/DO again. The new selection flashes slowly.
3. Press SELECT to change the output configuration and return to Run mode.



NOTE: If neither SELECT nor LO/DO are pressed after step 2, the new selection flashes slowly for a few seconds, then flashes quickly and the sensor automatically changes the output configuration and returns to Run mode.

3.2 Setup Mode

Access Setup mode and the sensor menu from Run mode by pressing and holding MODE for longer than 2 seconds. Use

⊕ and ⊖ to navigate through the menu. Press SELECT to select a menu option and access the submenus. Use ⊕ and ⊖ to navigate through the submenus. Press SELECT to select a submenu option and return to the top menu, or press and hold SELECT for longer than 2 seconds to select a submenu option and return immediately to Run mode.

To exit Setup mode and return to Run mode, navigate to **End** and press SELECT.

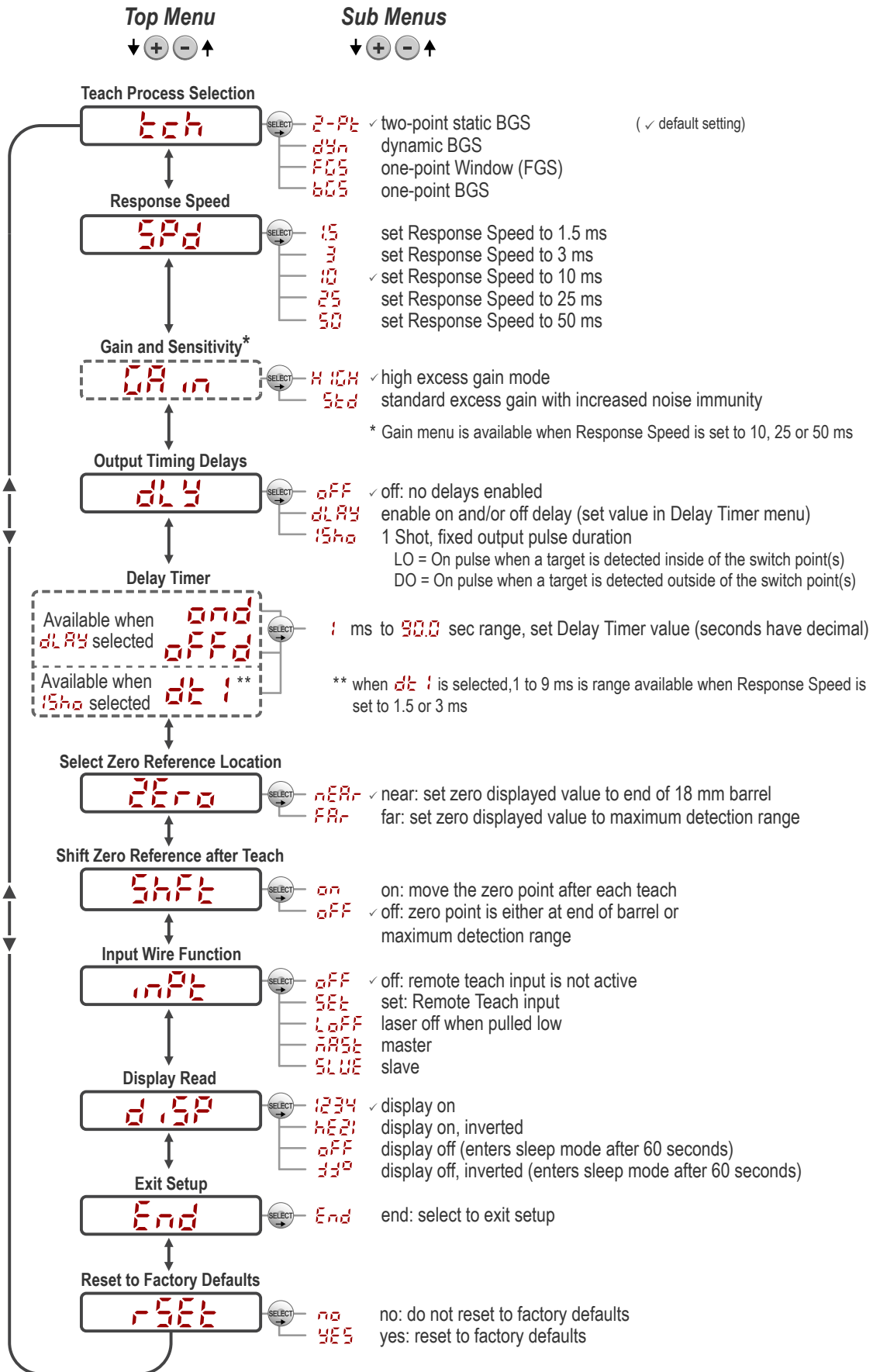

Figure 9. Sensor Menu Map

3.2.1 TEACH Menu **teach**

Use this menu to select the TEACH mode. The default is two-point TEACH.

- **2-pt** —Two-point static background suppression
- **dyn** —Dynamic background suppression
- **FGS** —One-point window (foreground suppression)
- **BGS** —One-point background suppression

After the TEACH mode is selected, from Run mode, press and hold TEACH for longer than 2 seconds to start the TEACH mode and program the sensor. See [TEACH Procedures](#) on page 15 for additional information and remote input TEACH instructions.

3.2.2 Response Speed **SPd**

Use this menu to select the response speed. The default is 10 milliseconds.

- **1.5** —1.5 milliseconds
- **3** —3 milliseconds
- **10** —10 milliseconds
- **25** —25 milliseconds
- **50** —50 milliseconds

Table 1: Tradeoffs

Response Speed	Response Speed in Sync Mode	Repeatability	Ambient Light Rejection	Excess Gain
1.5 ms	3 ms	500 μs	Disabled	See Table 7 on page 22
3 ms	6 ms	500 μs	Enabled	
10 ms	20 ms	2 ms	Enabled	
25 ms	50 ms	5 ms	Enabled	
50 ms	100 ms	10 ms	Enabled	

Gain and Sensitivity **GA n**

Use this menu to set the excess gain mode. This menu is only available when a 10, 25, or 50 millisecond response speed is selected. It is not available for 1.5 or 3 millisecond response speeds.

- **HIGH** —High excess gain mode
- **Std** —Standard excess gain mode with increased noise immunity

3.2.3 Output Timing Delays **dl y**

Use this menu to select the output timing delay to be set. On and off delay timers can be used together. The default is no delay.

- **off** —No delay
- **dlAY** —Delay—enables the selection of on and off delay timers
- **1shot** —One-shot—enables a one-shot, fixed output pulse duration

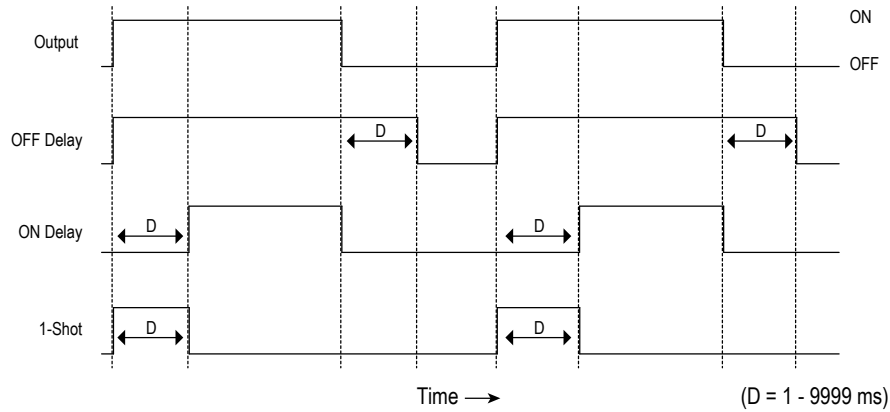

Figure 10. Output Timing Delays

When either `dlAy` or `1Sho` is chosen, the sensor returns to the Setup menu and additional options become available to set the timer(s):

`dlAy`

- `ond` —On delay
- `offd`—Off delay

`1Sho`

- `dt1` —One-shot delay timer



NOTE: For the one-shot delay timer:

- LO = On pulse when a target is detected inside of the switch point(s)
- DO = On pulse when a target is detected outside of the switch point(s)

Delay Timers `ond`, `offd`, `dt1`

Use these menus to set the delay timers. These menus are available only if an output timing delay is selected.

For `ond` and `offd`, the default is 0.

For `dt1`, the default is 10 milliseconds for 10, 25, and 50 millisecond response speeds and 1 millisecond for 1.5 and 3 millisecond response speeds.

Use \oplus and \ominus to scroll through the values. Values greater than 10 increase or decrease by increments of 10. Millisecond values do not include the decimal point; seconds values include the decimal point.

- 1 to 9 ms (when `dt1` is selected, the 1 to 9 ms range is available for 1.5 and 3 ms response times)
- 10 to 90 ms
- 100 to 900 ms
- 1.0 to 90.0 s

3.2.4 Zero Reference Location `Zero`

Use this menu to select the zero reference location. The default is `near`, 0 = the end of the sensor barrel.

- `near` —0 = the end of the sensor barrel; the measurement increases further from the sensor
- `far` —0 = maximum range; the measurement increases closer to the sensor

3.2.5 Shift the Zero Reference Location after a TEACH **SHFT**

Use this menu to select whether the sensor shifts the zero reference location to the last taught distance. The default is **OFF**, 0 = the end of barrel or the maximum range.

- **ON** —Shift the zero reference location to one of the taught positions with each TEACH
- **OFF** —0 = the end of barrel or the maximum range, depending on the **ZERO** setting

3.2.6 Input Wire Function **INPT**

Use this menu to select the input wire function. The default is off, ignore all remote input pulses.

- **OFF** —Ignore all remote input pulses
- **SET** —Remote TEACH input
- **LOFF** —Laser off when pulled low
- **MAST** —Master sync line output for two-sensor cross-talk avoidance
- **SLVE** —Slave sync line input for two-sensor cross-talk avoidance

To configure sensors for master-slave operation, see [Sync Master/Slave](#) on page 21.

3.2.7 Display View **DISP**

Use this menu to select the display view. The default is right-reading.

- **1234** —Right-reading
- **hE21** —Inverted
- **OFF** —Right-reading and the display enters sleep mode after 60 seconds
- **330** —Inverted and the display enters sleep mode after 60 seconds

When the sensor is in sleep mode, the display wakes with the first button press.

3.2.8 Exit Setup Mode **End**

Navigate to **End** and press SELECT to exit Setup mode and return to Run mode.

3.2.9 Reset to Factory Defaults **rSET**

Use this menu to restore the sensor to the factory default settings. See [Factory Default Settings](#) on page 12.



Select **NO** to return to the sensor menu without restoring the defaults. Select **YES** to apply the factory defaults and return to Run mode.





Factory Default Settings

Setting	Factory Default
Display view (DISP)	1234 —Right-reading, no sleep mode
Gain and sensitivity (GAIN)	HIGH —High excess gain mode
Input wire function (INPT)	OFF —Ignore all remote input pulses If the sensor was reset using the remote input, the sensor remains in SET mode to allow use of the remote input.
Output configuration	LO—Light Operate

Setting	Factory Default
Output timing delays (<i>oLd</i>)	<i>oFF</i> —No delay
Response speed (<i>SPd</i>)	10 ms
Shift the Zero Reference Location after a TEACH (<i>SHft</i>)	<i>oFF</i> —0 = the end of barrel
TEACH process selection (<i>tch</i>)	<i>2-pt</i> —Two-point TEACH
Zero reference location (<i>ZErO</i>)	<i>nEAR</i> —Measurement increases further from sensor

3.3 Manual Adjustments

Manually adjust the sensor switch point using the  and  buttons.

1. From Run mode, press either  or  one time. The current switch point value flashes slowly.
2. Press  to move the switch point up or  to move the switch point down. After 1 second of inactivity, the new switch point value flashes rapidly, the new setting is accepted, and the sensor returns to Run mode.



NOTE: When FGS mode is selected (the FGS indicator is on), manual adjustment moves both sides of the symmetrical threshold window simultaneously, expanding and collapsing the window size. Manual adjustment does not move the center point of the window.

3.4 Remote Input

Use the remote input to program the sensor remotely. The remote input provides limited programming options and is Active Low. For Active Low, connect the gray input wire to ground (0 V dc), with a remote switch connected between the wire and ground. Pulse the remote input according to the diagram and the instructions provided in this manual.

The length of the individual programming pulses is equal to the value T: 0.04 seconds \leq T \leq 0.8 seconds.

Exit remote programming modes by setting the remote input low for longer than 2 seconds.

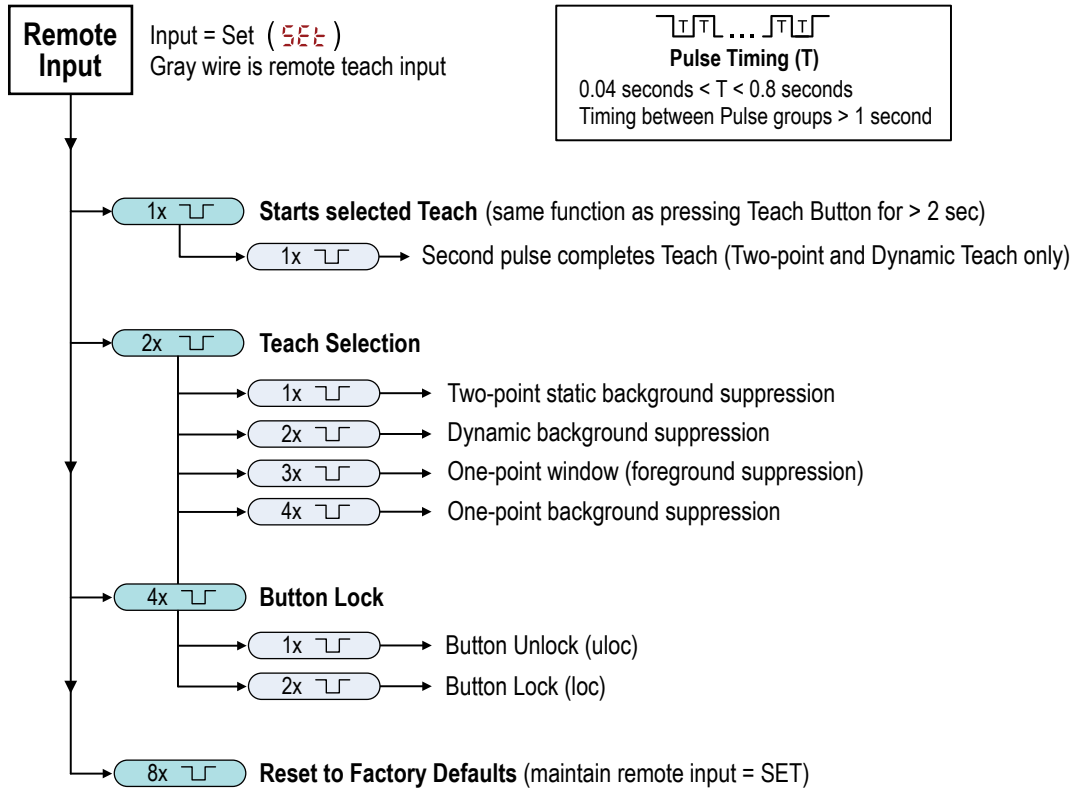

Figure 11. Remote Input Map

3.4.1 Select the TEACH Mode Using the Remote Input

1. Access the TEACH selection.

Action	Result
Double-pulse the remote input.	teach displays.

2. Select the desired TEACH mode.

Action	Result										
<table border="1"> <thead> <tr> <th>Pulses</th> <th>TEACH Mode</th> </tr> </thead> <tbody> <tr> <td>1 </td> <td>Two-point static background suppression</td> </tr> <tr> <td>2 </td> <td>Dynamic background suppression</td> </tr> <tr> <td>3 </td> <td>One-point window (foreground suppression)</td> </tr> <tr> <td>4 </td> <td>One-point background suppression</td> </tr> </tbody> </table>	Pulses	TEACH Mode	1	Two-point static background suppression	2	Dynamic background suppression	3	One-point window (foreground suppression)	4	One-point background suppression	The selected TEACH method displays for a few seconds and the sensor returns to Run mode.
Pulses	TEACH Mode										
1	Two-point static background suppression										
2	Dynamic background suppression										
3	One-point window (foreground suppression)										
4	One-point background suppression										

3.4.2 Reset to Factory Defaults Using the Remote Input

Eight-pulse the remote input to apply the factory defaults and return to Run mode.

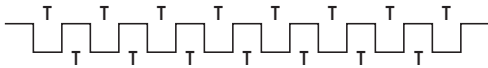

NOTE: The input wire function remains at remote teach input (**SET**).

3.5 Locking and Unlocking the Sensor Buttons

Use the lock and unlock feature to prevent unauthorized or accidental programming changes. When locked, **LOC** displays when the (SELECT) (TEACH) button is pressed. The switch point displays when (+) (LO/DO) or (-) (MODE) are pressed, but **LOC** displays if the buttons are pressed and held.

Button Instructions

To lock or unlock the sensor using the buttons, press and hold **+** and press **-** four times. **LOC** or **wLOC** flashes, depending on the previous status.

Remote Input Instructions

1. Access the remote input.

Action	Result
Four-pulse the remote input.	The sensor is ready to have the button state defined and btn displays.

2. Lock or unlock the sensor buttons.

Action	Result
Single-pulse the remote input to unlock the sensor.	wLOC displays and the sensor returns to Run mode.
Double-pulse the remote input to lock the sensor.	LOC displays and the sensor returns to Run mode.

3.6 TEACH Procedures

Use the following procedures to teach the sensor.

To cancel a TEACH procedure, press TEACH for longer than 2 seconds, or hold the remote input low for longer than 2 seconds. **Cancel** momentarily displays when a TEACH procedure is canceled.

3.6.1 Two-Point Static Background Suppression TEACH **2-PT**

Two-point TEACH sets a single switch point. The sensor sets the switch point between two taught target distances, relative to the shifted origin location.

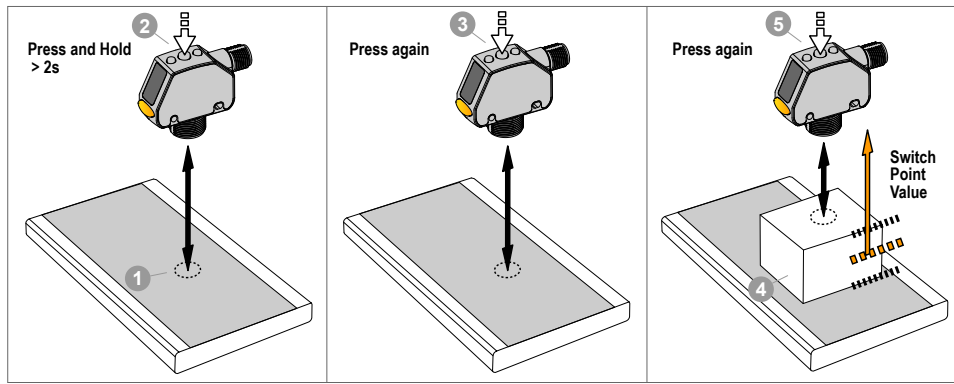

Figure 12. Two-Point Static Background Suppression (Light Operate shown)



NOTE: The sensor must be set to $tech = 2-pt$ to use the following instructions.



NOTE: To program the sensor using remote input, remote input must be enabled ($inpt = Set$).

1. Present the target.

Method	Action	Result
Push Button	Present the first target. The sensor-to-target distance must be within the sensor's range.	The target's measurement value displays.
Remote Input		

2. Start the TEACH mode.

Method	Action	Result
Push Button	Press and hold TEACH for longer than 2 seconds.	Set and $1st$ flash alternately on the display. The DYN, FGS, and BGS indicators flash.
Remote Input	No action required.	N/A

3. Teach the sensor.

Method	Action	Result
Push Button	Press TEACH to teach the target.	The sensor is taught the first target. Set , $2nd$, and the current distance measurement flash alternately on the display. The DYN, FGS, and BGS indicators flash.
Remote Input	Single-pulse the remote input. 	

4. Present the target.

Method	Action	Result
Push Button	Present the second target. The sensor-to-target distance must be within the sensor's range.	Set , $2nd$, and the distance measurement flash alternately on the display. The DYN, FGS, and BGS indicators flash.
Remote Input		

5. Teach the sensor.

Method	Action	Result
Push Button	Press TEACH to teach the target.	The new switch point flashes rapidly and the sensor returns to Run mode.
Remote Input	Single-pulse the remote input. 	

Table 2: Expected TEACH Behavior for Two-Point Static Background Suppression

See Figure 16 on page 23 for the minimum object separation.

Condition	TEACH Result	Display
Two valid distances that are greater than or equal to the horizontal minimum object separation	Sets a switch point between the two taught distances	The switch point distance flashes on the display
Two valid distances that are less than the horizontal minimum object separation	Sets a switch point in front of the furthest taught distance by the horizontal minimum object separation	bos and the switch point distance flash alternately on the display
One valid distance with one invalid TEACH point	Sets a switch point between the one taught distance and 300 mm	obut and the switch point distance flash alternately on the display
Two invalid TEACH points	Sets a switch point at 290 mm	Full and the switch point distance flash alternately on the display

3.6.2 Dynamic Background Suppression TEACH **dyn**

Dynamic TEACH sets a single switch point during machine run conditions. Dynamic TEACH is recommended for applications where a machine or process may not be stopped for teaching. The sensor takes multiple samples and the switch point is set between the minimum and the maximum sampled distances.

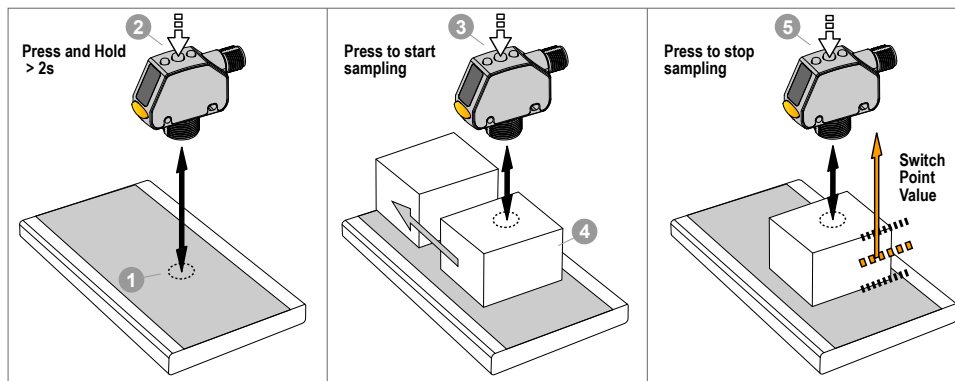

Figure 13. Dynamic Background Suppression



NOTE: The sensor must be set to **teach = dyn** to use the following instructions. The DYN indicator is amber to indicate Dynamic TEACH mode.



NOTE: To program the sensor using remote input, remote input must be enabled (**input = Set**).

1. Present the target.

Method	Action	Result
Push Button	Present the first target. The sensor-to-target distance must be within the sensor's range.	The target's measurement value displays.
Remote Input		

2. Start the TEACH mode.

Method	Action	Result
Push Button	Press and hold TEACH for longer than 2 seconds.	dyn and Set flash alternately on the display. The DYN indicator flashes.

Method	Action	Result
Remote I nput	No action required.	N/A

3. Teach the sensor.

Method	Action	Result
Push Button	Press TEACH to teach the target.	The sensor begins sampling target distance information and dyn and stop flash alternately on the display. The DYN indicator flashes.
Remote I nput	Single-pulse the remote input. 	

4. Present the targets.

Method	Action	Result
Push Button	Present additional targets. The sensor-to-target distance must be within the sensor's range.	The sensor continues to sample target distance information and dyn and stop flash alternately on the display. The DYN indicator flashes.
Remote I nput		

5. Teach the sensor.

Method	Action	Result
Push Button	Press TEACH to stop teaching the sensor.	The new switch point flashes rapidly and the sensor returns to Run mode.
Remote I nput	Single-pulse the remote input. 	



Table 3: Expected TEACH Behavior for Dynamic Background Suppression

See [Figure 16](#) on page 23 for the minimum object separation.

Condition	TEACH Result	Display
Two valid distances that are greater than or equal to the horizontal minimum object separation	Sets a switch point between the two taught distances	The switch point distance flashes on the display
Two valid distances that are less than the horizontal minimum object separation	Sets a switch point in front of the furthest taught distance by the horizontal minimum object separation	bos and the switch point distance flash alternately on the display
One valid distance with one invalid TEACH point	Sets a switch point between the one taught distance and 300 mm	obut and the switch point distance flash alternately on the display
Two invalid TEACH points	Sets a switch point at 200 mm	bos and the switch point distance flash alternately on the display

3.6.3 One-Point Window (Foreground Suppression) **FOS**

One-point window sets a window (two switch points) centered around the taught target distance. Loss of signal is treated as a detection in One-Point Window mode. The size of the taught window is the vertical minimum object separation. See [Figure 16](#) on page 23.

Manually adjust the window size from Run mode using  and .

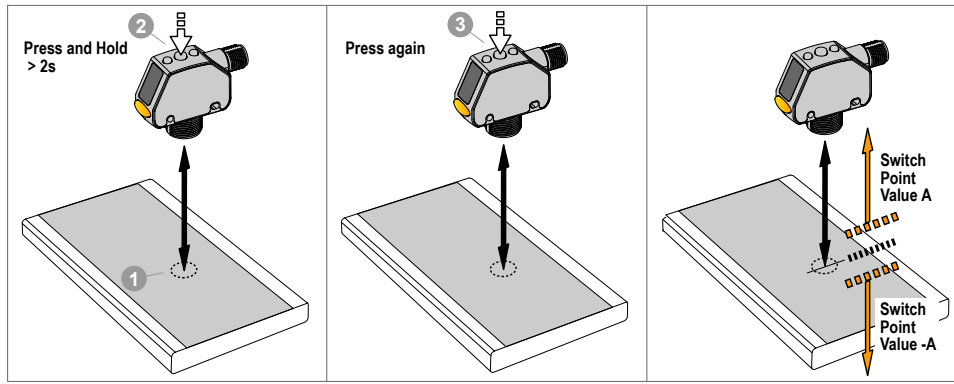

Figure 14. One-Point Window (Foreground Suppression)



NOTE: The sensor must be set to `ech = FGS` to use the following instructions. The FGS indicator is amber to indicate One-Point Window (Foreground Suppression) mode.



NOTE: To program the sensor using remote input, remote input must be enabled (`inpt = Set`).

1. Present the target.

Method	Action	Result
Push Button	Present the target. The sensor-to-target distance must be within the sensor's range.	The target's measurement value displays.
Remote Input		

2. Start the TEACH mode.

Method	Action	Result
Push Button	Press and hold TEACH for longer than 2 seconds.	<p><u>Light Operate</u></p> <p><code>Set</code> and <code>on</code> flash alternately on the display. The FGS indicator flashes.</p> <p><u>Dark Operate</u></p> <p><code>Set</code> and <code>off</code> flash alternately on the display. The FGS indicator flashes.</p>
Remote Input	No action required.	N/A

3. Teach the sensor.

Method	Action	Result
Push Button	Press TEACH to teach the target.	The ± window size flashes rapidly and the sensor returns to Run mode.
Remote Input	Single-pulse the remote input. 	

Table 4: Expected TEACH Behavior for One-Point Window (Foreground Suppression)

See Figure 16 on page 23 for the minimum object separation.

Condition	TEACH Result	Display
One valid distance	Sets a window (two switch points) centered around the taught distance. The ± window size is the vertical minimum object separation. The two switch points always stay within the specified sensing range.	The ± window size flashes on the display.
One invalid TEACH Point	Sets a window (two switch points) centered around 250 mm. The window size is ± 25 mm.	----- and the window center point distance flash alternately on the display.

3.6.4 One-Point Background Suppression b05

One-point background suppression sets a single switch point in front of the taught target distance. Objects beyond the taught switch point are ignored. The switch point is set in front of the taught target distance by the vertical minimum object separation. See [Figure 16](#) on page 23.

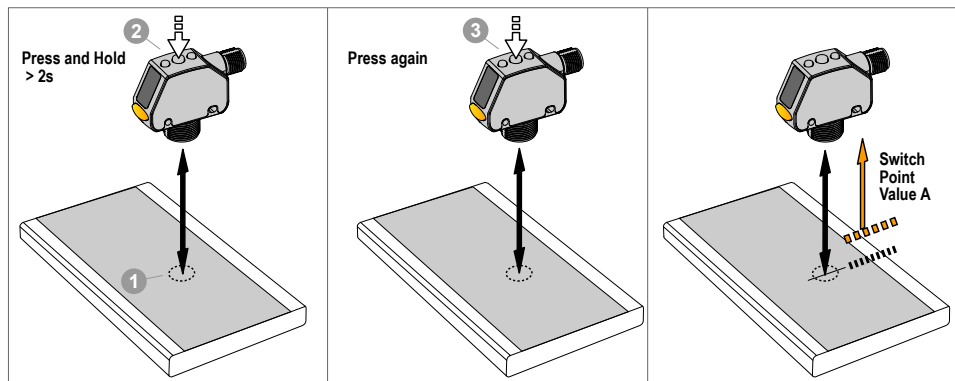

Figure 15. One-Point Background Suppression



NOTE: The sensor must be set to tch = b05 to use the following instructions. The BGS indicator is amber to indicate Background Suppression mode.



NOTE: To program the sensor using remote input, remote input must be enabled (rpt = set).

1. Present the target.

Method	Action	Result
Push Button	Present the target. The sensor-to-target distance must be within the sensor's range.	The target's measurement value displays.
Remote Input		

2. Start the TEACH mode.

Method	Action	Result
Push Button	Press and hold TEACH for longer than 2 seconds.	<p><u>Light Operate</u></p> <p>SET and OFF flash alternately on the display. The BGS indicator flashes.</p> <p><u>Dark Operate</u></p> <p>SET and ON flash alternately on the display. The BGS indicator flashes.</p>
Remote Input	No action required.	N/A

3. Teach the sensor.

Method	Action	Result
Push Button	Press TEACH to teach the target.	The new switch point flashes rapidly and the sensor returns to Run mode.
Remote Input	Single-pulse the remote input. 	

Table 5: Expected TEACH Behavior for One-Point Background Suppression

See Figure 16 on page 23 for the minimum object separation.

Condition	TEACH Result	Display
One valid distance	Sets a switch point in front of the taught distance by the vertical minimum object separation.	The switch point distance flashes on the display.
One invalid TEACH point	Sets a switch point at 200 mm.	BGS and the switch point distance flash alternately on the display.

3.7 Sync Master/Slave

Two Q4X sensors may be used together in a single sensing application. To eliminate crosstalk between the two sensors, configure one sensor to be the master and one to be the slave. In this mode, the sensors alternate taking measurements and the response speed doubles.



Important: The Master sensor and the Slave sensor must be programmed for the same Response Speed and Gain mode settings. The Master sensor and Slave sensor must share a common power source.

1. Configure the first sensor as the master; navigate: **INPT** > **MAST**.
2. Configure the second sensor as the slave; navigate: **INPT** > **SLAVE**.
3. Connect the gray (input) wires of the two sensors together.

4 Specifications

Sensing Beam

Visible red Class 1 laser, 655 nm

Supply Voltage (Vcc)

10 to 30 V dc

Power and Current Consumption, exclusive of load
< 675 mW

Sensing Range

25 mm (0.98 in) to 300 mm (11.81 in)

Output Configuration

Bipolar (1 PNP & 1 NPN) output

Output Rating

Off-state leakage current: < 5 µA at 30 V dc
PNP On-state saturation voltage: < 1.5 V dc at 100 mA load
NPN On-state saturation voltage: < 1.0 V dc at 100 mA load

Remote Input

Allowable Input Voltage Range: 0 to Vcc
Active Low (internal weak pullup—sinking current): Low
State < 2.0 V at 1 mA max.

Supply Protection Circuitry

Protected against reverse polarity, over-voltage, and transient voltages

Beam Spot Size

Table 6: Beam Spot Size

Distance (mm)	Size (Horizontal × Vertical)
25	2.6 mm × 1.0 mm
150	2.3 mm × 0.9 mm
300	2.0 mm × 0.8 mm

Temperature Effect

0.05 mm/°C at 125 mm
0.35 mm/°C at 300 mm

Excess Gain

Table 7: HIGH Excess Gain (5td Excess Gain¹)

Response Speed (ms)	Excess Gain (90% White Card at 25 mm)	Excess Gain (90% White Card at 300 mm)
1.5	200	20
3	200	20
10	1000 (500)	100 (50)
25	2500 (1000)	250 (100)
50	5000 (2500)	500 (250)

Response Speed

User selectable:

- 1.5 —1.5 milliseconds
- 3 —3 milliseconds
- 10 —10 milliseconds
- 25 —25 milliseconds
- 50 —50 milliseconds

Delay at Power Up

< 750 ms

Ambient Light Immunity

> 5,000 lux

Maximum Torque

Side mounting: 1 N·m (9 in·lbs)
Nose mounting: 20 N·m (177 in·lbs)

Connector

5-pin Euro M12 Integral Connector

Construction

Housing: 316 L stainless steel
Lens cover: PMMA acrylic
Lightpipe and display window: polysulfone

Vibration

MIL-STD-202G, Method 201A (10 to 60 Hz, 0.06 in (1.52 mm) double amplitude, 2 hours each along X, Y and Z axes), with sensor operating

Shock

MIL-STD-202G, Method 213B, Condition I (100G 6x along X, Y and Z axes, 18 total shocks), with sensor operating

Environmental Rating

IEC IP67 per IEC60529
IEC IP68 per IEC60529
IEC IP69K per DIN40050-9

Chemical Compatibility

Compatible with commonly used acidic or caustic cleaning and disinfecting chemicals used in equipment cleaning and sanitation.
Compatible with typical cutting fluids and lubricating fluids used in machining centers

Operating Conditions

Temperature: -10 °C to +55 °C (+14 °F to +131 °F)
Humidity: 35% to 95% relative humidity

Storage Temperature

-25 °C to +75 °C (-13 °F to +167 °F)

Application Note

For optimum performance, allow 10 minutes for the sensor to warm up

Certifications



Class 2 power
Ind. Cont. Eq.
3TJJ

ECOLAB® chemical compatibility pending on some models; contact Banner Engineering for details.

¹

- 5td excess gain available in 10 ms, 25 ms, and 50 ms response speeds only
- 5td excess gain provides increased noise immunity

4.1 Dimensions

All measurements are listed in millimeters (inches), unless noted otherwise.

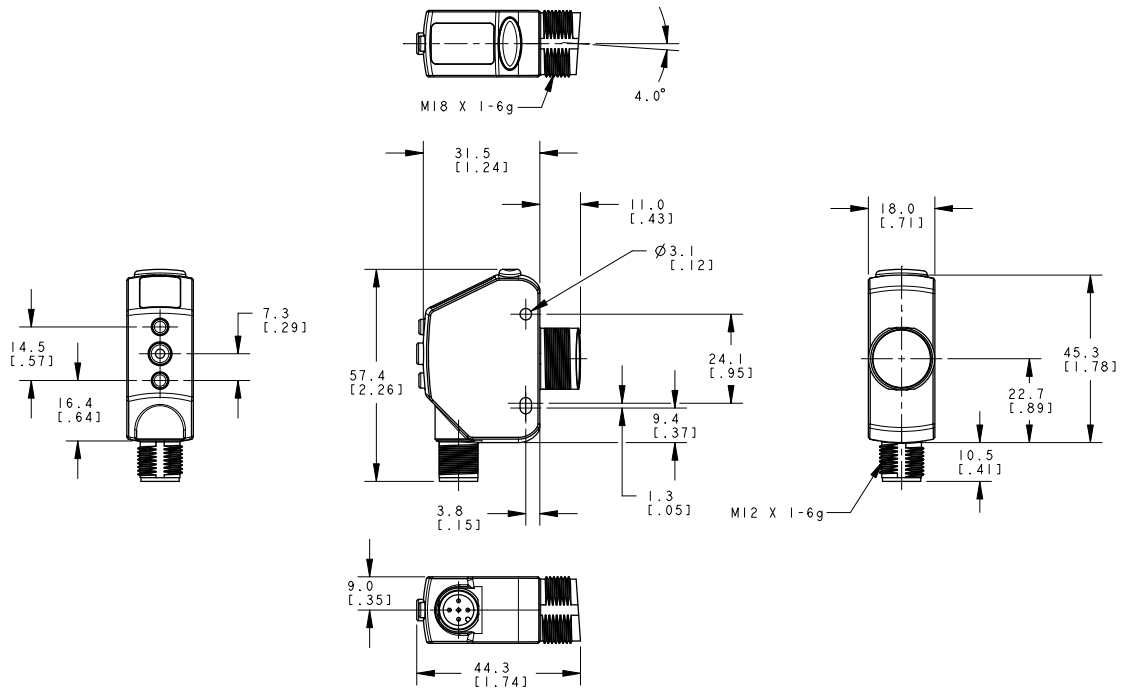

4.2 Performance Curves

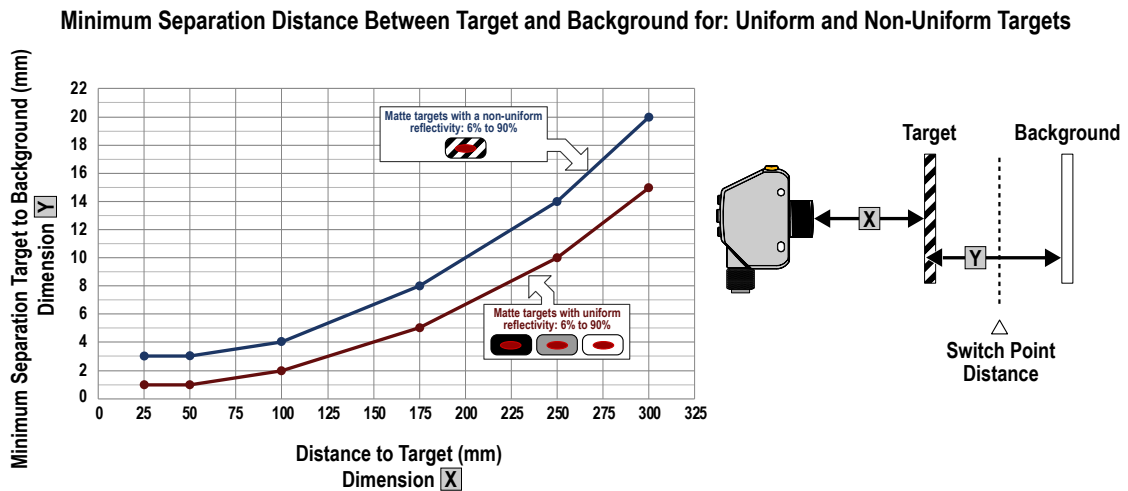

Figure 16. Minimum Object Separation Distance (90% to 6% reflectance)

5 Abbreviations

The following table describes the abbreviations used on the sensor display and in this manual.

Abbreviation	Description
----	No valid signal in range
1Sho	One-shot
1st	First
2nd	Second
2-PT	Two-point TEACH (static background suppression)
BOG	One-point background suppression
btn	Button
CanCL	Cancel
dISP	Display read
dLY	Output timing delay
DLAY	Delay
dt1	Delay timer for one-shot
dYN	Dynamic background suppression
End	End—exit the sensor menu
FAR-	Far zero reference location—the maximum range is 0 and the measurement increase as the target moves closer to the sensor
FGS	One-point window (foreground suppression)
FULL	Full range
GA in	Excess gain
HIGH	High excess gain mode
inPT	Input wire function
Loc	Lock/locked
LoFF	Laser off
MASt	Master
NEAR-	Near zero reference location—the end of the barrel is 0 and the measurement increase as the target moves further away from the sensor
objt	Object
offd	Off delay timer
ond	On delay timer
rSEt	Reset to factory defaults
SEt	Input wire = remote teach function

Abbreviation	Description
SHFT	Shift the Zero Reference Location after a TEACH
SLVE	Slave
SPd	Response speed
Std	Standard excess gain mode
Strt	Start
StoP	Stop
tch	TEACH process selection
uLoc	Unlock/unlocked
www	Saturated signal (too much light)
ZEro	Zero—select the zero reference location

6 Troubleshooting

Table 8: Error Codes

Error Code	Description	Resolution
----	No valid signal in range	Reposition the sensor or the target
UUUU	The signal is saturated (too much light)	Reposition the sensor or the target to increase the detection distance, or increase the angle of incidence between the sensor and the target
ErrE	EEPROM fault	Contact Banner Engineering to resolve
ErrL	Laser fault	Contact Banner Engineering to resolve
ErrO	Output short-circuited	Check the wiring for an electrical short circuit and to ensure that the wiring is correct
ErrS	System fault	Contact Banner Engineering to resolve

7 Accessories

7.1 Cordsets

All measurements are listed in millimeters, unless noted otherwise.

5-Pin Threaded M12/Euro-Style Cordsets (Single Ended)				
Model	Length	Style	Dimensions	Pinout (Female)
MQDC1-501.5	0.50 m (1.5 ft)	Straight		
MQDC1-506	1.83 m (6 ft)			
MQDC1-515	4.57 m (15 ft)			
MQDC1-530	9.14 m (30 ft)			
MQDC1-506RA	1.83 m (6 ft)	Right-Angle		
MQDC1-515RA	4.57 m (15 ft)			
MQDC1-530RA	9.14 m (30 ft)			

5-Pin Threaded M12/Euro-Style Cordsets—Washdown Stainless Steel

Cable: PVC jacket and over-mold, EPDM o-ring, 316L coupling nut
 Environmental Rating: IEC IP69K

5-Pin Threaded M12/Euro-Style Cordsets—Washdown Stainless Steel				
Model	Length	Style	Dimensions	Pinout (Female)
MQDC-WDSS-0506	1.83 m (6 ft)	Straight		
MQDC-WDSS-0515	4.57 m (15 ft)			
MQDC-WDSS-0530	9.14 m (30 ft)			

7.2 Brackets

All measurements are listed in millimeters, unless noted otherwise.

SMBQ4X..

- Swivel bracket with tilt and pan movement for precision adjustment
- Easy sensor mounting to extruded rail T-slots
- Metric and inch size bolts available
- Side mounting of some sensors with the 3 mm screws included with the sensor

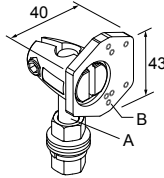

B = 7 × M3 × 0.5

Model	Bolt Thread (A)
SMBQ4XFA	3/8 - 16 × 2 1/4 in
SMBQ4XFAM10	M10 - 1.5 × 50
SMBQ4XFAM12	n/a; no bolt included. Mounts directly to 12 mm (1/2 in) rods

SMB18FA..

- Swivel bracket with tilt and pan movement for precision adjustment
- Easy sensor mounting to extruded rail T-slots
- Metric and inch size bolts available
- 18 mm sensor mounting hole

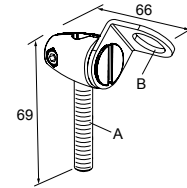

Hole size: B=ø 18.1

Model	Bolt Thread (A)
SMB18FA	3/8 - 16 × 2 in
SMB18FAM10	M10 - 1.5 × 50
SMB18FAM12	n/a; no bolt included. Mounts directly to 12 mm (1/2 in) rods

SMB18A

- Right-angle mounting bracket with a curved slot for versatile orientation
- 12-ga. stainless steel
- 18 mm sensor mounting hole
- Clearance for M4 (#8) hardware

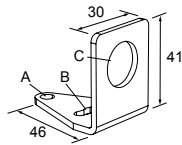

Hole center spacing: A to B = 24.2
Hole size: A = ø 4.6, B = 17.0 × 4.6, C = ø 18.5

7.3 Aperture Kits

APG18S

Kit with glass lens to protect plastic sensor lens from chemical environments and weld splatter damage.



Used with S18, M18, T18, TM18, and Q4X

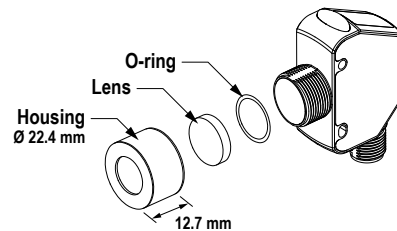

Additional Information

- Borosilicate glass window protects the PMMA window from weld splatter and chemicals
- Adds 4.8 mm to the length of the threaded barrel
- Reduces excess gain by 30%; increase the response time to restore excess gain

8 Contact Us

Corporate Headquarters

Address:
Banner Engineering Corporate
9714 Tenth Avenue North
Minneapolis, Minnesota 55441, USA

Phone: +1 763 544 3164
Website: www.bannerengineering.com

Europe

Address:
Banner Engineering EMEA
Park Lane Culliganlaan 2F
Diegem B-1831, Belgium

Phone: +32 (0)2 456 0780
Website: www.bannerengineering.com/eu
Email: mail@bannerengineering.com

Turkey

Address:
Banner Engineering Turkey
Barbaros Mah. Uphill Court Towers A Blok D:49
34746 Batı Ataşehir İstanbul Türkiye

Phone: +90 216 688 8282
Website: www.bannerengineering.com.tr
Email: turkey@bannerengineering.com.tr

India

Address:
Banner Engineering India Pune Head Quarters
Office No. 1001, 10th Floor Sai Capital, Opp. ICC Senapati Bapat Road
Pune 411016, India

Phone: +91 (0) 206 640 5624
Website: www.bannerengineering.co.in
Email: salesindia@bannerengineering.com

Mexico

Address:
Banner Engineering de Mexico Monterrey Head Office
Edificio VAO Av. David Alfaro Siqueiros No.103 Col. Valle Oriente C.P.66269
San Pedro Garza Garcia, Nuevo Leon, Mexico

Phone: +52 81 8363 2714 or 01 800 BANNERE (toll free)
Website: www.bannerengineering.com.mx
Email: mexico@bannerengineering.com

Brazil

Address:
Banner do Brasil
Rua Barão de Teffé nº 1000, sala 54
Campos Eliseos, Jundiaí - SP, CEP.: 13208-761, Brasil

Phone: +1 763 544 3164
Website: www.bannerengineering.com.br
Email: brasil@bannerengineering.com

China

Address:
Banner Engineering Shanghai Rep Office
Xinlian Scientific Research Building Level 12, Building 2
1535 Hongmei Road, Shanghai 200233, China

Phone: +86 212 422 6888
Website: www.bannerengineering.com.cn
Email: sensors@bannerengineering.com.cn

Japan

Address:
Banner Engineering Japan
Cent-Urban Building 305 3-23-15 Nishi-Nakajima Yodogawa-Ku
Osaka 532-0011, Japan

Phone: +81 (0)6 6309 0411
Website: www.bannerengineering.co.jp
Email: mail@bannerengineering.co.jp

Taiwan

Address:
Banner Engineering Taiwan
8F-2, No. 308 Section 1, Neihu Road
Taipei 114, Taiwan

Phone: +886 (0)2 8751 9966
Website: www.bannerengineering.com.tw
Email: info@bannerengineering.com.tw

South Korea

Address:
Banner Engineering Korea
8th Fl, CM Bldg, 32-7, Songpa-Dong Songpa-Gu
Seoul 138-849, South Korea

Phone: +82 (0)2 417 0285
Website: www.bannerengineering.co.kr
Email: info@bannerengineering.co.kr

9 Banner Engineering Corp Limited Warranty

Banner Engineering Corp. warrants its products to be free from defects in material and workmanship for one year following the date of shipment. Banner Engineering Corp. will repair or replace, free of charge, any product of its manufacture which, at the time it is returned to the factory, is found to have been defective during the warranty period. This warranty does not cover damage or liability for misuse, abuse, or the improper application or installation of the Banner product.

THIS LIMITED WARRANTY IS EXCLUSIVE AND IN LIEU OF ALL OTHER WARRANTIES WHETHER EXPRESS OR IMPLIED (INCLUDING, WITHOUT LIMITATION, ANY WARRANTY OF MERCHANTABILITY OR FITNESS FOR A PARTICULAR PURPOSE), AND WHETHER ARISING UNDER COURSE OF PERFORMANCE, COURSE OF DEALING OR TRADE USAGE.

This Warranty is exclusive and limited to repair or, at the discretion of Banner Engineering Corp., replacement. IN NO EVENT SHALL BANNER ENGINEERING CORP. BE LIABLE TO BUYER OR ANY OTHER PERSON OR ENTITY FOR ANY EXTRA COSTS, EXPENSES, LOSSES, LOSS OF PROFITS, OR ANY INCIDENTAL, CONSEQUENTIAL OR SPECIAL DAMAGES RESULTING FROM ANY PRODUCT DEFECT OR FROM THE USE OR INABILITY TO USE THE PRODUCT, WHETHER ARISING IN CONTRACT OR WARRANTY, STATUTE, TORT, STRICT LIABILITY, NEGLIGENCE, OR OTHERWISE.

Banner Engineering Corp. reserves the right to change, modify or improve the design of the product without assuming any obligations or liabilities relating to any product previously manufactured by Banner Engineering Corp.