



November 2014

# MMBD1401A / MMBD1403A / MMBD1404A / MMBD1405A High-Voltage General-Purpose Diode

## Descriptions

Sourced from process 2V.

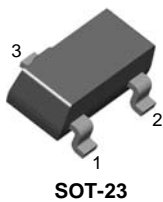

Connection Diagram

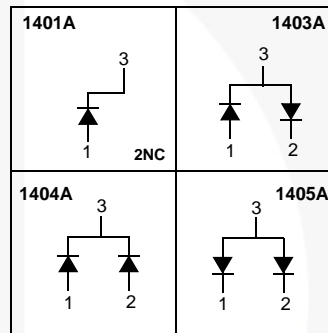

## Ordering Information

Part Number	Top Mark	Package	Packing Method
MMBD1401A	A29	SOT-23 3L	Tape and Reel
MMBD1403A	A32	SOT-23 3L	Tape and Reel
MMBD1404A	A33	SOT-23 3L	Tape and Reel
MMBD1405A	A34	SOT-23 3L	Tape and Reel

MMBD1401A / MMBD1403A / MMBD1404A / MMBD1405A — High-Voltage General-Purpose Diode

## Absolute Maximum Ratings<sup>(1), (2)</sup>

Stresses exceeding the absolute maximum ratings may damage the device. The device may not function or be operable above the recommended operating conditions and stressing the parts to these levels is not recommended. In addition, extended exposure to stresses above the recommended operating conditions may affect device reliability. The absolute maximum ratings are stress ratings only. Values are at  $T_A = 25^\circ\text{C}$  unless otherwise noted.

Symbol	Parameter	Value	Unit
$W_{IV}$	Working Inverse Voltage	175	V
$I_O$	Average Rectified Current	200	mA
$I_F$	DC Forward Current	600	mA
$i_f$	Recurrent Peak Forward Current	700	mA
$i_{f(\text{surge})}$	Non-Repetitive Peak Forward Surge Current	Pulse Width = 1.0 second	1.0
		Pulse Width = 1.0 microsecond	2.0
$T_{STG}$	Storage Temperature Range	-55 to +150	$^\circ\text{C}$
$T_J$	Operating Junction Temperature	150	$^\circ\text{C}$

### Notes:

- These ratings are based on a maximum junction temperature of  $150^\circ\text{C}$ .
- These are steady-state limits. Fairchild Semiconductor should be consulted on applications involving pulsed or low-duty-cycle operations.

## Thermal Characteristics<sup>(3)</sup>

Values are at  $T_A = 25^\circ\text{C}$  unless otherwise noted.

Symbol	Parameter	Max.	Unit
$P_D$	Power Dissipation	350	mW
	Derate above $25^\circ\text{C}$	2.8	mW/ $^\circ\text{C}$
$R_{\theta JA}$	Thermal Resistance, Junction-to-Ambient	357	$^\circ\text{C}/\text{W}$

### Note:

- Device is mounted on glass epoxy PCB 1.6 inch x 1.6 inch x 0.06 inch, mounting pad for the collector lead minimum  $0.93 \text{ in}^2$ .

## Electrical Characteristics

Values are at  $T_A = 25^\circ\text{C}$  unless otherwise noted.

Symbol	Parameter	Conditions	Min.	Max.	Unit
$B_V$	Breakdown Voltage	$I_R = 100 \mu\text{A}$	250		V
$I_R$	Reverse Current	$V_R = 120 \text{ V}$		40	nA
		$V_R = 175 \text{ V}$		100	nA
$V_F$	Forward Voltage	$I_F = 10 \text{ mA}$		800	mV
		$I_F = 50 \text{ mA}$	760	920	mV
		$I_F = 200 \text{ mA}$		1.1	V
		$I_F = 300 \text{ mA}$		1.25	V
$C_O$	Diode Capacitance	$V_R = 0, f = 1.0 \text{ MHz}$		2.0	pF
$T_{RR}$	Reverse Recovery Time	$I_F = I_R = 30 \text{ mA}$ , $I_{RR} = 1.0 \text{ mA}, R_L = 100 \Omega$		50	nS

## Typical Performance Characteristics

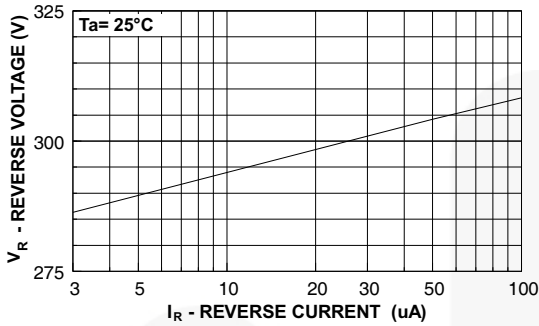

Figure 1. Reverse Voltage vs. Reverse Current  
BV - 1.0 to 100  $\mu$ A

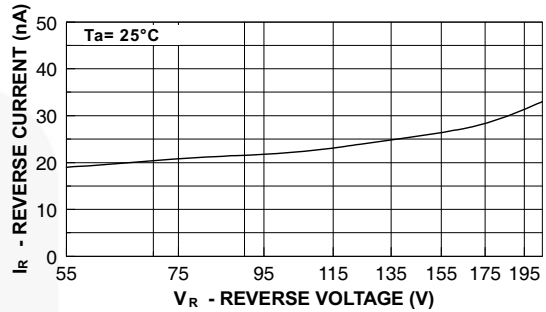

Figure 2. Reverse Current vs. Reverse Voltage  
 $I_R$  - 55 to 205 V

GENERAL RULE: The Reverse Current of a diode will approximately double for every ten (10) Degree C increase in Temperature

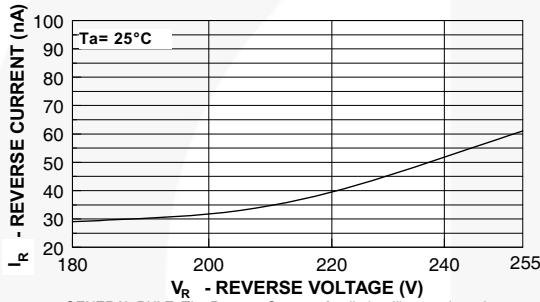

Figure 3. Reverse Current vs. Reverse Voltage  
 $I_R$  - 180 to 255 V

GENERAL RULE: The Reverse Current of a diode will approximately double for every ten Degree C increase in Temperature

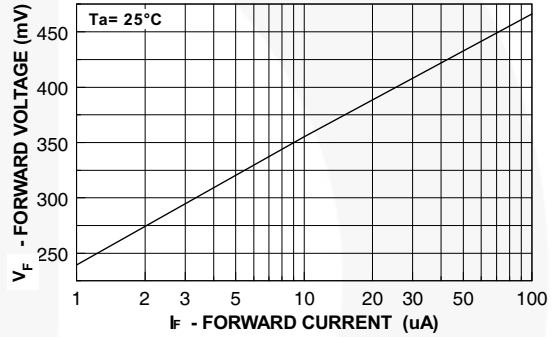

Figure 4. Forward Voltage vs. Forward Current  
 $V_F$  - 1.0 to 100  $\mu$ A

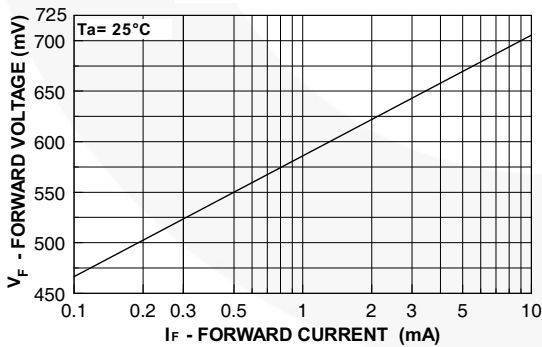

Figure 5. Forward Voltage vs. Forward Current  
 $V_F$  - 0.1 to 10 mA

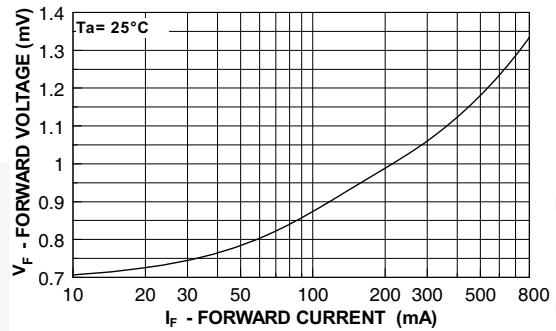

Figure 6. Forward Voltage vs. Forward Current  
 $V_F$  - 10 to 800 mA

Typical Performance Characteristics (Continued)

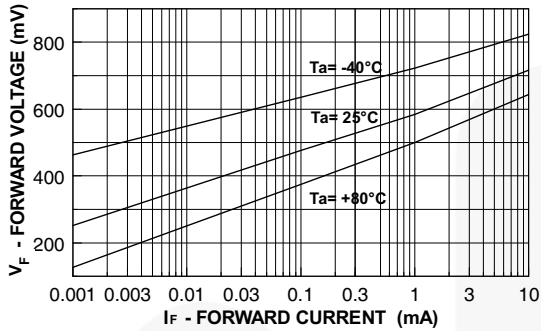

Figure 7. Forward Voltage vs. Ambient Temperature  
 $V_F$  - 1.0  $\mu$ A - 10 mA (- 40 to +80°C)

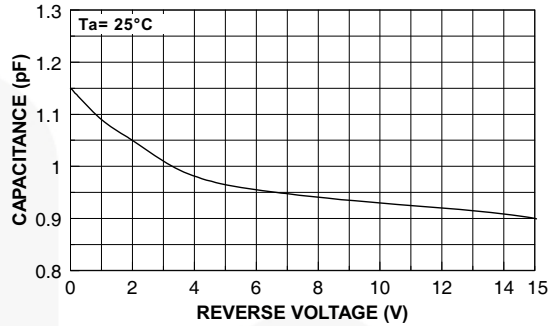

Figure 8. Capacitance vs. Reverse Voltage

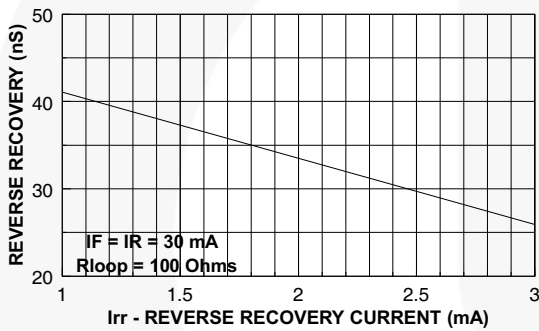

Figure 9. Reverse Recovery Time vs. Reverse Recovery Current ( $I_{rr}$ )

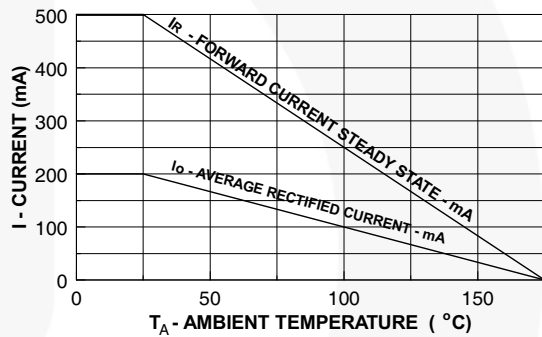

Figure 10. Average Rectified Current ( $I_O$ ) and Forward Current ( $I_F$ ) vs. Ambient Temperature ( $T_A$ )

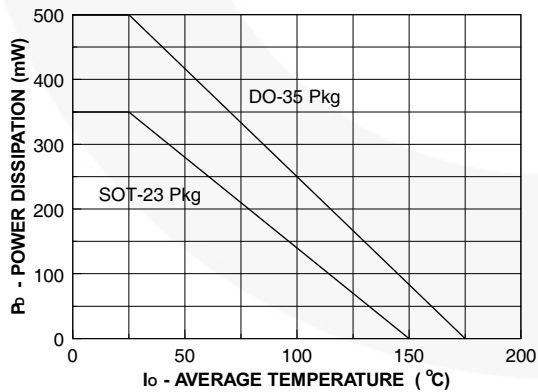
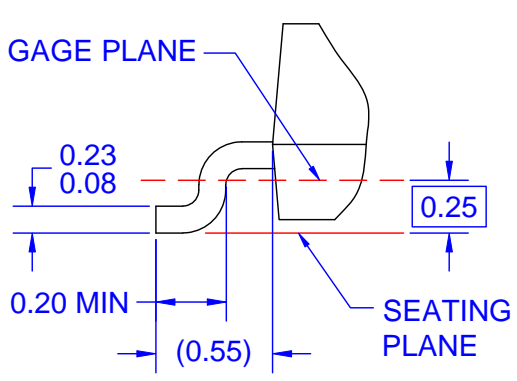
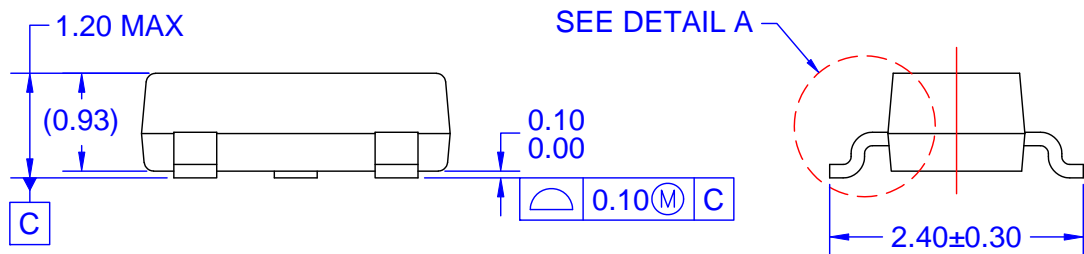
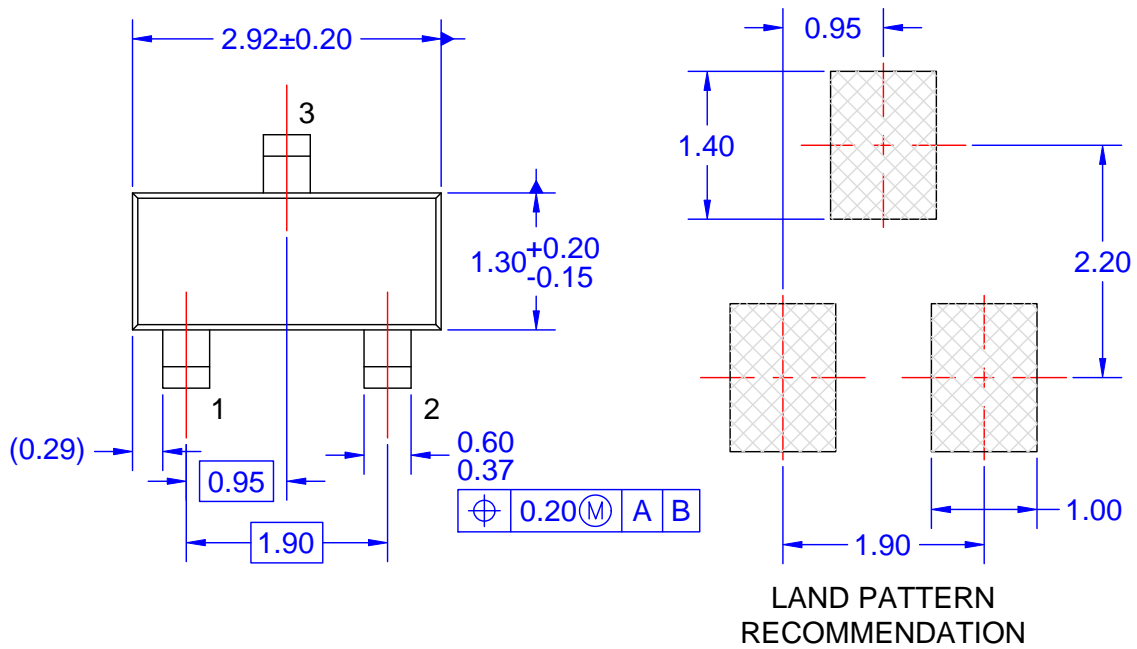

Figure 11. Power Derating Curve



**DETAIL A**  
SCALE: 2X





NOTES: UNLESS OTHERWISE SPECIFIED

- A) REFERENCE JEDEC REGISTRATION TO-236, VARIATION AB, ISSUE H.
- B) ALL DIMENSIONS ARE IN MILLIMETERS.
- C) DIMENSIONS ARE INCLUSIVE OF BURRS, MOLD FLASH AND TIE BAR EXTRUSIONS.
- D) DIMENSIONING AND TOLERANCING PER ASME Y14.5M - 1994.
- E) DRAWING FILE NAME: MA03DREV10



### TRADEMARKS

The following includes registered and unregistered trademarks and service marks, owned by Fairchild Semiconductor and/or its global subsidiaries, and is not intended to be an exhaustive list of all such trademarks.

AccuPower™	F-PFS™	OPTOPLANAR®	
AttitudeEngine™	FRFET®		TinyBoost®
Awinda®	Global Power Resource <sup>SM</sup>	PowerTrench®	TinyBuck®
AX-CAP®*	GreenBridge™	PowerXS™	TinyCalc™
BitSiC™	Green FPS™	Programmable Active Droop™	TinyLogic®
Build it Now™	Green FPS™ e-Series™	QFET®	TINYOPTO™
CorePLUS™	Gmax™	QS™	TinyPower™
CorePOWER™	GTO™	Quiet Series™	TinyPWM™
CROSSVOLT™	IntelliMAX™	RapidConfigure™	TinyWire™
CTL™	ISOPLANAR™		TranSiC™
Current Transfer Logic™	Making Small Speakers Sound Louder and Better™	Saving our world, 1mW/W/kW at a time™	TriFault Detect™
DEUXPEED®	MegaBuck™	SignalWise™	TRUECURRENT®*
Dual Cool™	MICROCOUPLER™	SmartMax™	μSerDes™
EcoSPARK®	MicroFET™	SMART START™	
EfficientMax™	MicroPak™	Solutions for Your Success™	UHC®
ESBC™	MicroPak2™	SPM®	Ultra FRFET™
	MillerDrive™	STEALTH™	UniFET™
Fairchild®	MotionMax™	SuperFET®	VCM™
Fairchild Semiconductor®	MotionGrid®	SuperSOT™-3	VisualMax™
FACT Quiet Series™	MTI®	SuperSOT™-6	VoltagePlus™
FACT®	MTX®	SuperSOT™-8	XS™
FAST®	MVN®	SupreMOS®	Xsens™
FastvCore™	mWSaver®	SyncFET™	仙童™
FETBench™	OptoHiT™	Sync-Lock™	
FPS™	OPTOLOGIC®		

\* Trademarks of System General Corporation, used under license by Fairchild Semiconductor.

### DISCLAIMER

FAIRCHILD SEMICONDUCTOR RESERVES THE RIGHT TO MAKE CHANGES WITHOUT FURTHER NOTICE TO ANY PRODUCTS HEREIN TO IMPROVE RELIABILITY, FUNCTION, OR DESIGN. TO OBTAIN THE LATEST, MOST UP-TO-DATE DATASHEET AND PRODUCT INFORMATION, VISIT OUR WEBSITE AT [HTTP://WWW.FAIRCHILDSEMI.COM](http://www.fairchildsemi.com). FAIRCHILD DOES NOT ASSUME ANY LIABILITY ARISING OUT OF THE APPLICATION OR USE OF ANY PRODUCT OR CIRCUIT DESCRIBED HEREIN; NEITHER DOES IT CONVEY ANY LICENSE UNDER ITS PATENT RIGHTS, NOR THE RIGHTS OF OTHERS. THESE SPECIFICATIONS DO NOT EXPAND THE TERMS OF FAIRCHILD'S WORLDWIDE TERMS AND CONDITIONS, SPECIFICALLY THE WARRANTY THEREIN, WHICH COVERS THESE PRODUCTS.

### LIFE SUPPORT POLICY

FAIRCHILD'S PRODUCTS ARE NOT AUTHORIZED FOR USE AS CRITICAL COMPONENTS IN LIFE SUPPORT DEVICES OR SYSTEMS WITHOUT THE EXPRESS WRITTEN APPROVAL OF FAIRCHILD SEMICONDUCTOR CORPORATION.

As used herein:

- Life support devices or systems are devices or systems which, (a) are intended for surgical implant into the body or (b) support or sustain life, and (c) whose failure to perform when properly used in accordance with instructions for use provided in the labeling, can be reasonably expected to result in a significant injury of the user.
- A critical component in any component of a life support, device, or system whose failure to perform can be reasonably expected to cause the failure of the life support device or system, or to affect its safety or effectiveness.

### ANTI-COUNTERFEITING POLICY

Fairchild Semiconductor Corporation's Anti-Counterfeiting Policy. Fairchild's Anti-Counterfeiting Policy is also stated on our external website, [www.fairchildsemi.com](http://www.fairchildsemi.com), under Sales Support.

Counterfeiting of semiconductor parts is a growing problem in the industry. All manufacturers of semiconductor products are experiencing counterfeiting of their parts. Customers who inadvertently purchase counterfeit parts experience many problems such as loss of brand reputation, substandard performance, failed applications, and increased cost of production and manufacturing delays. Fairchild is taking strong measures to protect ourselves and our customers from the proliferation of counterfeit parts. Fairchild strongly encourages customers to purchase Fairchild parts either directly from Fairchild or from Authorized Fairchild Distributors who are listed by country on our web page cited above. Products customers buy either from Fairchild directly or from Authorized Fairchild Distributors are genuine parts, have full traceability, meet Fairchild's quality standards for handling and storage and provide access to Fairchild's full range of up-to-date technical and product information. Fairchild and our Authorized Distributors will stand behind all warranties and will appropriately address any warranty issues that may arise. Fairchild will not provide any warranty coverage or other assistance for parts bought from Unauthorized Sources. Fairchild is committed to combat this global problem and encourage our customers to do their part in stopping this practice by buying direct or from authorized distributors.

### PRODUCT STATUS DEFINITIONS

#### Definition of Terms

Datasheet Identification	Product Status	Definition
Advance Information	Formative / In Design	Datasheet contains the design specifications for product development. Specifications may change in any manner without notice.
Preliminary	First Production	Datasheet contains preliminary data; supplementary data will be published at a later date. Fairchild Semiconductor reserves the right to make changes at any time without notice to improve design.
No Identification Needed	Full Production	Datasheet contains final specifications. Fairchild Semiconductor reserves the right to make changes at any time without notice to improve the design.
Obsolete	Not In Production	Datasheet contains specifications on a product that is discontinued by Fairchild Semiconductor. The datasheet is for reference information only.

Rev. I73