

Operating and
Service Guide

Keysight Truevolt Series Digital Multimeters

Notice: This document contains references to Agilent Technologies. Agilent's former Test and Measurement business has become Keysight Technologies. For more information, go to www.keysight.com.



Safety and Regulatory Information	12
Notices	12
Manual Information	12
Software Revision	12
Warranty	12
Technology Licenses	12
Restricted Rights Legend	13
Safety Notices	14
Safety Symbols	14
Safety Information	15
General	15
Measurement Limits	17
Input Terminal Measurement Limits	19
Sense Terminal Measurement Limits	19
IEC Measurement Category II	20
Keysight 34138A Test Lead Set	20
Test Lead Ratings	20
Operation	20
Maintenance	20
Declaration of Conformity	21
Welcome	22
Introductory Information	22
User Information	22
SCPI Programming Reference	23
Service and Repair	23
Performance Verification	23
Calibration Procedures	23
Introduction to the Instrument	24
Instrument at a Glance	24
Display – Easily display, save and document your measurement results	24
Measurements – Keysight’s Truevolt measurement performance with modern I/O accessibility	24
Programming Language	24
Front Panel at a Glance	25
Front Panel Keys	25
Rear Panel at a Glance	26
Models and Options	27
Options Installed at Factory	27
Options Installed by Distributor or End Customer	27
Remote Interface Configuration	29
Connectivity Software	29
GPIB Configuration	29
LAN Configuration	30
Web Interface	33
LAN Configuration Procedure	34
More about IP Addresses and Dot Notation	35
Firmware Update	36

Contacting Keysight Technologies	37
Quick Start	38
Prepare Instrument for Use	38
Setting the AC Mains Line Voltage Selector and Fuse Installation	39
Connect Power and I/O Cables	41
Adjust the Carrying Handle	42
Use Built-in Help System	43
View the help information for a front panel key	43
View the list of help topics and use interactive demos	44
View the list of recent instrument errors.	45
View the help information for displayed messages.	45
Rack Mount the Instrument	46
Removing the Handle and Bumpers	46
Rack Mounting a Single Instrument	46
Rack Mounting Instruments Side-by-Side	46
Sliding Support Shelf	47
Features and Functions	48
Continuous, Data Log, and Digitize Modes	49
Continuous Mode	49
Data Log Mode	49
Digitize Mode	49
Data Log and Digitize Mode Default Settings	50
Additional Data Log Default Settings	50
Additional Digitize Default Settings	51
Front Panel Menu Reference	52
[Acquire] key	56
[Math] key	56
[Display] key	56
[Utility] key	57
Measurements	58
DC Voltage	59
AC Voltage	62
DC Current	64
AC Current	66
Resistance	68
Temperature (34460A and 34461A)	71
Temperature (34465A and 34470A)	73
Capacitance	78
Continuity	79
Diode	80
Frequency and Period	81
Data Logging	83
Digitizing	88
Level Triggering	93
Secondary Measurements	95
Triggering and Readings	97

Instrument trigger model	97
Trigger delay and multiple samples	99
Storing and clearing readings	100
Probe Hold	102
Math - Introduction	103
Math - Null	104
Math - dB/dBm Scaling	105
Math - Scaling	107
Math - Smoothing	110
Math - Statistics	111
Math - Limits	112
Display - Introduction	116
Selecting the Display	116
Number	118
Bar Meter	123
Trend Chart (Continuous Measurement Mode)	126
Trend Chart (Digitize and Data Log Modes)	129
Histogram	135
Utility Menu - Introduction	140
Utility - Autocalibration	141
Utility - Store and Recall State and Preference Files	143
Utility Menu - Manage Files	145
Utility Menu - I/O Configuration	147
Utility Menu - Test/Admin	150
Utility Menu - System Setup	152
Web Interface	155
Welcome Page	155
Instrument Monitor and Control Page	156
Configuration Page	160
Help	161
Measurement Tutorial	162
Measurement Considerations	163
Metrology	164
DC Measurement Considerations	165
Thermal EMF Errors	165
Loading Errors (DC Voltage)	165
Noise Rejection	166
Rejecting Power-Line Noise Voltages	166
Common Mode Rejection (CMR)	166
Noise Caused by Magnetic Loops	166
Noise Caused by Ground Loops	167
Resistance Measurement Considerations	168
Removing Test Lead Resistance Errors	168
Minimizing Power Dissipation Effects	169
Errors in High Resistance Measurements	169
True RMS AC Measurements	170
True RMS Accuracy and High-Frequency Signal Content	171

Estimating High-Frequency (Out-of-Band) Error	172
Other Primary Measurement Functions	174
Frequency and Period Measurement Errors	174
DC Current	174
Temperature Measurements	175
NULL Reading	176
Autozero On/Off	176
Making High-Speed AC Measurements	176
Making High-Speed DC and Resistance Measurements	177
Capacitance	178
Capacitance Measurement Considerations	179
Digitizing Measurements	180
The Sampling Rate	180
Level Triggering	181
About Digitize Mode	181
Data Log and Digitizing Local Remote Interaction	183
Data Log Mode	184
Data Log Mode Features	184
Data Logging and the Trend Chart Display	188
Data Log and Digitizing Local Remote Interaction	189
Level Triggering	190
About Level Trigger	190
Other Sources of Measurement Error	192
Settling Time Effects	192
Loading Errors (AC volts)	192
Measurements Below Full Scale	193
High-Voltage Self-Heating Errors	193
AC Current Measurement Errors (Burden Voltage)	193
Low-Level Measurement Errors	194
Common Mode Errors	194
Leakage Current Errors	195
Unnecessary Signal Errors	195
How Sample Rate/Interval is Determined	196
SCPI Programming Reference	197
Related Information	197
IO Libraries and Instrument Drivers	197
Keysight Truevolt Series Documentation	197
Web Interface	197
Introduction to the SCPI Language	198
Syntax Conventions	198
Command Separators	199
Using the MIN, MAX and DEF Parameters	199
Querying Parameter Settings	199
SCPI Command Terminators	200
IEEE-488.2 Common Commands	200
SCPI Parameter Types	200
Using Device Clear	202

Commands by Subsystem	202
ABORT	204
FETCh?	205
INITiate[:IMMediate]	206
OUTPut:TRIGger:SLOPe {POSitive NEGative}OUTPut:TRIGger:SLOPe?	207
R? [<max_readings>]	208
READ?	209
ROUTE:TERMinals?	210
TEST:ALL?	211
UNIT:TEMPerature {C F K}UNIT:TEMPerature?	212
CALCulate Subsystem Introduction	213
CALibration Subsystem	240
CONFigure Subsystem	246
DATA Subsystem	259
DISPlay Subsystem	262
FORMat Subsystem	264
HCOPy Subsystem	266
IEEE 488.2 Common Commands	267
LXI Subsystem	280
MEASure Subsystem	283
MMEMory Subsystem - General Purpose File Management	294
MMEMory Subsystem - STATe and PREFerence Files	299
MMEMory Subsystem - Data Transfer Commands	304
SAMPlE Subsystem	309
SENSE Subsystem Introduction	316
STATus Subsystem	389
SYSTem Subsystem - General Purpose Commands	395
SYSTem Subsystem - I/O Configuration	407
SYSTem Subsystem LOCK Commands	421
SYSTem Subsystem LICense Commands	424
TRIGger Subsystem	429
Command Quick Reference	436
Configuration Commands	436
Measurement Commands	436
Measurement Configuration Commands	436
Sample Commands	443
Triggering Commands	443
Calculation (Math) Commands	444
Reading Memory Commands	446
Calibration Commands	447
State Storage and Preferences Commands	447
General Purpose File Management Commands	448
Data Transfer Commands	449
IEEE-488 Commands	449
Format Subsystem	450
System-Related Commands	450
Interface Locking Commands	451

License Management Commands	451
Interface Configuration Commands	452
Status System Commands	453
Range, Resolution and Integration Time (shown in Aperture and NPLCs)	454
Resolution and Integration Time for DC Measurements	456
Automatic Trigger Delays	457
DC Voltage Default Delays	457
DC Current Default Delays	457
Resistance (2-wire) Default Delays	458
Resistance (4-wire) Default Delays	458
AC Voltage Default Delays	458
AC Current Default Delays	459
Frequency and Period	459
VM Comp Output (BNC)	460
SCPI Error Messages	461
Command Errors (-100...)	463
Execution Errors (-200...)	465
Device-Specific Errors (-300...)	468
Query Errors (-400...)	468
Network Errors (+100...)	468
Instrument Errors (+200...)	469
Miscellaneous Errors (+300... and +500..)	469
Licensing and Self-test Errors (+600...)	470
Calibration Errors (+700...)	472
Miscellaneous Errors (+800...)	474
Power-On and Reset State	475
Factory Default Settings	475
Service and Repair	478
Types of Service Available	478
Obtaining Repair Service (Worldwide)	478
Repackaging for Shipment	479
Cleaning	479
Electrostatic Discharge (ESD) Precautions	479
Power Supplies	480
Troubleshooting	483
Troubleshooting Procedure	484
Self-Test Procedures	487
Power-On Self-Test	487
Full Self-Test	487
User Replaceable Parts	488
Disassembly	489
Tools Required	489
General Disassembly Procedure	490
Battery Replacement	493
Tools Required	493
Procedure	494
3 A and 10 A Current Path Fuse Replacement	495

Tools Required	495
Testing the Fuses	496
Internal Fuse Replacement Procedure	497
Installing the Optional GPIB Interface	498
Tools Required	498
Installation Procedure	498
Retain GPIB Cover Plate	498
Security Code Override	500
Which Procedure Should I Use?	500
Procedure A: For Firmware Revision Ending in 02, or Greater	501
Procedure B: For Firmware Revision Ending in 01	503
Performance Verification	504
Quick Performance Check	505
Performance Verification Tests	506
Recommended Test Equipment	506
Zero Offset Verification	507
DC Volts and DC Current Gain Verification	511
Frequency Accuracy Verification	516
AC Voltage and AC Current Verification	517
High Current Verification	522
Capacitance Verification (Optional Verification Test)	523
Calibration Adjustment Procedures	524
Calibration Procedures	525
Input Connections	526
Test Considerations	526
Recommended Test Equipment	527
Calibration Adjustment Process	528
Gain Calibration Adjustment Overview	529
Gain and Flatness Calibration Adjustment Overview	530
Entering Calibration Values and Storing Calibration Constants	531
Calibration Security	532
Calibration Message	533
Calibration Count	534
Aborting a Calibration in Progress	535
Security Code Override	536
34460A and 34461A Calibration Procedures	541
ADC and Zero Calibration	542
AC Voltage Low Frequency Gain and Flatness Calibration	544
AC Voltage Gain and Flatness Calibration	545
AC Current Gain and Flatness Calibration	546
AC Zero Calibration	547
Frequency Accuracy Calibration	548
DC Voltage Gain Calibration	549
Ohms Gain Calibration	550
DC Current Gain Calibration	551
AC Current 10 A Gain Calibration	552

DC Current 10 A Gain Calibration	553
Capacitance Offset Calibration (Optional)	554
Finishing Calibration	555
34465A and 34470A Calibration Procedures	556
ADC and Zero Calibration	557
AC Voltage Low Frequency Gain and Flatness Calibration	559
AC Voltage Gain and Flatness Calibration	560
AC Current Gain and Flatness Calibration	561
AC Zero Calibration	562
Frequency Accuracy Calibration	563
DC Voltage Gain Calibration	564
Ohms Gain Calibration	565
DC Current Gain Calibration	566
DC High Voltage Gain Calibration	567
AC Current 10 A Gain Calibration	568
DC Current 10 A Gain Calibration	569
Capacitance Offset Calibration (Optional)	570
Finishing Calibration	571
Index	572

Safety and Regulatory Information

Notices

© Keysight Technologies, Inc. 2013 - 2015

No part of this manual may be reproduced in any form or by any means (including electronic storage and retrieval or translation into a foreign language) without prior agreement and written consent from Keysight Technologies, Inc. as governed by United States and international copyright laws.

Manual Information

Part Number: 34460-90901, Edition 2, (February, 2015)

Keysight Technologies, Inc.
900 S. Taft Ave.
Loveland, CO 80537 USA

Software Revision

For the latest firmware, go to the product page at www.keysight.com/find/truevolt.

The latest product documentation is available at www.keysight.com/find/truevolt-doc. For documentation for mobile devices, see www.keysight.com/find/truevolt-mobilehelp.

A portion of the software in this product is licensed under terms of the General Public License Version 2 ("GPLv2"). The text of the license and source code can be found at www.keysight.com/find/GPLV2.

This product uses Microsoft Windows CE. Keysight highly recommends that all Windows-based computers connected to Windows CE instruments use current anti-virus software. For more information, see www.keysight.com/find/truevolt.

Warranty

The material contained in this document is provided "as is," and is subject to being changed, without notice, in future editions. Further, to the maximum extent permitted by applicable law, Keysight disclaims all warranties, either express or implied, with regard to this manual and any information contained herein, including but not limited to the implied warranties of merchantability and fitness for a particular purpose. Keysight shall not be liable for errors or for incidental or consequential damages in connection with the furnishing, use, or performance of this document or of any information contained herein. Should Keysight and the user have a separate written agreement with warranty terms covering the material in this document that conflict with these terms, the warranty terms in the separate agreement shall control.

Technology Licenses

The hardware and/or software described in this document are furnished under a license and may be used or copied only in accordance with the terms of such license.

Restricted Rights Legend

U.S. Government Restricted Rights. Software and technical data rights granted to the federal government include only those rights customarily provided to end user customers. Keysight provides this customary commercial license in Software and technical data pursuant to FAR 12.211 (Technical Data) and 12.212 (Computer Software) and, for the Department of Defense, DFARS 252.227-7015 (Technical Data – Commercial Items) and DFARS 227.7202-3 (Rights in Commercial Computer Software or Computer Software Documentation).

Safety Notices

CAUTION

A CAUTION notice denotes a hazard. It calls attention to an operating procedure, practice, or the like that, if not correctly performed or adhered to, could result in damage to the product or loss of important data. Do not proceed beyond a CAUTION notice until the indicated conditions are fully understood and met.

WARNING

A WARNING notice denotes a hazard. It calls attention to an operating procedure, practice, or the like that, if not correctly performed or adhered to, could result in personal injury or death. Do not proceed beyond a WARNING notice until the indicated conditions are fully understood and met.

Safety Symbols



Alternating current



Frame or chassis terminal



Standby supply. Unit is not completely disconnected from AC mains power when switch is off.



WARNING Risk of electric shock



CAUTION Refer to accompanying documents



The CE mark is a registered trademark of the European Community.



The CSA mark with the 'c' and 'us' subscript indicates the instrument is certified to the applicable Canadian and United States of America standards respectively.

CAT II (300V) IEC Measurement Category II. Inputs may be connected to AC mains power (up to 300 VAC) under Category II overvoltage conditions.



This product is marked with the ACMA RCM mark for compliance in Australia / New Zealand. A copy of the Manufacturer's Australia Declaration of Conformity for this instrument can be obtained by contacting your local Keysight Technologies Sales Representative.

ISM 1-A This text indicates that the instrument is an Industrial Scientific and Medical Group 1 Class A product (CISPR 11, Clause 4).

ICES/NMB- This ISM device complies with Canadian ICES-001.

001

Cet appareil ISM est conforme à la norme NMB-001 du Canada.



This product complies with the WEEE Directive (2002/96/EC) marking equipment. The affixed product label indicates that you must not discard this electrical/electronic product in domestic household waste.

To return unwanted products, contact your local Keysight office, or see www.keysight.com/environment/product/ for more information.



This equipment is Class A suitable for professional use and is for use in electromagnetic environments outside of the home.

이 기기는 업무용 (A 급) 전자파적합기기로서 판매자 또는 사용자는 이 점을 주의하시기 바라며, 가정외의 지역에서 사용하는 것을 목적으로 합니다.



Contains one or more of the 6 hazardous substances above the maximum concentration value (MCV), 40 Year EPUP.

Safety Information

General

Do not use this product in any manner not specified by the manufacturer. The protective features of this product may be impaired if it is used in a manner not specified in the operation instructions. Do not install substitute parts or perform any unauthorized modification to the product. Return the product to a Keysight Technologies Sales and Service Office for service and repair to ensure that safety features are maintained.

WARNING Product Grounding

The instrument is a Class 1 product and is provided with a grounding-type power cord set. The instrument chassis and cover are connected to the instrument electrical ground to minimize shock hazard. The ground pin of the cord set plug must be firmly connected to the electrical ground (safety ground) terminal at the power outlet. Any interruption of the protective earth (grounding) conductor or disconnection of the protective earth terminal will cause a potential shock hazard that could result in personal injury or death.

WARNING Cleaning

To prevent electrical shock, disconnect the instrument from AC mains power and disconnect all test leads before cleaning. Clean the outside of the instrument using a soft, lint-free, cloth slightly dampened with water. Do not use detergent or solvents. Do not attempt to clean internally. If needed, contact a Keysight Technologies Sales and Service office to arrange for proper cleaning to ensure that safety features and performance are maintained.

WARNING AC Power Cord

Removal of the AC power cord is the disconnect method to remove power from the instrument. Be sure to allow for adequate access to the power cord to permit disconnection from AC power. Use only the Keysight specified power cord for the country of use or one with equivalent ratings.

WARNING Do Not Remove Instrument Cover

Only qualified, service-trained personnel should remove the cover from the instrument. Service: Unplug instrument from wall outlet, remove power cord, and remove all probes from all terminals before servicing.

WARNING AC Mains Power Line Fuse

For continued protection against fire, replace the line fuse only with fuses of the specified type and rating. The instrument must be disconnected from AC mains power, and all measurement terminals must be disconnected before changing the fuse.

WARNING Current Measurement Protection Fuse

For continued protection against fire, replace current-protection fuses only with fuses of the specified type and rating. The instrument must be disconnected from AC mains power, and all measurement terminals must be disconnected before changing the fuse.

WARNING Front/Rear Switch

Do not change the position of the Front/Rear switch on the front panel while signals are present on either the front or rear set of terminals. The switch is not intended as an active multiplexer. Switching while current or high voltage is present may cause instrument damage and lead to the risk of electric shock.

WARNING Do Not Operate in an Explosive Atmosphere

This instrument is not designed to be operated in an explosive environment. The instrument enclosure complies with the IP 20 rating.

WARNING In Case of Damage

An instrument that appears damaged or defective should be made inoperative and secured against unintended operation until qualified service personnel can repair it.

WARNING Self-Test

Before measuring any hazardous voltage or current, remove all test leads to the instrument, run the TEST:ALL? query from the remote interface, and read the result to verify that the instrument is performing properly.

The TEST:ALL? query is a self-test that returns +0 if the instrument passes and +1 if the instrument fails. You can also perform this query from the front panel by pressing [Shift] > [Utility] > Test/Admin > Self Test > Full Test. If this self-test fails, make sure that the instrument is repaired and passes the complete self-test before continuing.

WARNING Measuring AC Power Mains

The HI, LO, and current input terminals may be connected to AC mains power in IEC Category II installations for line voltages up to 300 VAC. To avoid the danger of electric shock, do not connect the inputs to AC mains power for line voltages above 300 VAC. See [IEC Measurement Category II](#) for further information.

WARNING Measuring Current with A Current Transformer

If a current transformer is used for measuring current, you must use a current transformer with internal secondary protection. Using a current transformer without protection may result in a hazardous voltage resulting in a severe shock or death. In addition, this may cause damage to the instrument.

WARNING Crest Factor

Exceeding the crest factor limit may result in an inaccurate or lower reading display. Do not exceed the crest factor limit to avoid instrument damage and risk of electric shock. The crest factor limit is listed in the product data sheet at www.keysight.com/find/truevolt-doc.

WARNING Measurement Limits

To avoid instrument damage and the risk of electric shock, do not exceed any of the Measurement Limits defined in the following section.

CAUTION This product complies with EN/IEC 61326-2-1, for sensitive test and measurement equipment:

When subjected to transient radiated and/or conducted electromagnetic phenomena, the product may have temporary loss of function or performance which is self-recovering. Recovery may take longer than 10 seconds.

When subjected to continuously present electromagnetic phenomena, some degradation of performance may occur.

CAUTION Unless otherwise noted in the specifications, this instrument or system is intended for indoor use in an installation category II, pollution degree 2 environment per IEC 61010-1 and 664 respectively. It is designed to operate at a maximum relative humidity of 5% to 80% at 40 °C or less (non-condensing). This instrument or system is designed to operate at altitudes up to 3000 meters, and at temperatures between 0 and 55 °C.

Measurement Limits

The Truevolt Series DMMs provide protection circuitry to prevent damage to the instrument and to protect against the danger of electric shock, provided the Measurement Limits are not exceeded. To ensure safe operation of the instrument, do not exceed the Measurement Limits shown on the front and rear panel, and defined as follows:

34460A Front Panel Terminal Area

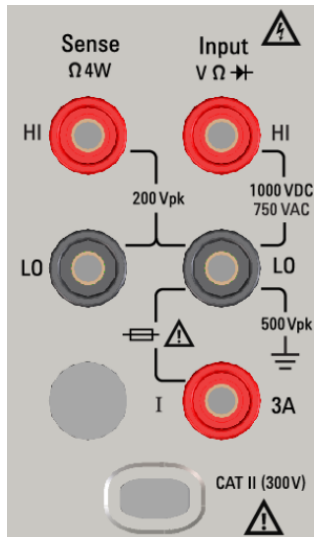

34461A, 34465A, 34470A Front Panel Terminal Area

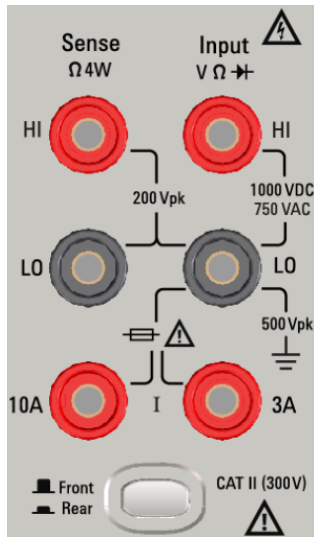

34461A, 34465A, 34470A Rear Panel Terminal Area

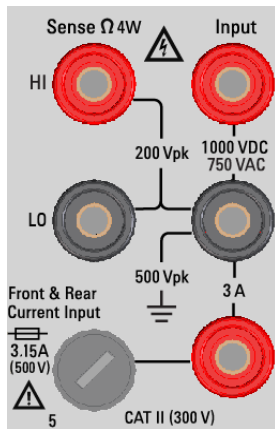

NOTE

For the 34461A, 34465A, and 34470A, the Front/Rear switch selects the terminal set to be used. DO NOT operate this switch while signals are present on the front or rear terminals.

The user-replaceable 3 A current-protection fuse is on the rear panel. There are 3 A and 10 A (34461A, 34465A and 34470A) current-protection fuses located inside the unit. Contact your Keysight Sales and Service Center or refer to product service documentation for replacement instructions.

To maintain protection, replace fuses only with [fuses of the specified type and rating](#).

Input Terminal Measurement Limits

Measurement Limits are defined for the input terminals:

Main Input (HI and LO) Terminals. The HI and LO input terminals are used for voltage, resistance, frequency (period), capacitance, and diode test measurements. Two Measurement Limits are defined for these terminals:

- **HI to LO Measurement Limit.** The Measurement Limit from HI to LO (Input terminals) is 1000 VDC or 750 VAC, which is also the maximum voltage measurement. This limit can also be expressed as 1000 Vpk maximum.
- **LO to Ground Measurement Limit.** The LO input terminal can safely "float" a maximum of 500 Vpk relative to ground, where ground is defined as the Protective Earth Conductor in the AC mains power cord connected to the instrument.

As implied by the above limits, the Measurement Limit for the HI input terminal is a maximum of 1500 Vpk relative to ground when LO is at its maximum of 500 Vpk relative to ground.

Current Input Terminal. The current input ("I") terminal has a Measurement Limit of 3 A or 10 A (DC or AC) between the "I" terminal (3 A or 10 A) and the LO input terminal. Note that the current input terminals will always be at approximately the same voltage as the LO terminal, unless a current protection fuse is open. The 10 A terminal is not available on the 34460A.

Sense Terminal Measurement Limits

The HI and LO sense terminals are used for DCV ratio measurements and four-wire resistance and temperature measurements. The Measurement Limit is 200 Vpk for all of the terminal pairings: LO sense to LO input, HI sense to LO input, and HI sense to LO sense.

NOTE

The 200 Vpk limit on the sense terminals is the Measurement Limit. Operational voltages in resistance measurements are much lower – up to ± 12 V in normal operation.

IEC Measurement Category II

To protect against the danger of electric shock, the Keysight Truevolt Series DMM protects the user from AC mains power overvoltage events. When measuring AC mains, the HI and LO input terminals may be connected to AC mains power up to 300 VAC under Measurement Category II conditions as defined below.

IEC Measurement Category II includes electrical devices connected to AC mains power at an outlet on a branch circuit. Such devices include most small appliances, test equipment, and other devices that plug into a branch outlet or socket. The instrument may be used to make measurements with the HI and LO inputs connected to AC mains power in such devices, or to the branch outlet itself (up to 300 VAC). However, the instrument may not be used with its HI and LO inputs connected to AC mains power in permanently installed electrical devices such as the main circuit-breaker panel, sub-panel disconnect boxes, or permanently wired motors. Such devices and circuits are subject to overvoltages that may exceed the instrument's protection capabilities.

NOTE Voltages above 300 VAC may be measured only in circuits that are isolated from AC mains power. However, transient overvoltages are also present on circuits that are isolated from AC mains power. The instrument is designed to safely withstand occasional transient overvoltages up to 1500 Vpk when measuring voltages greater than 300 VAC. Do not use this equipment to measure circuits where transient overvoltages could exceed this level.

Keysight 34138A Test Lead Set

The Keysight 34138A Test Lead Set, described below, is compatible with the Truevolt Series DMMs.

Test Lead Ratings

- Test Leads - 1000V, 15A
- Fine Tip Probe Attachments - 300V
- 3A Mini Grabber Attachment - 300V, 3A
- SMT Grabber Attachments - 300V, 3A

Operation

The Fine Tip, Mini Grabber, and SMT Grabber attachments plug onto the probe end of the Test Leads.

Maintenance

If any portion of the Test Lead Set is worn or damaged, do not use. Replace with a new Keysight 34138A Test Lead Set.

WARNING If the Test Lead Set is used in a manner not specified by Keysight Technologies, the protection provided by the Test Lead Set may be impaired. Also, do not use a damaged or worn Test Lead Set. Personal injury or death may result.

Declaration of Conformity

Declarations of Conformity for this product and for other Keysight products may be downloaded from the Keysight Regulatory Web site:

<http://regulations.products.keysight.com/DoC/search.htm>

Welcome

Welcome

This Operating and Service Guide contains information for using, programming, and servicing the Keysight Truevolt Series Digital Multimeters (DMMs). If you have feedback on this document, please go to www.keysight.com/find/truevolt-docfeedback.

Introductory Information

[Safety and Regulatory Information](#)

[Models and Options](#)

[Quick Start](#)

[Contacting Keysight Technologies](#)

[Introduction to the Instrument](#)

User Information

[Front Panel Menu Reference](#)

[Features and Functions](#)

[Remote Interface Configuration](#)

[LAN Configuration Procedure](#)

[Web Interface](#)

[Measurements](#)

[Triggering and Readings](#)

[Probe Hold](#)

[Math](#)

[Display](#)

[Utility Menu](#)

[Measurement Tutorial](#)

SCPI Programming Reference

[Welcome to SCPI](#)

[Introduction to the SCPI Language](#)

[Commands by Subsystem](#)

[Command Quick Reference](#)

[Range, Resolution, and NPLC](#)

[Resolution Table](#)

[VM Comp Output](#)

[SCPI Error Messages](#)

[Power-On and Reset State](#)

Service and Repair

[Service and Repair](#)

[Disassembly](#)

[Troubleshooting](#)

[Power Supplies](#)

[Self-Test Procedures](#)

[Battery Replacement](#)

[Installing the Optional GPIB Interface](#)

[User Replaceable Parts](#)

Performance Verification

[Performance Verification](#)

Calibration Procedures

[Calibration Procedures](#)

[34460A and 34461A Calibration Procedures](#)

[34465A and 34470A Calibration Procedures](#)

[Firmware Update](#)

Introduction to the Instrument

The Keysight Technologies 34460A/61A/65A instruments are 6½-digit digital multimeters (DMMs); the 34470A is a 7½-digit DMM.

[Instrument at a Glance](#)

[Front Panel at a Glance](#)

[Rear Panel at a Glance](#)

[Models and Options](#)

[Contacting Keysight Technologies](#)

Instrument at a Glance

The instrument's combination of bench-top and system features make it a versatile solution now and in the future. The instrument can make a wide range of accurate and flexible measurements.

Display – Easily display, save and document your measurement results

- High usability with an intuitive, menu driven user interface
- Histogram, trend chart (not available on the 34460A), meter, and numeric views on a high-resolution color display
- USB, LAN (optional on 34460A), and optional GPIB interface
- Drag and drop, driverless USB connectivity

Measurements – Keysight's *Truevolt* measurement performance with modern I/O accessibility

- Patented, metrology-level performance that serves as the foundation for all measurements

Programming Language

- SCPI (Standard Commands for Programmable Instruments) programming language

Front Panel at a Glance

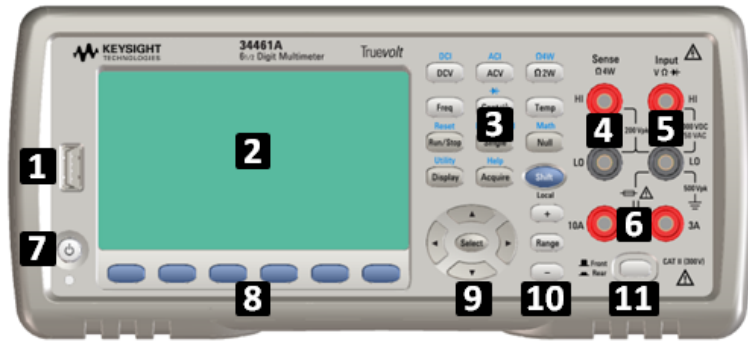

Item	Description
1	USB Port
2	Display
3	Measurement Configuration and Instrument Operation Keys
4	HI and LO Sense Terminals
5	HI and LO Input Terminals
6	AC/DC Current Input Terminals (10 A terminal not available on 34460A)
7	On/Standby Switch
8	Softkeys
9	Cursor Navigation Keypad
10	Range Selection Keys
11	Front/Rear Switch (34461A/65A/70A only)

Front Panel Keys

NOTE

Some of the front panel keys have text above them. This indicates that the key has a function that you can access by pressing and releasing **[Shift]** before pressing the key. For example, if you press and release **[Shift]** before pressing **[Display]**, you will access the **[Utility]** function:



Rear Panel at a Glance



Item	Description
1	HI and LO Sense Terminals (34461A/65A/70A only)
2	HI and LO Input Terminals (34461A/65A/70A only)
3	Fan Vents (34461A/65A/70A only)
4	GPIB Connector (optional)
5	AC Mains Line Voltage Selector and Fuse Access
6	3 A Current Terminal Fuse
7	3 A Current Terminal (34461A/65A/70A only)
8	Voltmeter Measurement Complete Output
9	External Trigger Input
10	Local Area Network (LAN) Connector
11	USB Interface Connector
12	Instrument Cable Lock
13	Chassis Ground Screw
14	AC Mains Input

Models and Options

The available Truevolt Digital Multimeter (DMM) models are:

- 34460A - 6½-digit Basic DMM
- 34461A - 6½-digit 34401A Replacement DMM
- 34465A - 6½-digit DMM
- 34470A - 7½-digit DMM

The factory-installed options and the options that can be installed by you or a distributor are listed in the tables below. You can determine the installed options from the instrument's front panel by pressing **[Shift] > [Help] . About**.

Options Installed at Factory

34460A	34461A	34465A	34470A	Description
34460A-LAN	*N/A - Standard	*N/A - Standard	*N/A - Standard	Rear panel LAN/LXI web interface, external triggering for 34460A.
34460A-SEC	34461A-SEC	34465A-SEC	34470A-SEC	NISPOM and file security for Truevolt series DMMs license.
34460A-GPB	34461A-GPB	34465A-GPB	34470A-GPB	User-installable GPIB interface module
34460A-ACC	*N/A - Standard	*N/A - Standard	*N/A - Standard	Accessory kit for 34460A - Test Leads, USB Cable
34460A-Z54	34461A-Z54	34465A-Z54	34470A-Z54	Certificate of calibration – ANSI/NCSL Z540.3-2006, printed
*N/A	*N/A	34465A-DIG	34470A-DIG	Digitizing and advanced triggering license
*N/A	*N/A	34465A-MEM	34470A-MEM	2 MB memory license

Options Installed by Distributor or End Customer

Product Number	34460A	34461A	34465A	34470A	Description
3446LANU	Option	*N/A - Standard	*N/A - Standard	*N/A - Standard	Enable rear panel LAN/LXI web interface, external triggering for 34460A
3446SECU	Option	Option	Option	Option	NISPOM and file security for Truevolt series DMMs license.
3446GPBU	Option	Option	Option	Option	User-installable GPIB interface module
3446ACCU	Option	*N/A - Standard	*N/A - Standard	*N/A - Standard	Accessory kit for 34460A - Test Leads, USB Cable
3446DIGU	*N/A	*N/A	Option	Option	Digitizing and advanced triggering for 34465A and 34470A Truevolt DMMs license
3446MEMU	*N/A	*N/A	Option	Option	2 MB memory for 34465A and 34470A Truevolt DMMs license

Introduction to the Instrument

**N/A = Not Applicable.*

Remote Interface Configuration

NOTE

If you have the security option installed on your instrument, the instrument must be unsecured with the security code to perform many of these actions.

The instrument supports remote interface communication over three interfaces: GPIB (optional), USB, and LAN (optional on 34460A). All three are "live" at power up when the instrument ships from the factory.

- **GPIB Interface:** Set the instrument's GPIB address and connect to your PC using a GPIB cable.
- **USB Interface:** Use the rear-panel USB connector to communicate with your PC. For details, see [USB Settings](#).
- **LAN Interface:** By default, DHCP is on, which may enable communication over LAN. The acronym DHCP stands for Dynamic Host Configuration Protocol, a protocol for assigning dynamic IP addresses to networked devices. With dynamic addressing, a device can have a different IP address every time it connects to the network.

Connectivity Software

- The instrument ships with the **Keysight Automation-Ready CD**. This CD contains Keysight IO Libraries Suite software, which must be installed to enable remote-interface operations. The CD auto-starts and provides information on installing the software. Also includes *Keysight Technologies USB/LAN/GPIB Connectivity Guide*, which contains additional information.

GPIB Configuration

Each device on the GPIB (IEEE-488) interface must have a unique whole number address between 0 and 30. The instrument ships with a default address of 10, and the GPIB address is displayed at power-on.

- This setting is non-volatile; it will not be changed by power cycling or [*RST](#) or [SYSTem:PRESet](#).
- Your computer's GPIB interface card address must not conflict with any instrument on the interface bus.
- **Front Panel:** Press **[Utility] > I/O Config > GPIB Settings**. From this menu, you can set the GPIB address and turn GPIB on or off. After making changes, you must cycle power on the instrument for the change to take effect.
- **SCPI:**
[SYSTem:COMMunicate:GPIB:ADDRess <address>](#)
[SYSTem:COMMunicate:ENABle {ON|1|OFF|0},GPIB](#)

LAN Configuration

The following sections describe the primary front panel LAN configuration functions, including SCPI commands where applicable. Some LAN configuration functions can be performed only via SCPI. See [SYSTEM Subsystem - I/O Configuration](#) for all LAN configuration commands, and see [LAN Configuration Procedure](#) to configure the LAN via the front panel.

NOTE

Some LAN settings require you to cycle instrument power to activate them. The instrument briefly displays a message when this is the case, so watch the screen closely as you change LAN settings.

Resetting the LAN

You can clear the Web Interface password, turn DHCP on, and restart the LAN at any time:

- **Front Panel:[Utility] > I/O Config > LAN Reset**

The message "Performing LAN Reset" is displayed while the LAN is reset.

- **SCPI: LXI:RESet**

DHCP On/Off

DHCP (Dynamic Host Configuration Protocol) can automatically assign a dynamic IP address to a LAN device. This is typically the easiest way to configure the instrument for LAN.

- This setting is non-volatile; it will not be changed by power cycling or [*RST](#) or [SYSTEM:PRESet](#).
- **Front Panel:[Utility] > I/O Config > LAN Settings > Modify Settings**
Then set the first softkey to DHCP to use DHCP to automatically assign an IP address.
- **SCPI: [SYSTEM:COMMunicate:LAN:DHCP {ON|1|OFF|0}](#)**
- If you change this parameter, you must either press the **Apply Changes** softkey (front panel) or send [SYSTEM:COMMunicate:LAN:UPDate](#) (remote interface) for the change to take effect.

To manually set an IP address, Subnet Mask, or Default Gateway, turn DHCP off, then change the IP setup as described below.

IP Address

You can enter a static IP address for the instrument as a four-byte integer expressed in dot notation. Each byte is a decimal value, with no leading zeros (for example, 169.254.2.20).

- If DHCP is on, it attempts to assign an IP address to the instrument. If it fails, Auto-IP attempts to assign an IP address to the instrument.
- Contact your LAN administrator to obtain an IP address.
- This setting is non-volatile; it will not be changed by power cycling or ***RST** or **SYSTem:PRESet**.
- **Front Panel:[Utility] > I/O Config > LAN Settings > Modify Settings**
Then set the first softkey to **Manual** and press **IP Address** to enter a new IP address.
- **SCPI: SYSTem:COMMunicate:LAN:IPADdress "<address>"**
- If you change this parameter, you must either press the **Apply Changes** softkey (front panel) or send **SYSTem:COMMunicate:LAN:UPDate** (remote interface) for the change to take effect.

Subnet Mask

Subnetting allows the LAN administrator to subdivide a network to simplify administration and minimize network traffic. The subnet mask indicates the portion of the host address used to indicate the subnet.

- Contact your LAN administrator for details.
- This setting is non-volatile; it will not be changed by power cycling or ***RST** or **SYSTem:PRESet**.
- **Front Panel:[Utility] > I/O Config > LAN Settings > Modify Settings**
Then set the first softkey to **Manual** and press **Subnet Mask** to enter a new subnet mask with the arrow keys (for example: 255.255.0.0).
- **SCPI: SYSTem:COMMunicate:LAN:SMASk "<mask>"**
- If you change this parameter, you must either press the **Apply Changes** softkey (front panel) or send **SYSTem:COMMunicate:LAN:UPDate** (remote interface) for the change to take effect.

Default Gateway

A gateway is a network device that connects networks. The default gateway setting is the IP address of such a device.

- You need not set a gateway address if using DHCP.
- Contact your LAN administrator for details.
- This setting is non-volatile; it will not be changed by power cycling or ***RST** or **SYSTem:PRESet**.
- **Front Panel:[Utility] > I/O Config > LAN Settings > Modify Settings**
Then set the first softkey to **Manual** and press **More** and **Gateway**. Then set the appropriate gateway address using the arrow keys.
- **SCPI: SYSTem:COMMunicate:LAN:GATeway "<address>"**
- If you change this parameter, you must either press the **Apply Changes** softkey (front panel) or send **SYSTem:COMMunicate:LAN:UPDate** (remote interface) for the change to take effect.

Hostname

A hostname is the host portion of the domain name, which is translated into an IP address.

- The instrument receives a unique hostname at the factory, but you may change it. The hostname must be unique on the LAN.
- The name must start with letter; other characters can be an upper or lower case letters, numeric digits, or dashes ("-").
- This setting is non-volatile; it will not be changed by power cycling or ***RST** or **SYSTem:PRESet**.
- **Front Panel:[Utility] > I/O Config > LAN Settings > Modify Settings**
Then press **Host Name** and enter the hostname with the front panel arrow keys.
- **SCPI: SYSTem:COMMunicate:LAN:HOSTname "<name>"**
- If you change this parameter, you must either press the **Apply Changes** softkey (front panel) or send **SYSTem:COMMunicate:LAN:UPDate** (remote interface) for the change to take effect.

Domain Name

A domain name is a registered Internet name that gets translated into an IP address. You cannot set it from the front panel or SCPI.

DNS Server

DNS (Domain Name Service) is an Internet service that translates domain names into IP addresses. The DNS server address is the IP address of a server that performs this service.

- Normally, DHCP discovers DNS address information; you only need to change this if DHCP is unused or not functional. Contact your LAN administrator for details.
- This setting is non-volatile; it will not be changed by power cycling or ***RST** or **SYSTem:PRESet**.
- **Front Panel:[Utility] > I/O Config > LAN Settings > Modify Settings**
Then set the first softkey to **Manual** and press **More** and **Primary DNS** or **Second DNS** to enter a DNS address using the front panel arrow keys.
- **SCPI: SYSTem:COMMunicate:LAN:DNS[1|2] "<address>"**
- If you change this parameter, you must either press the **Apply Changes** softkey (front panel) or send **SYSTem:COMMunicate:LAN:UPDate** (remote interface) for the change to take effect.

Current Configuration (LAN)

- Press **[Utility] > I/O Config > LAN Settings** to view the MAC address and current LAN configuration. There is no equivalent SCPI command.
- If the instrument goes into remote, all LAN changes will be canceled and the display will go to a different screen. Re-selecting the LAN Settings page will display the new settings if a LAN restart took place.

Web Interface

The instrument includes a built-in Web Interface for remote instrument access and control over LAN via a Web browser. For details, see [Web Interface](#).

LAN Configuration Procedure

There are several parameters that you might need to set to establish network communication using the LAN interface. Primarily, you will need to establish an IP address. You might need to contact your network administrator for help in establishing communication with the LAN interface.

NOTE If your instrument has the secure (SEC) option, the instrument must be unsecured to change most LAN settings.

1. Press [Utility] > I/O Config > LAN Settings.
2. You can select **Modify Settings** to change the LAN settings, or you can turn LAN Services on and off or restore the LAN settings to default values.

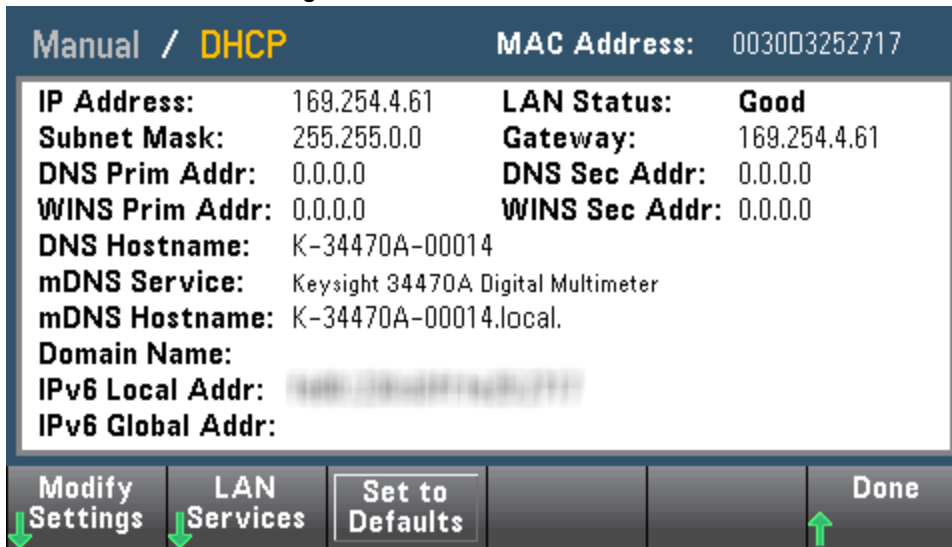

3. To change settings, press **Modify Settings**. To access most items on this screen, use the first softkey to switch from **DHCP** to **Manual**. With DHCP on, an IP address will automatically be set by DHCP (Dynamic Host Configuration Protocol) when you connect the instrument to the network, provided the DHCP server is found and is able to do so. DHCP also automatically deals with the subnet mask, gateway address, DNS, WINS, and domain name, if required. This is typically the easiest way to establish LAN communication for your instrument; all you need to do is leave DHCP on. Contact your LAN administrator for details.
4. **Establish an "IP Setup."**
If you are not using DHCP (the first softkey is set to **Manual**), you must establish an IP setup, including an IP address, and possibly a subnet mask and gateway address. The **IP Address** and **Subnet Mask** buttons are on the main screen, and you press **More** to configure the Gateway.

Contact your network administrator for the IP address, subnet mask, and gateway to use. All IP addresses take the dot-notation form "nnn.nnn.nnn.nnn" where "nnn" in each case is a byte value in the range 0 through 255. You can enter a new IP address using the front panel arrow keys. Do not enter leading zeros.

5. Configure the "DNS Setup" (optional)

DNS (Domain Name Service) is an Internet service that translates domain names into IP addresses. Ask your network administrator whether DNS is in use, and if it is, for the host name, domain name, and DNS server address to use.

- a. Set the "hostname." Press **Host Name** and enter the hostname. A hostname is the host portion of the domain name, which is translated into an IP address. The hostname is entered as a string using the front panel arrow keys to select and change characters. The hostname may include letters, numbers, and dashes ("-").
- b. Set the "DNS Server" addresses. From the LAN configuration screen, press **More** to go to the second of three sets of softkeys.

Enter the Primary DNS and Second DNS. See your network administrator for details.

More about IP Addresses and Dot Notation

Dot-notation addresses ("nnn.nnn.nnn.nnn" where "nnn" is a byte value from 0 to 255) must be expressed with care, as most PC web software interprets byte values with leading zeros as octal (base 8) numbers. For example, "192.168.020.011" is actually equivalent to decimal "192.168.16.9" because ".020" is interpreted as "16" expressed in octal, and ".011" as "9". To avoid confusion, use only decimal values from 0 to 255, with no leading zeros.

Firmware Update

Use the following procedure to update instrument firmware:

CAUTION Do not turn off the instrument during the update.

1. Press [**Help**] > **About** to determine what instrument firmware version is currently installed.
2. Go to www.keysight.com/find/truevolt and use the links there to find the latest firmware version. If this matches the version installed on your instrument, there is no need to continue with this procedure. Otherwise, download the firmware update utility and a ZIP file of the firmware. Detailed firmware instructions are in the *Firmware Update Utility Instructions* located on the download page.
3. Unzip the ZIP file and use the firmware update utility to prepare a USB drive with the updated firmware:
4. Attach the USB drive to the instrument front panel and press [**Utility**] > **Test / Admin** > **Firmware Update** to update the firmware. If the security option is installed, unlock the instrument with the security code before installing firmware.

Important: In order to update the instrument firmware *from remote*, the model number in the *IDN? response must match the actual instrument model number. If you have changed the instrument's *IDN? response to another instrument, when attempting to update the firmware from remote, you will see this error: *The instrument is not supported by this firmware file.* To update the firmware, either update using the front panel procedure or, from remote, use SYSTem:IDENtify to set the *IDN? to match the actual model number, update the firmware, and then use SYSTem:IDENtify again to set the *IDN? response to the other model number.

Contacting Keysight Technologies



You can contact Keysight Technologies for warranty, service, or technical support.

In the United States: (800) 829-4444

In Europe: 31 20 547 2111

In Japan: 0120-421-345

Use www.keysight.com/find/assist to contact Keysight worldwide, or contact your Keysight Technologies representative.

Quick Start

This section describes basic procedures to help you get started quickly with the instrument.

- [Prepare Instrument for Use](#)
- [Adjust the Carrying Handle](#)
- [Use Built-in Help System](#)
- [Rack Mount the Instrument](#)

Prepare Instrument for Use

Verify that you received the following items. If anything is missing, please contact your nearest Keysight sales office or Keysight authorized reseller.

- Power cord (for country of destination)
- Certificate of Calibration (optional)
- *Keysight Automation-Ready CD* (Keysight IO Libraries Suite) (optional on 34460A)
- Supplemental documentation packet
- USB 2.0 cable (optional on 34460A)

The latest product documentation is available at www.keysight.com/find/truevolt-doc. For documentation for mobile devices, see www.keysight.com/find/truevolt-mobilehelp.

To download the Digital Multimeter Connectivity Utility, go to www.keysight.com/find/DMMutilitysoftware.

Setting the AC Mains Line Voltage Selector and Fuse Installation

WARNING

Before plugging the instrument into AC mains power, verify that the line voltage setting visible on the back of the AC mains input module is correct for the AC mains power source being connected. The line voltage selections are shown in a box on the rear panel immediately to the left of the AC mains input module. Other nominal line voltages are shown in parentheses.

Verify that the correct fuse is installed. To replace a blown fuse or verify the correct fuse, pull it gently from the fuse drawer and insert the correct working fuse. Use only a 5x20 mm, time-lag, 0.25 A, 250 V certified fuse. The Keysight part number is 2110-0817.

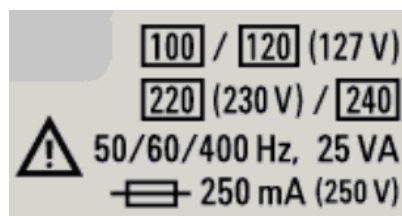

AC MAINS Nominal Line Voltage Range	AC Mains Line Voltage Selector
100 - 115	100
120 - 127	120
202 - 230	220
240	240

Quick Start

Use the following procedure to configure the line voltage selector:

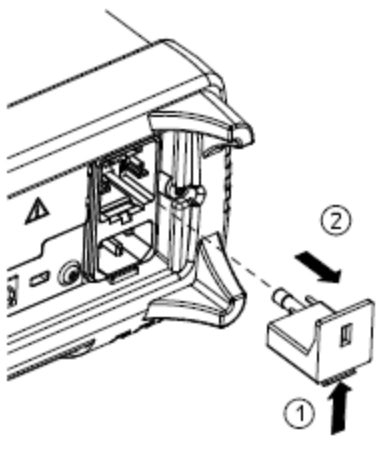
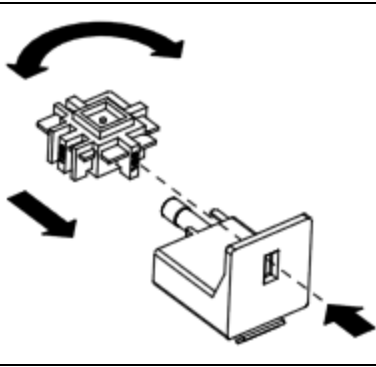
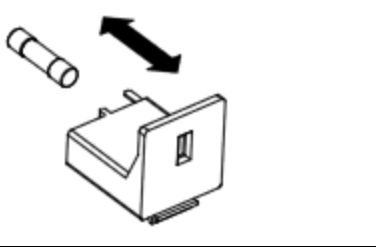
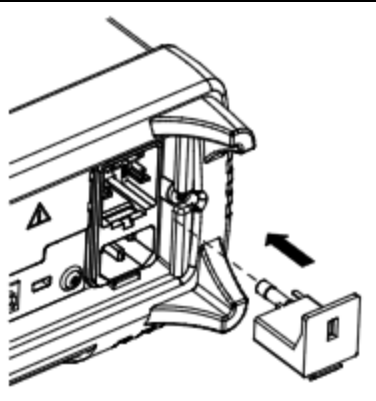
Step 1	Lift tab (1) and pull the fuse drawer (2) from the rear panel.	
Step 2	Remove the line-voltage selector and rotate it so the correct voltage will appear in the fuse holder window.	
Step 3	Verify that the correct fuse is installed. To replace a blown fuse or verify the correct fuse, pull it gently from the fuse drawer and insert the correct working fuse. Use only a 5x20 mm, time-lag, 0.25 A, 250 V certified fuse. The Keysight part number is 2110-0817.	
Step 4	Replace the fuse holder assembly by sliding it into the rear panel.	

WARNING Product Grounding

The instrument is a Class 1 product and is provided with a grounding-type power cord set. The instrument chassis and cover are connected to the instrument electrical ground to minimize shock hazard. The ground pin of the cord set plug must be firmly connected to the electrical ground (safety ground) terminal at the power outlet. Any interruption of the protective earth (grounding) conductor or disconnection of the protective earth terminal will cause a potential shock hazard that could result in personal injury or death.

Connect Power and I/O Cables

Connect the power cord and LAN, GPIB, or USB cable as desired. After you turn on the instrument (as described below), the instrument will run a power-on self test and then display a message about how to obtain help, along with the current IP address. It also displays the GPIB address (if applicable).

The instrument's default measurement function is DC Voltage (DCV), with autoranging enabled.

Power Switch 

Press the power switch in the lower left corner of the front panel. If the instrument does not turn on, verify that the power cord is firmly connected and that the fuse is good and the line voltage selector is set correctly, as described above. Also make sure that the instrument is connected to an energized power source. If the LED below the power switch is off, there is no AC mains power connected. If the LED is amber, the instrument is in standby mode with AC mains power connected, and if it is green, the instrument is on.

NOTE In certain circumstances, the amber LED can come on even if the wrong line voltage is selected. In this case, the instrument may not power on.

If the power-on self test fails, the display shows **Error** in the upper right corner. It also displays a message describing the error. See [SCPI Error Messages](#) for information on error codes. See [Service and Repair - Introduction](#) for instructions on returning the instrument for service.

To turn off the instrument, press and hold the power switch for about 500 ms. This prevents you from accidentally turning off the instrument by brushing against the power switch.

NOTE If you turn off the instrument by disconnecting power (this is not recommended), the instrument turns on as soon as you re-apply power. You will not need to press the power switch.

Quick Start

Adjust the Carrying Handle

The handle has three positions, shown below.

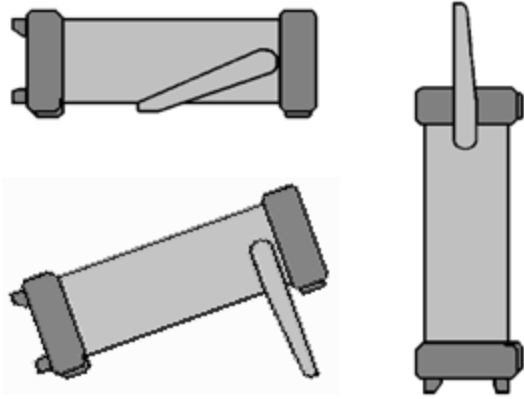

To adjust the handle position, grasp the sides of the handle, pull outward, and rotate the handle.

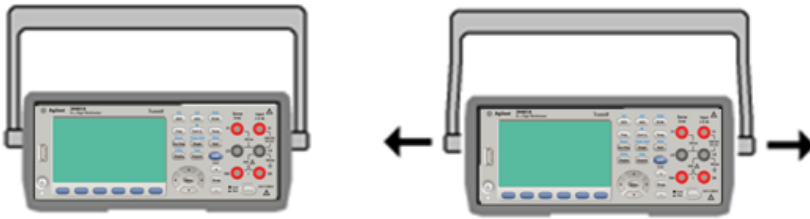

Use Built-in Help System

The built-in help system provides context-sensitive help on any front panel key or menu softkey. A list of help topics is also available to help you learn about the instrument.

View the help information for a front panel key

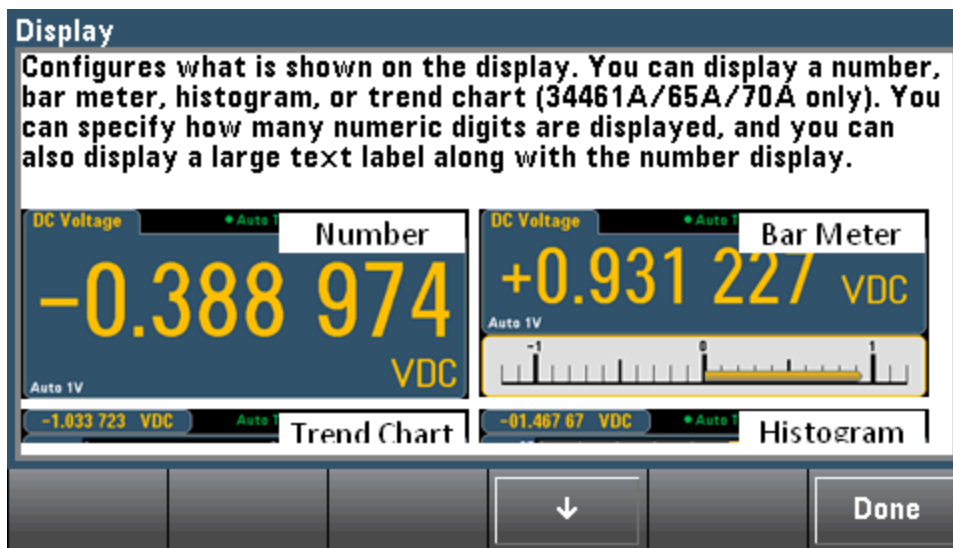

Press and hold any softkey or button, such as **[Display]**.

If the message contains more information than will fit on the display, press the down arrow softkey to scroll down.



Press **Done** to exit Help.

View the list of help topics and use interactive demos

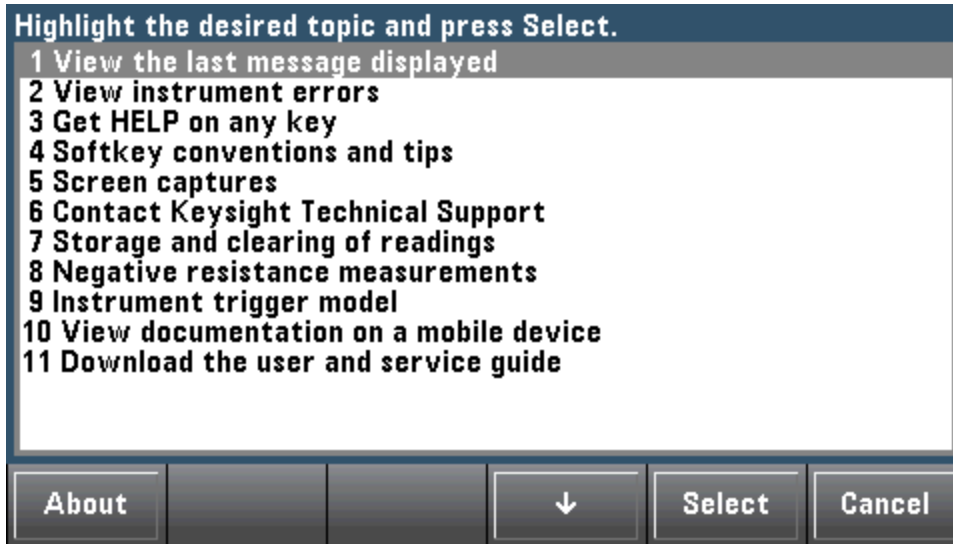

Press   to view the list of help topics. Press the arrow softkeys or use the front panel arrow keys to highlight the desired topic. Then press **Select**. You can also press **Demos** to run interactive demos on how to use the instrument.

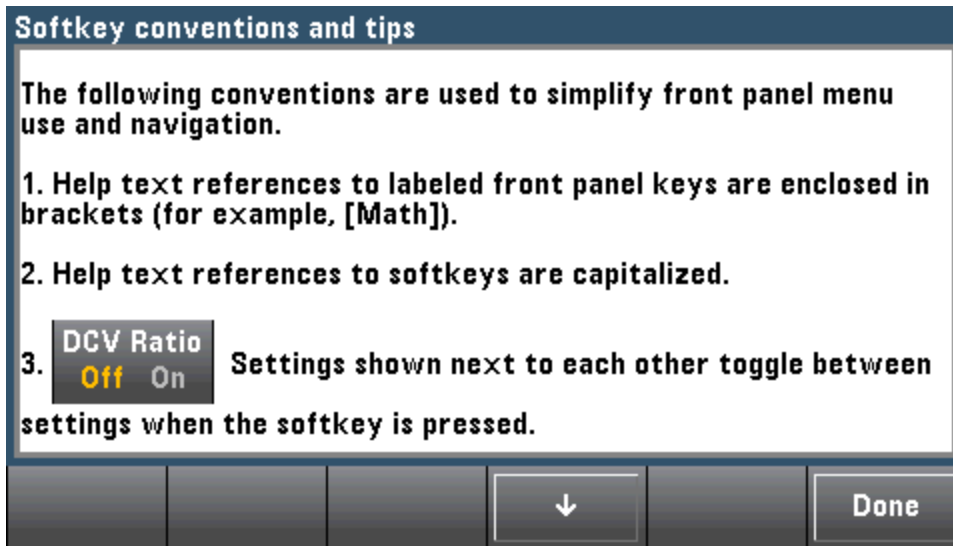

In this case, the following help topic appears:



View the list of recent instrument errors.

Press   and choose **View instrument errors** from the list of help topics. This displays the instrument's error queue, which includes up to 20 errors.

View the help information for displayed messages.

Whenever a limit is exceeded or any other invalid configuration is found, the instrument displays a message. The built-in help system provides additional information on the most recent message. Press **[Shift] > [Help]**, select **View the last message displayed**, and press **Select**.

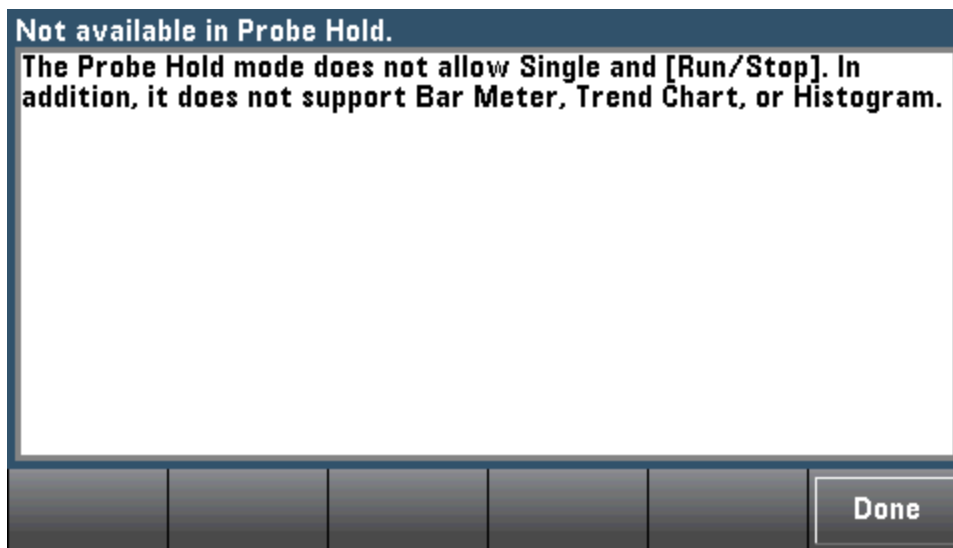

Press **Done** to exit Help.

NOTE

Local Language Help

All messages, context-sensitive help, and help topics are available in English, Chinese, French, German, Japanese, Korean, and Russian. To select the local language, press **[Utility] > System Setup > User Settings > Help Lang**. Then select the desired language.

The menu softkey labels and status line messages are not translated.

Rack Mount the Instrument

You can mount the instrument in a standard 19-inch rack cabinet using one of two optional kits, each of which includes instructions and mounting hardware. You may also mount Another Keysight System II instrument of the same height and width beside the instrument.

CAUTION To prevent overheating, do not block airflow to or from the instrument. Allow enough clearance at the rear, sides, and bottom of the instrument to permit adequate internal air flow.

NOTE Remove the carrying handle and the front and rear bumpers before rack-mounting the instrument.

Removing the Handle and Bumpers

To remove the handle, rotate it to vertical and pull the ends outward.

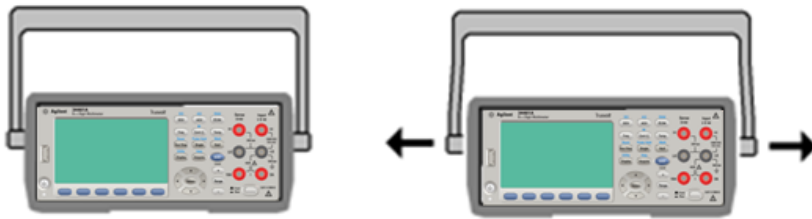

To remove the rubber bumper, stretch a corner and then slide it off.

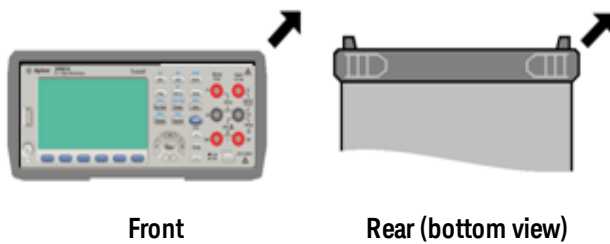

Front

Rear (bottom view)

Rack Mounting a Single Instrument

To rack mount a single instrument, order adapter kit 5063-9240.

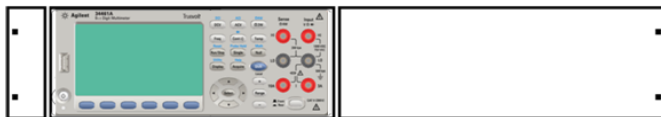

Rack Mounting Instruments Side-by-Side

To rack mount two instruments side-by-side, order lock-link kit 5061-8769 and flange kit 5063-9212. Be sure to use the support rails in the rack cabinet.



Sliding Support Shelf

To install one or two instruments in a sliding support shelf, order shelf 5063-9255 and slide kit 1494-0015. For a single instrument, also order filler panel 5002-3999.

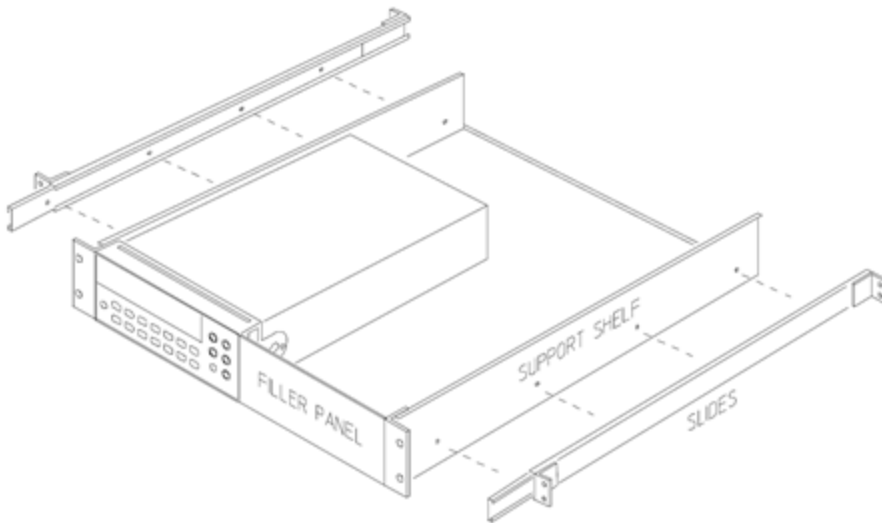

Features and Functions

This section contains details on instrument features, including front panel and remote interface operation. Read the [Front Panel Menu Reference](#) first. See [Introduction to SCPI Language](#) for details on SCPI commands and queries.

This section covers:

[Front Panel Menu Reference](#)

[Measurements](#)

[Triggering and Readings](#)

[Probe Hold](#)

[Math Menu](#)

[Display Menu](#)

[Utility Menu](#)

[Web Interface](#)

Throughout this document, "default" states and values are identified. These are the [power-on default states](#) when the instrument is shipped from the factory.

Continuous, Data Log, and Digitize Modes

The 34465A/70A can operate in the continuous, data log, or digitize mode as described below.

NOTE The 34460A/61A DMMs always operate in the continuous mode -data log and digitize modes are not available on these models.

Continuous Mode

Continuous mode is the default mode for all Truevolt DMMs. With the factory default settings, the DMM continuously makes DCV measurements with autorange and autozero on, NPLC set to 10 PLCs, etc. (see factory defaults for details).

Data Log Mode

The Data Log mode is standard on the 34465A and 34470A only, as is available only from the DMM's front panel. Data Log mode provides a front-panel user interface that allows you to set up data logging into the instrument's non-volatile memory, or to internal/external file(s), without programming, and without a connection to a computer. Once you have finished collecting data, you can view it from the front panel, or you can transfer the data to your computer. Data Log mode allows you to log a specified number of readings, or readings acquired for a specified period of time, to instrument memory or to internal or external data files.

To select Data Log mode, press **[Acquire] Acquire > Data Log**. You can then select the Sample Interval (time between measurements - for example, 500 mS), Duration as either an amount of Time or a number of Readings, whether to Start after a Delay or at a specific Time of Day, and whether to Log to Memory or Log to File(s). After configuring the data logging parameters, press **[Run/Stop]**. Data logging will begin following the specified Delay or at the specified Time of Day.

Digitize Mode

The digitize mode applies only to the 34465A/70A with the DIG option, and as is available only from the DMM's front panel. The digitized mode provides a front-panel user interface that allows you to quickly set up digitized measurements.

Digitizing is the process of converting a continuous analog signal, such as a sine wave, into a series of discrete samples (readings). The figure below shows the result of digitizing a sine wave. This chapter discusses the various ways to digitize signals. The importance of the sampling rate, and how to use level triggering.

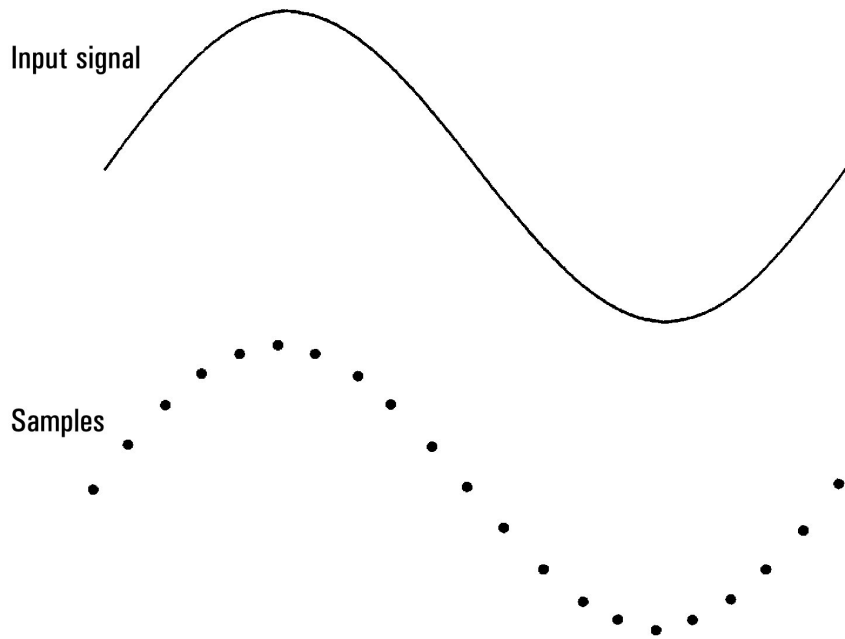

Data Log and Digitize Mode Default Settings

On entering data log or digitize mode, the DMM configures these settings:

- Trigger count set to 1 (trigger count is normally infinite when in Local and is not settable from the front panel).
- Secondary measurements are turned off.
- Math smoothing is turned off.
- Statistics are cleared.
- Histogram is cleared.
- Trend chart is changed from the continuous, bucketized mode, to simple data graph.

Additional Data Log Default Settings

On entering data log mode, the DMM configures these settings::

- Trigger source is set to auto.
- Trigger delay is set to auto.
- Pretrigger count is set to zero.
- Samples per trigger is set according to the data log duration (time or samples).
- Sample timer is put in timer (not immediate) mode and sample time is set according to the data log sample interval.











Additional Digitize Default Settings







On entering digitize mode, the DMM configures these settings:



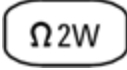

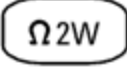
- If trigger source is set to manual it is changed to auto. (external and level remain as is.)
- Limits mode is turned off.
- Scaling is turned off.
- Statistic and histogram are put in post-processing mode (computed after digitize is complete).
- On the selected function (DCV or DCI) and for the new function if changed :
 - Autorange is turned off.
 - Autozero is turned off.
 - NPLC and aperture are set to their minimum values.
- If trigger source is external or level, the pretrigger count is set to the digitize pretrigger count setting (default of 0).
- Samples per trigger is set according to the digitize duration (time or samples).
- Sample timer is put in timer (not immediate) mode and Sample timer is set according to the digitize sample rate or sample interval.
- Trend Chart mode is changed to bucketized when data logging to a file.
- On return to Continuous mode, settings are left as done in data log or digitize mode except:
 - Sample source is set to immediate.
 - Pretrigger count is set to 0.
 - Samples per trigger is set to 1.
 - Trigger count is set to infinite.



















Front Panel Menu Reference

The following table summarizes the front panel keys and the menu structure.

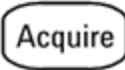
Key	Purpose
 	<p>Configure DC voltage measurements, including DCV ratio measurements:</p> <p>Range: Autorange (default), 100 mV, 1 V, 10 V, 100 V, or 750 V</p> <p>Aperture NPLC: 0.02, 0.2, 1, 10, 100. Default: 10 (34460A/61A) 0.02, 0.06, 0.2, 1, 10, 100. Default: 10 (34465A/70A without DIG option) 0.001, 0.002, 0.006, 0.02, 0.06, .2, 1, 10, 100. Default: 10 (34465A/70A with DIG option)</p> <p>See Range, Resolution and NPLC for more information.</p> <p>Aperture Time (applies only to the 34465A and 34470A): (<i>Without</i> the DIG option) 200 μs to 1 s (2 μs resolution), default: 100 ms. (<i>With</i> the DIG option) 20 μs to 1 s (2 μs resolution), default: 100 ms.</p> <p>Auto Zero: Off or On (default)</p> <p>Input Z: 10 MΩ (default) or High Z (> 10 GΩ)</p> <p>DCV Ratio: Off (default) or On</p>
  	<p>Configure DC current measurements:</p> <p>Terminals: 3 A or 10 A</p> <p>Range: Auto, 100 μA, 1 mA, 10 mA, 100 mA, 1 A, 3 A, or 10 A (when terminals set to 10 A). The 34465A and 34470A have additional 1 μA and 10 μA DC current ranges.</p> <p>Aperture NPLC: 0.02, 0.2, 1, 10, 100. Default: 10 (34460A/61A) 0.02, 0.06, 0.2, 1, 10, 100. Default: 10 (34465A/70A without DIG option) 0.001, 0.002, 0.006, 0.02, 0.06, .2, 1, 10, 100. Default: 10 (34465A/70A with DIG option)</p> <p>See Range, Resolution and NPLC for more information.</p> <p>Aperture Time (applies only to the 34465A and 34470A): (<i>Without</i> the DIG option) 200 μs to 1 s (2 μs resolution), default: 100 ms. (<i>With</i> the DIG option) 20 μs to 1 s (2 μs resolution), default: 100 ms.</p> <p>Auto Zero: Off or On (default)</p>
 	<p>Configure AC voltage measurements:</p> <p>Range: Autorange (default), 100 mV, 1 V, 10 V, 100 V, or 750 V</p> <p>Filter: >3 Hz, >20 Hz, >200 Hz</p>
  	<p>Configure AC current measurements:</p> <p>Terminals: 3 A or 10 A</p> <p>Range: Auto, 100 μA, 1 mA, 10 mA, 100 mA, 1 A, 3 A, or 10 A (when terminals set to 10 A)</p> <p>Filter: >3 Hz, >20 Hz, >200 Hz</p>

Key	Purpose
 	<p>Configure 2-wire resistance measurements:</p> <p>Range: 100 Ω, 1 kΩ, 10 kΩ, 100 kΩ, 1 MΩ, 10 MΩ, 100 MΩ, 1 GΩ (34465A and 34470A only) or Auto (default). Note: The approximate current sourced for each range (for example, ~1mA) is shown on each range softkey.</p> <p>Aperture NPLC: 0.02, 0.2, 1, 10, 100. Default: 10 (34460A/61A) 0.02, 0.06, 0.2, 1, 10, 100. Default: 10 (34465A/70A without DIG option) 0.001, 0.002, 0.006, 0.02, 0.06, .2, 1, 10, 100. Default: 10 (34465A/70A with DIG option)</p> <p>See Range, Resolution and NPLC for more information.</p> <p>Aperture Time (applies only to the 34465A and 34470A): (<i>Without</i> the DIG option) 200 μs to 1 s (2 μs resolution), default: 100 ms. (<i>With</i> the DIG option) 20 μs to 1 s (2 μs resolution), default: 100 ms.</p> <p>Auto Zero: Off or On (default)</p> <p>OffstComp: Off (default) or ON. Applies only to the 34465A and 34470A.</p> <p>Low Power: Disables (Off) or enables (On) low power measurements. Applies only to the 34465A and 34470A.</p>
  	<p>Configure 4-wire resistance measurements.</p> <p>Range: 100 Ω, 1 kΩ, 10 kΩ, 100 kΩ, 1 MΩ, 10 MΩ, 100 MΩ, 1 GΩ (34465A and 34470A only) or Auto (default). Note: The approximate current sourced for each range (for example, ~1mA) is shown on each range softkey.</p> <p>Aperture NPLC: 0.02, 0.2, 1, 10, 100. Default: 10 (34460A/61A) 0.02, 0.06, 0.2, 1, 10, 100. Default: 10 (34465A/70A without DIG option) 0.001, 0.002, 0.006, 0.02, 0.06, .2, 1, 10, 100. Default: 10 (34465A/70A with DIG option)</p> <p>See Range, Resolution and NPLC for more information.</p> <p>Aperture Time (applies only to the 34465A and 34470A): (<i>Without</i> the DIG option) 200 μs to 1 s (2 μs resolution), default: 100 ms. (<i>With</i> the DIG option) 20 μs to 1 s (2 μs resolution), default: 100 ms.</p> <p>OffstComp: Off (default) or ON. Applies only to the 34465A and 34470A.</p> <p>Low Power: Disables (Off) or enables (On) low power measurements. Applies only to the 34465A and 34470A.</p>
	<p>Configure frequency and period measurements. Parameters include range, AC filter, and gate time.</p> <p>Range: 100 mV, 1 V, 10 V, 100 V, 750 V, Auto (default)</p> <p>Filter: >3 Hz, >20 Hz, >200 Hz</p> <p>Gate Time: 10 ms, 100 ms (default), or 1 s</p> <p>Timeout: 1 s (default) or Auto</p>
  	<p>Configure capacitance measurements:</p> <p>Range: 1 nF, 10 nF, 100 nF, 1 μF, 10 μF, 100 μF, or Auto (default)</p>

Key	Purpose
	Configure continuity measurements: Beeper: Off or On (default)
	Configure diode measurements: Beeper: Off or On (default)
	Configure 2-wire and 4-wire temperature measurements. Probe Settings: RTD 2w, RTD 4w (default), Thermis2w, Thermis4w, TCouple (34465A/70A only) Additional settings for probe type RTD 2w or RTD 4w: <ul style="list-style-type: none"> • R0: R_0 is the nominal resistance of an RTD at 0 °C. Default 100 Ω • Low Power: Disables (Off) or enables (On) low power measurements. Applies only to the 34465A and 34470A. Additional settings for probe type Thermis2w and Thermis4w: <ul style="list-style-type: none"> • Low Power: Disables (Off) or enables (On) low power measurements. Applies only to the 34465A and 34470A. Additional settings for probe type TCouple: <ul style="list-style-type: none"> • Type: J (default), K, E, T, N, or R • Reference: Internal or Fixed • Offset Adjust: (Available for an internal reference only). -20 °C to +20 °C. Default: 0 °C. • Fixed Offset: (Available for a fixed reference only) -20 °C to +80 °C. Default: 0 °C. Aperture NPLC: 0.02, 0.2, 1, 10, 100. Default: 10 (34460A/61A) 0.02, 0.06, 0.2, 1, 10, 100. Default: 10 (34465A/70A without DIG option) 0.001, 0.002, 0.006, 0.02, 0.06, .2, 1, 10, 100. Default: 10 (34465A/70A with DIG option) See Range, Resolution and NPLC for more information. Aperture Time (applies only to the 34465A and 34470A): (<i>Without</i> the DIG option) 200 μ s to 1 s (2 μ s resolution), default: 100 ms. (<i>With</i> the DIG option) 20 μ s to 1 s (2 μ s resolution), default: 100 ms. Auto Zero: Off or On (default) (2-wire measurements only; not available for 4-wire measurements) OffstComp: Off (default) or ON. (RTD 2-wire and RTD 4-wire measurements only) Open Check: TCouple measurements only.* Units: °C, °F, or K
	Start and stop measurements.

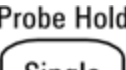
Key	Purpose
 	Reset the instrument for front panel use; equivalent to SYST:PRESet .
	Take a single measurement.
 	Take one or more hands-free measurements.
	Take a null measurement.
 	Configure the null function, smoothing filter (applies only to the 34465A and 34470A), scaling, statistics, and limits.
	Configure the text and graphics that appear on the display and secondary measurements.
 	Store and recall instrument states and preferences. Configure I/O interfaces: LAN (optional on 34460A), USB, GPIB (optional). Perform system administration tasks, including calibration. Configure user preferences. Perform file management activities, including the creation of "screen shot" files (display images).
 	Learn about the instrument, learn how to download or view documentation, view the last error message, or clear error messages.
 	Perform autocalibration.
	Select manual or auto ranging. Press  to manually uprange,  to manually downrange.
	Return to local control of the instrument (when in Remote mode), or indicate that the next front panel key will be "shifted," for example [Probe Hold] instead of [Single] . 

Features and Functions

The keys that access a wide range of functions are listed below.

[Acquire] key



Softkey	Description
Acquire	Select Continuous mode (default measurement mode), Digitize mode, or Data Log mode.*
Trigger Settings	Configure triggering.
VMC Out	Set slope of VM Comp output.
Save Readings	Save readings to a file.

* *Digitize and Data Log modes are available only on the 34465A/70A. The Digitize mode requires the DIG option.*

[Math] key



The availability of the Math softkeys varies by measurement function.

Softkey	Description
Null	Enable/disable use of null values and specify null value to use.
Smoothing Filter	(34465A/70A only) Smoothing uses a moving average (boxcar) filter to reduce random noise in measurements. Smoothing is intended to average out small variations in the measurements. Larger variations will cause the filter to reset.
dB / dBm	(34460A/61A only) Configure dB, dBm
Scaling	(34465A/70A only) Configure scaling: dB, dBm, %, Mx-B
Statistics	Enable, disable, and clear statistics.
Limits	Enable or disable high and low limits.

[Display] key



Softkey	Description
Display	Choose what is displayed: number, bar meter, histogram, or trend chart (34461A/65A/70A only).
Label	Enable or disable the display of a message.
Label Text	Edit the text displayed when the Label softkey is On.
2nd Meas	Select a secondary measurement.
Digit Mask	Set the number of digits displayed for measurements.

[Utility] key



Softkey	Description
Store/Recall	Store and recall state and preference files and set power-on defaults.
Manage Files	Perform basic file management tasks and screen captures.
I/O Config	Configure LAN (optional on 34460A), USB, and GPIB (optional) interfaces.
Test/Admin	Perform self-test, calibration, security, license, and firmware update tasks.
System Setup	Set user preferences, date and time, and power-on message.

Measurements

The Keysight Truevolt DMMs support many common measurements:

[DC Voltage](#)

[AC Voltage](#)

[DC Current](#)

[AC Current](#)

[Resistance](#)

[Temperature](#)

[Capacitance](#)

[Continuity](#)

[Diode](#)

[Frequency and Period](#)

[Data Logging](#)

[Digitizing](#)

[Level Triggering](#)

DC Voltage

This section describes how to configure DC voltage measurements from the front panel, including DCV ratio measurements.

Step 1: Configure the test leads as shown.

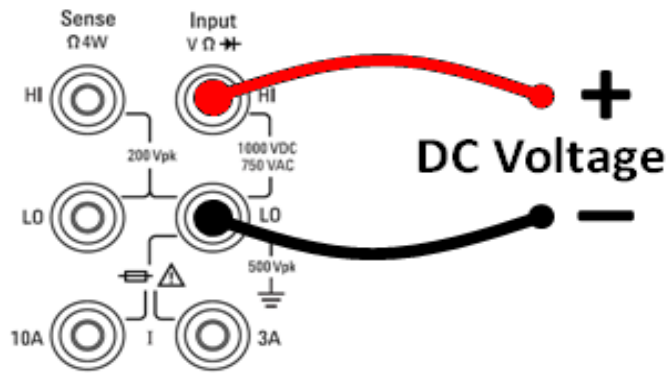

Step 2: Press [DCV] on the front panel.

Step 3:

- For the 34460A/61A, press **Aperture** and choose the number of power-line cycles (PLCs) to use for the measurement. Only 1, 10, and 100 PLC provide normal mode (line frequency noise) rejection. Selecting 100 PLC provides the best noise rejection and resolution, but the slowest measurements:

Range Auto	Aperture 10 PLC	Auto Zero Off On	Input Z 10M Auto	DCV Ratio Off On
----------------------	---------------------------	----------------------------	----------------------------	----------------------------

Select # of Power Line Cycles				
100 PLC	10 PLC	1 PLC	0.2 PLC	0.02 PLC

- For the 34465A/70A, the **Aperture NPLC** softkey is selected by default. Use the up/down arrow keys to specify integration time in power-line cycles (PLCs) to use for the measurement. 1, 10, and 100 PLC provide normal mode (line frequency noise) rejection. Selecting 100 PLC provides the best noise rejection and resolution, but the slowest measurements:



To set integration time precisely, instead of using PLCs, press **Aperture Time** and use the left/right up/down arrow keys to specify integration time in seconds. For **Aperture Time**, you can specify from 200 μ s (20 μ s with the DIG option) to 1 s integration time (2 μ s resolution):



Step 4: Press **Range** to select a range for the measurement. You can also use the [+], [-], and [**Range**] keys on the front panel to select the range. (**Auto** (autorange) automatically selects the range for the measurement based on the input. Autoranging is convenient, but it results in slower measurements than using a manual range. Autoranging goes up a range at 120% of the present range, and down a range below 10% of the present range.)



Step 5: Auto Zero: Autozero provides the most accurate measurements, but requires additional time to perform the zero measurement. With autozero enabled (On), the DMM internally measures the offset following each measurement. It then subtracts that measurement from the preceding reading. This prevents offset voltages present on the DMM's input circuitry from affecting measurement accuracy. With autozero disabled (Off), the DMM measures the offset once and subtracts the offset from all subsequent measurements. The DMM takes a new offset measurement each time you change the function, range, or integration time. (There is no autozero setting for 4-wire measurements.)

Step 6: Specify the input impedance to the test leads (**Input Z**). This specifies the measurement terminal input impedance, which is either Auto or 10 M Ω . The Auto mode selects high impedance (HighZ) for the 100 mV, 1 V and 10 V ranges, and 10 M Ω for the 100 V and 1000 V ranges. In most situations, 10 M Ω is high enough to not load most circuits, but low enough to make readings stable for high impedance circuits. It also leads to readings with less noise than the **HighZ** option, which is included for situations where the 10 M Ω load is significant.

DCV Ratio

The **DCV Ratio** key enables or disables DCV Ratio measurement. Note that the **Auto Zero** softkey disappears when you enable DCV Ratio measurements. This is because autozero cannot be disabled during DCV Ratio.

The ratio is the voltage on the Input terminals divided by the reference voltage. The reference voltage is the difference of two separate measurements. These measurements are the DC voltages from the HI Sense terminal to the LO Input terminal and from the LO Sense terminal to the LO Input terminal. These two measurements must be within the range of ± 12 VDC. The reference voltage is always autoranged, and the range used for both will be based on the larger result of these two measurements.

Configure DCV Ratio measurements as shown:

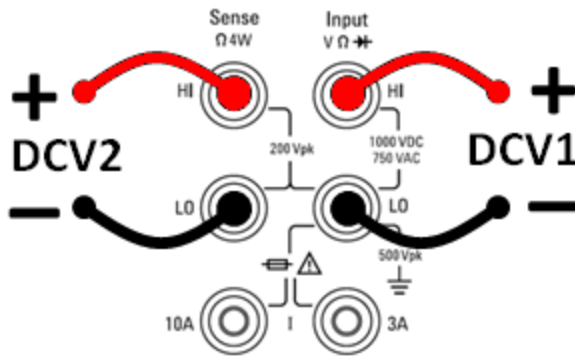

AC Voltage

This section describes how to configure AC voltage measurements from the front panel.

NOTE Default delays are selected to give correct first readings for most measurements. For the most accurate measurements, the input blocking RC time constant must settle to 1/50 of the AC signal level.

Signals greater than 300 V (rms) or 1 A (rms) will cause self-heating in signal-conditioning components. These errors are included in the instrument specifications. Internal temperature changes due to self-heating may cause additional error on other functions or ranges. The additional error will generally dissipate within a few minutes.

For example, consider a 100 mVAC signal with a 10 VDC bias. The 10 VDC bias should be settled to 1/50 of 100 mVAC, or 2 mVDC. The corresponding settling time can be calculated using the blocking RC time constant of 0.22 s as follows:

$$\text{settling time} = \ln(\text{bias}/\text{settled value}) * 0.22 \text{ s}$$

$$\text{settling time} = \ln(10 \text{ VDC} / 2 \text{ mVDC}) * 0.22 \text{ s}$$

$$\text{settling time} = \ln(5000) * 0.22 \text{ s} = 1.9 \text{ s}$$

This additional settling delay should be applied after connecting the signal to the DMM's ACV input or after selecting the ACV function with the signal already connected. If the DC bias remains constant, subsequent measurements can be made to full accuracy without additional settling delays.

Step 1: Configure the test leads as shown.

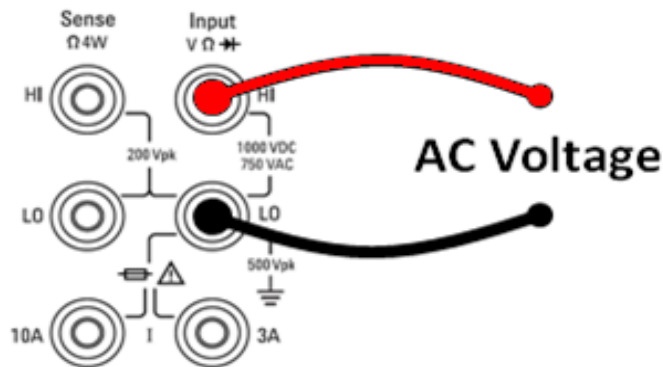

Step 2: Press [ACV] on the front panel.

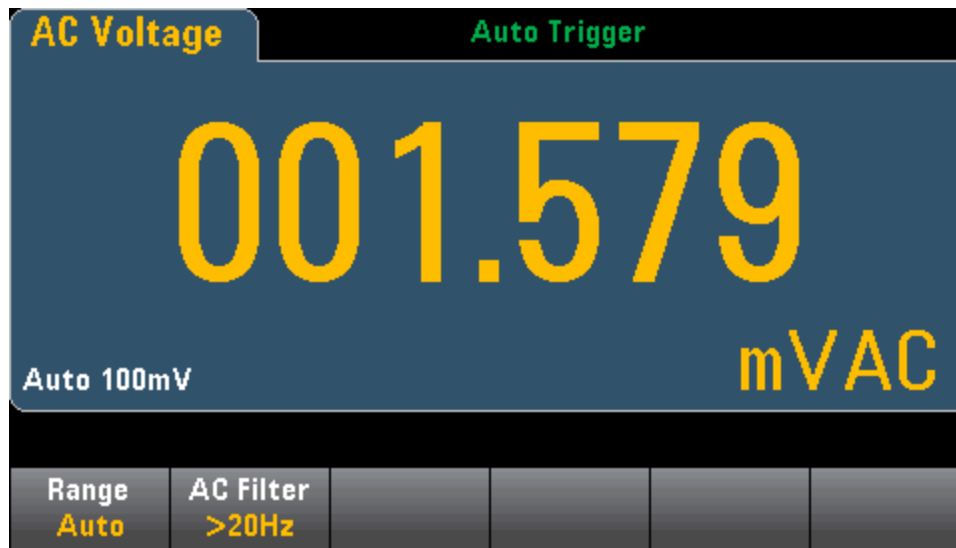

Step 3: Press **Range** to select a range for the measurement. (**Auto** (autorange) automatically selects the range for the measurement based on the input. Autoranging is convenient, but it results in slower measurements than using a manual range. Autoranging goes up a range at 120% of the present range, and down a range below 10% of the present range.



Step 4: Press **AC Filter** and choose the filter for the measurement. The instrument uses three different AC filters that enable you either to optimize low frequency accuracy or to achieve faster AC settling times following a change in input signal amplitude.

The three filters are 3 Hz, 20 Hz, and 200 Hz, and you should generally select the highest frequency filter whose frequency is less than that of the signal you are measuring, because higher frequency filters result in faster measurements. For example, when measuring a signal between 20 and 200 Hz, use the 20 Hz filter.

If measurement speed is not an issue, choosing a lower frequency filter may result in quieter measurements, depending on the signal that you are measuring.



NOTE For accurate displayed statistics of AC measurements in Front Panel mode, the default manual trigger delay (**[Acquire] > Delay Man**) must be used.

DC Current

This section describes how to configure DC current measurements from the front panel.

Step 1: Configure the test leads as shown.

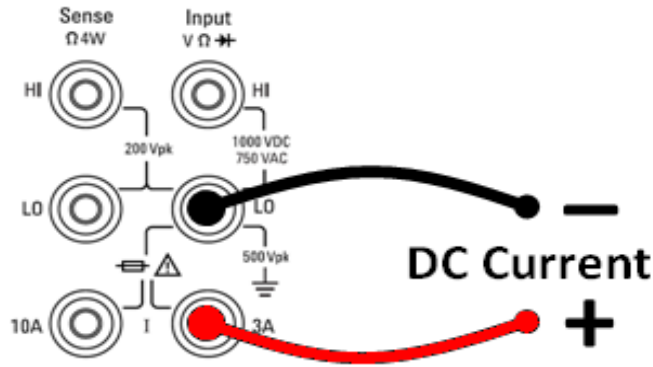

On the 34461A/65A/70A, you can also configure the measurement using the 10 A terminal, which is recommended when measuring current above 1 A:

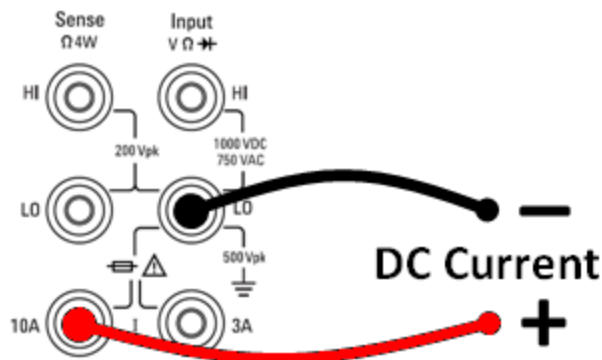

Step 2: Press [DCI] on the front panel.



Step 3: For the 34465A/70A, the Aperture NPLC softkey is selected by default. Use the up/down arrow keys to specify integration time in power-line cycles (PLCs) to use for the measurement . 1, 10, and 100 PLC provide normal mode (line frequency noise) rejection. Selecting 100 PLC provides the best noise rejection and resolution, but the slowest measurements:

Step 4 (34461A/65A/70A only): The 3A terminals are selected by default. The Terminals softkey toggles between the 3 A terminals and the 10 A input terminals. When you change this to 10 A, the measurement range automatically becomes 10 A.

Step 5: Press **Range** to select a range for the measurement. You can also use the **[+]**, **[-]**, and **[Range]** keys on the front panel to select the range. (**Auto** (autorange) automatically selects the range for the measurement based on the input. Autoranging is convenient, but it results in slower measurements than using a manual range. Autoranging goes up a range at 120% of the present range, and down a range below 10% of the present range. Press **More** to switch between the two pages of settings.

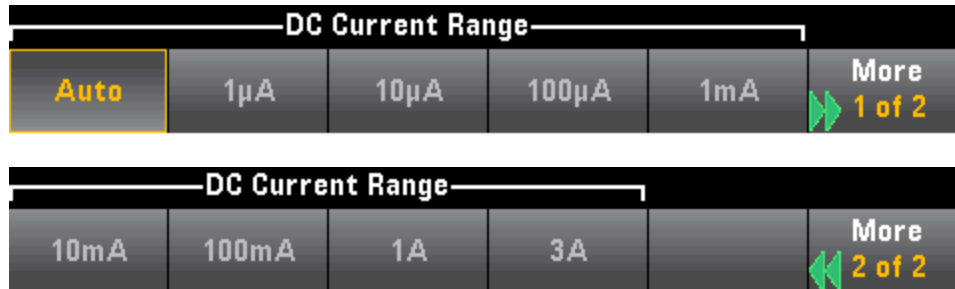

Step 6: Auto Zero: Autozero provides the most accurate measurements, but requires additional time to perform the zero measurement. With autozero enabled (On), the DMM internally measures the offset following each measurement. It then subtracts that measurement from the preceding reading. This prevents offset voltages present on the DMM's input circuitry from affecting measurement accuracy. With autozero disabled (Off), the DMM measures the offset once and subtracts the offset from all subsequent measurements. The DMM takes a new offset measurement each time you change the function, range, or integration time. (There is no autozero setting for 4-wire measurements.)

AC Current

This section describes how to configure AC current measurements from the front panel.

Step 1: Configure the test leads as shown.

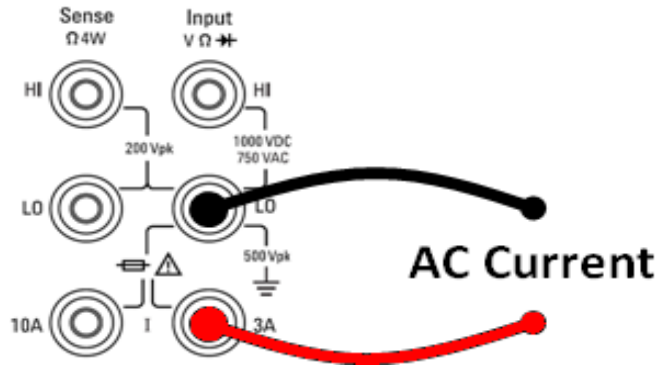

On the 34461A/65A/70A, you can also configure the measurement using the 10 A terminal, which is recommended when measuring current above 1 A:

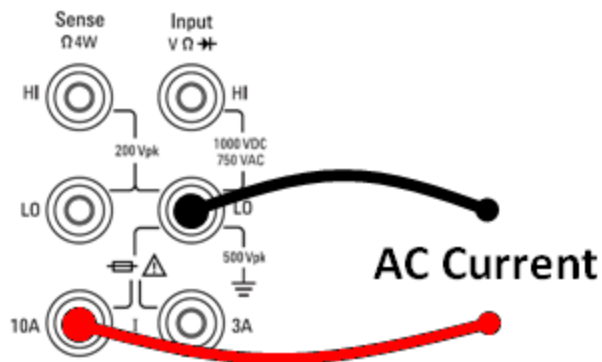

Step 2: Press [ACI] on the front panel.

Terminals	Range	AC Filter			
3A 10A	Auto	>20Hz			

Step 3 (34461A/65A/70A only): The 3A terminals are selected by default. The **Terminals** softkey toggles between the 3 A terminals and the 10 A input terminals. When you change this to 10 A, the measurement range automatically becomes 10 A.

CAUTION When making measurements using the 10A terminals, the presence of a signal on the 3A terminals can cause significant errors.

Step 4: Press **Range** to select a range for the measurement. You can also use the **[+]**, **[-]**, and **[Range]** keys on the front panel to select the range. (**Auto** (autorange) automatically selects the range for the measurement based on the input. Autoranging is convenient, but it results in slower measurements than using a manual range. Autoranging goes up a range at 120% of the present range, and down a range below 10% of the present range. Press **More** to switch between the two pages of settings.

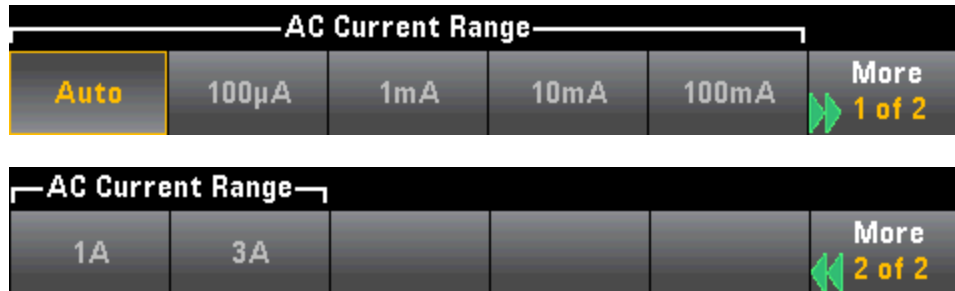

Step 5: Press **AC Filter** and choose the filter for the measurement. The instrument uses three different AC filters that enable you either to optimize low frequency accuracy or to achieve faster AC settling times following a change in input signal amplitude.

The three filters are 3 Hz, 20 Hz, and 200 Hz, and you should generally select the highest frequency filter whose frequency is less than that of the signal you are measuring, because higher frequency filters result in faster measurements. For example, when measuring a signal between 20 and 200 Hz, use the 20 Hz filter.

If measurement speed is not an issue, choosing a lower frequency filter may result in quieter measurements, depending on the signal that you are measuring.



NOTE For accurate displayed statistics of AC measurements in Front Panel mode, the default manual trigger delay (**[Acquire] > Delay Man**) must be used.

Resistance

This section describes how to configure 2-wire and 4-wire resistance measurements from the front panel.

Step 1: Configure the test leads as shown.

2-wire Resistance:

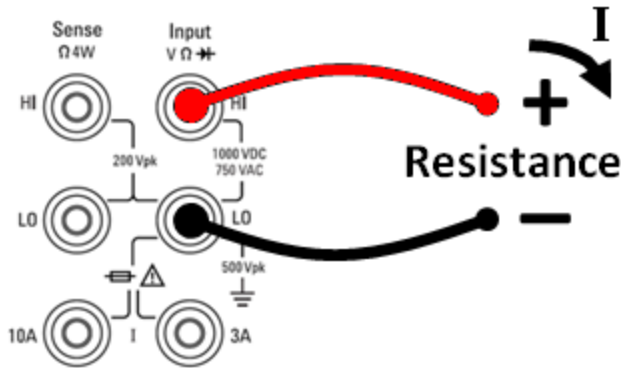

4-wire Resistance:

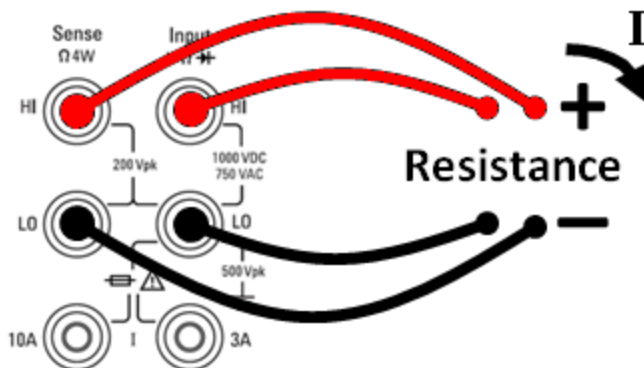

Step 2: Press [$\Omega 2W$] or [$\Omega 4W$] on the front panel. The following menu appears. (The $\Omega 4W$ menu does not include **Auto Zero**.)

10 PLC					
Range	Aperture	Auto Zero	OffstComp	Low Power	
Auto	NPLC Time	Off On	Off On	Off On	

Step 3: For the 34465A/70A, the **Aperture NPLC** softkey is selected by default. Use the up/down arrow keys to specify integration time in power-line cycles (PLCs) to use for the measurement . 1, 10, and 100 PLC provide normal mode (line frequency noise) rejection. Selecting 100 PLC provides the best noise rejection and resolution, but the slowest measurements:

Step 4: Press **Range** to select a range for the measurement. (**Auto** (autorange) automatically selects the range for the measurement based on the input. Autoranging is convenient, but it results in slower measurements than using a manual range. Autoranging goes up a range at 120% of the present range, and down a range below 10% of the present range. Press **More** to switch between the two pages of settings.



Notice the amount of test current sourced is shown for each range. After selecting a range, the main resistance menu is displayed.



Step 5: Auto Zero: Autozero provides the most accurate measurements, but requires additional time to perform the zero measurement. With autozero enabled (On), the DMM internally measures the offset following each measurement. It then subtracts that measurement from the preceding reading. This prevents offset voltages present on the DMM's input circuitry from affecting measurement accuracy. With autozero disabled (Off), the DMM measures the offset once and subtracts the offset from all subsequent measurements. The DMM takes a new offset measurement each time you change the function, range, or integration time. (There is no autozero setting for 4-wire measurements.)

Step 6: OffstComp (34465A/70A only): Enables or disables offset compensation. Offset compensation removes the effects of small dc voltages in the circuit being measured. The technique involves taking the difference between two resistance measurements, one with the current source set to the normal value, and one with the current source set to a lower value. Enabling Offset Compensation approximately doubles the reading time.

Step 7: Low Power (34465A/70A only): The low power mode sources less test current per measurement range than is normally sourced for standard resistance measurements, to reduce power dissipation and self-heating in the DUT. With low power On, pressing **Range** displays the lower current sourced for each range:

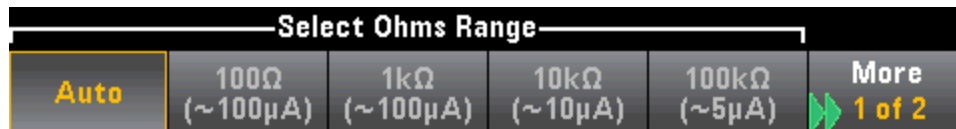

Low-power resistance measurements apply to the 100Ω through 100kΩ ranges only. The 1 MΩ through 1 GΩ ranges source the same current (~.5 μA) regardless of the low-power setting.

Negative Resistance Measurements

Under certain conditions, the instrument may report negative resistance measurements. These may occur in 2-wire and 4-wire resistance measurements or continuity measurements.

Conditions that may cause negative ohms values include:

- Changes in Front/Rear switch contact resistance
- Reversed Sense Hi and Lo leads
- Circuits with external bias or thermal voltages at circuit connections
- Changes in measurement connection after a NULL operation

Under the same conditions, the 34401A returns the measurement's absolute value so as to prevent the confusion associated with negative readings. The Keysight Truevolt Series DMMs will return negative values. This allows the most accurate results after a NULL operation.

Temperature (34460A and 34461A)

This topic applies only to 34460A/61 DMMs. For temperature measurements using the 34465A/70A, see [Temperature \(34465A and 34470A\)](#).

This section describes how to configure 2-wire and 4-wire temperature measurements from the front panel.

Step 1: Configure the test leads as shown.

2-wire Temperature:

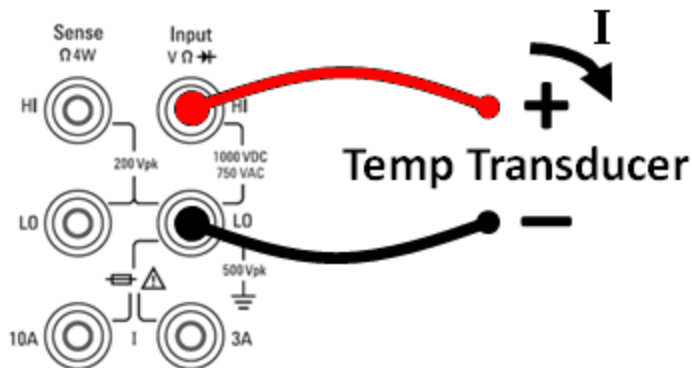

4-wire Temperature:

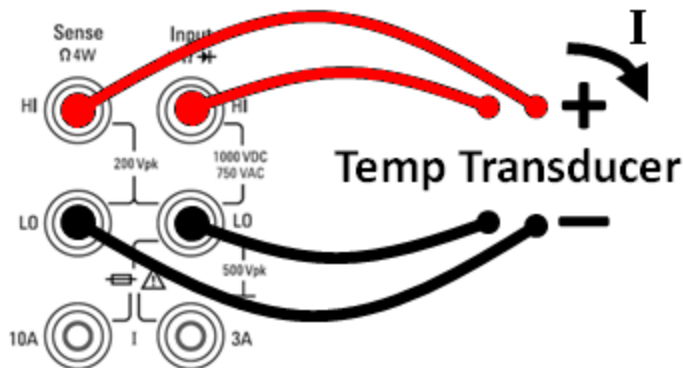

Step 2: Press [Temp] on the front panel. The following menu appears.

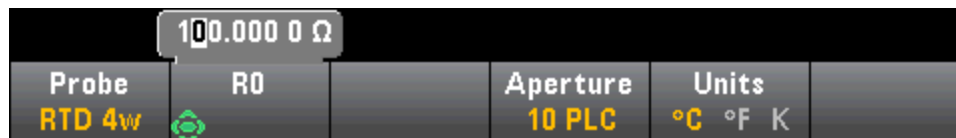

Step 3: Press **Probe** and choose the probe type. If you choose to use an RTD, the menu will have a softkey to specify the RTD's resistance at 0 degrees Celsius (R_0).



Step 4: For 2-wire measurements, an **Auto Zero** softkey is available.

Auto Zero: Autozero provides the most accurate measurements, but requires additional time to perform the zero measurement. With autozero enabled (On), the DMM internally measures the offset following each measurement. It then subtracts that measurement from the preceding reading. This prevents offset voltages present on the DMM's input circuitry from affecting measurement accuracy. With autozero disabled (Off), the DMM measures the offset once and subtracts the offset from all subsequent measurements. The DMM takes a new offset measurement each time you change the function, range, or integration time. (There is no autozero setting for 4-wire measurements.)

Step 5: Press **Aperture** and choose the number of power-line cycles (PLCs) to use for the measurement. Only 1, 10, and 100 PLC provide normal mode (line frequency noise) rejection. Selecting 100 PLC provides the best noise rejection and resolution, but the slowest measurements:



Step 6: Use the **Units** softkey to display temperature in degrees Celsius, degrees Fahrenheit, or Kelvin.

Temperature (34465A and 34470A)

This topic applies only to 34465A/70 DMMs. For temperature measurements using the 34460A/61A, see [Temperature \(34460A and 34461A\)](#).

This section describes how to configure temperature measurements from the front panel. Temperature measurements require a temperature transducer probe. The supported probes are 2-wire and 4-wire RTDs, 2-wire and 4-wire thermistors (5 k Ω 44007 type, see [Thermistor Requirements](#)), and type E, J, K, N, R, or T thermocouples.

NOTE

This section describes general temperature measurement configuration information. For a detailed tutorial on temperature measurements, refer to Keysight Application Note 290 *Practical Temperature Measurements* available at www.keysight.com.

Step 1: Configure the test leads as shown.

2-wire Temperature:

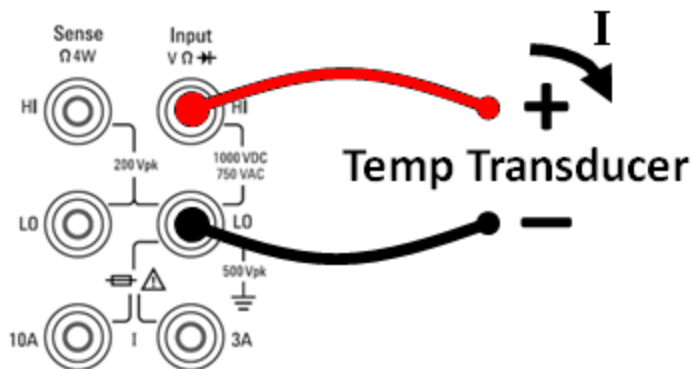

4-wire Temperature:

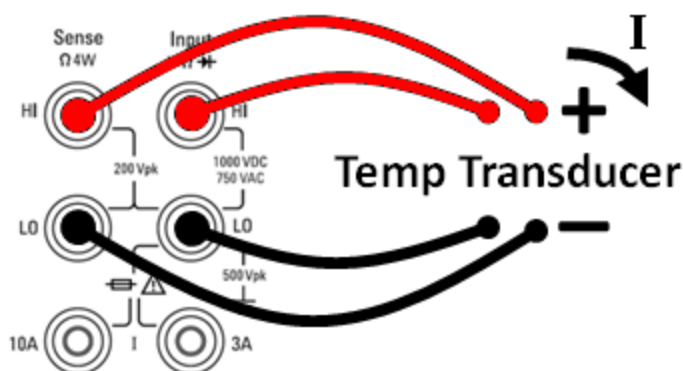

Step 2: Press [Temp] on the front panel.

Step 3: The **Aperture NPLC** softkey is selected by default. Use the up/down arrow keys to specify integration time in power-line cycles (PLCs) to use for the measurement. 1, 10, and 100 PLC provide normal mode (line frequency noise) rejection. Selecting 100 PLC provides the best noise rejection and resolution, but the slowest measurements:



To set integration time precisely, instead of using PLCs, press **Aperture Time** and use the left/right up/down arrow keys to specify integration time in seconds. For **Aperture Time**, you can specify from 200 μ s (20 μ s with the DIG option) to 1 s integration time (2 μ s resolution):



Step 4: Use the **Units** softkey to display temperature in degrees Celsius, degrees Fahrenheit, or Kelvin.

Step 5: Press **Probe Settings**, the default probe settings are:



Step 6: To select another probe type, press **Probe** and press one of the softkeys:

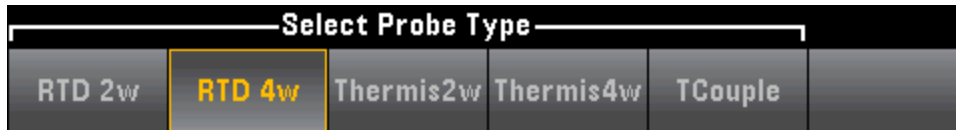

Additional settings for each probe type are described in the sections below.

For the RTD 2w or RTD 4w Probe Type...

The RTD 2w or RTD 4w probe types allow you to set R0 and to enable/disable offset compensation and/or the low-power mode:

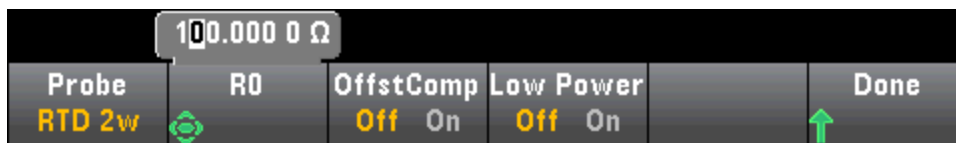

R0: R_0 is the nominal resistance of an RTD at 0 °C. Default 100 Ω

OffstComp Enables or disables offset compensation. Offset compensation removes the effects of small dc voltages in the circuit being measured. The technique involves taking the difference between two resistance measurements, one with the current source set to the normal value, and one with the current source set to a lower value. Enabling Offset Compensation approximately doubles the reading time.

Low Power: Disables (Off) or enables (On) low power measurements. The low power mode sources less test current per measurement range than is normally sourced for standard resistance measurements, to reduce power dissipation and self-heating in the probe.

Press **Done** to return to the main temperature menu.

For the **RTD 2w** probe type, an additional **Auto Zero** setting is available:



Auto Zero: Autozero provides the most accurate measurements, but requires additional time to perform the zero measurement. With autozero enabled (On), the DMM internally measures the offset following each measurement. It then subtracts that measurement from the preceding reading. This prevents offset voltages present on the DMM's input circuitry from affecting measurement accuracy. With autozero disabled (Off), the DMM measures the offset once and subtracts the offset from all subsequent measurements. The DMM takes a new offset measurement each time you change the function, range, or integration time. (There is no autozero setting for 4-wire measurements.)

For the Thermis2w or Thermis4w Probe Type...

The Thermis2w or Thermis4w probe types allow you to enable/disable low power mode:

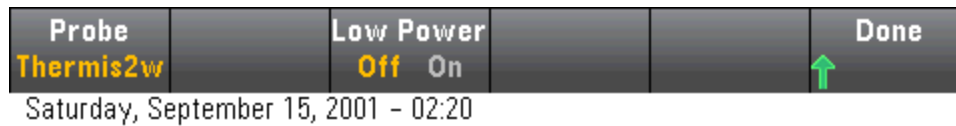

Low Power: Disables (Off) or enables (On) low power measurements. The low power mode sources less test current per measurement range than is normally sourced for standard resistance measurements, to reduce power dissipation and self-heating in the probe.

Press **Done** to return to the main temperature menu. For the **Thermis2w** probe type, an additional **Auto Zero** setting is available:



Auto Zero: Autozero provides the most accurate measurements, but requires additional time to perform the zero measurement. With autozero enabled (On), the DMM internally measures the offset following each measurement. It then subtracts that measurement from the preceding reading. This prevents offset voltages present on the DMM's input circuitry from affecting measurement accuracy. With autozero disabled (Off), the DMM measures the offset once and subtracts the offset from all subsequent measurements. The DMM takes a new offset measurement each time you change the function, range, or integration time. (There is no autozero setting for 4-wire measurements.)

Thermistor Requirements

The DMM converts the measured thermistor resistance to temperature using the Steinhart-Hart thermistor equation:

$$1/T = A + B (\ln(R)) + C (\ln(R))^3$$

Where:

Features and Functions

A, B, and C are constants provided by the thermistor manufacturer and derived from three temperature test points.

R = Thermistor resistance in Ω .

T = Temperature in degrees K.

Important: Use only a 5 k Ω 44007-type thermistor. This type thermistor has constants of $A = 1.285e-3$, $B = 2.362e-4$, $C = 9.285e-8$. Using an incorrect type of thermistor can result in errors greater than 20 °C for a temperature being measured of 100 °C.

For a detailed tutorial on temperature measurements, refer to Keysight Application Note 290 *Practical Temperature Measurements* available at www.keysight.com.

For the TCouple Probe Type...

The **TCouple** probe types allows these settings:

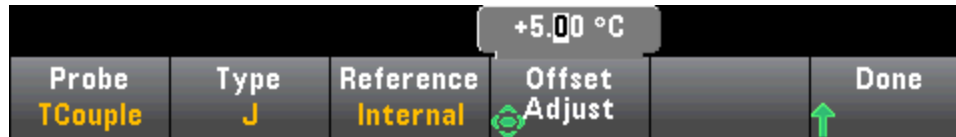

Type: Select the type of thermocouple. Supported types are J (default), K, E, T, N, or R

Reference: Thermocouple measurements require a reference junction temperature. You can input a known fixed reference junction temperature (typically used for external reference junctions) or use the internally measured temperature of the front terminals as the reference junction temperature. Select internal or fixed reference.

Important: Since the internal reference temperature is the temperature of the *front* connections, use of the *rear* connections with the selection of the internal reference junction will have an unknown error with no specified performance and is not recommended.

Offset Adjust: Allows you to make minor temperature adjustments to correct for the differences between the DMM internal temperature measurement of the front connection and the actual temperature of the measurement terminals. When you select the internal reference junction, the internal temperature measurement of the front terminals plus the specified offset value is used as the reference junction temperature. For example, if the measured internal temperature is +20.68 °C and the specified offset is +5 °C, the artificial cold junction mathematics uses the sum of the two values. Keysight recommends that the offset be left at 0 unless metrology has indicated otherwise.

Fixed Offset: When you select the external reference junction, you must specify the reference junction temperature in degrees Celsius. Enter a value from -20 °C to +80 °C. Default: 0 °C. For example, to set the fixed reference temperature to +23.36 °C:

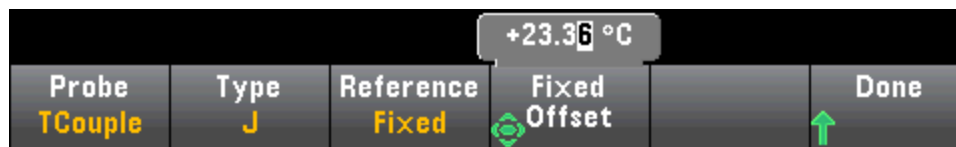

Press **Done** to return to the main temperature menu showing additional settings for thermocouple measurements:

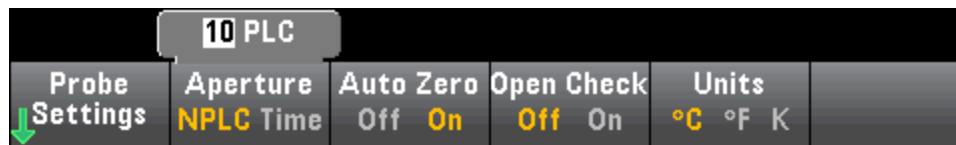

Auto Zero: Autozero provides the most accurate measurements, but requires additional time to perform the zero measurement. With autozero enabled (On), the DMM internally measures the offset following each measurement. It then subtracts that measurement from the preceding reading. This prevents offset voltages present on the DMM's input circuitry from affecting measurement accuracy. With autozero disabled (Off), the DMM measures the offset once and subtracts the offset from all subsequent measurements. The DMM takes a new offset measurement each time you change the function, range, or integration time. (There is no autozero setting for 4-wire measurements.)

Open Check: Disables or enables the *thermocouple check* feature to verify that your thermocouples are properly connected for measurements. When enabled, the instrument measures the resistance after each thermocouple measurement to ensure a proper connection. If an open connection is detected (greater than 5 kΩ on the 10 kΩ range), the instrument reports an overload condition.



For more information about making temperature measurements refer to Keysight Application Note 290 *Practical Temperature Measurements* available at www.keysight.com.

Capacitance

This section describes how to configure capacitance measurements from the front panel.

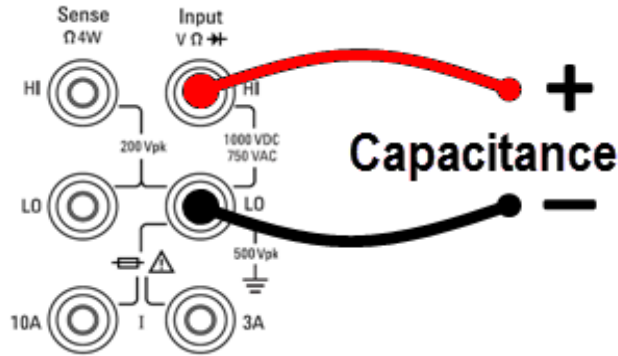
Step 1: Configure the test leads as shown.



Step 2: Press   on the front panel.

Step 3: To null-out the test lead capacitance:

- Disconnect the + and - test leads probe end from the test circuit, and leave open.
- Press **Null**. The DMM will now subtract this null value from capacitance measurements.

Step 4: Press **Range** to select a range for the measurement. You can also use the **[+]**, **[-]**, and **[Range]** keys on the front panel to select the range. (**Auto** (autorange) automatically selects the range for the measurement based on the input. Autoranging is convenient, but it results in slower measurements than using a manual range. Autoranging goes down a range at less than 10% of range and up a range at greater than 120% of range. For capacitance measurements only, when autorange is off, the instrument does not report an overload for readings greater than 120% of range. Overload only occurs when the algorithm times out because the applied capacitance is too large for the algorithm to measure. If you apply a DC voltage or a short to the input terminals in capacitance measurement mode, the instrument reports an overload.



Continuity

This section describes how to configure continuity tests from the front panel.

Step 1: Configure the test leads as shown.

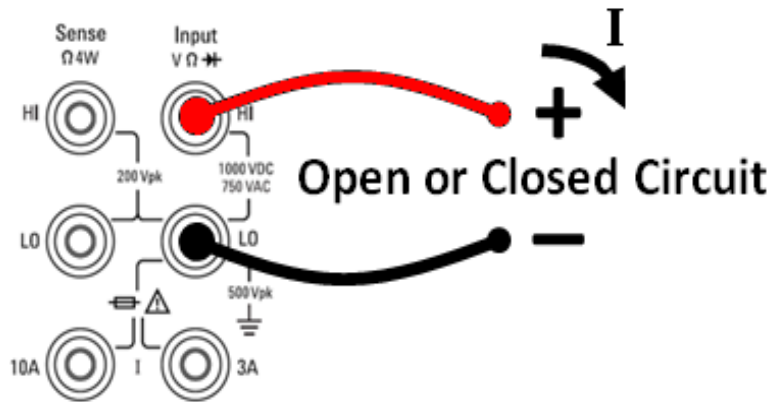

Step 2: Press [**Cont**] on the front panel to open a menu where you can enable or disable the beeper for all functions that use the beeper (limits, probe hold, diode, continuity, and errors).



Continuity measurements behave as follows:

$\leq 10 \Omega$	displays measured resistance and beeps (if beeper enabled)
10Ω to $1.2 \text{ k}\Omega$	displays measured resistance without beeping
$> 1.2 \text{ k}\Omega$	displays OPEN with no beep

Diode

This section describes how to configure diode tests from the front panel. The range and resolution are fixed; the range is 10 VDC (with a 1 mA current source output).

Step 1: Configure the test leads as shown.

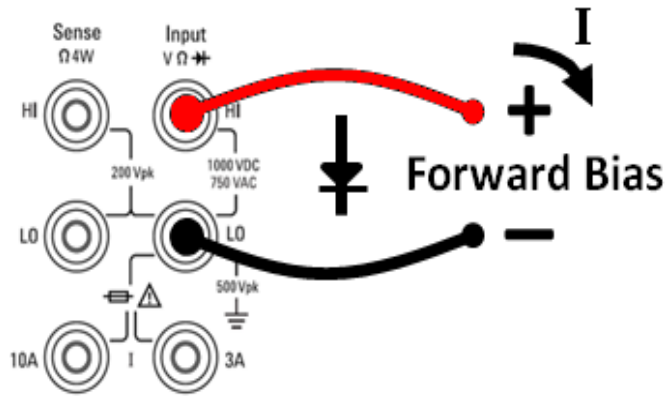

Step 2: Press \rightarrow on the front panel to open a menu that specifies whether the DMM will beep to indicate a successful diode test.



Diode measurements behave as follows:

0 to 5 V	voltage displayed on the front panel, and instrument beeps when signal transitions into the 0.3 to 0.8 V threshold (if beeping is enabled)
> 5 V	the front panel displays OPEN, and SCPI returns 9.9E37

Frequency and Period

This section describes how to configure frequency and period measurements from the front panel.

Step 1: Configure the test leads as shown.

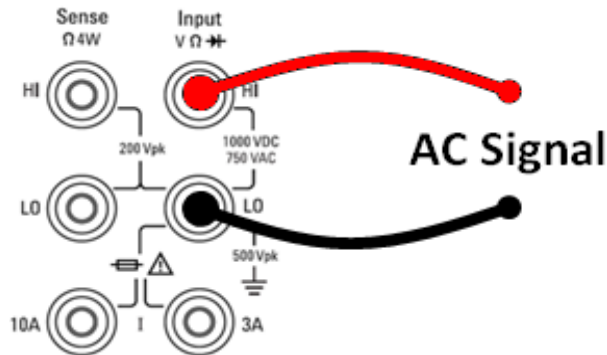

Step 2: Press [**Freq**] on the front panel and then use the first softkey to choose either frequency or period measurement.

Freq Period	Range Auto	AC Filter >20Hz	Gate Time 100ms	Timeout 1s	
-----------------------	----------------------	---------------------------	---------------------------	----------------------	--

Step 3: Press **Range** to select a range for the measurement. (**Auto** (autorange) automatically selects the range for the measurement based on the input. Autoranging is convenient, but it results in slower measurements than using a manual range. Autoranging goes up a range at 120% of the present range, and down a range below 10% of the present range.

Select Frequency Voltage Range					
Auto	100mV	1V	10V	100V	750V

Step 4: Press **AC Filter** and choose the filter for the measurement. The instrument uses three different AC filters that enable you either to optimize low frequency accuracy or to achieve faster AC settling times following a change in input signal amplitude.

The three filters are 3 Hz, 20 Hz, and 200 Hz, and you should generally select the highest frequency filter whose frequency is less than that of the signal you are measuring, because higher frequency filters result in faster measurements. For example, when measuring a signal between 20 and 200 Hz, use the 20 Hz filter.

If measurement speed is not an issue, choosing a lower frequency filter may result in quieter measurements, depending on the signal that you are measuring.

Select AC Filter					
>3Hz	>20Hz	>200Hz			

Step 5: Press **Gate Time** and choose the measurement aperture (integration time) of 1 ms (34465A/70A only) 10 ms, 100 ms (default), or 1 s.



Step 6: (34465A/70A only) Press **Timeout** to control how long the instrument waits before timing out on a frequency or period measurement when no signal is present. When set to 1 s, the instrument waits 1 second before timing out. When set to Auto, the wait time varies with AC filter bandwidth; for the faster bandwidths, the instrument waits a shorter time before timing out and returning 0.0. This is advantageous in manufacturing test systems where a DUT failure may result in no signal; in this case, the failure can be detected sooner, speeding up test throughput.



NOTE For accurate displayed statistics of AC measurements in Front Panel mode, the default manual trigger delay ([Acquire] > Delay Man) must be used.

Data Logging

The Data Log mode is standard on the 34465A and 34470A only, as is available only from the DMM's front panel. Data Log mode provides a front-panel user interface that allows you to set up data logging into the instrument's non-volatile memory, or to internal/external file(s), without programming, and without a connection to a computer. Once you have finished collecting data, you can view it from the front panel, or you can transfer the data to your computer. Data Log mode allows you to log a specified number of readings, or readings acquired for a specified period of time, to instrument memory or to internal or external data files.

To select Data Log mode, press **[Acquire] Acquire > Data Log**. You can then select the Sample Interval (time between measurements - for example, 500 mS), Duration as either an amount of Time or a number of Readings, whether to Start after a Delay or at a specific Time of Day, and whether to Log to Memory or Log to File(s). After configuring the data logging parameters, press **[Run/Stop]**. Data logging will begin following the specified Delay or at the specified Time of Day.

Data Log mode can be used with the DC voltage, DC current, AC voltage, AC current, 2-wire and 4-wire resistance, frequency, period, temperature, capacitance, and ratio measurement functions (diode and continuity are excluded). The maximum reading rate is 1000 readings/s and the maximum duration is 100 hours resulting in a maximum number of readings of 360,000,000 to file. The number of readings you can log to memory depends on the amount of instrument memory. With the MEM option, the limit is 2,000,000 readings; without the MEM option, the limit is 50,000 readings. By default, data logging implements auto trigger. The level and external trigger sources are not supported for data logging.

CAUTION

Loss of data possible - local to remote transition clears instrument memory: When data logging or digitizing *to memory*, if you access the instrument from remote (send a SCPI or common command)* and then return to local (by pressing **[Local]**), the readings in memory are cleared and the instrument returns to Continuous mode.

For data logging only, you can prevent this situation by data logging to a file instead of to memory (see [Data Log Mode](#) for details). You can also prevent this from happening for data logging or digitizing by taking steps to keep the instrument from being accessed from remote. To prevent remote access, you may want to disconnect the LAN, GPIB, and USB interface cables from the instrument before starting the measurements. To prevent remote access via LAN, you can connect the instrument behind a router to minimize the possibility of remote access. You can also disable the various I/O interfaces from the front panel menus under **[Utility] > I/O Config**.

To view the status of a data logging or digitizing operation remotely, use the instrument's [Web User Interface](#). The Web User Interface monitor does not set the instrument to remote.

**When accessed from remote, the instrument will continue data logging or digitizing to completion, and you can retrieve the readings from remote.*

Data Logging Overview

This section is a summary of the steps involved in setting up data logging. Detailed steps are described below in Detailed Data Logging Steps.

Features and Functions

1. Select the measurement function and make connections to the DUT (see [Measurements](#) for details).
2. Select Data Log mode (press [**Acquire**] > **Acquire** > **Data Log**).
3. Specify the sample interval (time between readings) for example, 20 mS.
4. Specify the duration as amount of time or number of readings.
5. Specify when to start data logging (delay or time of day). You can only use auto trigger (default) or single trigger (press [**Single**]) for data logging.
6. Select whether to log data to memory or internal or external data file(s).
7. Press [**Run/Stop**] or [**Single**]. Data logging starts when the specified delay has elapsed or the time of day occurs (specified in Step 5). Data logging will stop after the specified duration (time or number of readings) has occurred or after you press [**Run/Stop**] again.

Detailed Data Logging Steps

Note: For more information, on any of the softkeys described below, such as the range of values for a particular setting, press and hold the softkey to display help for that softkey.

Step 1: Select the measurement function and make connections to the DUT (see [Measurements](#) for details). For example, press **DCV** and configure the test leads as shown.

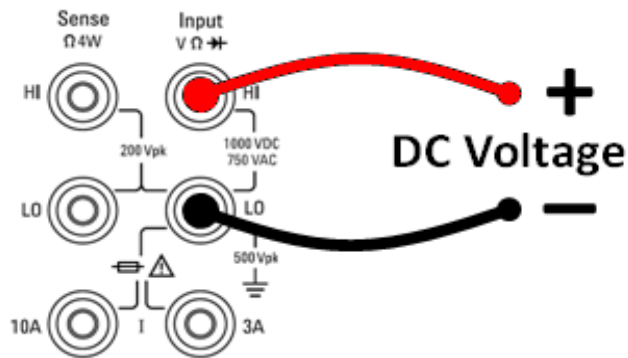

Step 2: Press [**Acquire**] on the front panel to display these softkeys:

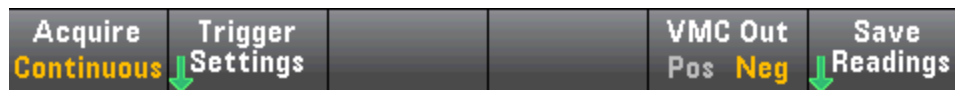

Press the **Acquire** softkey.



Press the **Data Log** softkey. The Data Log menu opens:



Step 3: Press **Sample Interval** and specify the time interval between samples (readings).

Note: You may see this message when configuring data logging: *Sample interval is limited by measurement settings*. The measurement time is determined by the measurement function, NPLC, Aperture, Autorange, Autozero, Offset Compensation, AC Filter, TC Open Check, and Gate Time. The data logging Sample Interval cannot be less than the measurement time. You can shorten the measurement time by selecting less integration time, selecting a fixed range, and so on.



Step 4: Press the **Duration** softkey to specify the length of time to log data, or, press **Duration** again to specify the total number of readings to log.

Step 5: Press **Start** to specify when to start data logging. You can select:

- **Start Delay** - Starts data logging after a specified time delay. Specified in HH.MM.SS format.
- **Start Time of Day** - Starts data logging at a specified time of day. Specified in HH.MM.SS format. Using the time of day requires that the instrument's real-time clock is properly set. To set the clock, press **[Shift]** > **[Utility]** > **System Setup** > **Date/Time**.



NOTE You cannot configure a trigger source when data logging. You can only use auto trigger (selected by default) or, when ready to initiate data logging, you can cause a single trigger (by pressing **[Single]**). The effect is the same, as you only need one auto trigger or single trigger event to enable data logging.

Step 6: Press **Log To** > **Log To Memory** or **Log To Files** to specify whether the data logging results will be stored in volatile memory for display or written to one or more internal/external files.

- When data logging to memory, the data is volatile (not remaining during power off) but can be saved to an internal or external file after data logging is complete (see Step 7 below). The number of readings you can store in memory depends on the amount of instrument memory. With the MEM option, the limit is 2,000,000 readings. Without the MEM option, the limit is 50,000 readings.

- When data logging to file(s), **Browse** to an internal or external path and specify a **File Name**. If more than one file needs to be created to hold the data, the second file name will be appended with _00001, the third file name with _00002, and so on. When data logging to files, the maximum number of readings is 360,000,000.

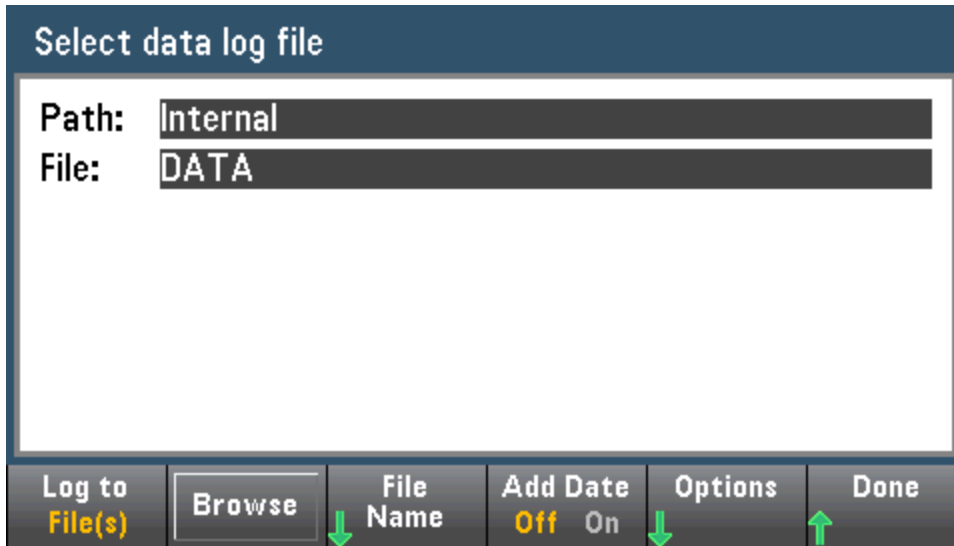

When **Add Date** is **On**, the data logging start date and time is appended to the file name using the format:

`_YYYYMMDD_HHMMSS`

For example, for a file named *Data 1*, the result will be similar to: *Data 1_20140720_032542*.

Press **Options** to to configure reading storage options:



Rows/File - Specifies the maximum number of rows or readings to be written to a file. For **Max**, the limit is the number of bytes allowed by the file system ($2^{32} = 4.294967296$ GBytes). This represents approximately 252 M readings with Metadata Off, or 159 M readings with Metadata On. For **1M**, the limit is 1,000,000 rows in the resulting file. This allows you to accommodate common spreadsheet, database and data analysis programs that have limitations of 1 million rows per file.

Metadata - Enables reading number, time stamp of first reading, and sample interval (if available) in the file.

Separator - Specifies the character (Comma, Tab, or Semicolon) to use for separating the information on each row.

When finished configuring reading storage, press **Done** > **Done** to return to the main data logging menu.

Step 7: Press **[Run/Stop]** or **[Single]**. Data logging starts when the specified delay has elapsed or the time of day occurs (specified in Step 5). Data logging will stop after the specified duration (time or number of readings) has occurred or after you press **[Run/Stop]** again.

When data logging is complete:

- When data logging to file(s), the instrument saves the file(s) with the specified name and path.
- When data logging to memory, you can now save the readings from the main data log menu by pressing **Save Readings**.



You can then **Browse** to an internal or external path and specify a **File Name**. You can also specify reading storage **Options** as described above in Step 6.

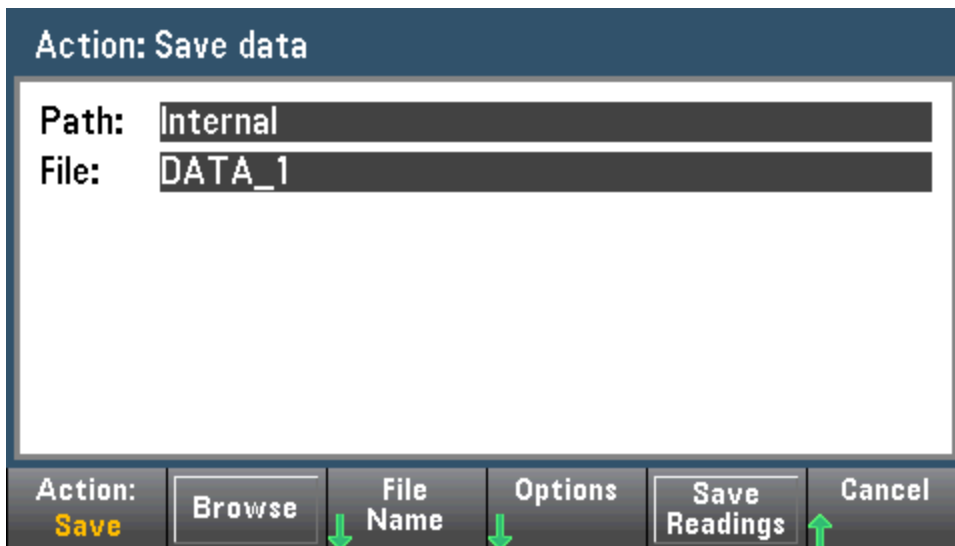

Trend Chart for Data Logging

The Trend Chart is particularly useful for viewing data logging measurements. See [Trend Chart \(Digitize and Data Log Modes\)](#) for details.

Digitizing

The digitizing feature (applies only to the 34465A/70A with the DIG option) provides a front-panel user interface that allows you to quickly set up digitized measurements. Digitizing is the process of converting a continuous analog signal, such as a sine wave, into a series of discrete samples (readings):

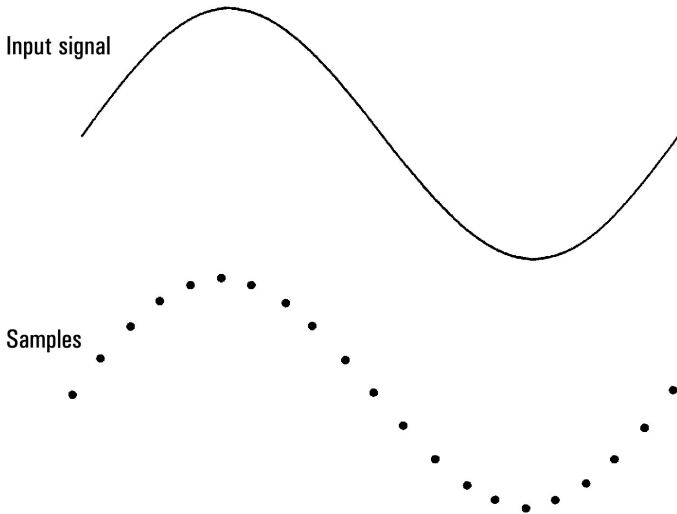

See [Digitizing Measurements](#) for a tutorial on digitizing and more information on samples rates vs. input frequencies.

The DMM digitizes by sampling the input signal using either the DCV function (default) or the DCI function with autorange and autozero disabled.

CAUTION

Loss of data possible - local to remote transition clears instrument memory: When data logging or digitizing *to memory*, if you access the instrument from remote (send a SCPI or common command)* and then return to local (by pressing [**Local**]), the readings in memory are cleared and the instrument returns to Continuous mode.

For data logging only, you can prevent this situation by data logging to a file instead of to memory (see [Data Log Mode](#) for details). You can also prevent this from happening for data logging or digitizing by taking steps to keep the instrument from being accessed from remote. To prevent remote access, you may want to disconnect the LAN, GPIB, and USB interface cables from the instrument before starting the measurements. To prevent remote access via LAN, you can connect the instrument behind a router to minimize the possibility of remote access. You can also disable the various I/O interfaces from the front panel menus under [**Utility**] > **I/O Config**.

To view the status of a data logging or digitizing operation remotely, use the instrument's [Web User Interface](#). The Web User Interface monitor does not set the instrument to remote.

*When accessed from remote, the instrument will continue data logging or digitizing to completion, and you can retrieve the readings from remote.

Digitizing Overview

This section is a summary of the steps involved in setting up digitizing. Detailed steps are described below in Detailed Digitizing Steps.

1. Select DCV or DCI measurements and connect to the DUT.
2. Select Digitize mode (press [**Acquire**] > **Acquire** > **Digitize**).
3. Specify the sample rate (for example, 50 kHz) or sample interval (for example, 20 μ S).
4. Specify the duration as amount of time or number of readings.
5. Select trigger source (Auto, Ext, or Level).
 - a. For external, specify polarity.
 - b. For level, use Range +/- to select fixed range, then specify threshold and polarity.
6. Specify delay time or use auto.
7. Optional: If using the level or external trigger source, specify a pretrigger count (number of readings to store before the trigger event occurs).
8. Press [**Run/Stop**]. Digitizing starts when the trigger event occurs and stops after duration or when you press [**Run/Stop**] again.
9. Save the digitized data to a file.
10. Optional: select trend chart to view digitized data.

NOTE

The histogram and statistics functions can be used when digitizing. However, this data will not be updated until digitizing is complete.

Detailed Digitizing Steps

Step 1: To digitize DC voltage, press **DCV** and configure the test leads as shown.

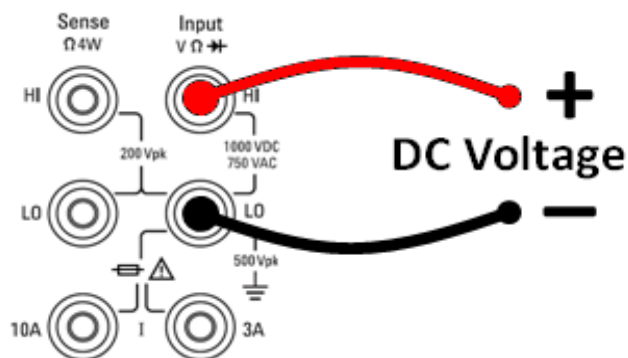

To digitize DC current, press **DCI** and configure the test leads as shown.

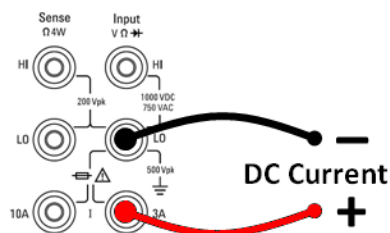

Features and Functions

On the 34461A/65A/70A, you can also configure the measurement using the 10 A terminal, which is recommended when measuring current above 1 A:

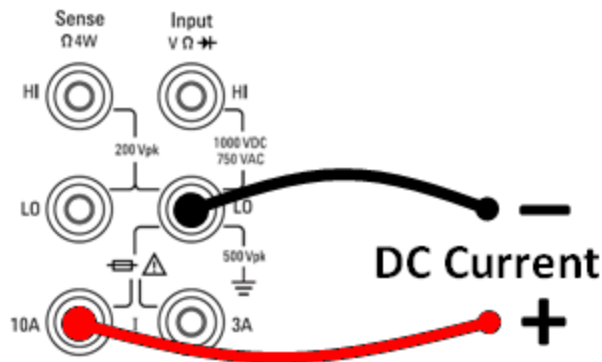

Step 2: Press [**Acquire**] on the front panel and then press the **Acquire** softkey:

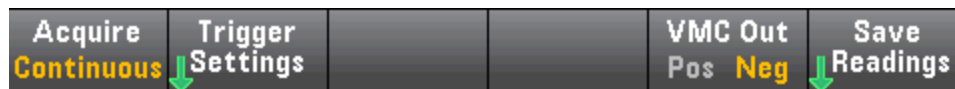

Press the **Digitize** softkey:



Step 3: The Digitize menu opens:



With **Sample Rate** selected, use the up/down arrow keys to select a sample rate in samples per second (Hz), or press the **Sample Rate** softkey to specify a sample interval (time between samples):



Step 4: Press the **Duration** softkey to specify the length of time to digitize:



or, press **Duration** again to specify the total number of samples to digitize:



Step 5: Press **Trigger Settings** to view or change the trigger source. By default, the trigger source is set to auto. You can also select external and level triggering when digitizing.



Press **Trg Source** and select one of three trigger sources:



Auto - the instrument automatically triggers immediately after you press **[Run/Stop]** or **[Single]**.

Step 5a Configure external triggering: After pressing **Ext**, this menu appears:



Ext - the instrument triggers when an edge of the appropriate slope arrives at the rear-panel Ext Trig connector. You can specify the slope on the softkey menu that appears when **Trg Src** is set to Ext. To select external triggering, press **Ext**, and select either Pos or Neg slope:

Step 5b Select level trigger: Level - (34465A/70A with DIG option only) the instrument issues one trigger when the specified measurement threshold with the specified positive or negative slope occurs. To select level triggering, press **Level** and specify the level threshold and Pos or Neg slope:

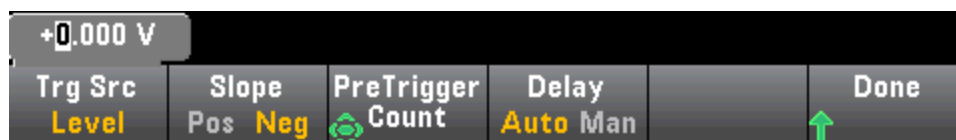

NOTE Select the expected measurement range using the **[Range] [+]** and **[-]** keys before setting the level trigger voltage or current.

Step 6: Specify delay time

Specify the delay that occurs prior to digitizing. This delay is inserted once, after the trigger event occurs, and before digitizing begins. This can be automatic (the instrument chooses the delay based on the instrument's settling time) or manual (you specify the delay time).

Step 7: (Optional) Specify pretrigger count.

When an External or Level Trigger Source is used, you can specify a pretrigger count. After specifying a pretrigger count, readings are taken and held in a buffer while waiting for the trigger event to occur. When the trigger event occurs, the buffered readings are transferred to reading memory and the remaining readings

are recorded as usual. If the trigger event occurs before Pretrigger Count readings have been taken, the trigger event will still take effect and digitizing will complete without having taken all of the pretrigger readings. The Pretrigger Count is limited to one less than the total number of readings specified to be taken by the Duration setting.

Step 8: Press [Run/Stop] to start the digitizing process. Digitizing will begin when the specified trigger event occurs and after the specified delay has elapsed. **Digitizing** is displayed at the top of the display while digitizing; when finished, **Digitize Stopped** is displayed.

Step 9: All readings taken during digitizing are saved in volatile memory, when digitizing is finished, press the **Save Readings** softkey to specify a file location and save the readings.

Step 10: (Optional) Press **Display > Display Trend** to view the trend chart. The Trend Chart is particularly useful for viewing and analyzing digitized measurements. X and Y cursors (shown below), tracking cursors, pan control, and zoom allow you to analyze digitized data. See [Trend Chart \(Digitize and Data Log Modes\)](#) for details.

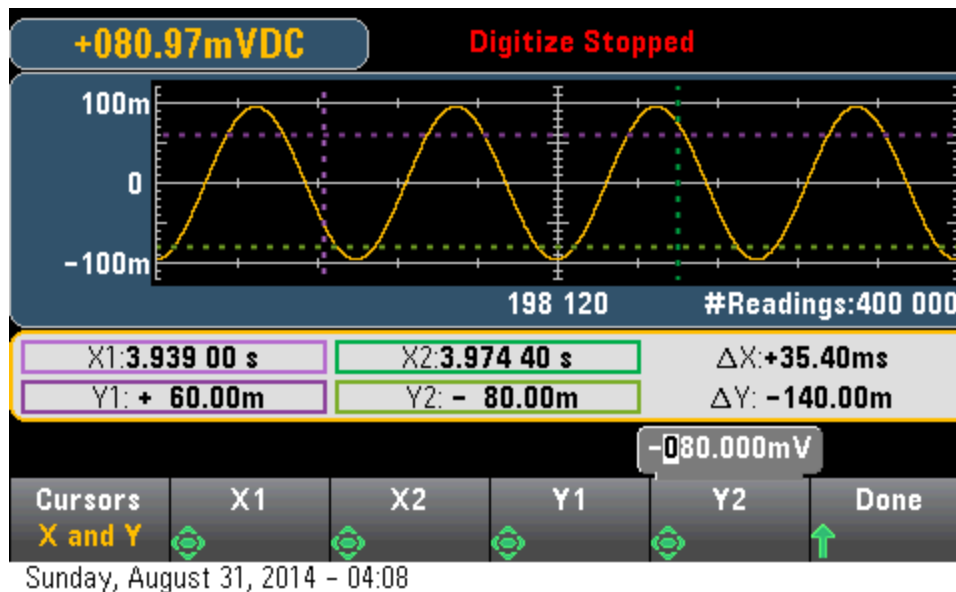

Level Triggering

Level triggering is available only on the 34465A/70A with the DIG option. Level triggering allows you to trigger measurements at some defined point on the input signal, such as when the signal crosses zero volts or when it reaches the midpoint of its positive or negative peak amplitude. For example, this graphic shows sampling beginning as the input signal crosses 0V with a positive slope:

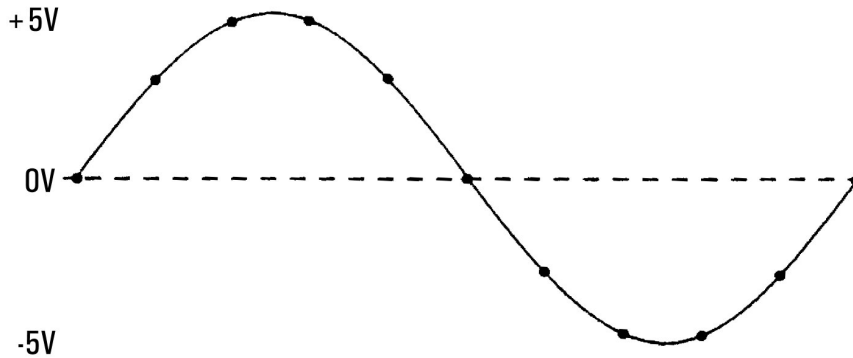

About Level Trigger

Level triggering is available for these measurement functions:

- DC voltage and DC current
- AC voltage and AC current
- 2-wire and 4-wire resistance with offset compensation off, and low power off
- Temperature, RTD or thermistor sensors only
- Frequency and period

The level trigger is edge-sensitive. That is, the instrument must detect a *change* in the quantity being measured from one side of the level setting to the other side (direction controlled by Slope setting). For example, if the Slope is positive, then the quantity being measured must first reach a value *below* the set level before a trigger event can be detected.

Level trigger performance is not uniform. Its accuracy, latency, and sensitivity are dependent on other DMM features. These dependencies vary by measurement function as described below.

DC voltage, DC current, and 2-wire resistance considerations

These measurement functions can use a fast-response detector built into the hardware for fixed-range measurements. For lowest latency and highest sensitivity, use a fixed range when using level trigger. However, trigger level accuracy is reduced when the hardware detector is used.

To increase trigger level accuracy and reduce sensitivity (avoid false triggers due to noise), use autorange:

- When auto-range is enabled, trigger level accuracy is increased, latency is increased, and sensitivity is decreased as the aperture or NPLC setting is increased.

Features and Functions

- When auto-range is enabled, trigger level accuracy is increased, latency is increased, and sensitivity is decreased if autozero is enabled.
- When auto-range is enabled, range changes may be made while waiting for the trigger crossing which can cause additional latency/uncertainty.

4-wire resistance and temperature considerations

- Trigger level accuracy is increased, latency is increased, and sensitivity is decreased as aperture or NPLC is increased.
- Fixed range (only available for resistance) eliminates uncertainties (due to range change) in trigger latency.

AC voltage and AC current considerations

- Trigger latency is increased, and sensitivity is decreased as filter bandwidth is increased.
- Trigger latency can be controlled by trigger delay setting.
- Fixed range eliminates uncertainties (due to range change) in trigger latency.
- Autorange uncertainties become worse as filter bandwidth is increased.

Frequency and period considerations

- Trigger level accuracy is increased, latency is increased, and sensitivity is decreased as gate time is increased.
- Fixed voltage range eliminates uncertainties (due to range change) in trigger latency.

Secondary Measurements

Most measurement functions allow you to select and display a secondary measurement function. Secondary measurements can be displayed in the Number and Bar Meter displays only. For example, a thermistor temperature measurement (primary) and the resistance measurement made on the thermistor (secondary) are shown below:

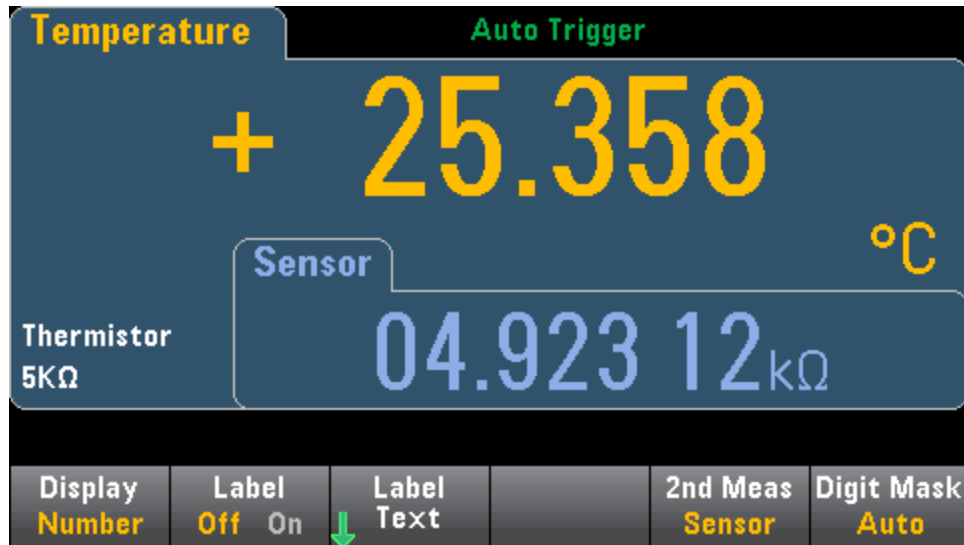

To select a secondary measurement from the front panel, first select the primary measurement function and then press **Display**:

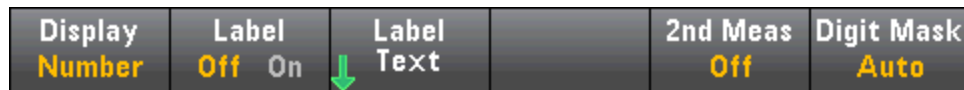

Press **2nd Meas** and select the secondary measurement.

The primary measurement functions and their associated secondary measurements for each DMM model are:

Primary Measurement Function	34460A/61A Secondary Measurement Function	34465A/70A Secondary Measurement Function
DCV	ACV ¹	ACV ¹ , Peak, Pre-Math
ACV	Frequency	DCV ¹ , Frequency, Pre-Math
2-Wire, 4-Wire Resistance		Pre-Math
DCI	ACI ¹	ACI ¹ , Peak, Pre-Math
ACI	Frequency	DCI ¹ , Frequency, Pre-Math
Frequency	Period	Period, ACV, Pre-Math
Period	Frequency	Frequency, ACV, Pre-Math
Temperature	Sensor	Sensor, Pre-Math
Ratio	Input/Ref	Input/Ref, Pre-Math
Capacitance		Pre-Math
Cont		None
Diode		None

Where:

- Pre-Math - The measurement value before any math operations are done (including NULL).
- Sensor - The raw sensor value; ohms for thermistor/RTD, volts for thermocouple (thermocouple measurements apply to the 34465A and 34470A only).
- Input/Ref - The DC signal voltage and the DC reference voltage measurements.
- Peak - Displays a running history of the minimum peak, maximum peak, and peak-to-peak values of the input signal. Peak measurements are high-speed (16 μ s effective aperture) and are different from the Min, Max, and Peak-to-Peak values gathered in Statistics.

¹ After making one or more primary measurements for approximately 4 seconds, the DMM makes one secondary measurement.

For the Peak secondary measurement, the **Clear Peaks** softkey allows you to clear the accumulated history of the peak-to-peak function (resets the record of peak values).



Triggering and Readings

The trigger model and large reading memory on the Truevolt Series DMMs provide versatile capabilities for a wide variety of applications.

Instrument trigger model

Acquiring measurements on the DMM is done as the result of triggering. This section describes how to configure triggering for the Continuous measurement mode. For the 34465A/70A, refer to [Digitizing](#) and [Data Logging](#) for information on triggering in those measurement modes.

For the 34460A/61A, pressing [**Acquire**] opens the following menu:



For the 34465A/70A, pressing [**Acquire**] opens the following menu:



Press **Trigger Settings** to open the following menu:



The menus above allow you to configure measurement triggering, and you can also use the **VMC Out** softkey to set the edge slope of the **VM Comp** (voltmeter complete) output on the instrument's rear panel. This connector issues a signal whenever the voltmeter finishes taking a measurement to allow you to signal other devices in a measurement system.

NOTE For accurate displayed statistics of AC measurements in Front Panel mode, the default manual trigger delay (**[Acquire] > Delay Man**) must be used.

The (**Trg Src**) menu allows you to select one of these trigger sources:



Auto - the instrument continuously takes measurements, automatically issuing a new trigger as soon as a measurement is completed.

Single - the instrument issues one trigger each time the front panel [**Single**] key is pressed.

Ext - (Ext requires LAN option on 34460A) the instrument issues one trigger each time an edge of the appropriate slope arrives at the rear-panel Ext Trig connector. You can specify the slope on the softkey menu that appears when **Trg Src** is set to Ext.

Level - (34465A/70A with DIG option only) the instrument issues one trigger when the specified measurement threshold with the specified positive or negative slope occurs.

In the Single, Ext, and Level modes, you can specify the number of samples to be taken per trigger by using the **Samples/Trigger** softkey. The Single and Ext modes can both buffer up to one trigger, meaning that if you press **[Single]** or receive an external trigger while a series of measurements is in progress, the instrument will finish that series of measurements and then immediately launch a new series of measurements based on the trigger.

If multiple **[Single]** or external triggers are issued during a series of measurements, all triggers received after the first are discarded.

The **[Acquire]** menu also configures the delay that occurs before each measurement is taken, regardless of the trigger mode (Auto, Single, or Ext). This may be either automatic (the delay is based on the DMM's settling time) or manual (you specify the delay time).

Finally, note the **[Run/Stop]** and **[Single]** keys on the front panel. In Auto trigger mode, pressing **[Run/Stop]** stops and resumes measurements, and pressing **[Single]** switches the instrument to single trigger mode. In the Single and Ext modes, pressing **[Run/Stop]** stops readings if they are in progress, or switches the mode to Auto if readings are stopped.

Trigger delay and multiple samples

The instrument inserts a trigger delay between the occurrence of a trigger and the first measurement. When **Auto** is used (**Delay Auto** softkey), the instrument automatically determines the delay based on function, range and integration time. See [Automatic Trigger Delays](#) for further information. However, you may need to manually set a delay (**Delay Man** softkey) longer than the automatic delay to allow the input to settle before pacing a burst of measurements, for measurements with long cables, or for measurements of high capacitance or high impedance signals.

If you have configured the instrument for more than one sample per trigger (**Samples/Trigger** softkey), in all cases, the first sample is taken one trigger delay time after the trigger occurs. Beyond that, sample timing depends on whether you select immediate (**Sample Immediate** softkey, default) or timer (**Sample Timer** softkey) as described below.

- **Sample Immediate** - The first sample starts one trigger delay time after the trigger, and then the trigger delay time is inserted between successive samples:

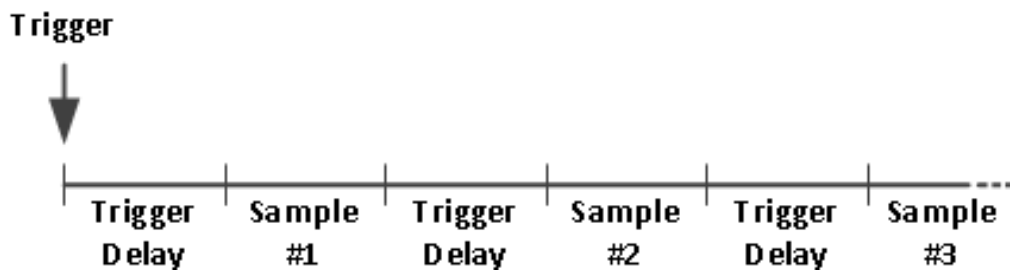

In this configuration, the sample timing *is not* deterministic because the delay time is inserted after each sample completes. The actual time required to take each sample depends on the integration time and autoranging time.

- **Sample Timer** - The first sample starts one trigger delay time after the trigger. The second sample starts one sample interval after the start of the first sample, and so on:

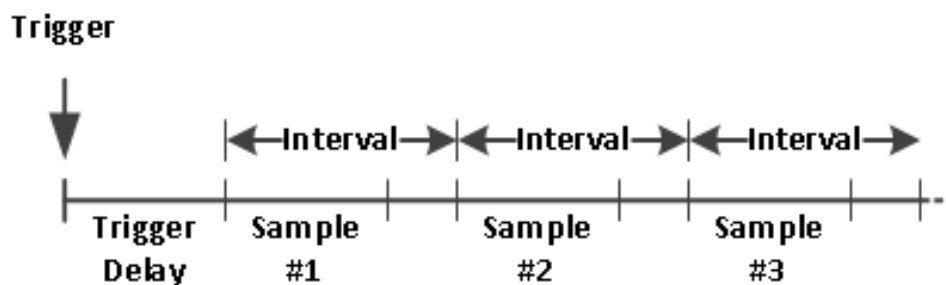

In this configuration, the sample timing *is* deterministic because the start of each sample is determined by the specified sample interval (the trigger delay affects only the start of the first sample). Integration time and autoranging affect the sampling time for each sample, but not the sample interval. Periodic sampling continues until the sample count (set with the **Samples/Trig** softkey) is satisfied.

NOTE

From the front panel, the instrument prevents you from specifying a sample timer that is shorter than the time required to make measurements based on the present function, range, and integration time.

Storing and clearing readings

You can store up to 1,000 measurements in the reading memory of the 34460A, 10,000 measurements on the 34461A, 50,000 measurements on the 34465A/70A (*without* the MEM option), or 2,000,000 measurements on the 34465A/70A (*with* the MEM option). Readings are stored in a first-in, first-out (FIFO) buffer; when reading memory is full, the oldest readings are lost as newer readings are taken.

In Local (front panel) mode, the instrument collects readings, statistics, trend chart and histogram information in the background, so if you select any of those options, the data is ready for viewing. In Remote (SCPI) mode, the instrument does not collect this information by default.

Changing the instrument from Local to Remote does NOT clear any readings in memory. Changing the instrument from Remote to Local DOES clear any readings in memory.

In general, you turn the reading of measurements on and off by pressing **[Run/Stop]**, as described above. You can also take one reading or a specified number of readings by pressing **[Single]**.

To save readings, press **[Acquire] > Save Readings**. Then use the menu that appears to configure the location where you want to save the readings:



See [Utility Menu - Manage Files](#) for details.

For the 34460A/61A only, press **Save Readings** to save the readings in memory to a file.

For the 34465A/70A only, press **Options** to configure reading storage options:



Rows/File - Specifies the maximum number of rows or readings to be written to a file.

- For **Max**, the limit is the number of bytes allowed by the file system ($2^{32} = 4.294967296$ GBytes). This represents approximately 252 M readings with Metadata Off, or 159 M readings with Metadata On.
- For **1M**, the limit is 1,000,000 rows in the resulting file. This allows you to accommodate common spreadsheet, database and data analysis programs that have limitations of 1 million rows per file.

Metadata - Enables reading number, time stamp of first reading, and sample interval (if available) in the file.

Separator - Specifies the character (Comma, Tab, or Semicolon) to use for separating the information on each row.

When finished configuring reading storage, press **Done > Save Readings** to save the readings in memory to a file.

Clearing Reading Memory

The following actions clear reading memory:

- Changing the measurement function
- Pressing any **Clear Readings** softkey
- Transitioning in or out of Probe Hold
- Changing temperature units
- Changing any dB/dBm parameters
- Changing any histogram binning parameter
- Changing the temperature probe or R_0
- Recalling a stored state
- Calibrating the instrument
- Switching between 3 A and 10 A inputs
- Changing the position of the Front/Rear switch
- Transferring from Remote to Local mode
- Turning Null on or off or changing the Null value

These actions do not clear reading memory:

- Changing measurement parameters, such as range and aperture.
- Turning limits on or off, or adjusting limit values
- Pressing [**Run/Stop**] in front panel auto trigger mode
- Changing the trend chart **Recent/All** softkey (34461A/65A/70A only)
- Changing samples per trigger or trigger delay
- Changing display modes
- Changing the **VM Comp** output polarity
- Changing the digit mask
- Changing the histogram, bar meter, or trend chart scale
- Changing user preferences
- Executing self-test

Probe Hold

Because probing small areas requires careful concentration, it is often difficult to read the instrument display while taking measurements. Therefore, the instrument includes a front panel [**Probe Hold**] key that allows you to take readings without viewing the display. You can generate up to eight readings and hold them on the display for later viewing. These readings may be of different measurement types and you may clear displayed readings at any time.



In Probe Hold mode, the instrument optimizes measurement settings to allow reliable detection of stable signals (these settings are restored to their original values when you exit Probe Hold.) When you probe a signal, the instrument beeps (if the beeper is enabled) and automatically records a measurement when it finds a series of stable readings. You may take additional readings without pressing [**Probe Hold**] again.

Press **Remove Last** to remove the last reading from the list. Press **Clear List** to remove all readings from the list.

Because the Probe Hold display is optimized for the Probe Hold readings, you may not combine it with other display modes, such as histogram, bar graph, trend chart, or statistics.

Probe Hold is a front panel only function. Readings recorded in Probe Hold mode cannot be accessed from remote. You can, however, take a screen capture of the probe hold display, see [Utility Menu - Manage Files](#) for details.

Math - Introduction

The **[Math]** key is the shifted **[Null]**:



These math functions are available for the 34460A/61A:



- [Null](#)
- [dB/dBm Scaling](#)
- [Statistics](#)
- [Limits](#)

These math functions are available for the 34465A/70A:



- [Null](#)
- [Smoothing Filter](#)
- [Scaling](#)
- [Statistics](#)
- [Limits](#)

Math - Null

A null reading is a value that is subtracted from all subsequent measurements. The value is specific to the present function and will persist even if you leave this function and return to it later.

One common use of this feature is to remove lead resistance from a resistance measurement. To do this, simply short the test leads together and press **[Null]**. For other measurement functions, place the probes across a null value circuit before pressing **[Null]**.

You can also specify a null value by pressing **[Math]**, changing the first softkey to **Value**, and entering the value using the arrow keys. To turn off the null feature, press **[Null]** again or press **[Math]** and set the first softkey to **Off**.



See Also

[Math - Introduction](#)

[dB/dBm Scaling](#)

[Statistics](#)

[Limits](#)

Math - dB/dBm Scaling

NOTE

This topic describes dB/dBm Scaling for the 34460A/61A. Scaling features are different for the 34465A/70A and are described in the [Scaling](#) topic.

The dB and dBm scaling functions, which apply to ACV and DCV measurements only, allow you to scale measurements relative to a reference value.

NOTE

Scaling is set to OFF when you change measurement functions (for example, changing from DCV to ACV). You must re-enable scaling after changing measurement functions.

Front Panel Menus

The dB and dBm functions are accessed from the second softkey in the **[Math]** menu.



When the first softkey in the dB / dBm menu is enabled, as shown below, you will see one of the following menus:

When function is dB:



When function is dBm:



dB Scaling

Each dB measurement is the difference between the input signal and a stored reference value, with both values converted to dBm:

$$\text{dB} = \text{reading in dBm} - \text{reference value in dBm}$$

The relative value must be from -200 to +200 dBm (default 0). You can either measure this value by pressing **Measure Ref Value**, or you can enter a specified value.

dBm Scaling

The dBm function is logarithmic, comparing power delivered to a reference resistance, relative to 1 milliwatt:

$$\text{dBm} = 10 \times \log_{10} (\text{reading}^2 / \text{reference resistance} / 1 \text{ mW})$$

The reference resistance value (**Ref R**) may be 50, 75, 93, 110, 124, 125, 135, 150, 250, 300, 500, 600 (default), 800, 900, 1000, 1200, or 8000 Ω . Press **Ref R** and use the front panel up and down arrows to make your selection.

See Also

[Math - Introduction](#)

[Null](#)

[Statistics](#)

[Limits](#)

Math - Scaling

NOTE

This topic describes dB/dBm Scaling for the 34465A/70A. Scaling features are different for the 34460A/61A and are described in the [dB dBm Scaling Menu](#) topic.

Press the **Scaling** softkey to open the default dB scaling menu:



Press the **Function** softkey to select a scaling function:

NOTE

Scaling is set to OFF when you change measurement functions (for example, changing from DCV to ACV). You must re-enable scaling after changing measurement functions.

dB Scaling

Each dB measurement is the difference between the input signal and a stored reference value, with both values converted to dBm:

$$\text{dB} = \text{reading in dBm} - \text{reference value in dBm}$$

The relative value must be from -200 to +200 dBm (default 0). You can either measure this value by pressing **Measure Ref Value**, or you can use the **dB Ref Value** softkey to specify a value.

dB scaling applies to ACV and DCV measurements only.

dBm Scaling



The dBm function is logarithmic, comparing power delivered to a reference resistance, relative to 1 milliwatt:

$$\text{dBm} = 10 \times \log_{10} (\text{reading}^2 / \text{reference resistance} / 1 \text{ mW})$$

The reference resistance value (**Ref R**) may be 50, 75, 93, 110, 124, 125, 135, 150, 250, 300, 500, 600 (default), 800, 900, 1000, 1200, or 8000 Ω. Press **Ref R** and use the front panel up and down arrows to make your selection.

dBm scaling applies to ACV and DCV measurements only.

% Scaling



% performs a percent change operation. The result is the percent change of the measurement from the reference value:

$$\text{Result} = ((\text{Measurement} - \text{Reference}) / \text{Reference}) * 100.$$

Press **Measure Reference** to use the first measurement as the reference value, or press **Ref Value** to specify the reference value.

% scaling applies to all measurement functions except Ratio, Continuity, and Diode.

Mx-B Scaling



For Mx-B scaling, the result is the measurement multiplied by the **Gain (M)** value minus the **Offset (B)** value.

The **User Units** softkey allows you to specify the custom alphanumeric label of up to four characters (for example, RPM or °C) for Mx-B scaled measurements.

Mx-B scaling applies to all measurement functions except Ratio, Continuity, and Diode.

See Also

[Math - Introduction](#)

[Null](#)

[Statistics](#)

[Limits](#)

Math - Smoothing

(34465A/70A only) Smoothing uses a moving average (boxcar) filter to reduce random noise in measurements. Smoothing is intended to average out small variations in the measurements. Larger variations will cause the filter to reset.



Press **Response** to select **Slow** (100 readings), **Medium** (50 readings), or **Fast** (10 readings) to average.



The smoothing filter applies to all measurement functions except Digitizing, Data Logging, Continuity, Diode, and Probe Hold.

The smoothing filter starts out from a reset condition (no readings in the filter) and is reset if the measurement function is changed or if a reading is too far beyond the current average. After the filter is reset, the reading is the average of all readings up to the specified response (10, 50, 100). At that point, the reading is the moving average of the last 10 (Fast), 50 (Medium), or 100 (Slow) readings. Equal weighting is applied to all readings in the average.

The **Filter** icon (top, right-side of the display) indicates the variation of readings, the amount of allowable readings in the filter, and when the filter is reset as follows:

- Too great of reading variation will constantly reset the filter and the filter icon will be solid yellow (**Filter**).
- As the filter fills with readings, that are within the allowable variation from the readings already in the filter, the filter icon will turn green progressively from left to right (**Filter** -> **Filter**).
- A single reading, that is beyond the allowable variation from the readings in the filter, will reset the filter and set the filter icon to solid yellow (**Filter**).
- If all readings are within the allowable variation from the readings in the filter, the filter icon will be solid green (**Filter**).

Math - Statistics

As the instrument takes measurements, it automatically calculates statistics on those measurements.

Front Panel Menus

The statistics menu is accessed from the third softkey in the **[Math]** menu.



NOTE For accurate displayed statistics of AC measurements in Front Panel mode, the default manual trigger delay (**[Acquire] > Delay Man**) must be used.

The first softkey on this menu (shown below) hides or shows the statistics below the data display (number, bar meter, trend chart (not available on the 34460A), or histogram).

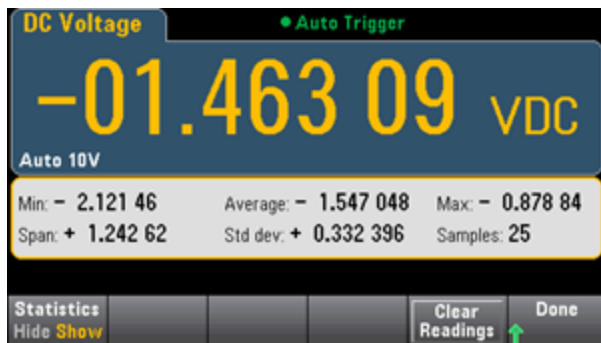

The average and standard deviation are not shown if dB or dBm scaling is in use.

Remarks

- The **Span** value is the **Max** minus the **Min**.
- Press **Clear Readings** to clear reading memory and re-start statistics calculation.

See Also

[Math - Introduction](#)

[Null](#)

[dB/dBm Scaling](#)

[Limits](#)

Math - Limits

Limit checking indicates how many samples have exceeded specified limits and visually indicates when the limits are exceeded.

Front Panel Menus

The limits menu is accessed from the **[Math]** menu.



The first softkey enables or disables limits. The second and third softkeys specify the limits either as high and low values or as a span around a center value. For example, a **Low** limit of -4 V and a **High** limit of +7 V are equivalent to a **Center** of 1.5 V and a **Span** of 11 V.

The **Beeper** softkey enables or disables beeping when limits are violated (this also enables or disables the beeper for the other functions that use the beeper - probe hold, diode, continuity, and errors). **Clear Condition** resets the limit borders to green, as described below.

Limit Indications

The display uses colors to indicate limits and limit violations.

Trend Chart (34461A/65A/70A only)

The limit area is shown in light red on the graph. The limit borders are green (shown below) as long as the limits have not been exceeded.

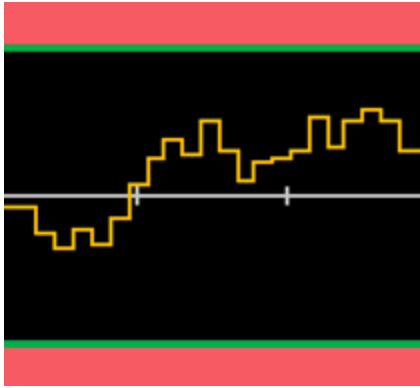

When a limit is exceeded, the border turns red. In the image below, the top border is still green, but the bottom border has changed to red because the trend line has gone into the lower limit area.

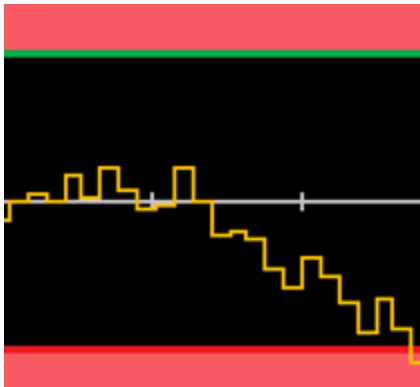

The border will remain red even if the trend line moves out of the limit area. When the trend line is within limits, you can reset the borders to green by pressing **Clear Condition**.

Note also that the number of the newest displayed measurement, +09.994 VDC below, indicates whether the measurement is within limits. Because the limit is 10 V, the 9.994 VDC value is shown with the standard background.

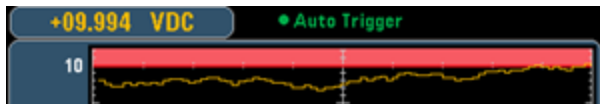

In contrast, the 11.083 VDC reading is highlighted in red to indicate that it is outside the limits.

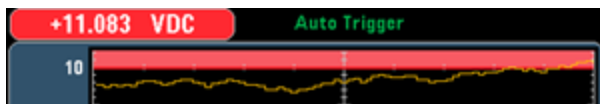

Features and Functions

Histogram

The same color scheme applies to histograms. In the image below, the green vertical lines that separate the black histogram background from the light red limit areas indicate that limits have not been exceeded.

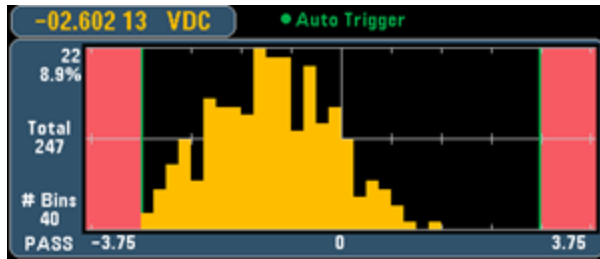

In the image below, the lower (left) limit border is red, indicating that the lower limit has been exceeded. (The reading in the upper left corner (-01.68487 VDC) is within limits, so it is not red.)

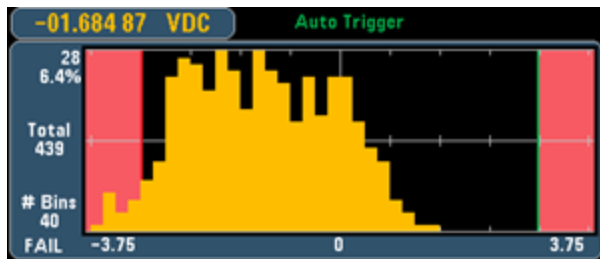

Bar Meter

The bar meter (below) uses the same color scheme. The green limit border on the left indicates that the lower limit has not been exceeded, and the red limit border on the right indicates that the upper limit has been exceeded. The numbers 0 and 259 below the light red limit areas indicate how many times each limit has been exceeded, and the word FAIL indicates that a limit has been exceeded.

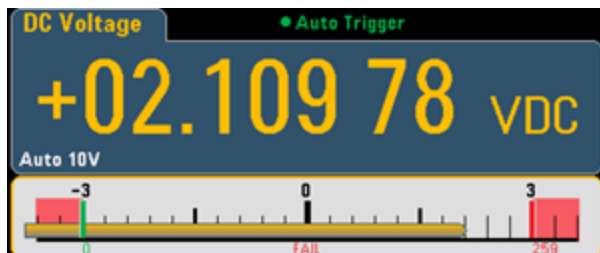

Number

The bright red color (shown below) indicates that the displayed measurement exceeds the limits. The **Number** display also indicates how many times the limits have been exceeded.

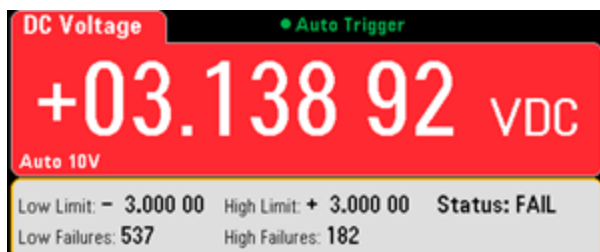

See Also

[Math - Introduction](#)

[Null](#)

[dB/dBm Scaling](#)

[Statistics](#)

Display - Introduction

By default, the instrument displays readings as a number. You can also select a Bar Meter, Trend Chart (34461A/65A/70A only), or Histogram display:



For the Number and Bar Meter displays, many primary measurement functions allow you to display a secondary measurement. See [Secondary Measurements](#) for details.

Selecting the Display

Pressing the  key, followed by the **Display** softkey allows you to select the display type:



The following table summarizes the various instrument display types for each measurement mode.

Mode	Display Type				Comments/Uses
	Number	Bar Meter	Trend Chart	Histogram	
Continuous	Power-on default, present measurement on display.	Number + bar graph, present measurement on display.	Measurements spanning a specified amount of time, and displayed as strip chart (Trend), or histogram. Exact measurement values not accessible from front panel.		Trend and Histogram data is display only, individual reading values not available from front panel.
Data Log	Present reading on display. All other points stored as specified in Acquire menus. Remaining time and remaining samples displayed near bottom.		Chart or Graph populated as samples taken. Zoom, pan and cursors available to facilitate individual measurement viewing.		Standard on the 34465A and 34470A only. See Data Log Mode for details.
Digitize	Present reading on display. All other points stored as specified in Acquire menus. Remaining time and remaining samples displayed near bottom.		Chart or Graph populated as samples taken. Zoom, pan and cursors available to facilitate individual measurement viewing.		34465A and 34470A only, requires DIG option. Optimized for high speed sampling. Max sample interval 100 ms, min 20 μ s. See Digitize Mode for details.

Click a link below for more information on any of the display types:

[Number](#)

[Bar Meter](#)

[Trend Chart \(34461A/65A/70A only\)](#)

[Histogram](#)

[Secondary Measurements](#)

Number

By default, the instrument displays readings as a number:

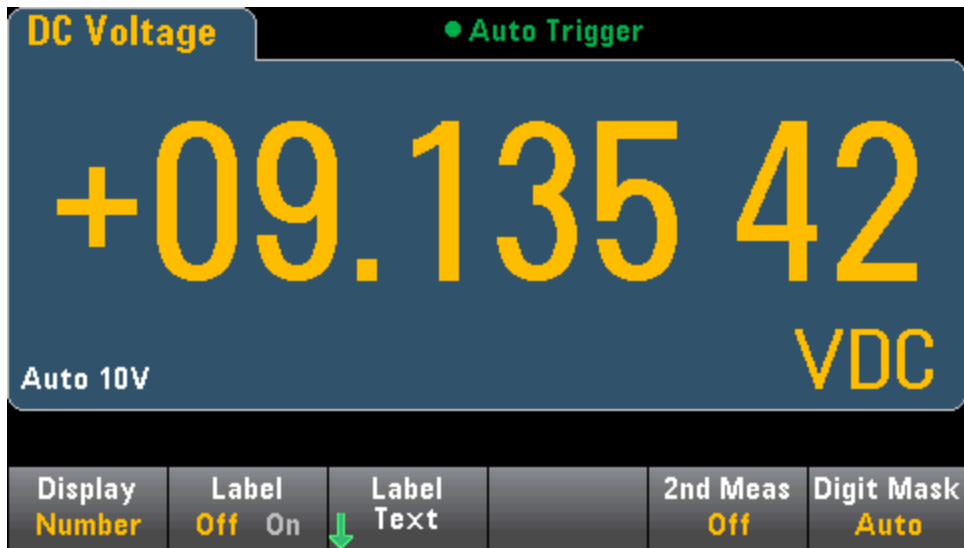

Adding a Label

The **Label** softkey allows you to add a large text label on the screen. For example, you can use this to indicate what measurement is being taken by the DMM.

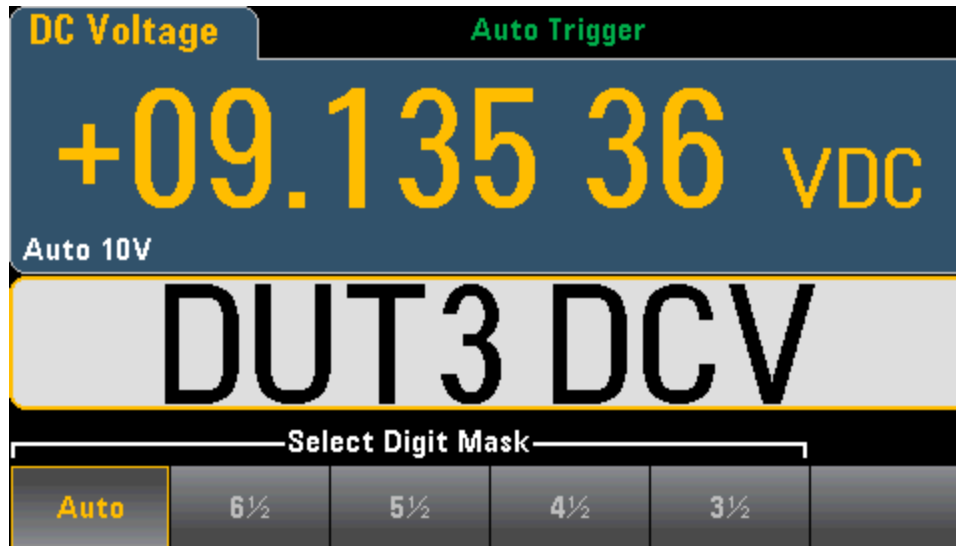

To enter the text, press **Label Text** and use the softkeys and front panel arrow keys to modify the label (below). Then press **Done**. The label's font automatically shrinks to accommodate longer labels.



Selecting a Secondary Measurement

Press **2nd Meas** to select and display a secondary measurement. For example, for the DCV measurement function, you can select ACV, Peak, or Pre-Math as the secondary measurement function. With ACV selected as secondary, the display shows the DCV measurement near to top of the display, and the ACV measurement near the bottom of the display:



Refer to [Secondary Measurements](#) for more information on secondary measurements available for each measurement function.

Specifying the Digit Masking

The Digit Mask softkey specifies the number of digits shown.



For example, the following image shows 6½ digits.

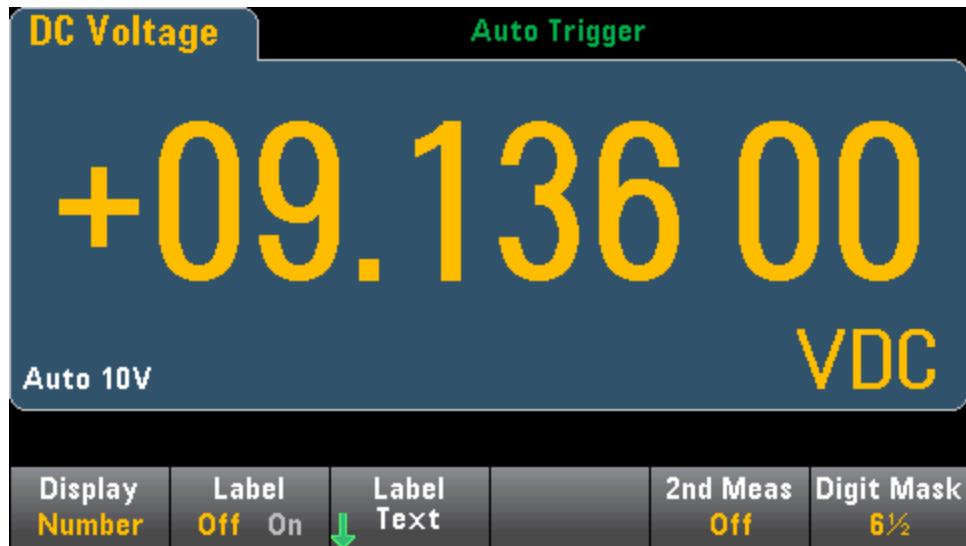

In contrast, this image shows 4½ digits.



The **Auto** softkey specifies that the number of digits displayed is based on other function-specific settings, such as the measurement aperture, set in NPLCs. Measurements are always rounded, never truncated.

Features and Functions

See Also

[Display - Introduction](#)

[Bar Meter](#)

[Trend Chart \(34461A/65A/70A only\)](#)

[Histogram](#)

[Secondary Measurements](#)

Bar Meter

The bar meter (below) adds a moving bar below the standard Number display.

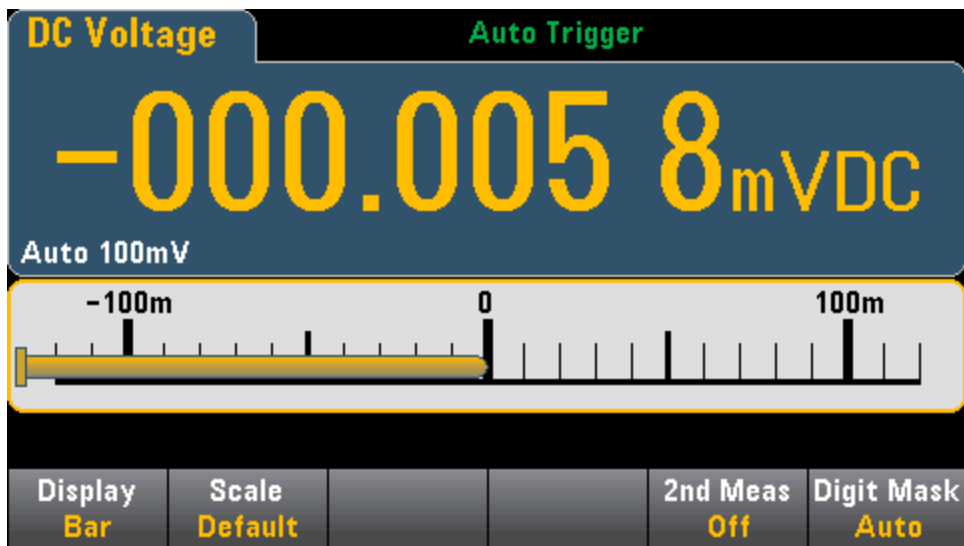

The **Display** and **Digit Mask** softkeys behave as they do in the [Number](#) display.

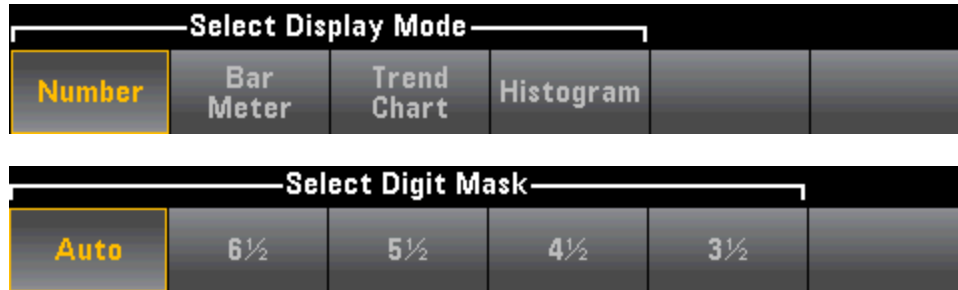

The **Scale** softkey specifies the horizontal scale:



- **Default** sets the scale to equal the measurement range.
- **Manual** allows you to configure the scale either as **High** and **Low** values or as a **Span** around a **Center** value. For example, a scale that goes from a **Low** of -500 Ω to a **High** of 1000 Ω could also be specified as a **Center** of 250 Ω with a **Span** of 1500 Ω.



Selecting a Secondary Measurement

Press **2nd Meas** to select and display a secondary measurement. For example, for the DCV measurement function, you can select ACV, Peak, or Pre-Math as the secondary measurement function. With ACV selected as secondary, the display shows the DCV measurement as a number near top of the display, DCV in the bar meter, and the ACV measurement above the bar meter:

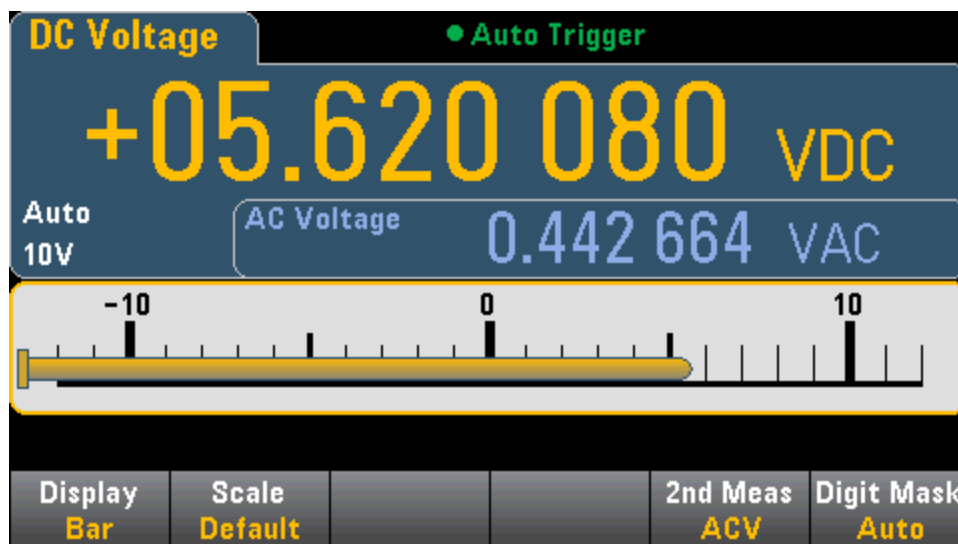

Refer to [Secondary Measurements](#) for more information on secondary measurements available for each measurement function.

See Also

[Display - Introduction](#)

[Number](#)

[Trend Chart \(34461A/65A/70A only\)](#)

[Histogram](#)

[Secondary Measurements](#)

Trend Chart (Continuous Measurement Mode)

This topic describes trend chart behavior for the 34461A/65A/70A only, in Continuous measurement mode. The trend chart is not available for the 34460A.

To select the trend chart, press **[Display]** followed by the **Display** softkey:



In the Continuous measurement mode, the trend chart shows data trends over time:

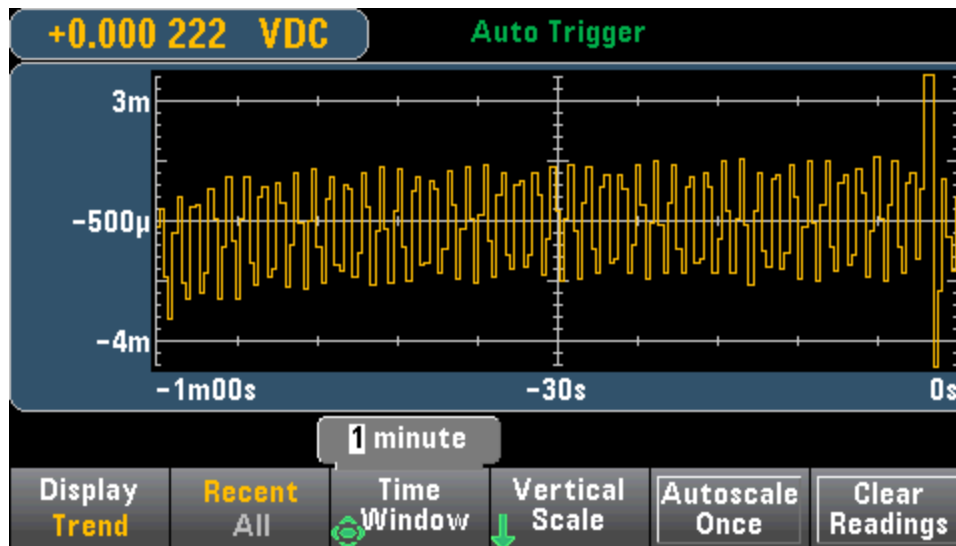

Data is collected and displayed in pixel columns as described below.

Recent/All

The **Recent/All** softkey shows either all of the data in the trend chart (**All**) or just the most recent data (**Recent**). Neither selection clears reading memory.

In All mode, the trend chart displays all readings being taken and builds from left to right. After the display is filled, the data becomes compressed on the left side of the display as new data is added on the right side of the display.

In Recent mode, the trend chart displays data taken during a specified amount of time. For the 34465A/70A, this time is selected with the **Time Window** softkey (1 minute to 1 hour). For the 34461A, this time is fixed at 1 minute, and there is no **Time Window** softkey. Changing this setting clears the trend chart but does not clear reading memory, statistics or histogram data.

Pixel Columns

The trend chart display area is 400 pixels wide by 147 pixels high. A pixel column is 1 pixel wide by 147 pixels high. Each pixel column on the trend chart display represents 1/400 of the Time Window value; the Time Window setting determines the amount of time represented by each pixel column as follows:

- 1 Minute = 150 mS per pixel column - this time is used for the 34461A's Recent mode, and the All mode (34461A/65A/70A)
- 5 Minutes = 750 mS per pixel column (34465A/70A only)
- 10 Minutes = 1.5 S per pixel column (34465A/70A only)
- 30 Minutes = 4.5 S per pixel column (34465A/70A only)
- 1 Hour = 9 S per pixel column (34465A/70A only)

When the reading rate is faster than the time per each pixel column, the column will represent multiple readings. In this situation, the trend chart draws a vertical line in each pixel column showing the maximum to minimum measurement values acquired during that time period:

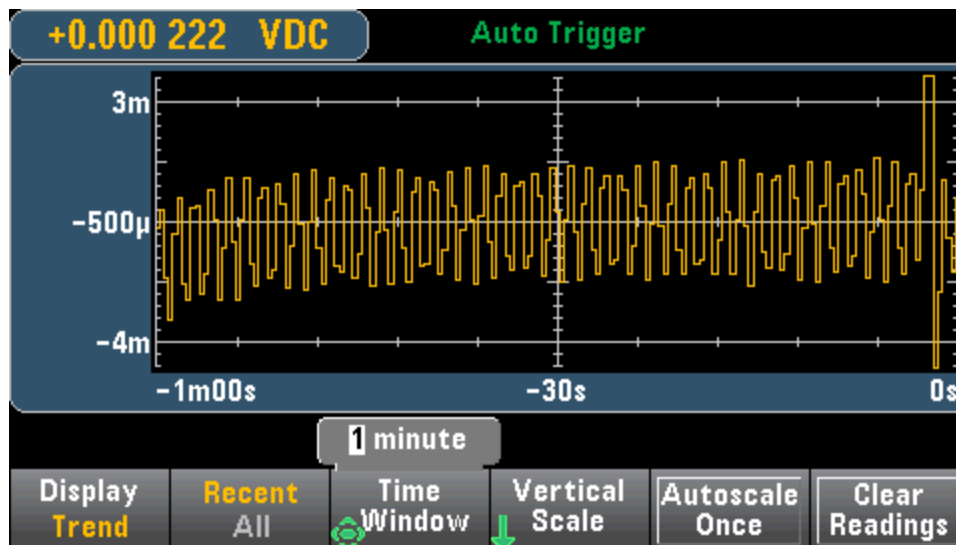

When the reading rate is slower than the time per pixel column, some pixel columns may represent no readings. In this situation, the trend chart continues with a horizontal line across the pixel:

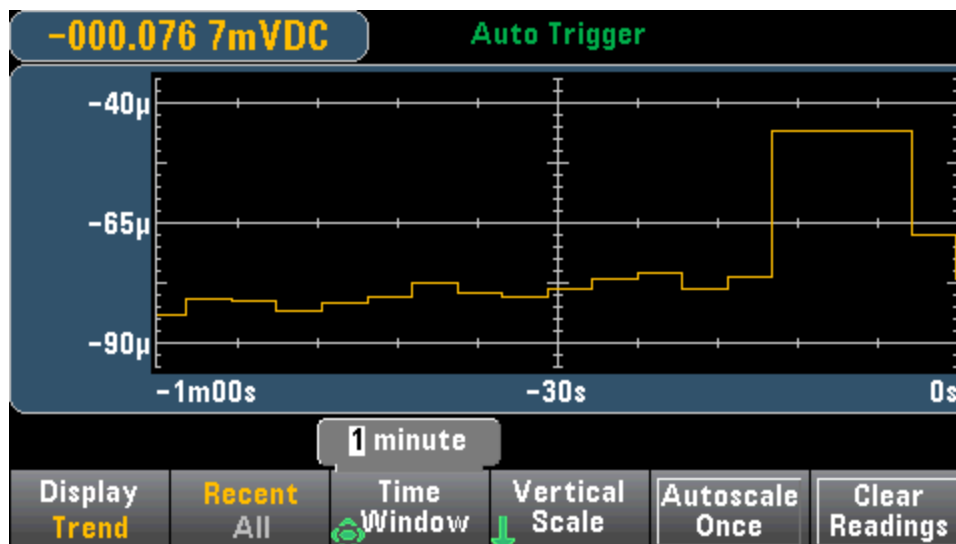

Scaling

The **Vertical Scale** softkey specifies how the current vertical scale is determined.



Press **Vertical**, to change the scaling:



- **Default** sets the scale to equal the measurement range.
- **Auto** automatically adjusts the scale to appropriately fit the line currently shown on the screen.
- **Manual** allows you to configure the scale either as **High** and **Low** values or as a **Span** around a **Center** value. For example, a scale from a **Low** of 0 V to a **High** of 5 V is equivalent to a **Center** of 2.5 V and a **Span** of 5 V.



If you have enabled limits, the **(Limits)** softkey also appears. This sets the vertical scale to match the limits.



See Also

[Display - Introduction](#)

[Number](#)

[Bar Meter](#)

[Histogram](#)

Trend Chart (Digitize and Data Log Modes)

This topic applies only to 34465A/70 DMMs.

Trend Chart - Digitize Mode

When the 34465A/70A DMM is in digitize mode (DIG option required), Zoom, Pan, and Cursor trend chart controls are available. To enter digitize mode, press **[Acquire]** > **Acquire** softkey > **Digitize**.

To select the trend chart, press **[Display]** followed by the **Display** softkey:



In the digitize mode, these trend chart softkeys are available:

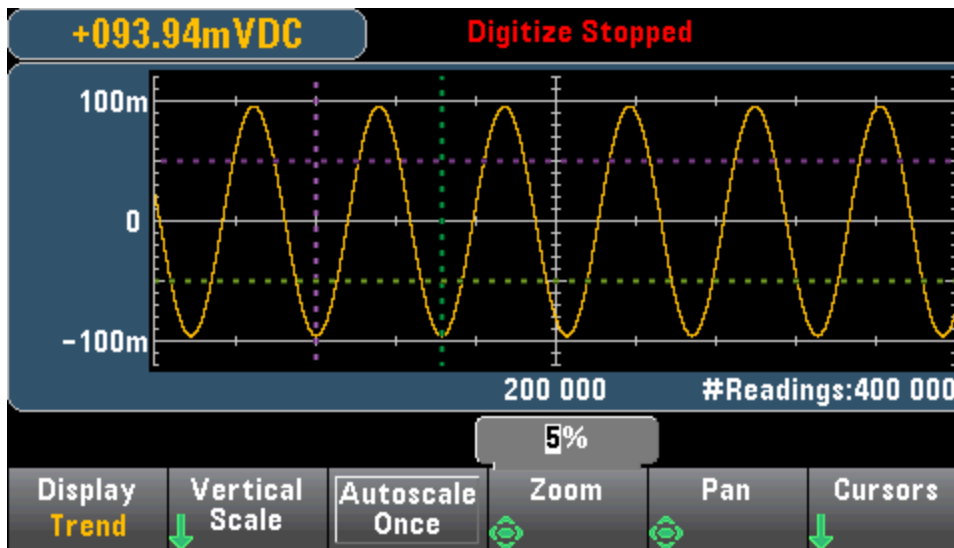

Zoom - Sets the horizontal axis zoom percentage. Press **Zoom** and use the up/down arrow keys to select the amount of zoom, in percent. 100% is the maximum amount of zoom with a maximum of one reading shown per display pixel column. The display is 400 pixels wide. You can select a zoom percentage of 1%, 2%, 5%, 10%, 20%, 50%, or 100%. For example, the graphic above shows 5% zoom and the graphic below shows the same signal at 100% zoom:

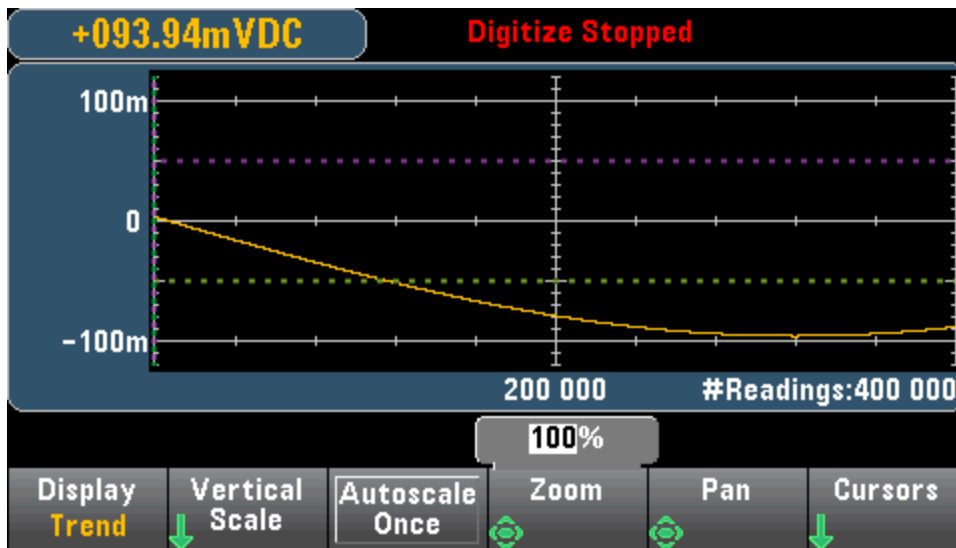

Pan - Selects which reading in memory is displayed at the center of the screen. Use the up or right arrow key to increase the reading number displayed - this causes the graph data to move to the left. Use the down or left arrow key to decrease the reading number displayed - this causes the graph data to move to the right.

Press and release an arrow key to move the cursor one display pixel. Hold down an arrow key to move the cursor in 20 pixel increments. The number of readings represented per pixel depends on the zoom percentage.

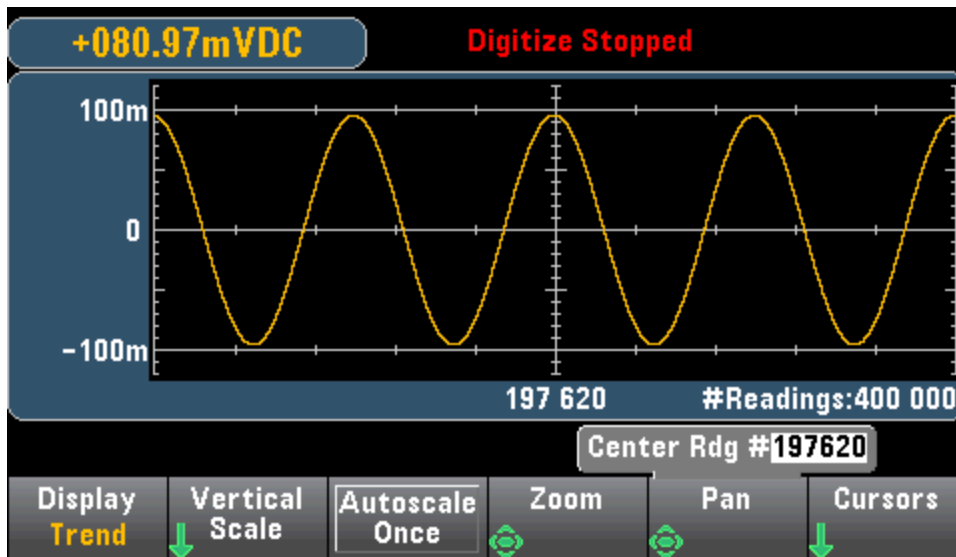

Tip: Zoom to 100% to pan one reading at a time. After selecting a reading, you can then decrease the zoom, if necessary, to view the surrounding signal.

Cursors - Display and control X1, X2, Y1, Y2, and tracking cursors (shown as lines) on the trend chart.

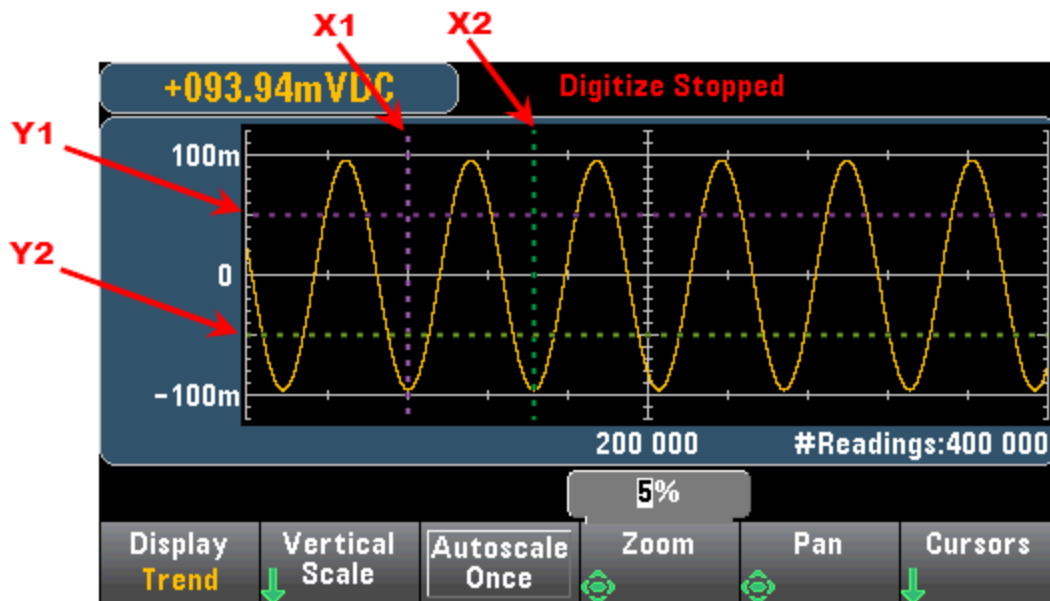

X cursors are vertical lines along the sample or time axis. Use the up or right arrow key to move the cursor to the right; the down or left arrow key to move the cursor to the left. Press and release an arrow key to move the cursor one display pixel. Hold down an arrow key to move the cursor in 10 pixel increments. Y cursors are horizontal lines along the measurement (magnitude) axis in units of the selected measurement (DCV or DCI). Use the left and or right arrow keys to select a digit of magnitude displayed above the Y1 or Y2 softkey. You can then use the up or down arrows keys to increment/decrement the digit and move the cursor up or down by that amount. Cursor X1 and Y1 are violet; cursor X2 and Y2 are green.

Press **Cursors** > **Cursors** to display the choices:



X Only – Displays only the X1 and X2 cursors. In this mode, these softkeys are available:

- **X1** - Use the arrow keys to control the X1 cursor.
- **X2** - Use the arrow keys to control the X2 cursor.
- **ΔX Lock** - When **ON**, keeps the X cursors a fixed distance apart as either cursor is moved.

Y Only – Displays only the Y1 and Y2 cursors. In this mode, these softkeys are available:

- **Y1** - Use the arrow keys to control the Y1 cursor.
- **Y2** - Use the arrow keys to control the Y2 cursor.
- **ΔY Lock** - When **ON**, keeps the Y cursors a fixed distance apart as either cursor is moved.
- **Place Yn on Screen** - Press **Y1** or **Y2** followed by this softkey to set the cursor to a value that puts it into view on the chart.

X and Y – Displays the X1, X2, Y1 and Y2 cursors. In this mode, these softkeys are available:

Features and Functions

- **X1** - Use the arrow keys to control the X1 cursor.
- **X2** - Use the arrow keys to control the X2 cursor.
- **Y1** - Use the arrow keys to control the Y1 cursor.
- **Y2** - Use the arrow keys to control the Y2 cursor.

Track Rdnng at X - Select two readings, by reading number, using X1 and X2 softkeys to display X (time) and Y (magnitude) values for each reading, and the delta X and delta Y values.

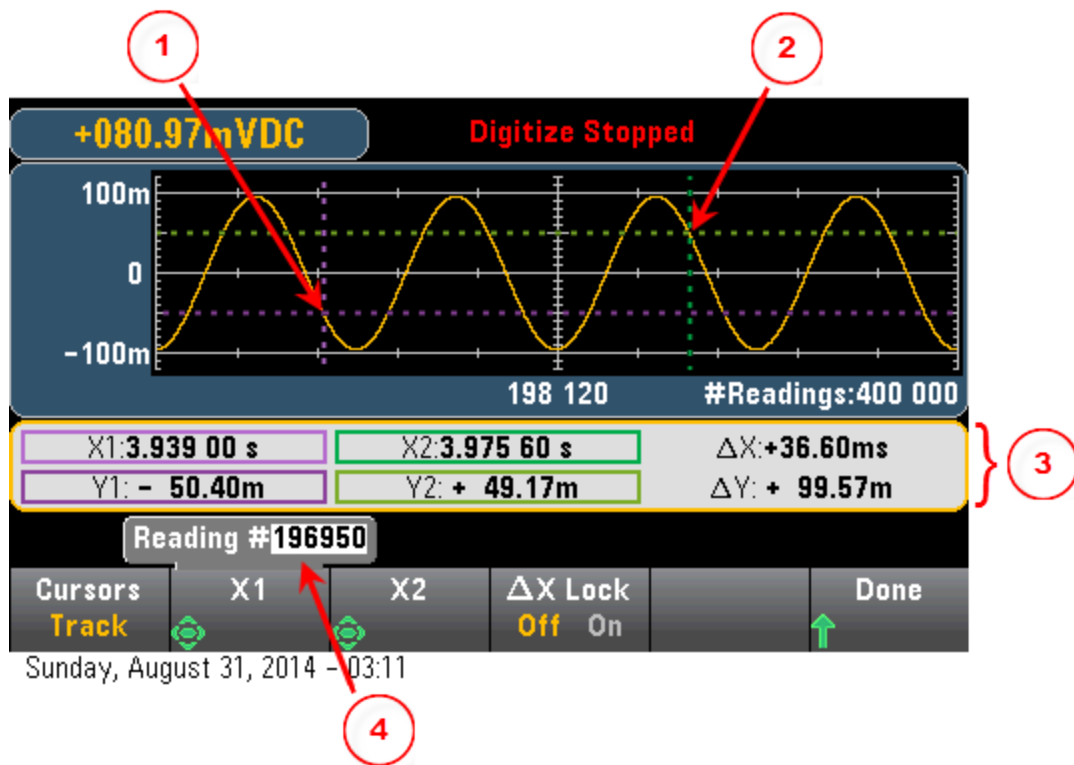

In the graphic above:

- 1 Y1 cursor tracks X1 cursor position.
- 2 Y2 cursor tracks X2 cursor position.
- 3 Cursor time and amplitude information, ΔX , ΔY .
- 4 Press X1 or X2 to display reading number.

These softkeys are available for **Track Rdnng at X** mode:

- **X1** - Use the arrow keys to control the X1 cursor.
- **X2** - Use the arrow keys to control the X2 cursor.
- **ΔX Lock** - When **ON**, keeps the X cursors a fixed distance apart as either cursor is moved.

Tip: To record the X and Y data and the delta X and Y data as a screen shot, take a screen shot of the Web UI, not the front panel screen shot utility.

Trend Chart - Data Log Mode

This topic applies only to the 34465A/70 DMMs, data logging is standard for these DMMs. See [Data Logging](#) for more information on how to configure data logging.

When the DMM is in data log mode, Zoom, Pan, and Cursor trend chart controls are available. To enter data log mode, press [**Acquire**] > **Acquire** softkey > **Data Log**.

To select the trend chart, press [**Display**] followed by the **Display** softkey:



In the data log mode, trend chart behavior depends on whether you are data logging to instrument memory, or data logging to a file(s).

Data Logging to Memory

When data logging to memory, the trend chart maps each reading to a dot in a pixel column, draws a line between multiple dots in each column, and draws a line from the last reading in a column to the first reading in the next column.

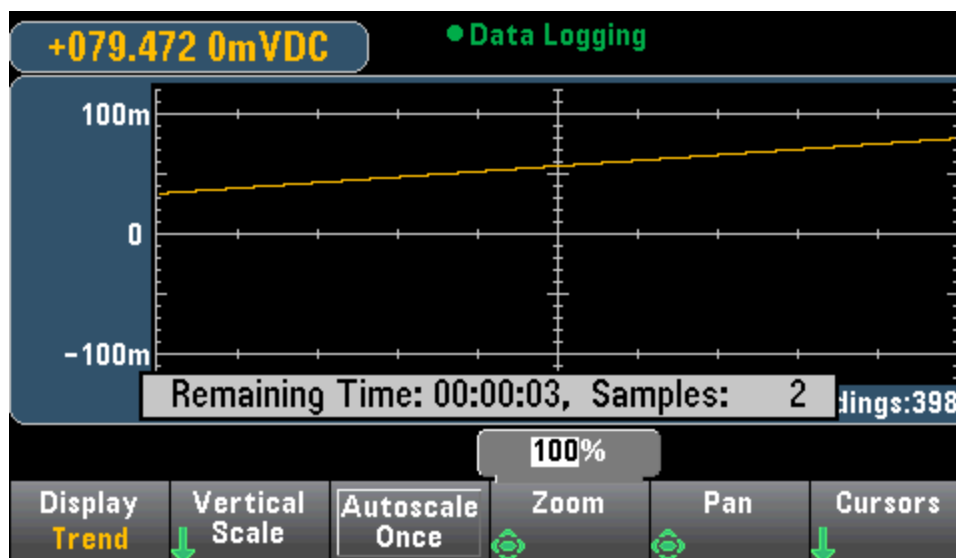

When data logging to memory, Zoom, Pan, and Cursors are available and operate as described above in the digitize section.

Data Logging to File(s)

When data logging to files, the trend chart behaves in a manner similar to that of the continuous measurement mode. That is, the number of readings shown per pixel column depends on the reading rate and the selected Time Window.

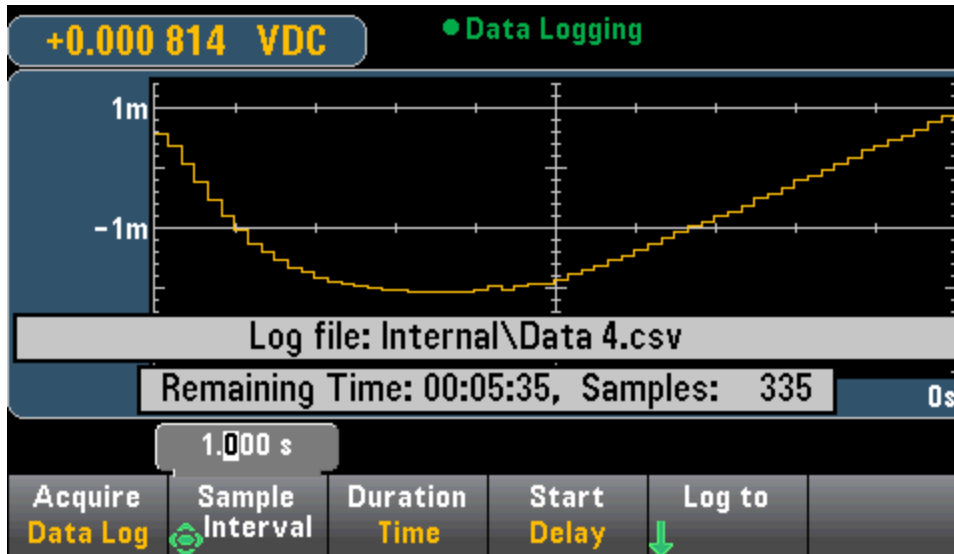

Zoom, Pan, and Cursors are not available when data logging to files. Refer to [Trend Chart \(Continuous Measurement Mode\)](#) for more information.

See Also

[Display - Introduction](#)

[Trend Chart \(Continuous Measurement Mode\)](#)

[Number](#)

[Bar Meter](#)

[Histogram](#)

Histogram

The histogram shows measurement data as a graphical representation of the distribution of measurement data. Data is grouped in bins represented by vertical bars in the histogram display.

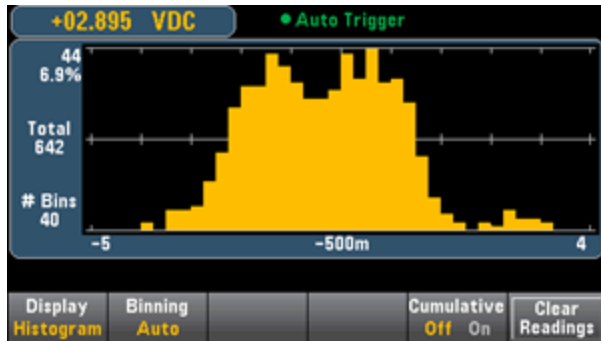

NOTE Autoranging can adversely affect the histogram display when measuring repetitive signals spanning multiple ranges. To avoid this, select a fixed range when using the histogram display.

Selecting the Display

Pressing the  key, followed by the **Display** softkey allows you to select the display type:



Binning

The **Binning** softkey allows you to either let the instrument control how the histogram is binned (auto-binning), or to manually specify the binning parameters with the **Bin Settings** softkey. Changing any binning parameter, or switching between automatic and manual binning, will automatically start the histogram over with new data. On the 34461A/65A/70A, this also resets the trend chart.



For **Binning Auto**, the algorithm starts by continuously readjusting the histogram span based on the readings coming in, completely re-binning the data whenever a new value comes in outside of the current span. After acquiring a large number of readings, a new reading outside of the range causes the bins to be compressed by a factor of two such that the new bin range will cover the new reading. The number of bins shown is a function of the number of readings received: 0 to 100 readings = 10 bins, 101 to 500 readings = 20 bins, 501 to 1000 readings = 40 bins, 1001 to 5000 readings = 100 bins, 5001 to 10000 readings = 200 bins, >10000 readings = 400 bins. If the NPLC setting is < 1 PLC, or Aperture Time (34465A/70A only) is < 20 mS, the maximum number of bins is 100.

Features and Functions

For **Binning Manual**, you can set number of bins to 10, 20, 40, 100, 200, or 400. You can specify the bin range as either **Low** and **High** values, or as a **Span** around a **Center** value. For example, the histogram range shown above (from -5 to 4 V) could be specified as a **Low** of -5 V and a **High** of 4 V, or a **Center** of -0.5 V and a **Span** of 9 V.

The **Outer Bins** softkey displays two additional bins, for readings above and below the bin range. For example, this image shows the **Outer Bins** softkey set to **Off**.

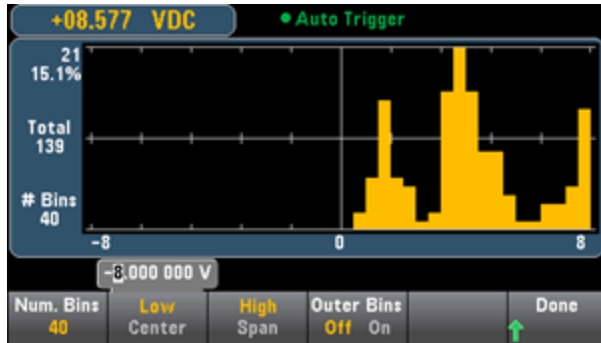

The image below adds the outer bins to the display. The relatively large number of readings above the bin range (the cyan bar) causes the bars within the bin range to shrink.

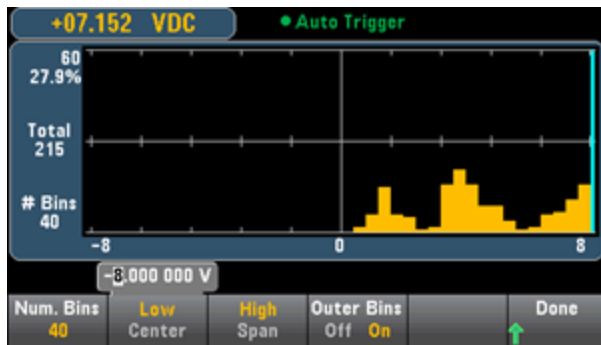

The main histogram menu includes a **Cumulative** softkey that hides or shows a line representing the cumulative distribution of the histogram data. Note that this line represents *all* of the data only when the outer bins are shown; if the outer bins are not shown, the outer bin data is not represented in the line. The cumulative distribution line always goes from 0 to 100% on the vertical scale, regardless of the histogram's scale.

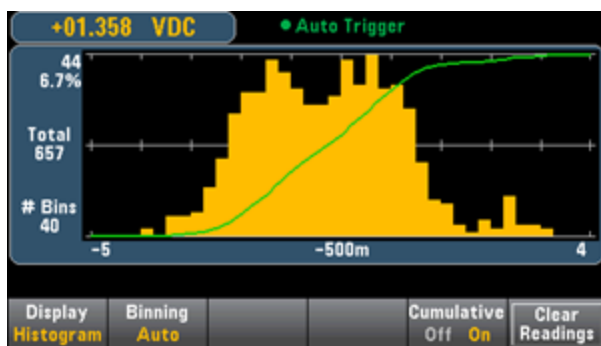

The final button on the histogram menu, **Clear Readings**, clears reading memory and starts a new histogram.

Histogram Data

The graphic below shows a histogram of frequency measurements. Data is displayed on the left side of the histogram. In the graphic below, reading from top left downward:

- **3.011 06 kHz** - present measurement value.
- **48** - Number of samples in the largest bin.
- **19.0%** - Percentage of samples in the largest bin.
- **Total 253** - Total number of samples.
- **# Bins 20** - Total number of bins.
- **0, 2.5k, 5k** - (Below the histogram) Range of frequency values.

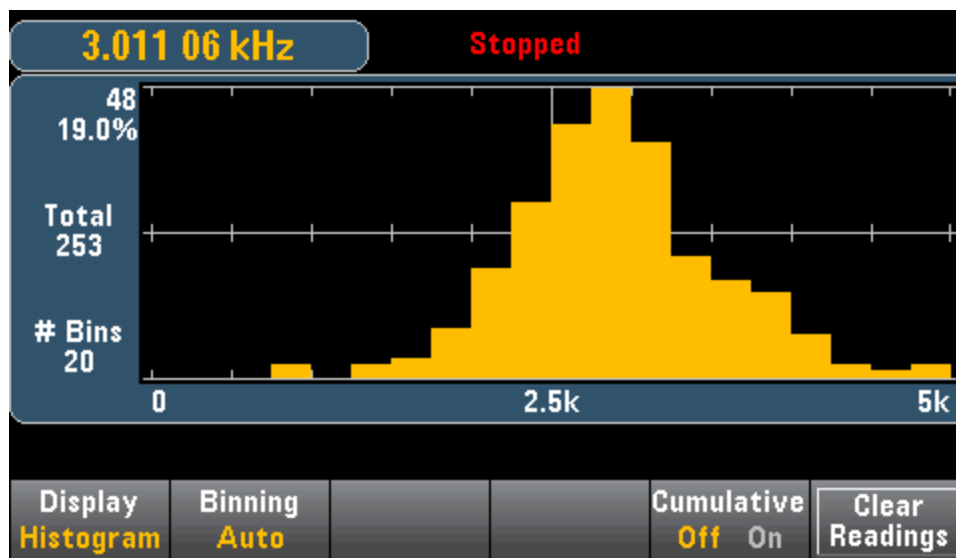

Cursors (34465A/70A only)

Press the **Cursors** softkey (34465A/70A only) to display the histogram cursors.



Cursors in the histogram are specified as bin numbers and display the range of values covered by those bins, the count and the percentage of the total. The total count and percentage of total, as well as the measurement range covered, between the cursor bins, is also displayed. In the graphic below, cursor B1 (violet vertical lines) is positioned on bin number 10 and cursor B2 (green vertical lines) is positioned on bin number 14 (bin number shown above the **B1** softkey). The bin information for cursor B1 is shown in the violet box, the bin information for B2 in the green box. For example, the information in the B1 box is in the graphic below is:

- **2.250 00 k to 2.500 00k** - Range of frequency measurement values for this bin.
- **#29** - Number of samples in this bin.
- **11.5%** - Percentage of the total number of samples in this bin.

The data between the B1 and B2 cursors, including the data in the B1 and B2 bins, is shown to the right of the violet and green boxes. In the graphic below:

- **Span:** - The measurement range covered from B1 to B2.
- **#178** - The number of samples from B1 to B2.
- **70.4%** - The percentage of the total number of samples from B1 to B2.

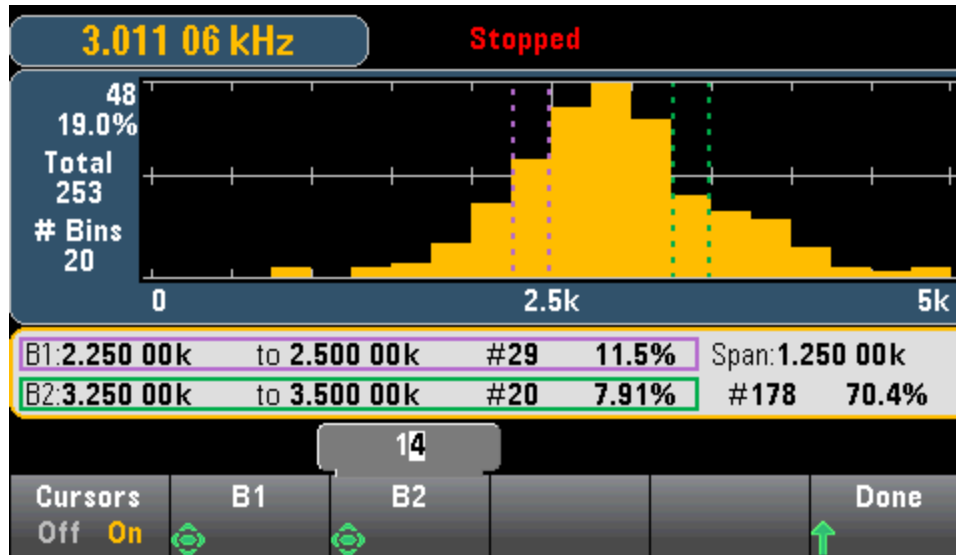

When Outer Bins are shown (when using manual binning) a zero cursor value indicates the outlier count below the histogram range, and one plus the number of bins indicates the outlier count above the histogram range.

Histogram with Statistics

Showing statistics (**Shift > Math > Statistics**) is particularly useful for the histogram display. For example, in the graphic below, the thick blue line is the average, each thin blue line represents one standard deviation from the average.

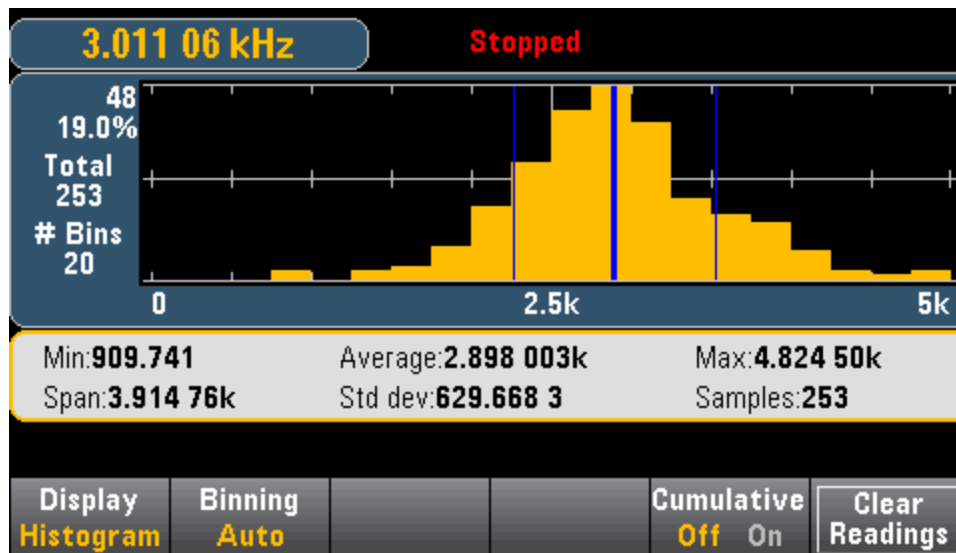

See Also

[Display - Introduction](#)

[Number](#)

[Bar Meter](#)

[Trend Chart \(34461A/65A/70A only\)](#)

Utility Menu - Introduction

The **[Utility]** key is the shifted **[Display]** key:



[Utility] provides the following features:



[Store and Recall State and Preference Files](#)

[Manage files, including creating screen shots](#)

[Configure LAN \(optional on 34460A\), GPIB \(optional on all models\), and USB](#)

[Perform instrument self-tests and administrative functions](#)

[Configure the instrument's date and time and various user settings](#)

Utility - Autocalibration

Autocalibration compensates for drift caused by time and temperature change in DC voltage and resistance measurements, and adjusts some aspects of other measurement functions.

To quickly perform autocalibration without editing the cal string message, press **Shift > ACAL (Up Arrow)** key.

Use the procedure below to use menus and softkeys to edit the cal string message and perform autocal

Step 1: Press **Utility** on the front panel.

Step 2: Press the **Test/Admin** softkey:



Step 3: Press the **Calibrate** softkey:



Step 4: (Optional step) Press the **Edit Cal String** softkey and enter the information for the cal string message. Common messages include the last calibration date, calibration due date, or calibration department contact information. When finished, press the **Done** softkey

Step 5: Press the **Perform Autocal** softkey:

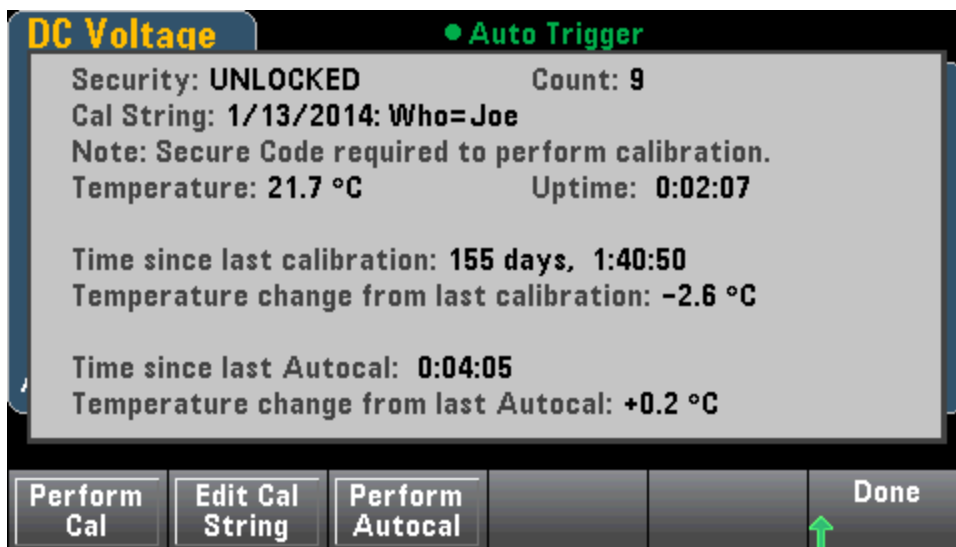

Utility - Store and Recall State and Preference Files

The Utility menu is shown below.



Press **Store/Recall** to save and recall state and preference files. In general, state files store volatile settings associated with measurements. Preferences are non-volatile parameters associated with the instrument, but not any specific measurement. For details, see the table in the [MMEMory State and Preferences Subsystem](#).



Store Settings

Store Settings allows you to browse to a directory and specify a file name, and to choose whether you want to store a state file or a preference file.



Press **Type** to select whether you want to store a state or preferences file, and press **Store State** (shown above) or **Store Pref** (the softkey's label if you are storing preferences) to store the specified file.

Action allows you to either store a file or to create a new folder.

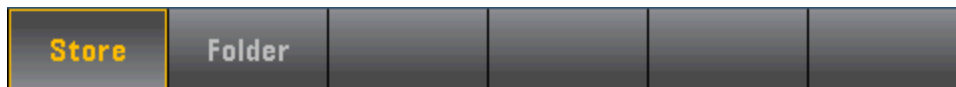

Recall Settings

Recall Settings allows you to browse to the file to be recalled. Use the arrow keys to navigate to the desired state file (*.sta) or preferences file (*.prf).



Power On

Power On selects the state that is loaded at power-up. This can be either the state when the instrument was powered down with the power switch (**Last**), a user-selected state file (**User Defined**), or the factory default state (**Factory Defaults**).



Set to Defaults

Set to Defaults loads the instrument's factory default state or preference settings.

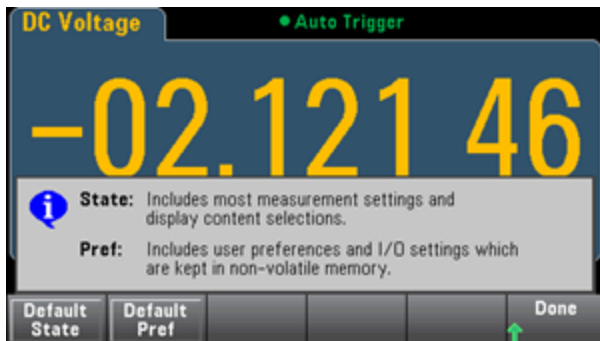

Utility Menu - Manage Files



The **Manage Files** softkey allows you to create, copy, delete, and rename files and folders in the instrument's internal flash memory or on a USB drive attached to the front panel. It also allows you to capture the current screen to either a bitmap (*.bmp) or portable network graphics (*.png) file. This is the default option, as shown below.



Action

Action specifies the action to perform. Pressing **Capture Display** saves a screen capture of the display at the moment that you pressed **[Shift]** to go to the **[Utility]** menu.



Delete - To delete a file or folder, press **Delete** and **Browse** to the folder or file to delete. Press **Select** > **Perform Delete** > **Done**.

Folder - To create a folder, **Browse** to the internal or external location for the folder, press **File Name**, enter a folder name and press **Done**. Press **Create Folder** > **Done**.

Copy - To copy a file or folder, press **Copy**. **Browse** to the folder or file to be copied and press **Select**. Press **Copy Path** and select an internal or external path for copying. Press **Perform Copy** > **Done**.

Rename - To rename a file or folder, press **Rename**. **Browse** to the folder or file to be renamed and press **Select**. Press **New Name**, enter a new name and press **Done**. Press **Perform Rename** > **Done**.

Browse

Browse selects the file or folder upon which the action will be performed.

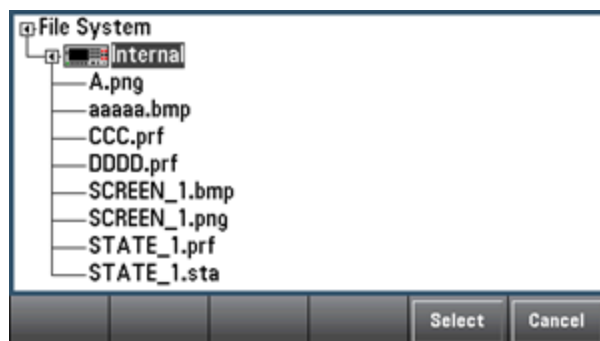

Use the front panel arrows and **[Select]** key to navigate through the list, and press **Select** or **Cancel** to exit the browse window. The left and right arrows contract or expand a folder to hide or show its files.

File Name

File Name allows you to use the front panel arrows, the **[Select]** key, and the softkeys to enter a file name. Use the front panel arrows to point to a letter, and **Previous Char** and **Next Char** to move the cursor in the area where the name is entered. In the image below, there is no **Next Char** softkey because the cursor is at the end.

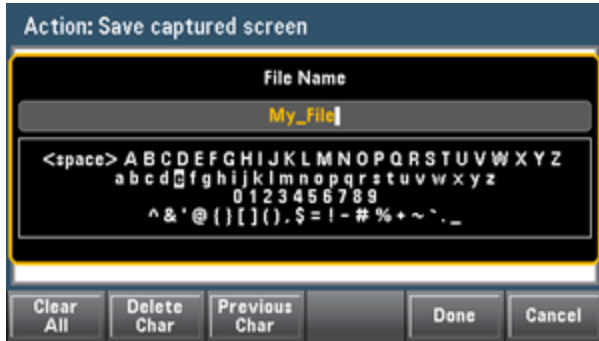

Press **[Done]** or **[Cancel]** to finish.

Utility Menu - I/O Configuration



I/O Config configures the I/O parameters for remote operations over the LAN (optional on 34460A), USB, or GPIB (optional) interface.



LAN enables and disables the instrument's LAN interface, and **LAN Reset** resets the LAN using its current settings and enables DHCP and mDNS. The **LAN Reset** softkey also clears any user-defined Web Interface password.

LAN Settings

LAN Settings opens the menu shown below. **Set to Defaults** resets the LAN settings to their default values.



Modify Settings

Modify Settings enables DHCP or Manual (Auto-IP) assignment of the instrument's IP address. It also enables configuration of network parameters based on the protocol (DHCP or Manual) selected.



For example, press **Host Name** or **Service mDNS** to modify the instrument's host name or mDNS Service Name, shown below.



LAN Services

LAN Services enables and disables the LAN services shown below.



After enabling/disabling one or more services, press **Done** > **Apply Changes**. After that, you must cycle instrument power for the new settings to take effect.

The Web server enables or disables instrument programming from the instrument’s Web interface.

The multicast DNS (mDNS) service is for use in networks where no conventional DNS server is installed. Cycling power or resetting the LAN always enables mDNS.

The instrument Telnet port is 5024. Open SCPI sessions on the Telnet connection by entering:

```
telnet IP address 5024
```

Refer to the Keysight IO Libraries help for information on the VXI-11, Sockets, and HiSLIP protocols.

USB Settings

USB Settings configures the front panel USB (storage) and rear-panel USB (connectivity) connectors.



NOTE The SEC licensed option also gives you the ability to enable or disable the front panel USB interface via a **USB Front** softkey. This option can be ordered as factory option or as customer-installable option. See [Models and Options](#) for details. Without this option, the front panel USB interface is always enabled.

USB SCPI

USB SCPI enables or disables the rear-panel USB control port. After changing the interface state, cycle instrument power to make the change take effect. When disabled, the interface cannot be configured by the Keysight IO Libraries Connection Expert utility.

Easy File Access (File Access Softkey)

Easy File Access uses media transfer protocol (MTP) to easily download instrument files to your PC. Simply connect the rear-panel USB port on the instrument to a USB port on your PC. The DMM will appear as a read-only drive on your PC's file system.

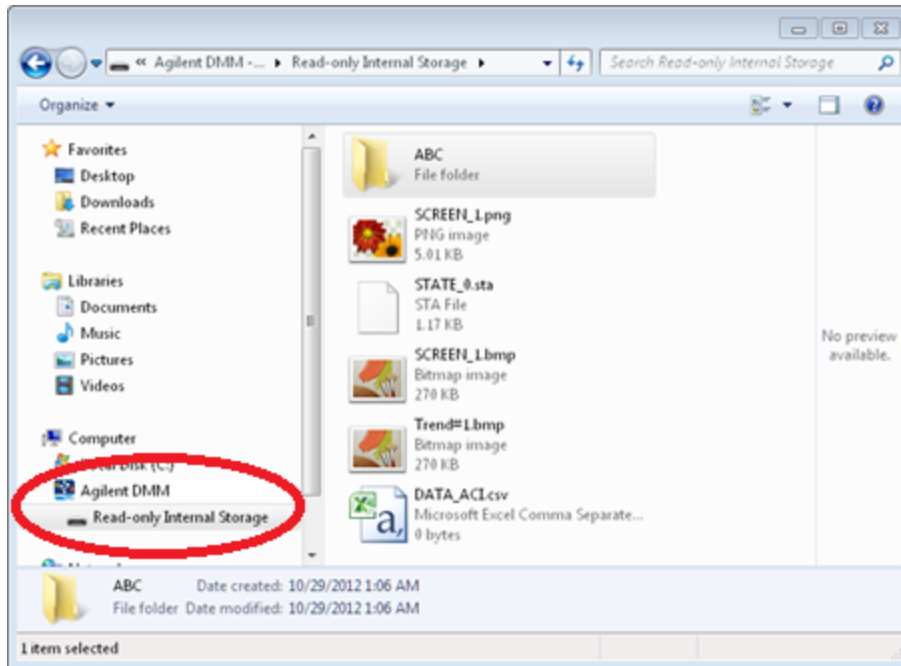

You can use your PC's standard file management features to copy files from the DMM to your PC.

NOTE To use **Easy File Access** at the same time that you are remotely programming the instrument with SCPI over the USB interface (**USB SCPI**), you must have Keysight IO Libraries Suite 16.3 or later installed on your PC. You may download the latest version at www.keysight.com/find/iosuite.

To use **Easy File Access** on a PC running the Windows XP operating system, make sure you have Microsoft Windows Media Player 11 for Windows XP SP1, or are using a Microsoft Windows XP SP2, SP3, or a newer version of Windows. You may download this software at www.microsoft.com/en-us/-download/details.aspx?id=8163.

GPIB Settings (optional)

GPIB Settings enables or disables your instrument's GPIB interface.

When disabled, the interface cannot be configured by the Keysight IO Libraries Connection Expert utility.

You can also set GPIB address to a value from 0 to 30. After enabling or disabling GPIB or changing the address, cycle instrument power for the change to take effect.



Utility Menu - Test/Admin



Test/Admin provides access to self-test, calibration, and administrative functions:



Self-Test

Self-Test verifies proper instrument operation. See [Self-Test Procedures](#) for details, and always safely disconnect inputs to the DMM terminals before running the Full Test.

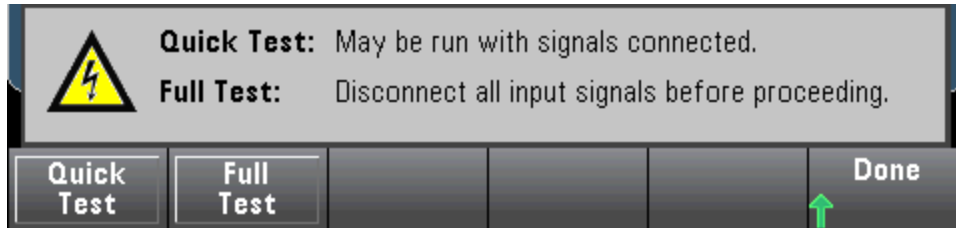

Calibrate

Calibrate accesses the instrument calibration procedure. See [Calibration](#) for details.

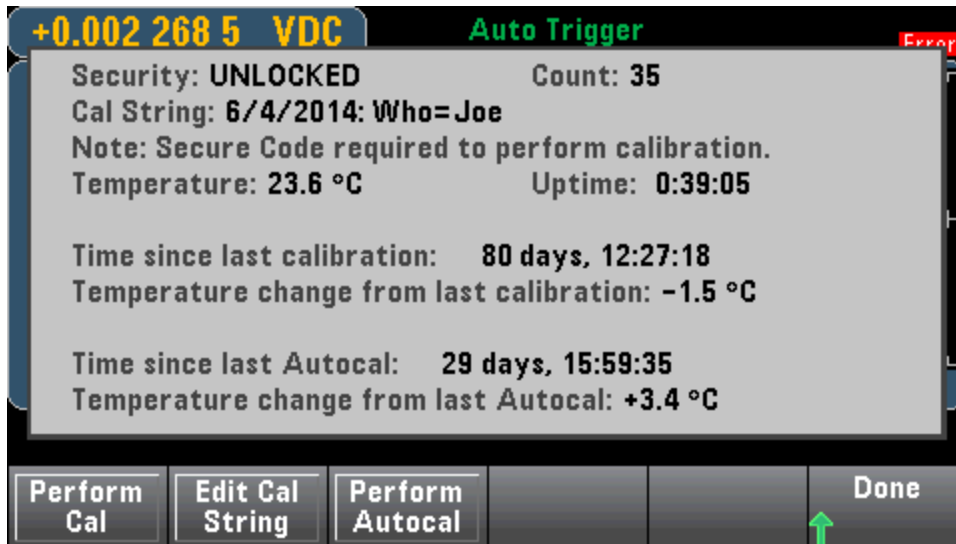

Security

Security manages the secure code and security features. If you have the SEC option, you must enter the Secure Code to configure some features.

NISPOM Sanitize sanitizes all user-accessible instrument memory except for the calibration constants and reboots the instrument. This complies with requirements in chapter 8 of the National Industrial Security Program Operating Manual (NISPOM).

CAUTION

The **NISPOM Sanitize** softkey and the `SYSTEM:SECurity:IMMEdiate` command are equivalent. They are for customers, such as military contractors, who must comply with NISPOM.

This feature destroys all user-defined state information, measurement data, and user-defined I/O settings such as the IP address. This feature is not recommended for use in routine applications because of the possibility of unintended data loss.

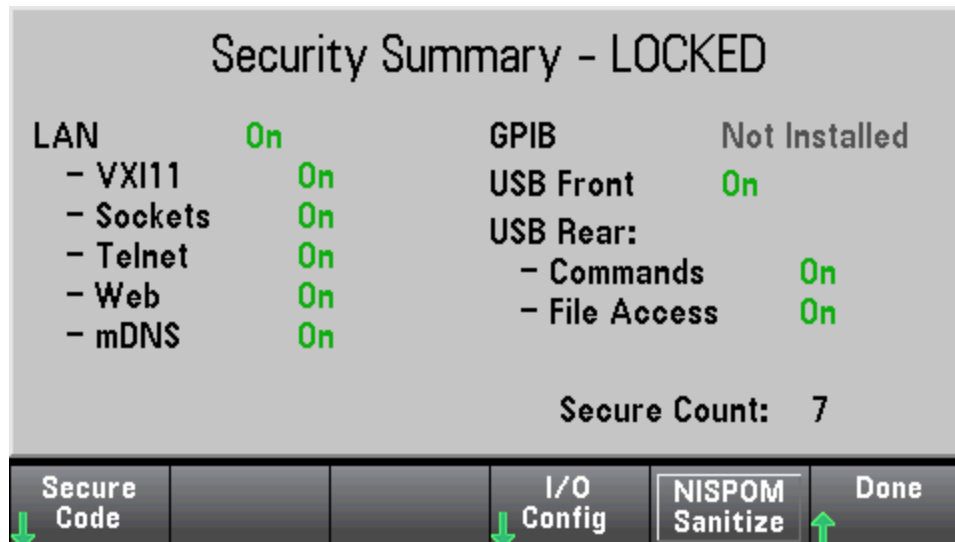

Install License

Install License enables licensed instrument features. For information on obtaining licenses, go to www.keysight.com/find/truevolt.

After receiving a license file from Keysight, use the following procedure to install the license:

1. Save the license file to a USB drive and connect the USB drive to the DMM's front panel USB connector.
2. Press **[Shift] > [Utility] > Test/Admin > Install License**.
3. Use the front panel arrow keys to navigate to the license file location and press **Select**.
4. Upon successful license installation, the DMM displays **License Installation Successful**.

Firmware Update

Firmware Update updates the instrument firmware to a new version. See [Firmware Update](#) for details.

Utility Menu - System Setup



System Setup configures user preferences, sets the date and time, and sets a power-on message.



User Settings

User Settings specifies user preferences that control how you interact with the instrument. These settings are stored in non-volatile memory and can be saved in a preferences (.prf) file.



Help Language

Help Lang selects the help language for front panel use: English, French, German, Japanese, Korean, Russian, or Simplified Chinese. All messages, context-sensitive help, and help topics appear in the selected language. The softkey labels are always in English.

Number Format

Number Format specifies how numbers are displayed on the front panel: 12,345.6 or 12.345,6. Other possibilities also exist. For example, you can use the space as a separator.



Sounds



Disables or enables the click heard when a front panel key or softkey is pressed.

Also enables or disables the audible tone (**Beeper On** or **Off**) associated with the following features:

- Limits – a measurement limit is exceeded (if limits are enabled)
- Probe Hold – the measured signal records a stable reading
- Diode – the forward bias voltage is between 0.3 and 0.8 V
- Continuity – a short is measured (less than or equal to 10 Ω)
- Error - an error is generated from the front panel or remote interface

This non-volatile setting appears in several different menus on the front panel. Turning the beeper on or off in one menu affects all of the other menus and functions. For example, turning the beeper off for probe hold, also turns the beeper off for limits, diode, continuity, and errors.

Display Options

Display Options configures the display.



You can enable or disable the display, adjust the brightness (10 to 100%), enable or disable the screen saver, and pick a color scheme. If you turn off the display, press any front panel key to turn it on again.

By default, the screen saver turns off and blanks the screen after eight hours of inactivity. You may disable this screen saver from the front panel only.

The display is enabled when power is cycled, after an instrument reset (***RST**), or when you return to local (front panel) operation. Press the **[Local]** key or execute the IEEE-488 GTL (Go To Local) command from the remote interface to return to the local state.

SCPI ID

SCPI ID determines the instrument's response to a ***IDN?** query. Choices for each DMM model are:

- **34460A** - 34460A, AT34460A, HP34401A
- **34461A** - 34461A, AT34461A, HP34401A
- **34465A** - 34465A, AT34410A, AT34411A
- **34470A** - 34470A, AT34410A, AT34411A

Choices above with no prefix (34460A, for example) return Keysight Technologies as the manufacturer. Choices above with an AT or HP prefix, return Agilent Technologies or Hewlett Packard, respectively, as the manufacturer. These choices are included for ***IDN?** compatibility with existing programs that expect ***IDN?** to return a particular manufacturer and model number.

If you have an older Agilent 34460A or 34461A and upgrade to the new (Keysight) firmware, your instrument continues to respond with the manufacturer name “Agilent”, not “Keysight” until you set the front panel SCPI ID to 34460A or 34461A, send the **SYST:IDEN DEF** command, or reset user preferences. After doing this, the instrument responds with “Keysight” as the manufacturer.

Important: In order to update the instrument firmware *from remote*, the model number in the ***IDN?** response must match the actual instrument model number. If you have changed the instrument's ***IDN?** response to another instrument, when attempting to update the firmware from remote, you will see this error: *The instrument is not supported by this firmware file.* To update the firmware, either update using the front panel procedure or, from remote, use **SYSTem:IDENtify** to set the ***IDN?** to match the actual model number, update the firmware, and then use **SYSTem:IDENtify** again to set the ***IDN?** response to the other model number.

Date / Time

Date / Time sets the instrument's real-time clock, which always uses a 24-hour format (00:00:00 to 23:59:59). There is no automatic setting of the date and time, such as to adjust for daylight savings time. Use the front panel arrow keys to set the year, month, day, hour, and minute.

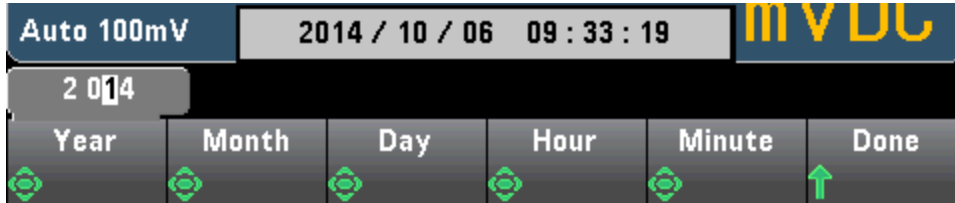

Power on Message

Power on Message sets a message that is displayed when the instrument powers up and when you press [Help] > About.



Use the front panel arrows and **[Select]** key to select the letters. Then press **Done** to exit and save the message. The message will appear as shown below when you turn the instrument on or press [Help] > About.



Web Interface

The Keysight Truevolt Series DMMs include a built-in Web Interface for monitoring and controlling the instrument via a Web browser. To begin, connect your instrument to the LAN and enter the instrument's IP address into the address bar at the top of your PC's Web browser, or select the instrument in Connection Expert and click the **Instrument Web Interface...** button. The Web Interface will appear in the browser as shown below (34465A DMM shown).

NOTE

The following is a high-level overview of the four Web Interface tabs shown on the left side of



the Web Interface window. When using the Web Interface, click the help button for detailed information on any page, for example:



Welcome Page

The Welcome Page displays basic instrument information. To change any of the information displayed on this page, use the [Configuration Page](#).

Instrument Documentation and Technical Support | Keysight Home

KEYSIGHT TECHNOLOGIES 34465A 6-1/2 Digit Multimeter

Welcome to your

Web-Enabled 34465A
[Instrument Documentation and Technical Support](#)

Information about this Web-Enabled 34465A:

Instrument:	34465A
Serial Number:	PROTO00027
Description:	Keysight 34465A Digital Multimeter - PROTO00027
DNS Hostname:	DavesUnit
NetBIOS Name:	DavesUnit
mDNS Hostname:	DavesUnit.local
IP Address:	156.140.92.2
Instrument Address String:	TCPIP::DavesUnit::hislip0::INSTR TCPIP::DavesUnit::inst0::INSTR

[Turn On Front Panel Identification Indicator](#)

[Advanced information about this Web-Enabled 34465A](#)

Use the navigation bar on the left to access your 34465A and related information.

© Keysight Technologies 2014



Instrument Monitor and Control Page

This page allows you to monitor and control the DMM. This page opens in the *Observe Only* mode and automatically opens the Monitor DMM window (described below). In *Observe Only* mode, the instrument control settings are grayed out (disabled). This mode allows you to keep track of DMM operations remotely. The **About** section shows installed licenses, the instrument firmware revision, and the instrument serial number.

In *Allow Full Control* mode, this window configures the instrument and takes measurements. Simply select the DMM settings and click **Apply**.

The six buttons along the top of the screen are described below.

Monitor DMM

When the main page is set to *Observe Only* mode, this window opens showing a textual display of DMM readings, secondary measurements (if enabled), and statistics. In *Allow Full Control* mode, the **Clear All** and, if applicable, **Clear Peaks** buttons become active:

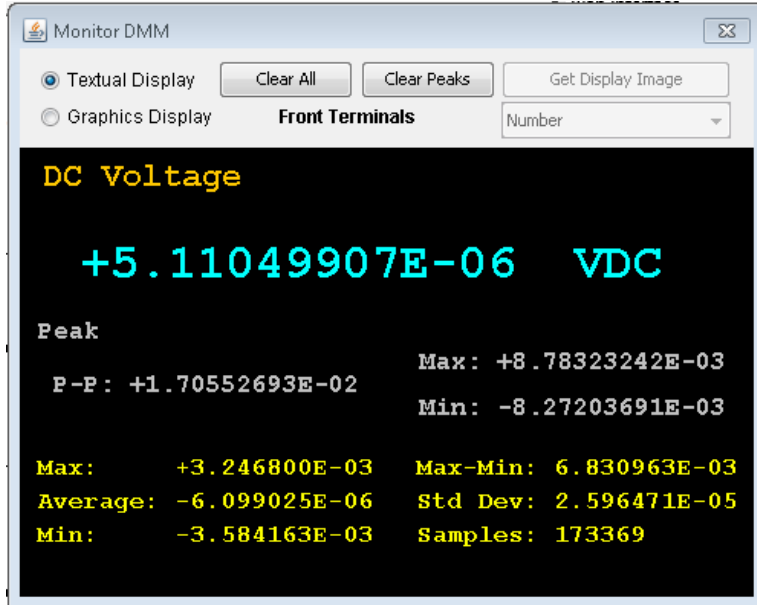

In *Allow Full Control* mode, to view data as shown on the instrument's graphical display (trend chart, histogram, and so on), click the **Graphics Display** radio button and click **Get Display Image** to update the graphical display:

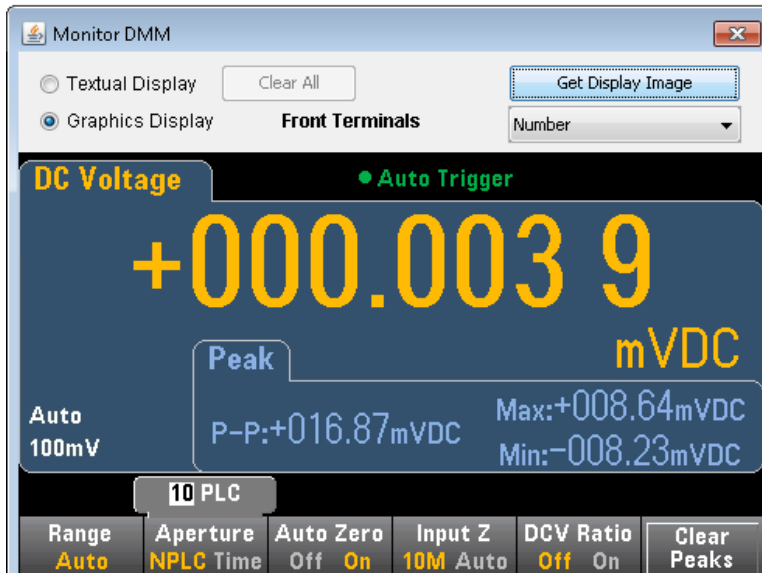

View Data

For both the *Observe Only* and *Allow Full Control* modes, this window keeps a running display of **Readings in Memory** and has these active controls:

- **Readings** - Enter a **Start Index** (reading number) and **Number of Readings to Get** and click **Get Data** to display those readings at the bottom of the window. Readings are not cleared from instrument memory. Use the checkboxes to enable/disable the displayed **Index** or **Units**. Use the mouse to highlight any displayed data and press **Ctrl-C** to copy to the Windows Clipboard. Click **Clear Data Window** to erase the readings in the display.
- **Last Value** - Click **Last Value > Get Data** to display the last reading taken by the DMM.
- **Statistics Data** - Click **Statistics Data > Get Data** to display Maximum, Average, Minimum, Max-Min, Standard Deviation, and Samples (number of readings).
- **Histogram Data** - Click **Histogram Data > Get Data** to display Reading Count, Auto Bin (On or OFF), Number of Bins, Upper Range, Lower Range, and Bin Data.

For the *Allow Full Control* mode, this window has these additional controls:

- **Read and Remove Readings** - The **Start Index** is fixed at 1. Enter the number of **Readings to Remove** and click **Get Data** to display those readings at the bottom of the window. The readings displayed ARE cleared from instrument memory.
- **Delete All Readings** - Deletes all readings in the instrument reading memory and does not display any readings.

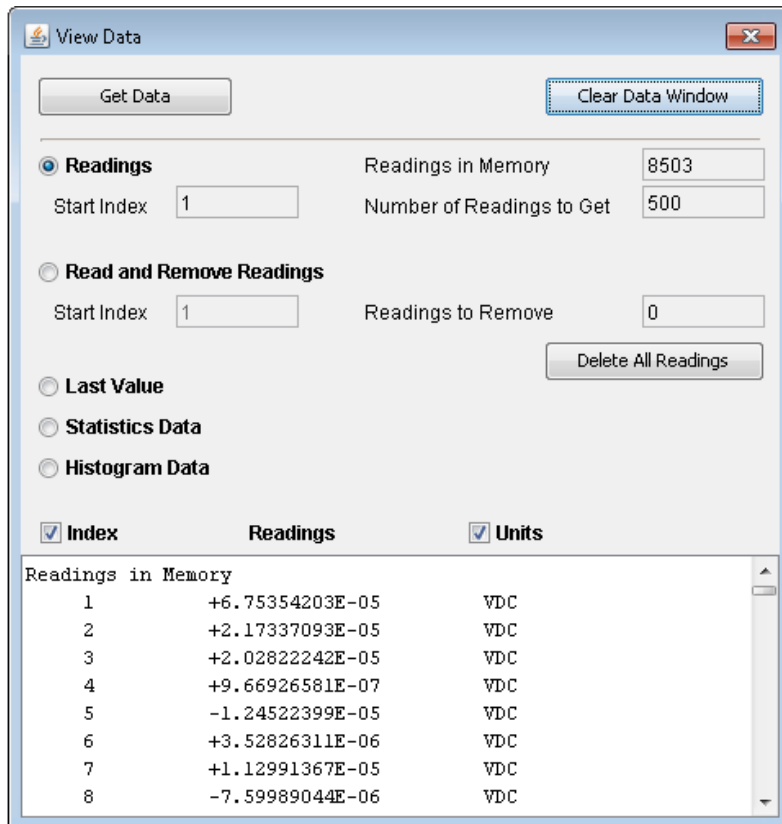

DMM Overview

This window generates reports with information such as the instrument's firmware, configuration, calibration, SCPI configuration, and error queue. Check the desired boxes on the left side of the screen and

then click **Generate Report**. The **Change in SCPI Configuration** box produces a list of all of the SCPI commands required to change the instrument state since the last time a report was generated. This provides a convenient way for you to learn SCPI syntax.

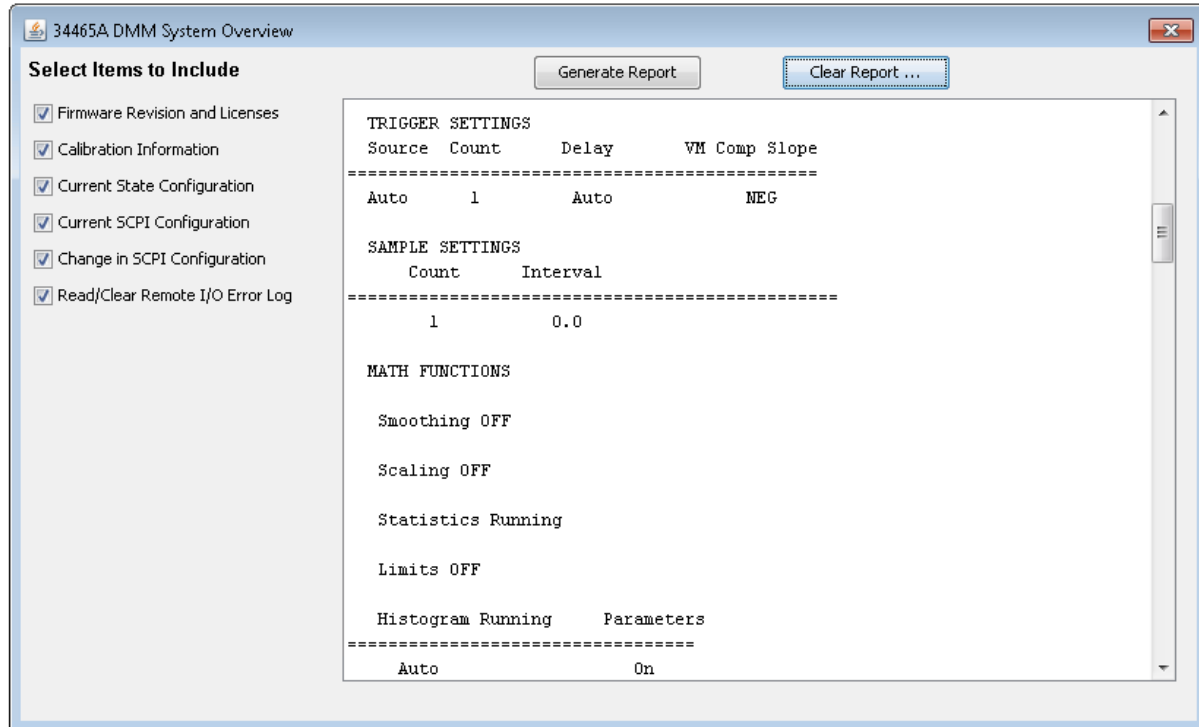

Store/Recall

In the *Allow Full Control* mode, this window saves, recalls, and deletes instrument states.

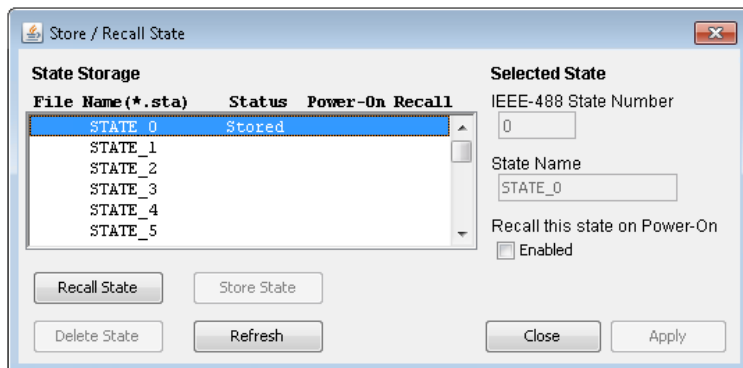

Commands

In the *Allow Full Control* mode, this window lets you interactively send commands to the DMM and read responses. You can use this to become familiar with the instrument's command set, and to rapidly prototype commands and check responses before writing code. Buttons on the right side of the window send a Device Clear, *RST, or send and read *IDN? or SYST:ERR?.

Use the **Enter SCPI command or query** field to enter SCPI commands and click **Send**, to execute the command, **Read** to read back a response, or **Send & Read** to execute the command and read back the response.

Features and Functions

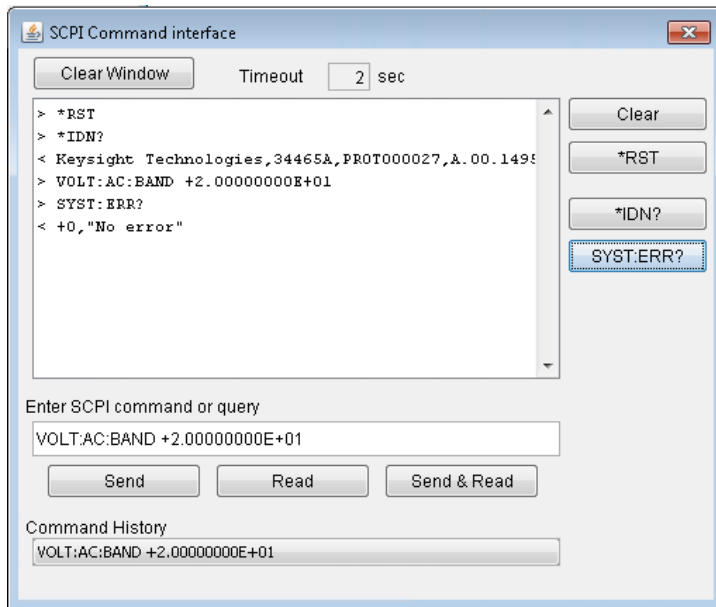

Run Autocal

In the *Allow Full Control* mode, click the **Run Autocal** button to perform an autocalibration (autocal). During the autocal, this button is grayed-out until the autocal is complete (typically 15 to 20 seconds).

Configuration Page

The Configuration page allows you to view the instrument's network configuration parameters, which configure the instrument to operate in your environment. To modify a parameter, click **Modify Configuration**.

Instrument Documentation and Technical Support | Keysight Site

34465A 6 1/2 Digit Multimeter

Configuration of your 34465A

Parameter	Currently in use
IP Address Configuration:	Automatic
IP Address:	169.254.4.61
Subnet Mask:	255.255.0.0
Default Gateway:	169.254.4.61
DNS Server(s):	
Desired Hostname	A-34465A-00027
Domain:	
Description:	Agilent 34465A Digital Multimeter - PROTO00027

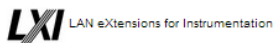



Help

Help is available for each of the tabs described above. For example:



34465A 6 1/2 Digit Multimeter

Configuration Page Help

The Configuration page allows you to view the instrument's network configuration parameters, which configure the instrument to operate in your environment. To modify a parameter, click **Modify Configuration**.

You may set or clear a password from the Modify Configuration page. The default is no password (disabled). If a password has been set, you will be prompted for it before going to the Modify Configuration and Browser Web Control pages.

The parameters on the Current Configuration page are:

- **IP Address Configuration**
If this is set to Automatic, the IP Address, Subnet Mask, and Default Gateway were determined automatically, either from DHCP or if a DHCP server was not found, from Dynamically Configured Link Local Addressing (Auto-IP). If it is set to Manual, the IP Address, Subnet Mask, and Default Gateway were set to the manually configured values.
- **IP Address**
This is used for TCP/IP communications with the instrument. The IP Address Configuration indicates how the address was determined.
- **Subnet Mask**
This parameter enables the instrument to determine whether an IP Address is on the same local subnet. When an address is on a different subnet, all packets must be sent to a gateway. The IP Address Configuration (above) indicates how the subnet mask was determined.
- **Default Gateway**
This is the IP address of the default gateway that allows the instrument to communicate with devices that are not on the local subnet. Packets that are destined for a device not on the local subnet, as determined by the subnet mask, are sent to the default gateway. The IP Address Configuration (above) indicates how the default gateway was determined.
- **DNS Server(s)**
These are the IP addresses of the Domain Name System (DNS) servers. The server provides a hostname for a given IP Address based on entries in its

Measurement Tutorial

Follow the suggestions in the sections below to achieve the greatest accuracy with Keysight Truevolt Series multimeters.

[Metrology](#)

[DC Measurement Considerations](#)

[Noise Rejection](#)

[Resistance Measurement Considerations](#)

[True RMS AC Measurements](#)

[Capacitance](#)

[Digitizing](#)

[Data Logging](#)

[Other Primary Measurement Functions](#)

[Level Triggering](#)

[High-Speed Measurements](#)

[Other Sources of Measurement Error](#)

Measurement Considerations

To achieve the greatest accuracy with the Keysight Truevolt Series multimeters, you must eliminate potential measurement errors. This chapter describes common errors and suggests ways to avoid them.

Metrology

The 34470A 7½-digit DMM is well-suited for high-accuracy metrology applications. Keysight has a number of application notes pertaining to maximizing measurement accuracy, such as:

[Practical Tips for Optimizing Measurement Accuracy with your Digital Multimeter](#) - This Web page has a number of links to application notes addressing DMM measurement errors and how to make temperature measurements.

[Making Better Measurements with your Digital Multimeter](#) - This Web page has a number of links to application notes addressing better RMS measurements, system cabling errors, DC, frequency, and period measurement errors, and AC voltage measurement errors.

[Make Better AC Measurements with Your Digital Multimeter](#) - Focuses on AC measurement accuracy.

[Make Better RMS Measurements with Your Digital Multimeter](#) - Focuses on RMS measurement accuracy.

[Practical Temperature Measurements](#) - A detailed tutorial describing how to make accurate temperature measurements.

Search www.keysight.com for application notes that address your measurement and accuracy needs.

DC Measurement Considerations

Thermal EMF Errors

Thermoelectric voltages are the most common error source in low-level DC voltage measurements. Thermoelectric voltages are generated by circuit connections using dissimilar metals at different temperatures. Each metal-to-metal junction forms a thermocouple that generates a voltage proportional to the junction temperature, as shown in the table below. You should minimize thermocouple voltages and temperature variations in low-level voltage measurements. The best connections use copper-to-copper crimped connections, as the DMM's input terminals are a copper alloy.

Copper to:	Approx. $\mu\text{V} / ^\circ\text{C}$
Cadmium-Tin Solder	0.2
Copper	<0.3
Gold	0.5
Silver	0.5
Brass	3
Beryllium Copper	5
Aluminum	5
Tin-Lead Solder	5
Kovar or Alloy 42	40
Silicon	500
Copper Oxide	1000

Loading Errors (DC Voltage)

Measurement loading errors occur when the resistance of the DUT is an appreciable percentage of the multimeter's input resistance, as shown below.

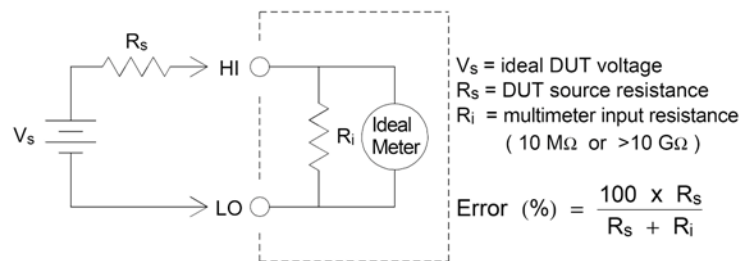

To reduce the effects of loading errors and to minimize noise pickup, set the multimeter's input resistance to >10 G Ω (high-impedance) for the 100 mVDC, 1 VDC, and 10 VDC ranges. The input resistance is maintained at 10 M Ω for the 100 VDC and 1000 VDC ranges.

Noise Rejection

Rejecting Power-Line Noise Voltages

A desirable characteristic of integrating analog-to-digital (A/D) converters is their ability to reject power-line related noise present with DC input signals. This is called normal mode noise rejection, or NMR. The multimeter achieves NMR by measuring the average DC input by "integrating" it over a fixed period. If you set the integration time to a whole number of power line cycles (PLCs), these errors (and their harmonics) will average out to approximately zero.

The multimeter provides three integration selections (1, 10, and 100 PLCs) that achieve NMR. The multimeter measures the power-line frequency (50 Hz or 60 Hz), and then determines the corresponding integration time. For a complete listing of NMR, approximate added rms noise, reading rate, and resolution for each integration setting, see the Performance vs. Integration Time table.

Common Mode Rejection (CMR)

Ideally, a multimeter is completely isolated from earth-referenced circuits. However, there is finite resistance between the multimeter's input LO terminal and earth ground, as shown below. This can cause errors when measuring low voltages which are floating relative to earth ground.

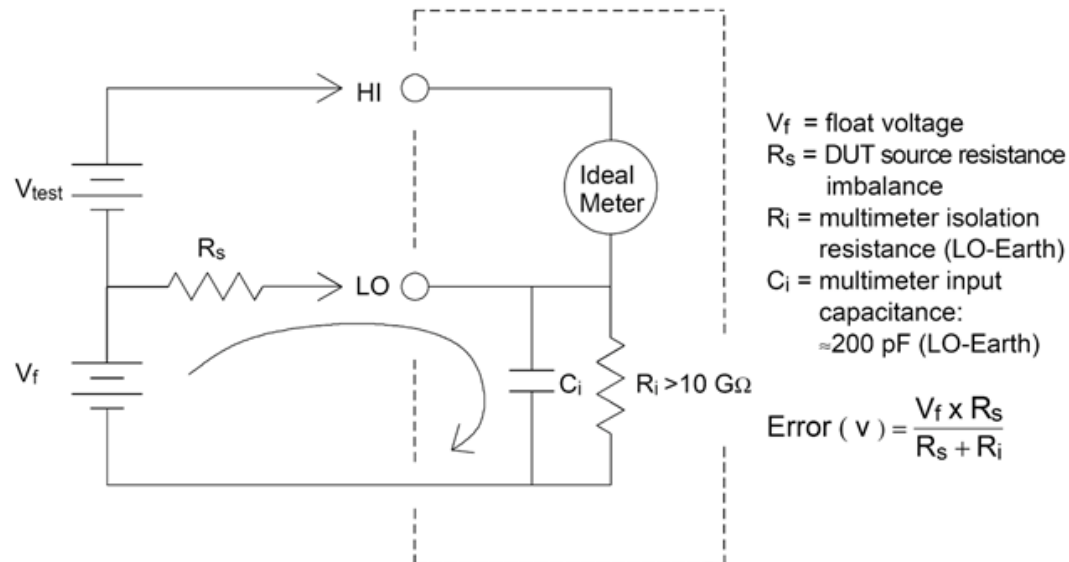

Noise Caused by Magnetic Loops

When making measurements near magnetic fields, avoid inducing voltages in the measurement connections. You should be especially careful when working near conductors carrying large currents. Use twisted-pair connections to the multimeter to reduce the noise pickup loop area, or dress the test leads as close together as possible. Loose or vibrating test leads will also induce error voltages. Tie down test leads securely when operating near magnetic fields. Whenever possible, use magnetic shielding materials or increased distance from magnetic sources.

Noise Caused by Ground Loops

When measuring voltages in circuits where the multimeter and the DUT are referenced to a common earth ground, a "ground loop" is formed. As shown below, any voltage difference between the two ground reference points (V_{ground}) causes current to flow through the measurement leads. This causes noise and offset voltage (usually power-line related), which are added to the measured voltage.

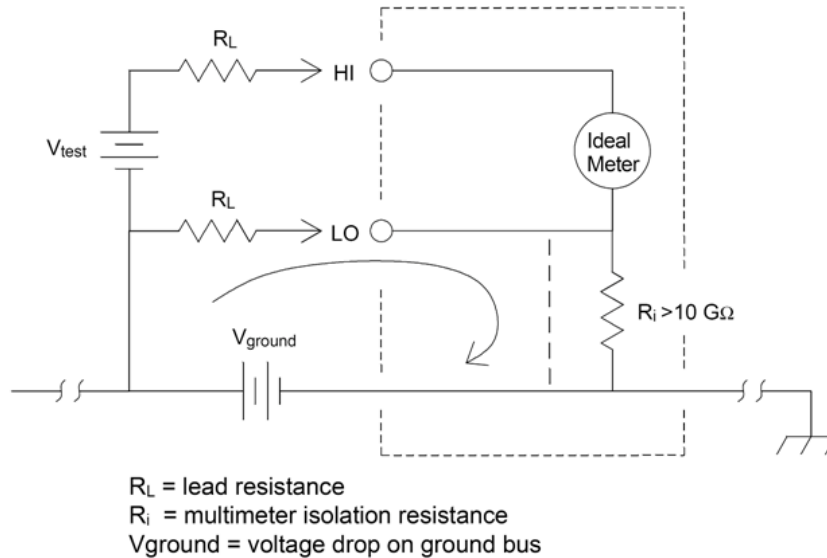

The best way to eliminate ground loops is to isolate the multimeter from earth by not grounding the input terminals. If the multimeter must be earth-referenced, connect it and the DUT to one common ground point. Also connect the multimeter and DUT to the same electrical outlet whenever possible.

Resistance Measurement Considerations

The multimeter offers two resistance measurements: 2-wire and 4-wire ohms. For both methods, the test current flows from the input HI terminal, through the resistor being measured. For 2-wire ohms, the voltage drop across the resistor being measured is sensed internal to the multimeter. Therefore, test lead resistance is also measured. For 4-wire ohms, separate "sense" connections are required. Because no current flows in the sense leads, the resistance in these leads does not give a measurement error.

NOTE The errors mentioned earlier in this chapter for DC voltage measurements also apply to resistance measurements. Additional error sources unique to resistance measurements are discussed below.

The 4-wire ohms method provides the most accurate way to measure small resistances because it reduces test lead and contact resistances. This is often used in automated test applications where resistive and/or long cable, numerous connections, or switches exist between the multimeter and the DUT. The recommended connections for 4-wire ohms measurements are shown below.

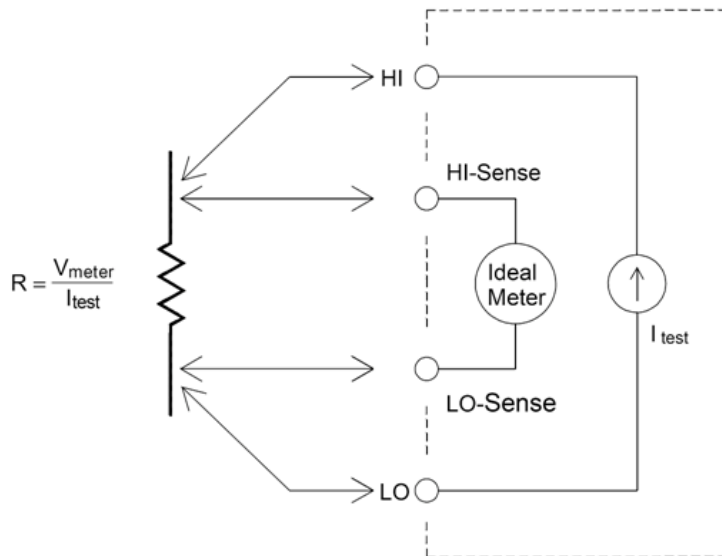

For the 34465A and 34470A, you can also enable offset compensated resistance measurements using [\[SENSe\]:\[RESistance|RESistance\]:OCOMPensated {OFF|ON}](#). Offset compensation removes the effects of small dc voltages in the circuit being measured. The technique involves taking the difference between two resistance measurements, one with the current source set to the normal value, and one with the current source set to a lower value.

Removing Test Lead Resistance Errors

To eliminate offset errors associated with test lead resistance in 2-wire ohms measurements, follow these steps:

Short the test lead ends together and read the displayed test lead resistance.

Press **Null**. The multimeter will store the test lead resistance as the 2-wire ohms null value, and subtract that value from subsequent measurements.

See also "Null Measurements."

Minimizing Power Dissipation Effects

When measuring resistors designed for temperature measurements (or other resistive devices with large temperature coefficients), be aware that the multimeter will dissipate some power in the DUT. The following table shows several examples.

Range	Standard Test Current	Power Dissipation in DUT
1 G Ω	500 nA	2.5 μ W
100 M Ω	500 nA	2.5 μ W
10 M Ω	500 nA	2.5 μ W
1 M Ω	5 μ A	25 μ W
100 k Ω	10 μ A	10 μ W
10 k Ω	100 μ A	100 μ W
1 k Ω	1 mA	1 mW
100 Ω	1 mA	100 μ W

If power dissipation is a problem, you should select a higher fixed range (all multimeter models) or, for the 34465A/70A, select the low power resistance measurement mode (see [Resistance](#) (front panel), or [\[SENSe:\]{RESistance|FREsistance}:POWer:LIMit\[::STATe\]](#) (remote)). The low power mode sources less test current per measurement range than is normally sourced for standard resistance measurements, to reduce power dissipation and self-heating in the DUT. The following table shows the various resistance ranges, the standard test current delivered for 2- and 4-wire resistance measurements, and the low power mode test current.

Range	Standard Test Current	Low Power Mode Test Current
1 G Ω	500 nA	500 nA
100 M Ω	500 nA	500 nA
10 M Ω	500 nA	500 nA
1 M Ω	5 μ A	5 μ A
100 k Ω	10 μ A	5 μ A
10 k Ω	100 μ A	10 μ A
1 k Ω	1 mA	100 μ A
100 Ω	1 mA	100 μ A



Errors in High Resistance Measurements

When you are measuring large resistances, significant errors can occur due to insulation resistance and surface cleanliness. You should take the necessary precautions to maintain a "clean" high-resistance system. Test leads and fixtures are susceptible to leakage due to moisture absorption in insulating materials and "dirty" surface films. Nylon and PVC are relatively poor insulators ($10^9 \Omega$) when compared to PTFE insulators ($10^{13} \Omega$). Leakage from nylon or PVC insulators can easily contribute a 0.1% error when measuring a 1 M Ω resistance in humid conditions.

True RMS AC Measurements

True rms responding multimeters, like the Keysight Truevolt Series, measure the "heating" potential of an applied voltage. Power dissipated in a resistor is proportional to the square of an applied voltage, independent of the waveshape of the signal. This multimeter accurately measures true rms voltage or current, as long as the wave shape contains negligible energy above the meter's effective bandwidth.

The Keysight Truevolt Series uses the same techniques to measure true rms voltage and true rms current. The effective AC voltage bandwidth is 300 kHz, while the effective AC current bandwidth is 10 kHz.

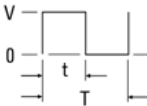
Waveform Shape	Crest Factor (C.F.)	AC RMS	AC + DC RMS	Average Responding Error
	1.414	$\frac{V}{1.414}$	$\frac{V}{1.414}$	Calibrated for 0 error
	1.732	$\frac{V}{1.732}$	$\frac{V}{1.732}$	-3.9%
	$\sqrt{\frac{T}{t}}$	$\frac{V}{C.F.} \times \sqrt{1 - \left(\frac{1}{C.F.}\right)^2}$	$\frac{V}{C.F.}$	-46% for C.F. = 4

The DMM's AC voltage and AC current functions measure the AC-coupled true rms value. In this DMM, the "heating value" of only the AC components of the input waveform are measured (dc is rejected). As seen in the figure above; for sine waves, triangle waves, and square waves, the AC-coupled and AC+DC values are equal, because these waveforms do not contain a DC offset. However, for non-symmetrical waveforms (such as pulse trains) there is a DC voltage content, which is rejected by Keysight's AC-coupled true rms measurements. This can provide a significant benefit.

An AC-coupled true rms measurement is desirable when you are measuring small AC signals in the presence of large DC offsets. For example, this situation is common when measuring AC ripple present on DC power supplies. There are situations, however, where you might want to know the AC+DC true rms value. You can determine this value by combining results from DC and AC measurements, as shown below:

$$ac + dc = \sqrt{ac^2 + dc^2}$$

For the best AC noise rejection, you should perform the DC measurement using an integration time of at least 10 power-line cycles (PLCs).

True RMS Accuracy and High-Frequency Signal Content

A common misconception is that because an AC multimeter is true rms, its sine wave accuracy specifications apply to all waveforms. Actually, the shape of the input signal dramatically affects measurement accuracy for any multimeter, especially when that input signal contains high-frequency the instrument's bandwidth.

For example, consider a pulse train, one of the most challenging waveforms for a multimeter. The pulse width of that waveform largely determines its high-frequency content. The frequency spectrum of an individual pulse is determined by its Fourier Integral. The frequency spectrum of the pulse train is the Fourier Series that samples along the Fourier Integral at multiples of the input pulse repetition frequency (prf).

The figure below shows the Fourier Integral of two very different pulses: one of broad width (200 μs); the other narrow (6.7 μs). The bandwidth of the ACV path in the DMM is 300 kHz; therefore, frequency content above 300 kHz is not measured.

Notice that the $\frac{\sin(\pi fT)}{\pi fT}$ spectrum of the narrow pulse significantly exceeds the effective bandwidth of the instrument. The net result is a less accurate measurement of the narrow, high-frequency pulse.

In contrast, the frequency spectrum of the broad pulse has fallen off significantly below the multimeter's 300 kHz (approximately) bandwidth, so measurements of this pulse are more accurate.

Reducing the prf increases the density of lines in the Fourier spectrum, and increases the portion of the input signal's spectral energy within the multimeter's bandwidth, which improves accuracy.

In summary, error in rms measurements arise when there is significant input signal energy at frequencies above the multimeter's bandwidth.

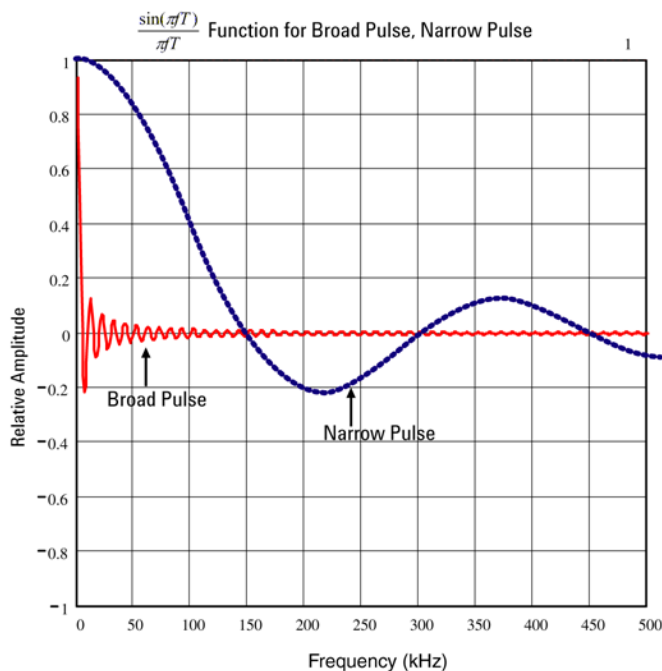

Estimating High-Frequency (Out-of-Band) Error

A common way to describe signal waveshapes is to refer to their "Crest Factor". Crest factor is the ratio of the peak value to rms value of a waveform. For a pulse train, for example, the crest factor is approximately equal to the square root of the inverse of the duty cycle.

$$CF = \frac{1}{\sqrt{d}} = \frac{1}{\sqrt{\frac{t_p}{T}}} = \frac{1}{\sqrt{prf \times t_p}}$$

Notice that crest factor is a composite parameter, dependent upon the pulse width and repetition frequency; crest factor alone is not enough to characterize the frequency content of a signal.

Traditionally, DMMs include a crest factor derating table that applies at all frequencies. The measurement algorithm used in the Truevolt Series DMMs is not inherently sensitive to crest factor, so no such derating is necessary. With this multimeter, as discussed in the previous section, the focal issue is high-frequency signal content which exceeds the multimeter's bandwidth.

For periodic signals, the combination of crest factor and repetition rate can suggest the amount of high-frequency content and associated measurement error. The first zero crossing of a simple pulse occurs at $f_1 = 1/t_p$.

This gives an immediate impression of the high-frequency content by identifying where this crossing occurs as a function of crest factor: $f_1 = (CF^2)(prf)$.

The following table shows the typical error for various pulse waveforms as a function of input pulse frequency:

Typical error for square wave, triangle wave, and pulse trains of CF=3, 5, or 10					
prf	square wave	triangle	CF=3	CF=5	CF=10
200	-0.02%	0.00%	-0.04%	-0.09%	-0.34%
1000	-0.07%	0.00%	-0.18%	-0.44%	-1.71%
2000	-0.14%	0.00%	-0.34%	-0.88%	-3.52%
5000	-0.34%	0.00%	-0.84%	-2.29%	-8.34%
10000	-0.68%	0.00%	-1.75%	-4.94%	-26.00%
20000	-1.28%	0.00%	-3.07%	-8.20%	-45.70%
50000	-3.41%	-0.04%	-6.75%	-32.0%	-65.30%
100000	-5.10%	-0.12%	-21.8%	-50.6%	-75.40%

This table gives an additional error for each waveform, to be added to the value from the accuracy table provided in the instrument's data sheet

The specifications are valid for $CF \leq 10$, provided there is insignificant signal energy above the 300 kHz bandwidth for voltage, or the 10 kHz bandwidth for current. Multimeter performance is not specified for $CF > 10$, or when significant out-of-band signal content is present.

Example

A pulse train with level 1 V_{rms}, is measured on the 1 V range. It has pulse heights of 3 V (that is, a Crest Factor of 3) and duration 111 μ s. The prf can be calculated to be 1000 Hz, as follows:

$$prf = \frac{1}{CF^2 \times t_p}$$

Thus, from the table above, this AC waveform can be measured with 0.18 percent additional error.

Other Primary Measurement Functions

Frequency and Period Measurement Errors

The multimeter uses a reciprocal counting technique to measure frequency and period. This method generates constant measurement resolution for any input frequency. The multimeter's AC voltage measurement section performs input signal conditioning. All frequency counters are susceptible to errors when measuring low-voltage, low-frequency signals. The effects of both internal noise and external noise pickup are critical when measuring "slow" signals. The error is inversely proportional to frequency. Measurement errors also occur if you attempt to measure the frequency (or period) of an input following a DC offset voltage change. You must allow the multimeter's input DC blocking capacitor to fully settle before making frequency measurements.

DC Current

When you connect the multimeter in series with a test circuit to measure current, a measurement error is introduced. The error is caused by the multimeter's series burden voltage. A voltage is developed across the wiring resistance and current shunt resistance of the multimeter, as shown below.

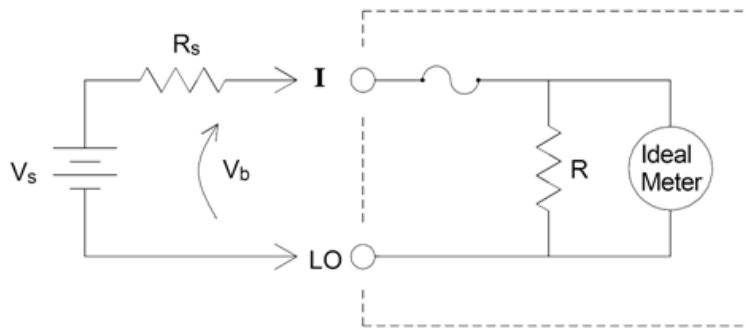

V_s = source voltage
 R_s = DUT source resistance
 V_b = multimeter burden voltage
 R = multimeter current shunt

$$\text{Error (\%)} = \frac{-100\% \times V_b}{V_s}$$

Avoid applying signals to unused current input terminals

If signal inputs are applied to terminals not needed for the current measurement, measurement errors may occur. The unused terminals are still protected but the un-needed signals may interfere with current measurement. For example, applying inputs to the 3A terminals while making measurements on the 10A terminals will typically cause errors.

The Hi and Lo sense terminals are not used for many measurements. Applying signals here when not needed can also cause errors. AC or DC voltages above 15 volts peak on the un-needed sense terminals are likely to cause measurement errors. If unexpected errors are occurring, signals on the un-needed terminals is an area to check.

Temperature Measurements

Temperature measurements require a temperature transducer probe. The supported probes are 2-wire and 4-wire RTDs, 2-wire and 4-wire thermistors (5 k 44007 type, see Thermistor Requirements below), and, for the 34465A/70A only, type E, J, K, N, R, or T thermocouples.

Probe Type Choice

RTD's provide very accurate, highly linear relationships between resistance and temperature, over a range of roughly -200 to 500 °C. There is very little conversion complexity for an RTD because it is so intrinsically linear. The multimeter provides measurement for the IEC751 standard RTD, which has a sensitivity of $0.385\%/^{\circ}\text{C}$.

Thermistors consist of semiconductor materials, and provide roughly ten times the sensitivity of the RTD. Because they are semiconductors, their temperature range is more limited, commonly to -80 to 150 °C. Thermistors have highly non-linear temperature-resistance relationships; therefore their conversion algorithms are more complex. The Truevolt Series multimeters use the standard Hart-Steinhart Approximation to provide accurate conversions, with a typical resolution of $.08$ °C.

Thermistor Requirements

The DMM converts the measured thermistor resistance to temperature using the Steinhart-Hart thermistor equation:

$$1/T = A + B (\ln(R)) + C (\ln(R))^3$$

Where:

A, B, and C are constants provided by the thermistor manufacturer and derived from three temperature test points.

R = Thermistor resistance in Ω .

T = Temperature in degrees K.

Important: Use only a $5\text{ k}\Omega$ 44007-type thermistor. This type thermistor has constants of $A = 1.285\text{e-}3$, $B = 2.362\text{e-}4$, $C = 9.285\text{e-}8$. Using an incorrect type of thermistor can result in errors greater than 20 °C for a temperature being measured of 100 °C.

For a detailed tutorial on temperature measurements, refer to Keysight Application Note 290 *Practical Temperature Measurements* available at www.keysight.com.

2-Wire vs. 4-Wire Measurements

As with resistance measurements, four-wire temperature measurements are more accurate, because errors due to lead wire resistance are completely eliminated. Alternately, you can use the multimeter's Null function to remove the test lead resistance from the measurement (see NULL Reading below.)

NULL Reading

The DMM allows a separate null setting to be saved for the temperature function. When making null measurements, each reading is the difference between a stored null value and the input signal. One application of NULL is to increase accuracy of two-wire resistance measurements by first nulling the closed-circuit test lead resistance.

Autozero On/Off

Enabling the autozero feature (ON) provides greater accuracy; however, the additional measurement (of zero) reduces the reading speed.

Making High-Speed AC Measurements

The multimeter's AC voltage and AC current functions implement three low-frequency filters. These filters allow you to trade-off minimum measured frequency for faster reading speed. The FAST filter settles in 0.025 seconds, and is useful for frequencies above 200 Hz. The MEDIUM filter settles in 0.625 seconds for voltage and 0.25 seconds for current, and is useful for measurements above 20 Hz. The SLOW filter settles in 2.5 seconds for voltage and 1.66 seconds for current, and is useful for frequencies above 3 Hz.

With a few precautions, you can perform AC measurements at speeds up to 500 readings per second. Use manual ranging to eliminate autoranging delays. By setting the trigger delay to 0, the FAST, MEDIUM, and SLOW filters allow up to 500, 150, and 50 readings per second, but with reduced accuracy because the filter may not fully settle. If the sample-to-sample levels are similar, little settling time is required for each new reading. Under this specialized condition, the MEDIUM filter provides reduced accuracy results at 20 readings per second, and the FAST filter provides reduced accuracy results at 200 readings per second.

AC Filter	Filter Bandwidth	Settling Time (s)		Full Settling (rdgs/s)		Partial Settling	Maximum rdgs/s
		ACV	ACI	ACV	ACI	ACV/ACI	ACV/ACI
Slow	3 Hz	2.5	1.67	0.4	0.6	2	50
Medium	20 Hz	0.63	0.25	1.6	4	20	150
Fast	200 Hz	0.025	0.025	40	40	200	500

In applications where sample-to-sample levels vary widely, but the DC offset level does not change, the MEDIUM filter settles at 2 to 4 readings per second (depending upon the lowest frequency component in the waveform) as shown in the following table:

Lowest Frequency Component	20 Hz	50 Hz	100 Hz	200 Hz
AC Current (allowable rate in rdgs/s)	4	4	4	4
AC Voltage (allowable rate in rdgs/s)	2	3	4	4

For AC voltage, additional settling time may be required when the DC level varies from sample to sample. The default sample delays allow for a DC level change of 3% of range for all filters. If the DC level change exceeds these levels, additional settling time is required. The multimeter's DC blocking circuitry has a settling time constant of 0.2 seconds. This settling time only affects measurement accuracy when DC offset levels vary from sample to sample. If maximum measurement speed is desired, you may want to add an

external DC blocking circuit for circuitry with significant DC voltages present. This circuit can be as simple as a resistor and a capacitor.

For AC current, additional settling time is not required when the DC level varies sample to sample.

Making High-Speed DC and Resistance Measurements

If you have the DIG (digitizing) option, simply select **[Acquire] > Digitize** to select the fastest DCV or DCI measurements. If you do not have the DIG option, or for resistance measurements, to make the fastest (but least accurate) DC or resistance measurements:

- Set the integration time (NPLC or aperture) to minimum
- Select a fixed range (autorange off)
- Disable autozero
- Disable offset compensation (resistance measurements)

Refer to the particular measurement type in [Measurements](#) for more information on the above functions.

Capacitance

The multimeter makes capacitance measurements by applying a known current to charge the capacitance and then a resistance to discharge as shown below:

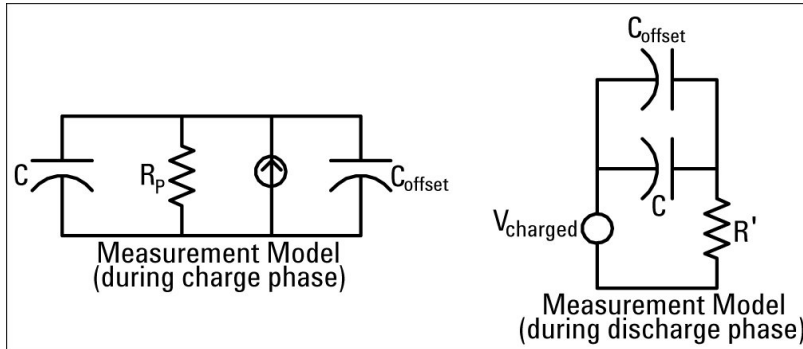

An illustration of the response curve while charging is shown below:

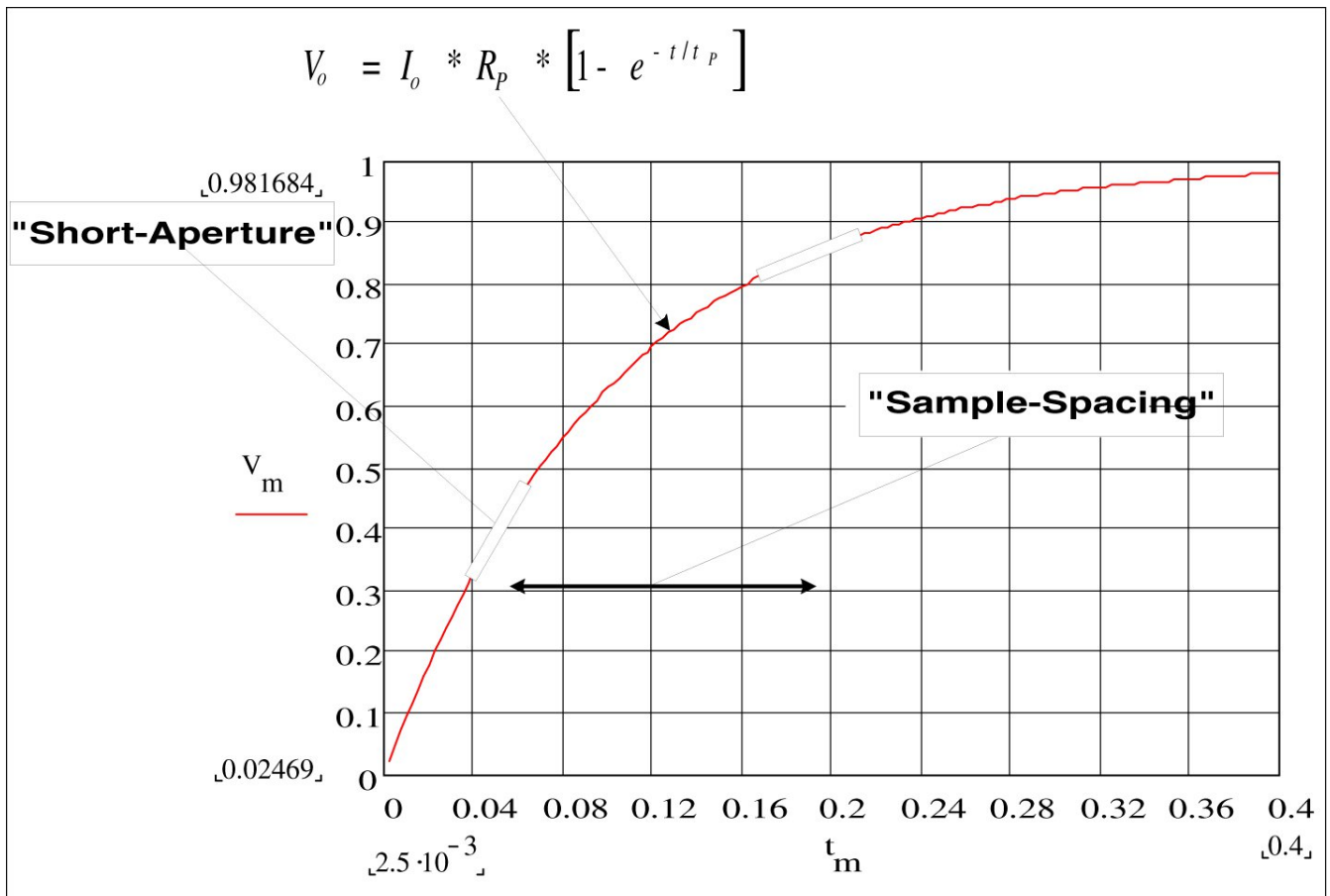

Capacitance is calculated by measuring the change in voltage (DV) that occurs over a “short aperture” time, (Dt). This measurement is repeated at two different times during the exponential rise that occurs. An algorithm takes the data from these four points, and by linearizing that exponential rise over these “short apertures”, accurately calculates the capacitance value.

The measurement cycle consists of two parts: a charge phase (shown in the graph) and a discharge phase. The time–constant during the discharge phase is longer, due to a 100 k Ω protective resistor in the measurement path. This time–constant plays an important role in the resultant reading rate (measurement time). The incremental times (or “sample times”) as well as the width of the “short apertures”, vary by range, in order to minimize noise and increase reading accuracy.

For the best accuracy, take a zero null measurement with open probes, to null out the test lead capacitance, before connecting the probes across the capacitor to be measured (see [Capacitance Measurements](#) for details).

Capacitance Measurement Considerations

Capacitors that have a high dissipation factor or other non-ideal characteristics will affect capacitance measurements. Capacitors with high dissipation factors may exhibit a variance between the measured value using the multimeter versus the single frequency method of some other LCR meters. The single frequency method will also see more variation at different frequencies. For example, some inexpensive capacitance substitution boxes, when measured with the multimeter, are almost 5% different compared to the same capacitance measured with the single frequency method of an LCR meter. The LCR meter will also show different values at different frequencies.

Capacitors with long time constants (dielectric absorption) will result in slow measurement settling time, and will take a number of seconds to stabilize. You may see this when first connecting a capacitor or when the delay time to make a measurement is varied. A high quality film capacitor typically shows the least of this and an electrolytic capacitor the most, with ceramic capacitors typically in between.

Digitizing Measurements

The digitize mode applies only to the 34465A/70A with the DIG option, and as is available only from the DMM's front panel. The digitized mode provides a front-panel user interface that allows you to quickly set up digitized measurements.

Digitizing is the process of converting a continuous analog signal, such as a sine wave, into a series of discrete samples (readings). The figure below shows the result of digitizing a sine wave. This chapter discusses the various ways to digitize signals. The importance of the sampling rate, and how to use level triggering.

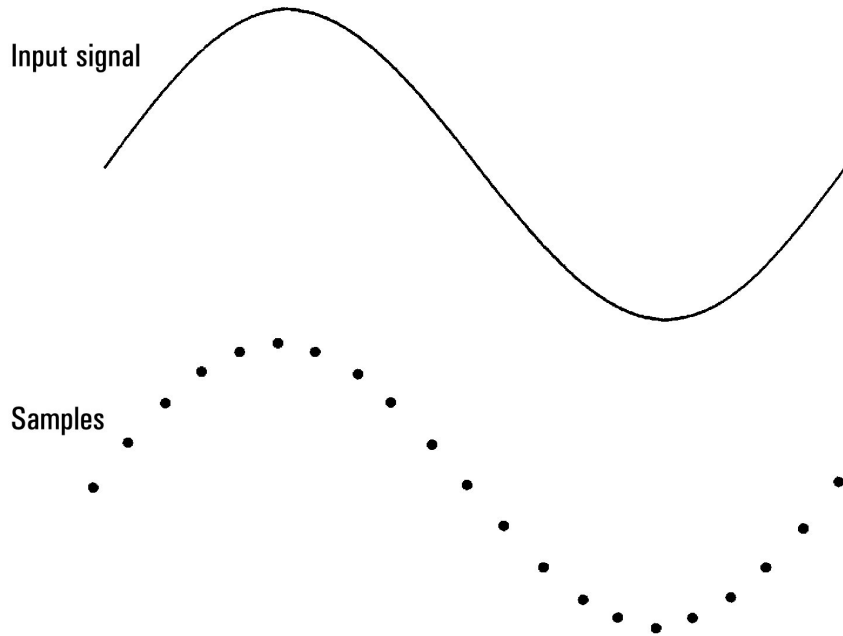

The Sampling Rate

The Nyquist or Sampling Theorem states: *If a continuous, bandwidth-limited signal contains no frequency components higher than F , then the original signal can be recovered without distortion (aliasing) if it is sampled at a rate that is greater than $2F$ samples per second.*

In practice, the multimeter's sampling rate must be greater than twice the highest frequency component of the signal being measured. From the front panel you can select a sample rate in samples per second using the **Sample Rate** softkey. You can also set the sample rate indirectly by specifying the sample interval (the time from the beginning of one sample to the beginning of the next sample) using the **Sample Interval** softkey.

The figure below shows a sine wave sampled at a rate slightly less than $2F$. As shown by the dashed line, the result is an alias frequency which is much different than the frequency of the signal being measured. Some digitizers have a built-in anti-aliasing low-pass filter with a sharp cutoff at a frequency equal to $1/2$ the digitizer's sampling rate. This limits the bandwidth of the input signal so that aliasing cannot occur. Since the multimeter has a variable sample rate for DCV digitizing, and to preserve the upper bandwidth

for high-frequency measurements, no anti-aliasing filter is provided in the multimeter. If you are concerned about aliasing, you should add an external anti-aliasing filter.

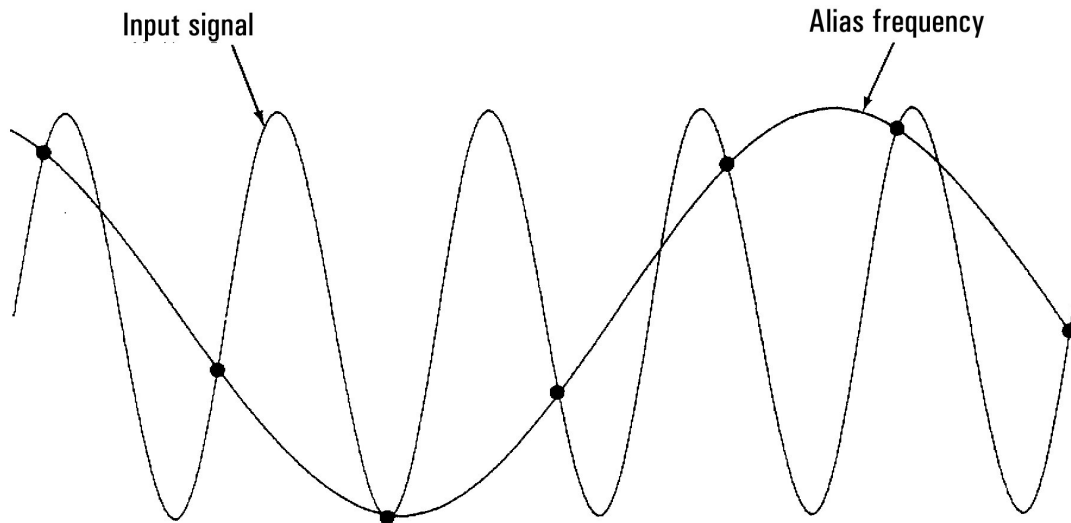

Some digitizers have a built-in anti-aliasing low-pass filter with a sharp cutoff at a frequency equal to $1/2$ the digitizer's sampling rate. This limits the bandwidth of the input signal so that aliasing cannot occur. Since the multimeter has a variable sample rate for DCV digitizing, and to preserve the upper bandwidth for high-frequency measurements, no anti-aliasing filter is provided in the multimeter. If you are concerned about aliasing, you should add an external anti-aliasing filter.

Level Triggering

When digitizing, it is important to begin sampling at some defined point on the input signal such as when the signal crosses zero volts or when it reaches the midpoint of its positive or negative peak amplitude. Level triggering allows you to specify when (with respect to voltage and slope) to begin sampling. Refer to [Level Triggering](#) for more information.

About Digitize Mode

- Digitizing is available only for the 34465A/70A and requires the DIG option.
- Digitizing allows you to take samples of the input signal, at a specified Sample Rate (for example, 50 kHz) or Sample Interval (for example, 20 μ S). You can specify the Duration as either an amount of Time or a number of Readings (samples). You can use either auto, external, or level triggering. After pressing **[Acquire]**, press **Acquire > Digitize**. You can then select the digitizing/triggering parameters. After configuring the digitizing parameters, press **[Run/Stop]**. Digitizing will begin when the specified trigger event occurs.
- Digitize mode is available only from the front panel and can only be used for DCV or DCI measurement functions.

Measurement Tutorial

- When you specify digitizing settings that conflict with present settings, the instrument displays a message, and in most cases, adjusts settings to legal values. For example, if you configure digitizing for a greater sample rate than can be achieved with the present integration time (NPLC setting), the instrument displays a message and reduces the integration time. When you see a displayed message, such as *NPLC setting reduced to achieve digitize rate/interval*, you can press **Shift > Help > 1 View the last message displayed > Select** to view more information.
- The DIG option increases the maximum reading rates from 5k readings/s (standard) to 50k readings/s (maximum).
- The DIG option enables pretriggering, level triggering, and trigger delay capability.
- With the DIG option, level triggering, pretriggering, and sample timer capabilities are enabled when using the DMM from remote. From the front panel, level trigger is available for digitizing and for certain measurement functions in continuous mode (see [Level Triggering](#) for more information). Pretrigger front panel controls are only available in the digitize mode. The sample timer controls are available from the front panel for all measurement modes.
- For pretrigger, if a trigger comes before all pretriggers are received, trigger is executed to begin readings.
- While digitizing, **Digitizing** flashes near the top of the display. When stopped, **Digitize Stopped** is displayed. While digitizing, the remaining time and remaining samples are displayed near the bottom of the display.



- All samples taken during digitizing are saved in volatile memory. After completing a digitize operation, press the **Save Readings** softkey and specify a file to save the digitized readings to a file.
- The maximum number of readings that can be captured is based on volatile memory space available.
- Reading store is cleared at the start of a new acquisition.
- The slowest sample rate for digitizing is 20 ms (1 PLC); the fastest is 20 μ s (.001 PLC).
- Any display mode can be set to view data during acquisition but responsiveness to data views may not respond until data acquisition is complete. After acquisition is complete – trend chart pan, zoom, and cursors can be used to review data.
- Statistics and histogram data are calculated after the digitizing is completed.

Data Log and Digitizing Local Remote Interaction

CAUTION

Loss of data possible - local to remote transition clears instrument memory: When data logging or digitizing *to memory*, if you access the instrument from remote (send a SCPI or common command)* and then return to local (by pressing [**Local**]), the readings in memory are cleared and the instrument returns to Continuous mode.

For data logging only, you can prevent this situation by data logging to a file instead of to memory (see [Data Log Mode](#) for details). You can also prevent this from happening for data logging or digitizing by taking steps to keep the instrument from being accessed from remote. To prevent remote access, you may want to disconnect the LAN, GPIB, and USB interface cables from the instrument before starting the measurements. To prevent remote access via LAN, you can connect the instrument behind a router to minimize the possibility of remote access. You can also disable the various I/O interfaces from the front panel menus under [**Utility**] > **I/O Config**.

To view the status of a data logging or digitizing operation remotely, use the instrument's [Web User Interface](#). The Web User Interface monitor does not set the instrument to remote.

**When accessed from remote, the instrument will continue data logging or digitizing to completion, and you can retrieve the readings from remote.*

Data Log Mode

The Data Log mode is standard on the 34465A and 34470A only, as is available only from the DMM's front panel. Data Log mode provides a front-panel user interface that allows you to set up data logging into the instrument's non-volatile memory, or to internal/external file(s), without programming, and without a connection to a computer. Once you have finished collecting data, you can view it from the front panel, or you can transfer the data to your computer. Data Log mode allows you to log a specified number of readings, or readings acquired for a specified period of time, to instrument memory or to internal or external data files.

To select Data Log mode, press **[Acquire] Acquire > Data Log**. You can then select the Sample Interval (time between measurements - for example, 500 mS), Duration as either an amount of Time or a number of Readings, whether to Start after a Delay or at a specific Time of Day, and whether to Log to Memory or Log to File(s). After configuring the data logging parameters, press **[Run/Stop]**. Data logging will begin following the specified Delay or at the specified Time of Day.

CAUTION

Loss of data possible - local to remote transition clears instrument memory: When data logging or digitizing *to memory*, if you access the instrument from remote (send a SCPI or common command)* and then return to local (by pressing **[Local]**), the readings in memory are cleared and the instrument returns to Continuous mode.

For data logging only, you can prevent this situation by data logging to a file instead of to memory (see [Data Log Mode](#) for details). You can also prevent this from happening for data logging or digitizing by taking steps to keep the instrument from being accessed from remote. To prevent remote access, you may want to disconnect the LAN, GPIB, and USB interface cables from the instrument before starting the measurements. To prevent remote access via LAN, you can connect the instrument behind a router to minimize the possibility of remote access. You can also disable the various I/O interfaces from the front panel menus under **[Utility] > I/O Config**.

To view the status of a data logging or digitizing operation remotely, use the instrument's [Web User Interface](#). The Web User Interface monitor does not set the instrument to remote.

**When accessed from remote, the instrument will continue data logging or digitizing to completion, and you can retrieve the readings from remote.*

Data Log Mode Features

- The Data Log mode is available for DC voltage, DC current, AC voltage, AC current, 2-wire and 4-wire resistance, frequency, period, temperature, capacitance, and ratio measurements. The Data Log mode is not available for the continuity or diode functions.
- The maximum data log rate is 1000 readings/sec. Note: The maximum reading rate may be limited by settings already configured when entering data log mode (particularly NPLC settings for DC and resistance measurements). In this situation, press the measurement function key (for example, DCV) and decrease the aperture setting (either NPLC or Time).

- Data Log mode settings and measurement settings interact. These include the sample interval, destination (memory or file), measurement function, NPLC, Aperture, Autorange, Autozero, Offset Compensation, AC Filter, TC Open Check, and Gate Time. When you specify data log settings that conflict with present settings, the instrument displays a message, and in most cases, adjusts settings to legal values. For example, if you configure data logging for more readings than can be saved to reading memory, the instrument displays a message and reduces the maximum number of readings. When you see a displayed message, such as *The data logging Sample Interval increased*, you can press **Shift > Help > 1 View the last message displayed > Select** to view more information.
- The maximum data logging duration is 100 hours, the minimum is 1 second.
- By default, data logging implements auto trigger. The level and external trigger sources are not supported for data logging.
- When the data log mode is running, **Data Logging** flashes near the top of the display, and the log file path (when data logging to a file) remaining time, and remaining samples is displayed near the bottom of the display.

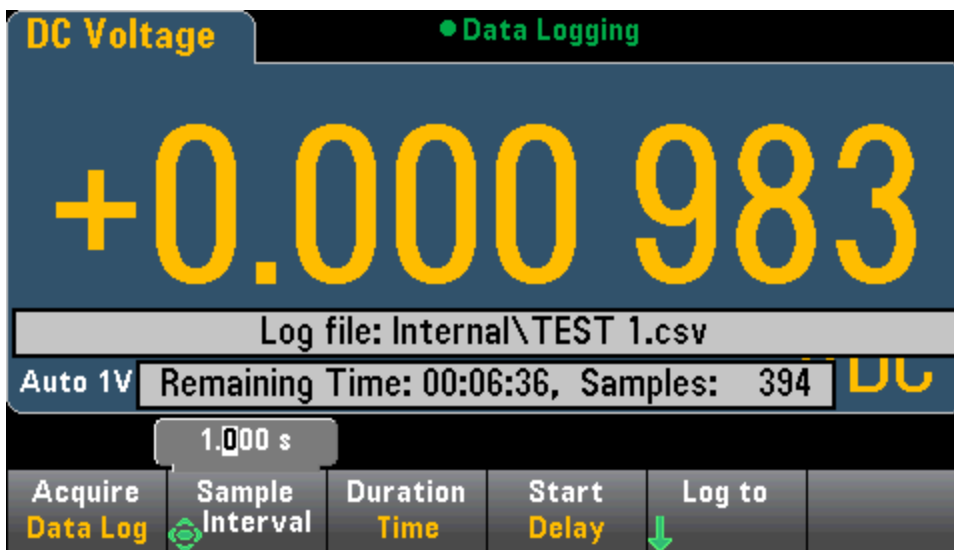

- You can store data logging readings in volatile memory for display or write the readings to one or more files.
- When data logging to memory, the data is volatile (not remaining during power off) but can be saved to an internal or external file after data logging is complete. The number of readings you can store in memory depends on the MEM option. With the MEM option, the limit is 2,000,000 readings. Without the MEM option, the limit is 50,000 readings.
- When data logging to file(s):
 - You can append the data logging start date and time to the file name using the format: `_YYYYMMDD_HHMMSS`. For example, for a file named *Data*, the result will be similar to *Data_20140720_032542.csv*.
 - You specify internal or external and a file name. If more than one file needs to be created to hold the data, the second filename will be appended with `_00001`, the third filename with `_00002`, and so on. When data logging to files, the maximum number of readings you can data log to files is 100 hours x 1000rdgs/sec = 360,000,000.

Measurement Tutorial

- As shown in the sample data file graphic below, when **Metadata** is **On**, (see [Data Logging/Options](#) for details), each data log file contains a Start Date and Start Time showing when the first reading was taken, the reading numbers, the sample interval, and the reading data. You can specify a comma, tab, or semicolon delimiter to separate the values.

	A	B	C	D	E
1	Start date:	11/6/2014	Start time	31:21.6	
2	Sample interval:	0.59			
3	Reading #	Reading			
4	1	2.12E-05			
5	2	-1.36E-03			
6	3	-2.04E-05			
7	4	-1.99E-05			
8	5	6.53E-06			
9	6	-1.35E-05			
10	7	-1.32E-04			
11	8	-2.32E-05			
12	9	-2.23E-05			
13	10	-2.34E-05			
14	11	-6.93E-06			
15	12	-3.31E-05			
16	13	-1.35E-05			
17	14	-1.07E-05			
18	15	-2.99E-05			
19	16	-1.09E-05			
20	17	3.33E-04			
21	18	-6.88E-05			
22	19	1.19E-05			
23	20	-2.68E-05			

When **Metadata** is off, only the reading data is saved:

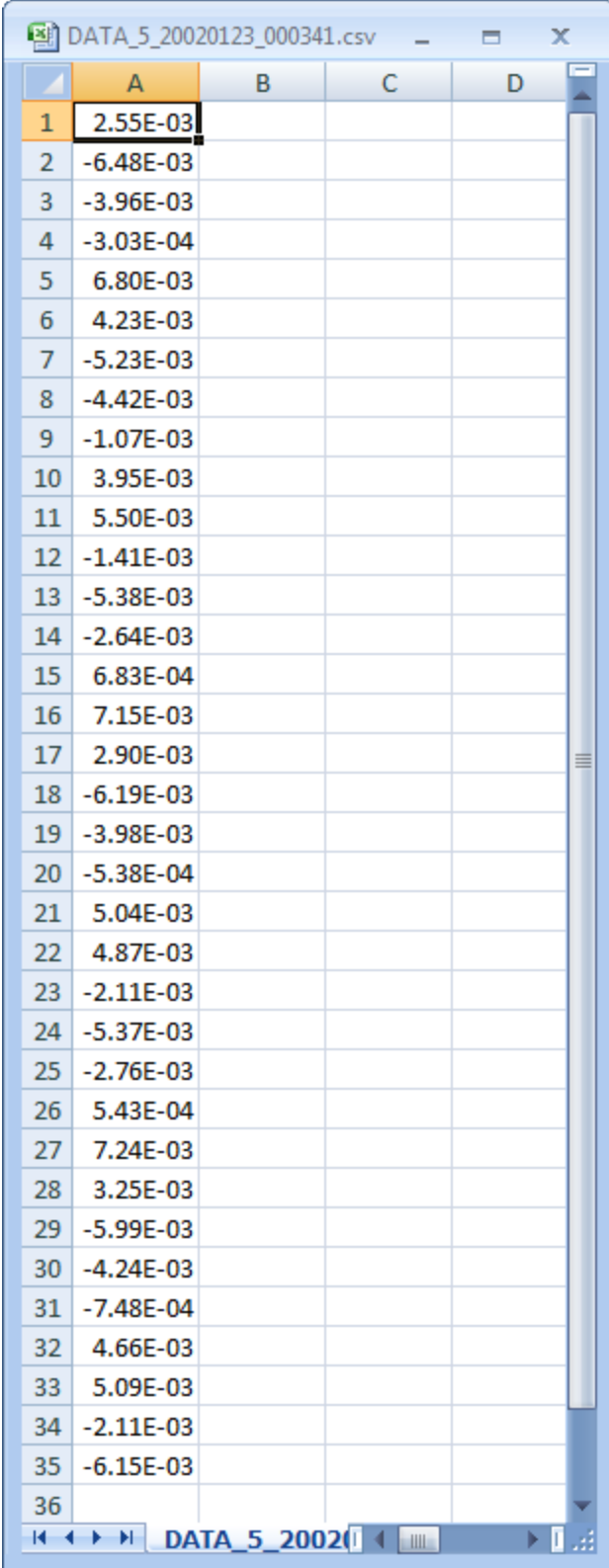

The image shows a spreadsheet window titled "DATA_5_20020123_000341.csv". The spreadsheet has four columns labeled A, B, C, and D. Column A contains 35 rows of data, with the first row (row 1) highlighted in orange. The values in column A are as follows:

Row	Value
1	2.55E-03
2	-6.48E-03
3	-3.96E-03
4	-3.03E-04
5	6.80E-03
6	4.23E-03
7	-5.23E-03
8	-4.42E-03
9	-1.07E-03
10	3.95E-03
11	5.50E-03
12	-1.41E-03
13	-5.38E-03
14	-2.64E-03
15	6.83E-04
16	7.15E-03
17	2.90E-03
18	-6.19E-03
19	-3.98E-03
20	-5.38E-04
21	5.04E-03
22	4.87E-03
23	-2.11E-03
24	-5.37E-03
25	-2.76E-03
26	5.43E-04
27	7.24E-03
28	3.25E-03
29	-5.99E-03
30	-4.24E-03
31	-7.48E-04
32	4.66E-03
33	5.09E-03
34	-2.11E-03
35	-6.15E-03
36	

Data Logging and the Trend Chart Display

- When data logging to memory, the trend chart maps each reading to a dot in a pixel column, draws a line between multiple dots in each column, and draws a line from the last reading in a column to the first reading in the next column.
- When data logging to a file, if the instrument determines the readings will fit in memory, the trend chart behaves as it does when data logging to memory. If there are too many readings to save in memory, the trend chart behaves in a manner similar to that of the continuous measurement mode. That is, the number of readings shown per pixel column depends on the reading rate and the selected Time Window.

Data Log and Digitizing Local Remote Interaction

CAUTION

Loss of data possible - local to remote transition clears instrument memory: When data logging or digitizing *to memory*, if you access the instrument from remote (send a SCPI or common command)* and then return to local (by pressing [**Local**]), the readings in memory are cleared and the instrument returns to Continuous mode.

For data logging only, you can prevent this situation by data logging to a file instead of to memory (see [Data Log Mode](#) for details). You can also prevent this from happening for data logging or digitizing by taking steps to keep the instrument from being accessed from remote. To prevent remote access, you may want to disconnect the LAN, GPIB, and USB interface cables from the instrument before starting the measurements. To prevent remote access via LAN, you can connect the instrument behind a router to minimize the possibility of remote access. You can also disable the various I/O interfaces from the front panel menus under [**Utility**] > **I/O Config**.

To view the status of a data logging or digitizing operation remotely, use the instrument's [Web User Interface](#). The Web User Interface monitor does not set the instrument to remote.

**When accessed from remote, the instrument will continue data logging or digitizing to completion, and you can retrieve the readings from remote.*

Level Triggering

Level triggering is available only on the 34465A/70A with the DIG option. Level triggering allows you to trigger measurements at some defined point on the input signal, such as when the signal crosses zero volts or when it reaches the midpoint of its positive or negative peak amplitude. For example, this graphic shows sampling beginning as the input signal crosses 0V with a positive slope:

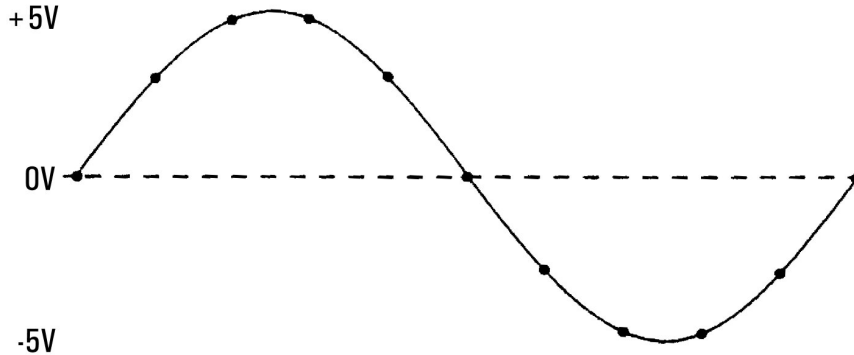

About Level Trigger

Level triggering is available for these measurement functions:

- DC voltage and DC current
- AC voltage and AC current
- 2-wire and 4-wire resistance with offset compensation off, and low power off
- Temperature, RTD or thermistor sensors only
- Frequency and period

The level trigger is edge-sensitive. That is, the instrument must detect a *change* in the quantity being measured from one side of the level setting to the other side (direction controlled by Slope setting). For example, if the Slope is positive, then the quantity being measured must first reach a value *below* the set level before a trigger event can be detected.

Level trigger performance is not uniform. Its accuracy, latency, and sensitivity are dependent on other DMM features. These dependencies vary by measurement function as described below.

DC voltage, DC current, and 2-wire resistance considerations

These measurement functions can use a fast-response detector built into the hardware for fixed-range measurements. For lowest latency and highest sensitivity, use a fixed range when using level trigger. However, trigger level accuracy is reduced when the hardware detector is used.

To increase trigger level accuracy and reduce sensitivity (avoid false triggers due to noise), use autorange:

- When auto-range is enabled, trigger level accuracy is increased, latency is increased, and sensitivity is decreased as the aperture or NPLC setting is increased.
- When auto-range is enabled, trigger level accuracy is increased, latency is increased, and sensitivity is decreased if autozero is enabled.
- When auto-range is enabled, range changes may be made while waiting for the trigger crossing which can cause additional latency/uncertainty.

4-wire resistance and temperature considerations

- Trigger level accuracy is increased, latency is increased, and sensitivity is decreased as aperture or NPLC is increased.
- Fixed range (only available for resistance) eliminates uncertainties (due to range change) in trigger latency.

AC voltage and AC current considerations

- Trigger latency is increased, and sensitivity is decreased as filter bandwidth is increased.
- Trigger latency can be controlled by trigger delay setting.
- Fixed range eliminates uncertainties (due to range change) in trigger latency.
- Autorange uncertainties become worse as filter bandwidth is increased.

Frequency and period considerations

- Trigger level accuracy is increased, latency is increased, and sensitivity is decreased as gate time is increased.
- Fixed voltage range eliminates uncertainties (due to range change) in trigger latency.

Other Sources of Measurement Error

Settling Time Effects

The multimeter can insert automatic measurement settling delays. These delays are adequate for resistance measurements with less than 200 pF of combined cable and device capacitance. This is particularly important when measuring resistances above 100 kΩ. Settling due to RC time constant effects can be quite long. Some precision resistors and multi-function calibrators use large parallel capacitors (1000 pF to 0.1 μF) with high resistor values to filter out noise currents injected by their internal circuitry. Non-ideal capacitances in cables and other devices may have much longer settling times than expected just by RC time constants due to dielectric absorption (soak) effects. Errors are measured when settling after the initial connection and after a range change.

Loading Errors (AC volts)

In the AC voltage function, the input of the multimeter appears as a 1 MΩ resistance in parallel with 100 pF of capacitance. The cabling that you use to connect signals to the multimeter also adds capacitance and loading. The table below shows the multimeter's approximate input resistance at various frequencies.

Input Frequency	Input Resistance (kΩ)
100 Hz	941
1 kHz	614
10 kHz	137
100 kHz	15.7

For low frequencies, the loading error is:

$$\text{Error (\%)} = \frac{-100 \times R_s}{R_s + 1 \text{ M}\Omega}$$

At high frequencies, the additional loading error is:

$$\text{Error (\%)} = 100 \times \left[\frac{1}{\sqrt{1 + (2 \pi \times F \times R_s \times C_{in})^2}} - 1 \right]$$

R_s = source resistance

F = input frequency

C_{in} = input capacitance (100 pF) plus cable capacitance

Measurements Below Full Scale

You can make the most accurate AC measurements when the multimeter is at or near the full scale of the selected range. Autoranging occurs at 10% (down-range) and 120% (up-range) of full scale. This enables you to measure some inputs at full scale on one range and 10% of full scale on the next higher range. In general, the accuracy is better on the lower range; for the highest accuracy, select the lowest manual range possible for the measurement.

High-Voltage Self-Heating Errors

If you apply more than 300 Vrms, self-heating occurs in the multimeter's internal signal-conditioning components. These errors are included in the multimeter's specifications. Temperature changes inside the multimeter due to self-heating may cause additional error on other AC voltage ranges. The additional error is less than 0.02% and dissipates in a few minutes.

AC Current Measurement Errors (Burden Voltage)

Burden voltage errors, which apply to DC current, also apply to AC current measurements. However, the burden voltage for AC current is larger due to the multimeter's series inductance and your measurement connections. The burden voltage increases as the input frequency increases. Some circuits may oscillate when performing current measurements due to the multimeter's series inductance and your measurement connections.

Low-Level Measurement Errors

AC voltage measurements less than 100 mV are especially susceptible to errors introduced by extraneous noise sources. An exposed test lead acts as an antenna and a properly functioning DMM will measure the signals received. The entire measurement path, including the power line, act as a loop antenna. Circulating currents in the loop create error voltages across any impedances in series with the DMM's input. Therefore, you should apply low-level AC voltages to the DMM through shielded cables, with the shield connected to the input LO terminal.

Connect the DMM and the AC source to the same electrical outlet whenever possible. You should also minimize the area of any ground loops that cannot be avoided. A high-impedance source is more susceptible to noise pickup than a low-impedance source. You can reduce the high-frequency impedance of a source by placing a capacitor in parallel with the DMM's input terminals. You may have to experiment to determine the correct capacitor for your application.

Most extraneous noise is not correlated with the input signal. You can determine the error as shown below.

$$\text{Voltage Measured} = \sqrt{V_{\text{in}}^2 + \text{Noise}^2}$$

Correlated noise, while rare, is especially detrimental because it always adds directly to the input signal. Measuring a low-level signal with the same frequency as the local power line is a common situation that is prone to this error.

Common Mode Errors

Errors are generated when the multimeter's input LO terminal is driven with an AC voltage relative to earth. The most common situation where unnecessary common mode voltages are created is when the output of an AC calibrator is connected to the multimeter "backwards." Ideally, a multimeter reads the same regardless of how the source is connected. Both source and multimeter effects can degrade this ideal situation. Because of the capacitance between the input LO terminal and earth (approximately 200 pF), the source will experience different loading depending on how the input is applied. The magnitude of the error is dependent upon the source's response to this loading.

The DMM's measurement circuitry, while extensively shielded, responds differently in the backward input case due to slight differences in stray capacitance to earth. The DMM's errors are greatest for high-voltage, high-frequency inputs. Typically, the DMM exhibits about 0.06% additional error for a 100 V, 100 kHz reverse input. You can use the grounding techniques described for DC common mode problems to minimize AC common mode voltages.

Leakage Current Errors

The DMM's input capacitance will "charge up" due to input bias currents when the terminals are open-circuited (if the input resistance is $> 10 \text{ G}\Omega$). The DMM's measuring circuitry exhibits approximately 30 pA of input bias current for ambient temperatures from 0 to $30 \text{ }^\circ\text{C}$. Bias current doubles for every $8 \text{ }^\circ\text{C}$ change in ambient temperature above $30 \text{ }^\circ\text{C}$. This current generates small voltage offsets dependent upon the source resistance of the DUT. This effect becomes evident for a source resistance of greater than $100 \text{ k}\Omega$, or when the DMM's operating temperature is significantly greater than $30 \text{ }^\circ\text{C}$.

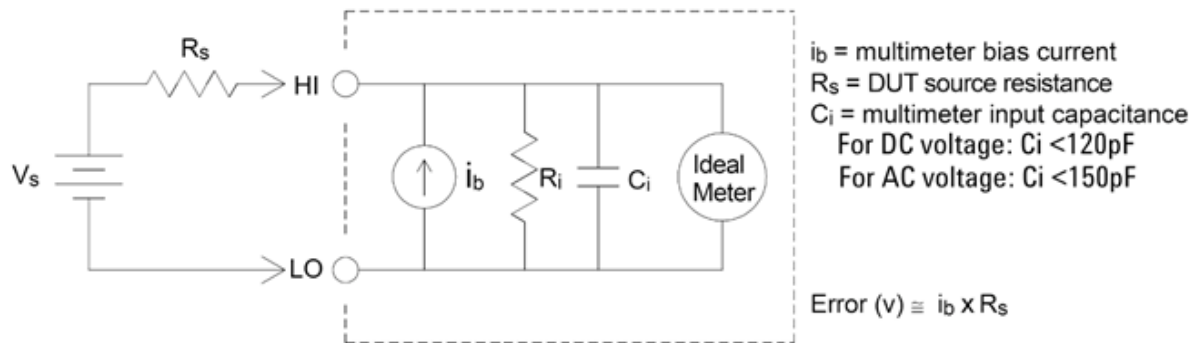

Unnecessary Signal Errors

Both 3A and 10A terminals are available for AC and DC current measurements. If signals are applied to terminals not being used for the current measurement, measurement errors may occur. The unused terminals are protected but the additional signals may interfere with current measurements. For example, applying inputs to the 3A terminals while making measurements on the 10A terminals will typically cause errors.

Unnecessary signals applied to the Hi and Lo Sense terminals can also cause errors. AC or DC voltages above 15 volts peak on the sense terminals are likely to cause measurement errors.

How Sample Rate/Interval is Determined

The DMM always attempts to make the sample interval greater than the expected time required to take the measurements, whether in continuous, data log, or digitize mode. A number of settings go into the calculation of the minimum allowable sample interval. These settings include the measurement function, NPLC, aperture, autorange, autozero, offset compensation, AC filter, TC open check and gate time. For example, when autorange is on, the assumption is that no more than one range change will be required. If more than one level of change occurs, the measurement may be delayed and an error will be issued.

When you change any of these settings, the sample interval (sample timer in continuous mode, sample interval in data log or digitize mode) is increased to be greater than the calculated measurement time. In the continuous and data log modes, attempting to reduce the sample interval below the calculated value results in an error message. You must then choose among the various ways you can achieve a smaller measurement time to achieve the smaller sample interval, such as decreasing the NPLC setting. For digitizing, the emphasis is on high sample rates and all settings except aperture/NPLC are fixed to achieve minimum measurement time. NPLC and aperture are automatically set to their minimum values upon entering digitize mode. If you set NPLC or aperture to greater values, the sample interval will be increased (or the sample rate decreased) to accommodate the longer measurement. However, in digitize mode, unlike continuous and data log modes, if you subsequently decrease the sample interval (or increase the sample rate), the NPLC or aperture will be reduced as needed.

Another way to put it is that for continuous and data log modes, sample timer/interval is always controlled by the other measurement settings. In digitize mode, the sample timer/interval, NPLC, and aperture have equal control; changing any one setting can change the other settings.

SCPI Programming Reference

This section contains information to help you program the Keysight Truevolt Series digital multimeters over a remote interface using the SCPI programming language.

[Introduction to the SCPI Language](#)

[Commands by Subsystem](#)

[Command Quick Reference](#)

[SCPI Error Messages](#)

[Power-On and Reset State](#)

Related Information

IO Libraries and Instrument Drivers

The Keysight IO Libraries Suite software and installation instructions are on the *Keysight Automation Ready CD-ROM* provided with your instrument (optional for 34460A).

Keysight Truevolt Series Documentation

The latest product documentation is available at www.keysight.com/find/truevolt-doc. For documentation for mobile devices, see www.keysight.com/find/truevolt-mobilehelp.

For information about connecting instruments to USB, LAN and GPIB interfaces and how to configure and troubleshoot these interfaces, refer to Keysight IO Libraries help. The Keysight IO Libraries can be downloaded from www.keysight.com/find/iosuite.

Web Interface

The 34461A/65A/70A and the 34460A (with option 34460A-LAN or option 3446LANU) have a Web Interface built into the instrument. You can use this interface over LAN for remote access and control of the instrument via a Web browser. See [Web Interface](#) for details.

Introduction to the SCPI Language

SCPI (Standard Commands for Programmable Instruments) is an ASCII-based programming language for test and measurement instruments. SCPI commands use a hierarchical structure known as a tree system. Associated commands are grouped under a common node or root, thus forming subsystems. A portion of the SENSE subsystem illustrates this, below.

SENSE:

VOLTage:

DC:RANGe {<range>|MIN|MAX|DEF}

DC:RANGe? [MINimum|MAXimum|DEFault]

SENSE is the root keyword of the command, **VOLTage** is a second-level keyword, and **DC** is a third-level keyword. A colon (:) separates consecutive keywords.

Syntax Conventions

The command syntax format is illustrated below:

VOLTage:DC:RANGe {<range>|MIN|MAX|DEF}

Most commands (and some parameters) are a mixture of upper- and lower-case letters. The upper-case letters indicate the command's abbreviated spelling, which yields shorter program lines. For better program readability, use the long form.

For example, consider the keyword VOLTage, above. You can type VOLT or VOLTage in any combination of upper- or lower-case letters. Therefore, VolTaGe, volt and Volt are all acceptable. Other forms, such as VOL and VOLTAG, generate errors.

Braces ({ }) enclose the parameter choices. The braces are not sent with the command string.

A vertical bar (|) separates parameter choices. For example, {<range>|MIN|MAX|DEF} in the above command indicates that you can specify a numeric range parameter, or "MIN", "MAX" or "DEF". The bar is not sent with the command string.

Angle brackets (< >) indicate that you must specify a value for the enclosed parameter. For example, the above syntax statement shows the <range> parameter in angle brackets. Do not send the brackets with the command string. You must specify a value for the parameter (for example "VOLT:DC:RANG 10") unless you select one of the other options shown in the syntax (for example "VOLT:DC:RANG MIN").

Optional parameters are enclosed in square brackets ([]). The brackets are not sent with the command string. If you do not specify a value for an optional parameter, the instrument uses a default value.

Command Separators

A colon (:) separates consecutive keywords. You must insert a blank space to separate a parameter from a command keyword. If a command requires more than one parameter, separate adjacent parameters using a comma:

```
CONF:VOLT:DC 10,0.003
```

A semicolon (;) separates commands within the same subsystem and can also minimize typing. For example, the following string:

```
TRIG:SOUR EXT;COUNT 10
```

is equivalent to the following two commands:

```
TRIG:SOUR EXT
TRIG:COUNT 10
```

Use a colon and a semicolon to link commands from different subsystems. For example, in the following example, an error is generated if you do not use both the colon and semicolon:

```
TRIG:COUN MIN; :SAMP:COUN MIN
```

Using the MIN, MAX and DEF Parameters

For many commands, you can substitute "MIN" or "MAX" in place of a parameter. In some cases you may also substitute "DEF". For example, consider The following example:

```
VOLTage:DC:RANGe {<range>|MIN|MAX|DEF}
```

Instead of selecting a specific value for the <range> parameter, you can substitute MIN to set the range to its minimum value, MAX to set the range to its maximum value or DEF to set the range to its default value.

Querying Parameter Settings

You can query the current value of most parameters by adding a question mark (?) to the command. For example, The following example sets the trigger count to 10 measurements:

```
TRIG:COUN 10
```

You can then query the count value by sending:

```
TRIG:COUN?
```

You can also query the minimum or maximum count allowed as follows:

```
TRIG:COUN? MIN
TRIG:COUN? MAX
```

SCPI Command Terminators

A command string sent to the instrument must terminate with a <new line> (<NL>) character (ASCII decimal 10). The IEEE-488 EOI (End-Or-Identify) message is interpreted as a <NL> character and can be used to terminate a command string in place of a <NL> character. A <carriage return> followed by a <NL> is also accepted. Command string termination always resets the current SCPI command path to the root level.

NOTE

For every SCPI message that includes a query and is sent to the instrument, the instrument terminates the returned response with a <NL> or line-feed character (EOI). For example, if R? is sent, the response is terminated with a <NL> after the block of data that is returned. If a SCPI message includes multiple queries separated by semicolons (for example "ROUTE:TERMinals?;R?"), the returned response is again terminated by a <NL> after the response to the last query. In either case, the program must read this <NL> in the response before another command is sent to the instrument or an error occurs.

IEEE-488.2 Common Commands

The IEEE-488.2 standard defines a set of common commands that perform functions such as reset, self-test and status operations. Common commands always begin with an asterisk (*), are three characters in length and may include one or more parameters. The command keyword is separated from the first parameter by a blank space. Use a semicolon (;) to separate multiple commands as shown below:

```
*RST; *CLS; *ESE 32; *OPC?
```

SCPI Parameter Types

The SCPI language defines several data formats to be used in program messages and response messages.

Numeric Parameters

Commands that require numeric parameters accept all commonly used decimal representations of numbers including optional signs, decimal points, and scientific notation. Special values for numeric parameters such as MIN, MAX and DEF are also accepted. You can also send engineering unit suffixes with numeric parameters (e.g., M, k, m or u). If a command accepts only certain specific values, the instrument rounds the input numeric parameters to the accepted values. The following command requires a numeric parameter for the range value:

```
VOLTage:DC:RANGe {<range>|MIN|MAX|DEF}
```

NOTE

Because the SCPI parser is case-insensitive, there is some confusion over the letter "M" (or "m"). For your convenience, the instrument interprets "mV" (or "MV") as millivolts, but "MHZ" (or "mhz") as megahertz. Likewise "MΩ" (or "mΩ") is interpreted as megΩ. You can use the prefix "MA" for mega. For example, "MAV" is interpreted as megavolts.

Discrete Parameters

Discrete parameters are used to program settings that have a limited number of values (like IMMEDIATE, EXTERNAL or BUS). They have a short form and a long form just like command keywords. You can mix upper- and lower-case letters. Query responses always return the short form in all upper-case letters. The following example requires a discrete parameters for the temperature units:

```
UNIT:TEMPerature {C|F|K}
```

Boolean Parameters

Boolean parameters represent a single binary condition that is either true or false. For a false condition, the instrument accepts "OFF" or "0". For a true condition, the instrument accepts "ON" or "1". When you query a Boolean setting, the instrument returns "0" or "1". The following example requires a Boolean parameter:

```
DISPlay:STATe {ON|1|OFF|0}
```

ASCII String Parameters

String parameters can contain virtually any set of ASCII characters. A string must begin and end with matching quotes; either with a single quote or a double quote. You can include the quote delimiter as part of the string by typing it twice without any characters in between. The following command uses a string parameter:

```
DISPlay:TEXT <quoted string>
```

For example, The following example displays the message "WAITING..." on the instrument's front panel (the quotes are not displayed).

```
DISP:TEXT "WAITING..."
```

You can also display the same message using The following example with single quotes.

```
DISP:TEXT 'WAITING...'
```

Using Device Clear

Device Clear is an IEEE-488 low-level bus message that you can use to return the instrument to a responsive state. Different programming languages and IEEE-488 interface cards provide access to this capability through their own unique commands. The status registers, the error queue, and all configuration states are left unchanged when a Device Clear message is received.

Device Clear performs the following actions:

- If a measurement is in progress, it is aborted.
- The instrument returns to the trigger "idle" state.
- The instrument's input and output buffers are cleared.
- The instrument is prepared to accept a new command string.
- An overlapped command, if any, is terminated with no "Operation Complete" indication (applies to INIT).

NOTE The ABORt command is the recommended method to terminate a measurement.

Commands by Subsystem

[ABORt](#)

[CALCulate:CLEAr\[:IMMEDIATE\]](#)

[CALCulate:AVERAge Subsystem](#)

[CALCulate:LIMit Subsystem](#)

[CALCulate:SCALe Subsystem](#)

[CALCulate:SMOothing Subsystem](#)

[CALCulate:TCHart\[:STATE\]](#)

[CALCulate:TRANSform:HISTogram Subsystem](#)

[CALibration Subsystem](#)

[CONFigure Subsystem](#)

[DATA Subsystem](#)

[DISPlay Subsystem](#)

[FETCH?](#)

[FORMat Subsystem](#)

[HCOPY Subsystem](#)

[IEEE 488.2 Common Commands](#)

[INITiate\[:IMMEDIATE\]](#)

[LXI Subsystem](#)

[MEASure Subsystem](#)

[MMEMory Subsystem - Data Transfer Commands](#)

[MMEMory Subsystem - General Purpose File Management](#)

[MMEMory Subsystem - STATe and PREference Files](#)

[OUTPut:TRIGger:SLOPe](#)

[R?](#)

[READ?](#)

[ROUTe:TERMinals?](#)

[SAMPle Subsystem](#)

[\[SENSe:\]CAPacitance Subsystem](#)

[\[SENSe:\]CURRent Subsystem](#)

[\[SENSe:\]DATA2 Subsystem](#)

[\[SENSe:\]{FREQuency|PERiod} Subsystem](#)

[\[SENSe:\]{RESistance|FRESistance} Subsystem](#)

[\[SENSe:\]TEMPerature Subsystem](#)

[\[SENSe:\]VOLTage Subsystem](#)

[STATus Subsystem](#)

[SYSTEM Subsystem - General Purpose Commands](#)

[SYSTEM Subsystem - I/O Configuration](#)

[SYSTEM:LICense Subsystem](#)

[SYSTEM:LOCK Subsystem](#)

[TEST:ALL?](#)

[TRIGger Subsystem](#)

[UNIT:TEMPerature](#)

ABORt

Aborts a measurement in progress, returning the instrument to the trigger idle state.

Parameter	Typical Return
(none)	(none)
Abort a measurement in progress: ABORt	

- Use this to abort a measurement when the instrument is waiting for a trigger, or for aborting a long measurement or series of measurements.

FETCh?

Waits for measurements to complete and copies all available measurements to the instrument's output buffer. The readings remain in reading memory.

Parameter	Typical Return
(none)	(none)
<p>Use FETCh? with CONFigure and INITiate. The INITiate command places the instrument in the "wait-for-trigger" state, triggers a measurement when the rear-panel Ext Trig input is pulsed (low by default), and sends the measurement to reading memory. The FETCh? query transfers the measurement from reading memory to the instrument's output buffer.</p> <p>CONF:VOLT:DC 10,0.003 TRIG:SOUR EXT SAMP:COUN 4 INIT FETC?</p> <p>Typical Response: -4.98748741E-01,-4.35163427E-01,-4.33118686E-01,-3.48109378E-01</p>	

- The FETCh? query does not erase measurements from the reading memory. You can send the query multiple times to retrieve the same data.
- You can store up to 1,000 measurements in the reading memory of the 34460A, 10,000 measurements on the 34461A, 50,000 measurements on the 34465A/70A (*without* the MEM option), or 2,000,000 measurements on the 34465A/70A (*with* the MEM option). If reading memory overflows, new measurements overwrite the oldest measurements stored; the most recent measurements are always preserved. No error is generated, but the Reading Mem Ovfl bit (bit 14) is set in the Questionable Data Register's condition register (see [Status System Introduction](#)).
- The instrument clears all measurements from reading memory when the measurement configuration changes, or when any of these commands are executed: [INITiate](#), [MEASure:<function>?](#), [READ?](#), [*RST](#), [SYSTEM:PRESet](#).

INITiate[:IMMEDIATE]

Changes the state of the triggering system from "idle" to "wait-for-trigger", and clears the previous set of measurements from reading memory. Measurements begin when the specified trigger conditions are satisfied following the receipt of [INITiate](#).

Parameter	Typical Return
(none)	(none)
Return five DC voltage measurements, using a software trigger to start the measurements: CONF:VOLT:DC 10,0.003 TRIG:SOUR BUS SAMP:COUN 5 INIT *TRG FETC?	

- Storing measurements in reading memory with [INITiate](#) is faster than sending measurements to the instrument's output buffer using [READ?](#) (provided you do not send [FETCh?](#) until done). The [INITiate](#) command is also an "overlapped" command. This means that after executing [INITiate](#), you can send other commands that do not affect the measurements.
- You can store up to 1,000 measurements in the reading memory of the 34460A, 10,000 measurements on the 34461A, 50,000 measurements on the 34465A/70A (*without* the MEM option), or 2,000,000 measurements on the 34465A/70A (*with* the MEM option). If reading memory overflows, new measurements overwrite the oldest measurements stored; the most recent measurements are always preserved. No error is generated, but the Reading Mem Ovfl bit (bit 14) is set in the Questionable Data Register's condition register (see [Status System Introduction](#)).
- To retrieve the measurements from the reading memory, use [FETCh?](#). Use [DATA:REMove?](#) or [R?](#) to read and erase all or part of the available measurements.
- Use [ABORt](#) to return to idle.

OUTPut:TRIGger:SLOPe {POSitive|NEGative}
 OUTPut:TRIGger:SLOPe?

Selects the slope of the *voltmeter complete* output signal on the rear-panel **VM Comp** BNC connector.

Parameter	Typical Return
{POSitive NEGative}. Default: NEG	POS or NEG
Configure DC voltage measurements and make two measurements. The signal on the rear-panel VM Comp connector outputs a positive pulse as each measurement is completed: CONF:VOLT:DC 10 SAMP:COUN 2 OUTP:TRIG:SLOP POS INIT	

- On the 34460A, this requires option 34460A-LAN or option 3446LANU.
- This parameter is set to its default value after a Factory Reset (***RST**) or Instrument Preset (**SYSTEM:PRESet**).

R? [*<max_readings>*]

Reads and erases all measurements from reading memory up to the specified *<max_readings>*. The measurements are read and erased from the reading memory starting with the oldest measurement first.

Parameter	Typical Return
1 to 2,000,000 (readings) Default is all readings in memory.	(none)
Read and remove the three oldest readings: R? 3 Typical Response: #247-4.98748741E-01,-4.35163427E-01,-7.41859188E-01 The "#2" means that the next 2 digits indicate how many characters are in the returned memory string. These two digits are the "47" after the "#2". Therefore, the remainder of the string is 47 digits long: -4.98748741E-01,-4.35163427E-01,-7.41859188E-01	

- The [R?](#) and [DATA:REMove?](#) queries can be used during a long series of readings to periodically remove readings from memory that would normally cause the reading memory to overflow. [R?](#) does not wait for all readings to complete. It sends the readings that are complete at the time the instrument receives the command. Use [Read?](#) or [Fetch?](#) if you want the instrument to wait until all readings are complete before sending readings.
- If you do not specify a value for *<max_readings>*, all measurements are read and erased.
- No error is generated if the reading memory contains less readings than requested. In this case, all available readings in memory are read and deleted.
- The number of readings returned may be less than that requested depending on the amount of reading memory in your instrument. You can store up to 1,000 measurements in the reading memory of the 34460A, 10,000 measurements on the 34461A, 50,000 measurements on the 34465A/70A (*without* the MEM option), or 2,000,000 measurements on the 34465A/70A (*with* the MEM option). If reading memory overflows, new measurements overwrite the oldest measurements stored; the most recent measurements are always preserved. No error is generated, but the Reading Mem Ovfl bit (bit 14) is set in the Questionable Data Register's condition register (see [Status System Introduction](#)).
- The instrument clears all measurements from reading memory when the measurement configuration changes, or when any of these commands are executed: [INITiate](#), [MEASure:<function>?](#), [READ?](#), [*RST](#), [SYSTem:PRESet](#).

READ?

Starts a new set of measurements, waits for all measurements to complete, and transfers all available measurements. Sending READ? is similar to sending [INITiate](#) followed immediately by [FETCh?](#).

Parameter	Typical Return
(none)	(none)
Transfer measurements from reading memory:	
READ?	
Typical Response: -4.98748741E-01,-4.35163427E-01,-4.33118686E-01,-3.48109378E-01	

- The [FETCh?](#) query does not erase measurements from the reading memory. You can send the query multiple times to retrieve the same data.
- You can store up to 1,000 measurements in the reading memory of the 34460A, 10,000 measurements on the 34461A, 50,000 measurements on the 34465A/70A (*without* the MEM option), or 2,000,000 measurements on the 34465A/70A (*with* the MEM option). If reading memory overflows, new measurements overwrite the oldest measurements stored; the most recent measurements are always preserved. No error is generated, but the Reading Mem Ovfl bit (bit 14) is set in the Questionable Data Register's condition register (see [Status System Introduction](#)).
- The instrument clears all measurements from reading memory when the measurement configuration changes, or when any of these commands are executed: [INITiate](#), [MEASure:<function>?](#), [READ?](#), [*RST](#), [SYSTem:PRESet](#).

ROUTe:TERMinals?

Indicates which input terminals are selected on the 34461A front panel **Front/Rear** switch. This switch is not programmable; this query reports the position of the switch, but cannot change it.

WARNING Do not toggle the Front/Rear switch with active signals on the terminals. This switch is not intended to be used in this way and may be damaged by high voltages or currents, possibly compromising the instrument's safety features.

Parameter	Typical Return
(none)	FRON or REAR
Return the state of the Front/Rear switch: ROUT:TERM?	

- On the 34460A, this query always returns FRON.

TEST:ALL?

Runs an instrument self-test and returns a pass/fail indication. The [TEST:ALL?](#) self-test is more comprehensive than the [*TST?](#) self-test.

CAUTION You must remove all input connections to the instrument before running the full self-test.

Parameter	Typical Return
(none)	(none)
Run a self-test:	
TEST:ALL?	
Typical Response: +0 (pass) or +1 (one or more tests failed)	

- If one or more tests fail, the query returns +1 and stores an error in the error queue. For a complete listing of the error messages related to self-test failures, see [Self-test Error Messages](#).
- Following the test, the instrument returns to the instrument state that existed before the self-test.

UNIT:TEMPerature {C|F|K}
 UNIT:TEMPerature?

Selects the units (°C, °F or Kelvin) to be used for all temperature measurements except the [SYSTem:TEMPerature?](#) query.

Parameter	Typical Return
{C F K}. Default: C.	C, F, or K
Make a four-wire RTD measurement and return the result in °F: UNIT:TEMP F MEAS:TEMP? FRTD Typical Response: +6.82320000E+01	

- The command also accepts CEL or FAR, but the query returns C or F.
- This parameter is set to its default value after a Factory Reset ([*RST](#)) or Instrument Preset ([SYSTem:PRESet](#)).

See Also

[CONFigure:TEMPerature](#)

[MEASure:TEMPerature?](#)

[\[SENSe:\]FUNCTion\[:ON\]](#)

CALCulate Subsystem Introduction

The CALCulate subsystem receives real-time data from the measurement hardware and sends them to reading memory. It also optionally performs the following math operations, as shown in the diagram below:

- Smoothing
- Scaling
- Statistics
- Limit checking
- Histogram

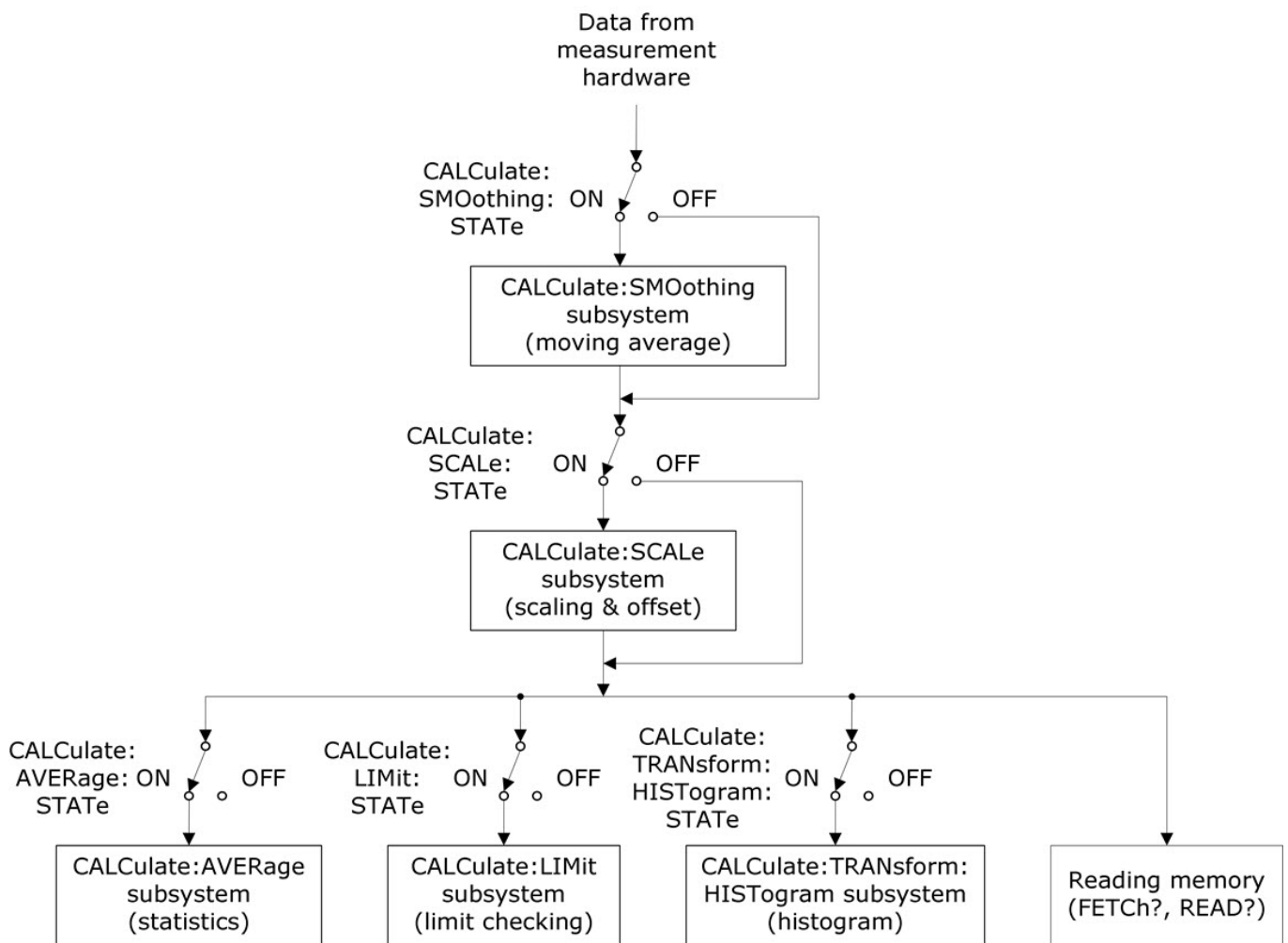

Only calculations enabled by `CALC:SCAL:STAT`, `CALC:TRAN:HIST:STAT`, `CALC:LIM:STAT`, and `CALC:AVER:STAT` are performed.

Parts of the CALCulate Subsystem

[CALCulate:CLear\[:IMMEdiate\]](#)

[AVERAge Subsystem](#)

[HISTogram Subsystem](#)

[LIMit Subsystem](#)

[SCALing Subsystem](#)

[SMOothing Subsystem](#)

CALCulate:CLEar[:IMMEDIATE]

Clears all limits, histogram data, statistics, and measurements.

Parameter	Typical Return
(none)	(none)
Clear all limits, histogram data, statistics, and measurements: CALC:CLE:IMM	

- Items are cleared synchronously; histogram, statistics, and limit data all restart at the same time that measurements restart.

CALCulate:LIMit Subsystem

This subsystem specifies measurements and indicates when a limit has been exceeded.

Example

The following example enables limit testing of 100 DC voltage measurements and indicates whether measurements were outside the range of 3.2 to 3.4 V. Measurements above 3.4 V set bit 12 (Upper Limit Failed) of the Questionable Status Register; measurements below 3.2 V set bit 11 (Lower Limit Failed).

```
*CLS
STAT:PRES
CONF:VOLT 10,.001
SAMP:COUN 100
CALC:LIM:LOW 3.2
CALC:LIM:UPP 3.4
CALC:LIM:STAT ON
INIT
*WAI
STAT:QUES?
```

Typical Response: +4096 (at least one measurement was above the upper limit)

Command Summary

[CALCulate:LIMit:CLEar\[:IMMediate\]](#)

[CALCulate:LIMit:{LOWer|UPPer}\[:DATA\]](#)

[CALCulate:LIMit\[:STATe\]](#)

CALCulate:LIMit:CLEar[:IMMEDIATE]

Clears front panel indications of limits being exceeded and clears bit 11 ("Lower Limit Failed") and bit 12 ("Upper Limit Failed") in the Condition Register of the Questionable Data Register event register group. The corresponding event register bits are unaffected.

A condition register continuously monitors the state of the instrument. Condition register bits are updated in real time; they are neither latched nor buffered.

An event register is a read-only register that latches events from the condition register. While an event bit is set, subsequent events corresponding to that bit are ignored.

Parameter	Typical Return
(none)	(none)
Clear the limit test results:	
CALC:LIM:CLE	

- Does not clear measurements in reading memory.
- The instrument clears front panel indications of limits being exceeded and clears bits 11 and 12 in the Questionable Data Register when the measurement function changes, or when any of the following commands is executed:

CALCulate:LIMit:STATe ON

INITiate

MEASure:<function>?

READ?

CALCulate:LIMit:CLEar

*RST

SYSTem:PRESet

- To clear statistics, limits, histogram data, and measurement data, use CALCulate:CLEar[:IMMEDIATE].

CALCulate:LIMit:{LOWer|UPPer}[:DATA] {<value>|MIN|MAX|DEF}
CALCulate:LIMit:{LOWer|UPPer}[:DATA]? [{MIN|MAX|DEF}]

Sets an upper or lower limit.

Parameter	Typical Return
-1.0E+15 to -1.0E-15, or 0.0 (default) or +1.0E-15 to 1.0E+15	+1.00000000E+00
See Example .	

- You can assign a lower limit, an upper limit or both. Do not set the lower limit above the upper limit.
- *Limit crossing*: If a measurement is less than the specified lower limit, bit 11 ("Lower Limit Failed") is set in the Questionable Data Condition Register. A measurement greater than the specified upper limit sets bit 12 ("Upper Limit Failed"). See [STATus Subsystem Introduction](#) for further information.
- [CONFigure](#) resets both limits to 0.
- This parameter is set to its default value after a Factory Reset ([*RST](#)) or Instrument Preset ([SYSTEM:PRESet](#)).

CALCulate:LIMit[:STATe] {ON|1|OFF|0}

CALCulate:LIMit[:STATe]?

Enables or disables limit testing.

Parameter	Typical Return
{ON 1 OFF 0}. Default: OFF.	0 (OFF) or 1 (ON)
See Example .	

- The instrument clears front panel indications of limits being exceeded and clears bits 11 and 12 in the Questionable Data Register when the measurement function changes, or when any of the following commands is executed:

[CALCulate:LIMit:STATe ON](#)

[INITiate](#)

[MEASure:<function>?](#)

[READ?](#)

[CALCulate:LIMit:CLEar](#)

[*RST](#)

[SYSTem:PRESet](#)

- The instrument turns this setting OFF when the measurement function is changed or after [*RST](#) or [SYSTem:PRESet](#).

CALCulate:TRANSform:HISTogram Subsystem

The HISTogram subsystem configures the histogram display. The instrument clears histogram data when the measurement function changes and when any of the following commands are sent:

CALCulate:TRANSform:HISTogram:CLEar[:IMMEDIATE]

CALCulate:TRANSform:HISTogram:POINTs

CALCulate:TRANSform:HISTogram:RANGE:AUTO

CALCulate:TRANSform:HISTogram:RANGE:{LOWer|UPPer}

CALCulate:TRANSform:HISTogram[:STATe]

INITiate[:IMMEDIATE]

MEASure: <function>?

READ?

*RST

SYSTEM:PRESet

Command Summary

CALCulate:TRANSform:HISTogram:ALL?

CALCulate:TRANSform:HISTogram:CLEar[:IMMEDIATE]

CALCulate:TRANSform:HISTogram:COUNt?

CALCulate:TRANSform:HISTogram:DATA?

CALCulate:TRANSform:HISTogram:POINTs

CALCulate:TRANSform:HISTogram:RANGE:AUTO

CALCulate:TRANSform:HISTogram:RANGE:{LOWer|UPPer}

CALCulate:TRANSform:HISTogram[:STATe]

Example

This example enables an automatically scaled, 100-bin histogram of 1000 DCV measurements. It then returns the computed histogram, including the lower and upper range values, the total measurement count, and the bin data.

```
CONF:VOLT:DC 10,0.001
SAMP:COUN 1000
CALC:TRAN:HIST:RANG:AUTO ON
CALC:TRAN:HIST:POIN 100
CALC:TRAN:HIST:STAT ON
INIT
*WAI
CALC:TRAN:HIST:ALL?
```

Typical Response: +9.99383828E+00,+1.00513398E+01,+1000,<102 bin counts>

NOTE The above response indicates 102 bin counts because the histogram includes bins for values below and above the histogram range.

CALCulate:TRANSform:HISTogram:ALL?
CALCulate:TRANSform:HISTogram:DATA?

The ALL form of the query returns a comma-separated list of the lower and upper range values, the number of measurements, and the bin data collected since the last time the histogram data was cleared. The DATA form returns only the bin data.

Parameter	Typical Return
(none)	See Example .
See Example .	

- The bin data includes the following, in order:
 - The number of measurements less than the lower range value
 - The number of measurements in the each of the bins, starting at the lower range value bin
 - The number of measurements greater than the upper range value
- Range values are real numbers returned in the form +1.00000000E+00. The number of measurements and bin data are signed, positive integers returned in the form +100.

CALCulate:TRANSform:HISTogram:CLEar[:IMMEDIATE]

Clears the histogram data and restarts histogram ranging if it is enabled ([CALCulate:TRANSform:HISTogram:RANGe:AUTO ON](#)).

Parameter	Typical Return
(none)	(none)
Clear the histogram data:	
CALC:TRAN:HIST:CLE	

- Does not clear measurements in reading memory.
- To clear statistics, limits, histogram data, and measurement data, use [CALCulate:CLEar\[:IMMEDIATE\]](#).

CALCulate:TRANSform:HISTogram:COUNT?

Returns the number of measurements collected since the last time the histogram was cleared.

Parameter	Typical Return
(none)	+87
Return the number of measurements used to compute the current histogram:	
CALC:TRAN:HIST:COUN?	

CALCulate:TRANSform:HISTogram:POINTS {<value>|MIN|MAX|DEF}

CALCulate:TRANSform:HISTogram:POINTS? [{MIN|MAX|DEF}]

Sets the number of bins between the lower and upper range values for the histogram. Two additional bins always exist: one for measurements below the lower range and one for measurements above the upper range.

Parameter	Typical Return
{10 20 40 100 200 400 MIN MAX DEF}. Default: 100.	+100
See Example .	

- You can specify the lower and upper range values using [CALCulate:TRANSform:HISTogram:RANGe:{LOWer|UPPer}](#). Lower and upper range values are computed automatically if [CALCulate:TRANSform:HISTogram:RANGe:AUTO](#) is ON.
- This parameter is set to its default value after a Factory Reset ([*RST](#)) or Instrument Preset ([SYSTEM:PRESet](#)).

CALCulate:TRANSform:HISTogram:RANGe:AUTO {ON|1|OFF|0}
CALCulate:TRANSform:HISTogram:RANGe:AUTO?

Enables or disables automatic selection of the histogram's lower and upper range values.

Parameter	Typical Return
{ON 1 OFF 0}. Default: ON.	0 (OFF) or 1 (ON)
See Example .	

- **ON**: the instrument uses the first 1,000 measurements to set the lower and upper range values.
- **OFF**: the lower and upper range values are specified by [CALCulate:TRANSform:HISTogram:RANGe:{LOWer|UPPer}](#).
- Setting the lower or upper range value ([CALCulate:TRANSform:HISTogram:RANGe:{LOWer|UPPer}](#)) disables automatic selection of the lower and upper range values ([CALCulate:TRANSform:HISTogram:RANGe:AUTO OFF](#)).
- The instrument restarts automatic range value selection (if enabled) when [INITiate](#), [MEASure?](#) or [READ?](#) is executed.
- This parameter is set to its default value after a Factory Reset ([*RST](#)) or Instrument Preset ([SYSTEM:PRESet](#)).

CALCulate:TRANSform:HISTogram:RANGe:{LOWer|UPPer} {<value>|MIN|MAX|DEF}
CALCulate:TRANSform:HISTogram:RANGe:{LOWer|UPPer}? [{MIN|MAX|DEF}]

Sets the histogram's lower and upper range values. Setting the lower or upper range value ([CALCulate:TRANSform:HISTogram:RANGe:{LOWer|UPPer}](#)) disables automatic selection of the lower and upper range values ([CALCulate:TRANSform:HISTogram:RANGe:AUTO OFF](#)).

Parameter	Typical Return
-1.0E+15 to -1.0E-15, or 0.0 (default) or +1.0E-15 to 1.0E+15	+1.00000000E+06
See Example .	

- If automatic range value selection is enabled ([CALCulate:TRANSform:HISTogram:RANGe:AUTO ON](#)), the query returns the computed range value. If no histogram data exists, 9.91E37 (Not a Number) is returned.
- Lower and upper range values are computed automatically if [CALCulate:TRANSform:HISTogram:RANGe:AUTO](#) is ON.
- This parameter is set to its default value after a Factory Reset ([*RST](#)) or Instrument Preset ([SYSTEM:PRESet](#)).

CALCulate:TRANSform:HISTogram[:STATe] {ON|1|OFF|0}
CALCulate:TRANSform:HISTogram[:STATe]?

Enables or disables histogram computation.

Parameter	Typical Return
{ON 1 OFF 0}. Default: OFF.	0 (OFF) or 1 (ON)
See Example .	

- The instrument turns this setting OFF when the measurement function is changed or after [*RST](#) or [SYSTEM:PRESet](#).

CALCulate:SCALe Subsystem

This subsystem controls math scaling.

Command Summary

[CALCulate:SCALe:DB:REFerence](#)

[CALCulate:SCALe:DBM:REFerence](#)

[CALCulate:SCALe:FUNCTion](#)

[CALCulate:SCALe:GAIN](#)

[CALCulate:SCALe:OFFSet](#)

[CALCulate:SCALe:REFerence](#)

[CALCulate:SCALe:REFerence:AUTO](#)

[CALCulate:SCALe\[:STATe\]](#)

[CALCulate:SCALe:UNIT](#)

[CALCulate:SCALe:UNIT:STATe](#)

CALCulate:SCALe:DB:REFerence {<reference>|MIN|MAX|DEF}

CALCulate:SCALe:DB:REFerence? [{MIN|MAX|DEF}]

Stores a relative value in the multimeter's dB Relative Register, which is used for the dB function in [CALCulate:SCALe:FUNCTion](#). When the dB function is enabled, this value is subtracted from each voltage measurement after the measurement is converted to dBm.

Parameter	Typical Return
-200.0 dBm to +200.0 dBm. Default: 0.	+3.000000000E+02
Enable dB scaling with a -10 dB reference and a 300 Ω dBm reference resistance:	
CALC:SCAL:DBM:REF 300	
CALC:SCAL:DB:REF -10.0	
CALC:SCAL:FUNC DB	
CALC:SCAL:STAT ON	

- Specifying a reference value disables automatic reference selection ([CALCulate:SCALe:REFerence:AUTO OFF](#)).
- The dB relative value parameter is relative to the dBm reference resistance set with [CALCulate:SCALe:DBM:REFerence](#).
- The instrument sets the reference value to 0.0 with automatic reference selection enabled after a Factory Reset (***RST**), an Instrument Preset ([SYSTem:PRESet](#)), or a change in measurement function.

CALCulate:SCALE:DBM:REFerence {<reference>|MIN|MAX|DEF}

CALCulate:SCALE:DBM:REFerence? [{MIN|MAX|DEF}]

Selects the reference resistance for converting voltage measurements to dBm. This reference value affects the dBm and dB scaling functions.

Parameter	Typical Return
50, 75, 93, 110, 124, 125, 135, 150, 250, 300, 500, 600, 800, 900, 1000, 1200 or 8000 Ω. Default: 600.	+3.00000000E+02
Enable dBm scaling with a reference resistance of 300 Ω: CALC:SCAL:DBM:REF 300 CALC:SCAL:FUNC DBM CALC:SCAL:STAT ON	

- The instrument sets the reference value to its default value after a Factory Reset (***RST**), an Instrument Preset (**SYSTem:PRESet**), or a change in measurement function.

CALCulate:SCALE:FUNction {DB|DBM|PCT|SCALE}

CALCulate:SCALE:FUNction?

Selects the operation performed by the scaling function.

Parameter	Typical Return
{DB DBM PCT SCALE}	DB, DBM, PCT, or SCALE
Enable the DB scaling function referenced to the next measurement taken: CALC:SCAL:FUNC DB CALC:SCAL:STAT ON	

- The PCT and SCALE functions apply only to the 34465A and 34470A.
- DB performs a relative dB computation. The result is the difference between the input signal and the stored DB relative value reference (**CALCulate:SCALE:DB:REFerence**), with both values converted to dBm (dB = measurement in dBm – relative value in dBm). For the dB function, the reference value can be automatically selected using the first measurement converted to dBm as the reference value (see **CALCulate:SCALE:REFerence:AUTO**), or it can be specified by **CALCulate:SCALE:DB:REFerence**. dB scaling applies to ACV and DCV measurements only.
- DBM performs a dBm computation. The result is logarithmic and is based on a calculation of power delivered to a reference resistance (**CALCulate:SCALE:DBM:REFerence**), relative to 1 milliwatt. (dBm = $10 \times \log_{10}(\text{measurement}^2 / \text{reference resistance} / 1 \text{ mW})$). dBm scaling applies to ACV and DCV measurements only.

- PCT performs a percent change operation. The result is the percent change of the measurement from the reference value:

$$\text{Result} = ((\text{Measurement} - \text{Reference}) / \text{Reference}) * 100$$

For the PCT function, the reference value can be automatically selected using the first measurement as the reference value (see [CALCulate:SCALE:REFERENCE:AUTO](#)), or it can be specified by [CALCulate:SCALE:REFERENCE](#). % scaling applies to all measurement functions except Ratio, Continuity, and Diode.

- SCALE performs an Mx-B operation. The result is the measurement multiplied by the gain value M ([CALCulate:SCALE:GAIN](#)) minus the offset value B ([CALCulate:SCALE:OFFSet](#)). Mx-B scaling applies to all measurement functions except Ratio, Continuity, and Diode.
- Scaling function results must be in the range of -1.0E+24 to -1.0E-24, or +1.0E-24 to 1.0E+24. Results outside these limits will be replaced with -9.9E37 (negative infinity), 0, or 9.9E37 (positive infinity).
- You must execute [CALCulate:SCALE:FUNCTION](#) *before* executing [CALCulate:SCALE\[:STATe\]](#), otherwise an incompatibility error will be generated.
- This parameter is set to its default value after a Factory Reset ([*RST](#)) or Instrument Preset ([SYSTem:PRESet](#)).
- Scaling is set to OFF when you change measurement functions (for example, changing from DCV to ACV). You must re-enable scaling after changing measurement functions.

CALCulate:SCALE:GAIN {<gain>|MIN|MAX|DEF}

CALCulate:SCALE:GAIN? [{MIN|MAX|DEF}]

Stores a gain value **M** for the scaling function in [CALCulate:SCALE:FUNCTION](#).

Parameter	Typical Return
-1.0E+15 to -1.0E-15, 0.0, +1.0E-15 to 1.0E+15. Default: 1.0.	+1.00000000E+02
Enable Mx-B scaling with a gain of 100 and an offset of 5. CALC:SCAL:FUNC SCAL CALC:SCAL:GAIN 100 CALC:SCAL:OFFS 5 CALC:SCAL:STAT ON	

- Applies only to the 34465A and 34470A.
- The instrument sets the gain value to 0.0 after a Factory Reset ([*RST](#)) or Instrument Preset ([SYSTem:PRESet](#)).

CALCulate:SCALE:OFFSet {<offset>|MIN|MAX|DEF}
CALCulate:SCALE:OFFSet? [{MIN|MAX|DEF}]

Stores an offset value **B** for the scaling function in [CALCulate:SCALE:FUNCTion](#).

Parameter	Typical Return
-1.0E+15 to -1.0E-15, 0.0, +1.0E-15 to 1.0E+15. Default: 0.0.	+5.00000000E+00
Enable Mx-B scaling with a gain of 100 and an offset of 5. CALC:SCAL:FUNC SCAL CALC:SCAL:GAIN 100 CALC:SCAL:OFFS 5 CALC:SCAL:STAT ON	

- Applies only to the 34465A and 34470A.
- The instrument sets the offset value to 0.0 after a Factory Reset (***RST**) or Instrument Preset (**SYSTem:PRESet**).

CALCulate:SCALE:REFerence {<reference>|MIN|MAX|DEF}
CALCulate:SCALE:REFerence? [{MIN|MAX|DEF}]

Stores a reference value for the PCT function in [CALCulate:SCALE:FUNCTion](#).

Parameter	Typical Return
-1.0E+15 to -1.0E-15, 0.0, +1.0E-15 to 1.0E+15. Default: 0.0.	+3.00000000E+02
Enable PCT scaling with a 100V reference. CALC:SCAL:REF 100 CALC:SCAL:FUNC PCT CALC:SCAL:STAT ON	

- Applies only to the 34465A and 34470A.
- Specifying a reference value disables automatic reference selection ([CALCu- late:SCALE:REFerence:AUTO](#) OFF).
- The instrument sets the reference value to 0.0 with automatic reference selection enabled after a Factory Reset (***RST**) or Instrument Preset (**SYSTem:PRESet**), or a change in measurement function.

CALCulate:SCALE:REFerence:AUTO {ON|1|OFF|0}
CALCulate:SCALE:REFerence:AUTO?

Enables or disables automatic reference selection for the dB scaling functions.

Parameter	Typical Return
{ON 1 OFF 0}. Default: ON.	0 (OFF) or 1 (ON)
Enable the DB function with automatic reference selection and use the first measurement as the reference value: CALC:SCAL:DBM:REF 50 CALC:SCAL:FUNC DB CALC:SCAL:REF:AUTO ON CALC:SCAL:STAT ON READ?	

- **ON:** the first measurement made is used as the reference for all subsequent measurements, and automatic reference selection is disabled:
 - For the dB scaling function, the first measurement is converted to dBm, and [CALCulate:SCALE:DB:REFerence](#) is set to the result.
 - For the PCT scaling function, [CALCulate:SCALE:REFerence](#) is set to the first measurement.
- **OFF:** [CALCulate:SCALE:DB:REFerence](#) specifies the reference for DB scaling, [CALCulate:SCALE:REFerence](#) specifies the reference for PCT scaling.
- The instrument enables automatic reference selection when the scaling function is enabled ([CALCulate:SCALE:STATe ON](#)).
- This parameter is set to its default value after a Factory Reset (***RST**), an Instrument Preset (**SYSTEM:PRESet**), or a change in measurement function.
- You must execute `CALCulate:SCALE:FUNcTION` *before* executing `CALCulate:SCALE[:STATe]`, otherwise an incompatibility error will be generated.
- Scaling is set to OFF when you change measurement functions (for example, changing from DCV to ACV). You must re-enable scaling after changing measurement functions.

CALCulate:SCALE[:STATe] {ON|1|OFF|0}
CALCulate:SCALE[:STATe]?

Enables or disables the scaling function.

Parameter	Typical Return
{ON 1 OFF 0}. Default: OFF.	0 (OFF) or 1 (ON)
Enable the DB function with automatic reference selection and use the first measurement as the reference value: CALC:SCAL:DBM:REF 50 CALC:SCAL:FUNC DB CALC:SCAL:REF:AUTO ON CALC:SCAL:STAT ON READ?	

- Enabling the scaling function also enables automatic null value selection ([CALCulate:SCALE:REFERENCE:AUTO](#)).
- This parameter is set to its default value after a Factory Reset ([*RST](#)), an Instrument Preset ([SYSTEM:PRESet](#)), or a change in measurement function.
- Scaling is set to OFF when you change measurement functions (for example, changing from DCV to ACV). You must re-enable scaling after changing measurement functions.

CALCulate:SCALE:UNIT <quoted_string>
CALCulate:SCALE:UNIT?

Allows you to specify the custom label of up to four characters (for example, RPM or °C) for scaled measurements.

Parameter	Typical Return
<quoted_string> A quoted ASCII string of up to four characters.	"RPM"
Enable scaling with a gain of 100 and an offset of 5, and display "PSI" with measurements on the front panel. CALC:SCAL:FUNC SCAL CALC:SCAL:GAIN 100 CALC:SCAL:OFFS 5 CALC:SCAL:UNIT "PSI" CALC:SCAL:UNIT:STAT ON CALC:SCAL:STAT ON	

- Applies only to the 34465A and 34470A.
- <quoted_string> You can use letters (A-Z), numbers (0-9), an underscore (_), most standard punctuation (comma, ampersand, ...), and some symbols, including the degree symbol (°).
- If you set the measurement label to °C, °F, or K, this has no effect the temperature units set using [UNIT:TEMPerature](#).

- **CALCulate:SCALE:UNIT:STATe** controls whether the unit string is displayed when the scaling function is enabled.
- The instrument resets the units to the null string after a Factory Reset (***RST**) or an Instrument Preset (**SYSTem:PRESet**).

CALCulate:SCALE:UNIT:STATe {OFF|ON}

CALCulate:SCALE:UNIT:STATe?

Enables or disables displaying the unit string with measurements on the front panel when the scaling function is enabled.

Parameter	Typical Return
{ON 1 OFF 0}. Default: OFF.	0 (OFF) or 1 (ON)
Enable scaling with a gain of 100 and an offset of 5, and display "PSI" with measurements on the front panel. CALC:SCAL:FUNC SCAL CALC:SCAL:GAIN 100 CALC:SCAL:OFFS 5 CALC:SCAL:UNIT "PSI" CALC:SCAL:UNIT:STAT ON CALC:SCAL:STAT ON	

- Applies only to the 34465A and 34470A.
- **CALCulate:SCALE:UNIT** specifies the unit string to be displayed.
- The instrument disables displaying the unit string after a Factory Reset (***RST**) or an Instrument Preset (**SYSTem:PRESet**).

CALCulate:AVERage Subsystem

This subsystem calculates measurement statistics.

Command Summary

[CALCulate:AVERage:ALL?](#)

[CALCulate:AVERage:AVERage?](#)

[CALCulate:AVERage:CLEar\[:IMMEDIATE\]](#)

[CALCulate:AVERage:COUNT?](#)

[CALCulate:AVERage:MAXimum?](#)

[CALCulate:AVERage:MINimum?](#)

[CALCulate:AVERage:PTPeak?](#)

[CALCulate:AVERage:SDEVIation?](#)

[CALCulate:AVERage\[:STATE\]](#)

CALCulate:AVERage:ALL?

CALCulate:AVERage:AVERage?

CALCulate:AVERage:COUNT?

CALCulate:AVERage:MAXimum?

CALCulate:AVERage:MINimum?

CALCulate:AVERage:PTPeak?

CALCulate:AVERage:SDEViation?

The CALCulate:AVERage:ALL? query returns the arithmetic mean (average), standard deviation, minimum value and maximum value of all measurements taken since the statistics were last cleared. The count and peak-to-peak statistics are not returned by CALCulate:AVERage:ALL?.

The other six queries listed above return individual values.

Parameter	Typical Return
(none)	(see below)
Return the statistics of 100 frequency measurements:	
CONF:FREQ 1.0E3,.001 SAMP:COUN 100 CALC:AVER:STAT ON INIT *WAI CALC:AVER:ALL?	
Typical Response: +1.00520000E+03,+1.00512000E+03,+1.00527000E+03,+4.13500000E-01	

- Statistics are cleared when the measurement function changes or when any of these commands is executed:

[CALCulate:AVERage:STATe ON](#)

[CALCulate:AVERage:CLEAr](#)

[INITiate](#)

[MEASure: <function>?](#)

[READ?](#)

[*RST](#)

SYSTem:PRESet

- All values are returned in the form +1.23450000E+01.
- When dB or dBm scaling is used, the CALC:AVER:AVER and CALC:AVER:SDEV queries return +9.91000000E+37 (not a number).

CALCulate:AVERage:CLEar[:IMMEDIATE]

Clears all computed statistics: minimum, maximum, average, peak-to-peak, count and standard deviation.

Parameter	Typical Return
(none)	(none)
Clear the stored statistical data: CALC:AVER:CLE	

- Does not clear measurements in reading memory.
- Statistics are cleared when the measurement function changes or when any of these commands is executed:

[CALCulate:AVERage:STATe ON](#)

[CALCulate:AVERage:CLEar](#)

[INITiate](#)

[MEASure:<function>?](#)

[READ?](#)

[*RST](#)

[SYSTem:PRESet](#)

- To clear statistics, limits, histogram data, and measurement data, use [CALCulate:CLEar\[:IMMEDIATE\]](#).

CALCulate:AVERage[:STATe] {ON|1|OFF|0}

CALCulate:AVERage[:STATe]?

Enables or disables statistics computation.

Parameter	Typical Return
{ON 1 OFF 0}. Default: OFF.	0 (OFF) or 1 (ON)
Return the statistics of 100 frequency measurements: CONF:FREQ 1.0E3,.001 SAMP:COUN 100 CALC:AVER:STAT ON INIT *WAI CALC:AVER:ALL?	
Typical Response: +1.00520000E+03,+1.00512000E+03,+1.00527000E+03,+4.13500000E-01	

- Statistics are cleared when the measurement function changes or when any of these commands is executed:

CALCulate:AVERage:STATe ON

CALCulate:AVERage:CLEar

INITiate

MEASure: <function>?

READ?

*RST

SYSTem:PRESet

- The instrument turns this setting OFF when the measurement function is changed or after *RST or SYSTem:PRESet.

CALCulate:SMOothing Subsystem

This subsystem controls the smoothing (moving average) filter. This subsystem applies only to the 34465A and 34470A.

Command Summary

[CALCulate:SMOothing:RESPonse](#)

[CALCulate:SMOothing\[:STATe\]](#)

CALCulate:SMOothing:RESPonse {SLOW|MEDIum|FAST}

CALCulate:SMOothing:RESPonse?

Selects the number of measurements to be averaged by the moving average (boxcar) filter.

Parameter	Typical Return
{SLOW MEDIum FAST} SLOW = 100 measurements, MEDIum = 50 measurements, FAST = 10 measurements. Default: 10 measurements.	SLOW
Enable a 50-point moving average filter on 1000 measurements: CONF:VOLT 10 SAMP:COUN 1000 CALC:SMO:RESP MED CALC:SMO:STAT ON CALC:STAT ON READ? Typical Response: +9.99383828200000E+00,+9.99352315400000E+00,... (1000 measurements)	

- Applies only to the 34465A and 34470A.
- The smoothing (moving average) filter produces one result for each measurement made.
- The smoothing (moving average) filter is reset when the measurement function changes, by [INITiate:IMMEDIATE](#), [READ?](#), or [MEASure?](#), or if a reading is too far beyond the current average.
- After the smoothing (moving average) filter is reset, the filter produces results which are the average of all measurements made after the reset, until the required number of measurements are made as selected by [CALCulate:SMOothing:RESPonse](#). Once the required number measurements are made, the results are the moving average of the last 10, 50, or 100 measurements. Equal weighting is applied to all measurements used in the average.
- The instrument sets the response time to FAST after a Factory Reset ([*RST](#)) or after an Instrument Pre-set ([SYSTem:PRESet](#)).

CALCulate:SMOothing[:STATe] {OFF|ON}
CALCulate:SMOothing[:STATe]?

Enables or disables a smoothing (moving average) filter on the measurements. Smoothing is intended to average out small variations in the measurements. Larger variations will cause the filter to reset.

Parameter	Typical Return
{ON 1 OFF 0}. Default: ON.	0 (OFF) or 1 (ON)
Enable a 50-point moving average filter on 1000 measurements: CONF:VOLT 10 SAMP:COUN 1000 CALC:SMO:RESP MED CALC:SMO:STAT ON CALC:STAT ON READ? Typical Response: +9.99383828200000E+03,+9.99352315400000E+03,... (1000 measurements)	

- Applies only to the 34465A and 34470A.
- The **CALCulate** subsystem and the individual calculate functions are disabled for timestamp measurements.
- The instrument disables the smoothing (moving average) filter after a Factory Reset (***RST**) or an Instrument Preset (**SYSTem:PRESet**).

CALCulate:TCHart[:STATe] {ON|1|OFF|0}
CALCulate:TCHart[:STATe]?

Enables or disables trend chart data when controlling the instrument from remote.

Parameter	Typical Return
{OFF ON 0 1}. Default: OFF.	OFF or ON
Enable trend chart data on 500 measurements: CALCulate:TCHart:STATe ON CONF:VOLT:DC 10,0.003 SAMP:COUN 500 INIT FETC? Typical Response: +9.99383828200000E+00,+9.99352315400000E+00,... (500 measurements)	

- You must enable this (ON) *before* sending [INIT](#) or [READ?](#) to see trend chart data when controlling the instrument from remote. If it is disabled or enabled *after* [INIT](#) or [READ?](#), viewing the trend chart results in a chart with no data.
- Trend chart data must be disabled (OFF) to make measurements at the highest speed (50 kHz).
- This parameter is set to its default value after a Factory Reset ([*RST](#)) or Instrument Preset ([SYSTem:PRESet](#)).

CALibration Subsystem

NOTE

Read the [calibration procedure](#) before calibrating. Improper calibration can reduce accuracy and reliability.

[CALibration:ADC?](#)

[CALibration\[:ALL\]?](#)

[CALibration:COUNT?](#)

[CALibration:DATE?](#)

[CALibration:SECure:CODE](#)

[CALibration:SECure:STAtE](#)

[CALibration:STORe](#)

[CALibration:STRing](#)

[CALibration:TEMPerature?](#)

[CALibration:TIME?](#)

[CALibration:VALue](#)

CALibration:ADC?

Performs a low-level calibration of the ADC (analog-to-digital converter) circuitry.

NOTE

You must unsecure the instrument to calibrate it or to change the calibration string or security code.

Parameter	Typical Return
(none)	0 (successful) or 1 (unsuccessful)
Calibrate the ADC:	
CAL:ADC?	

- This is the first step in a re-calibration sequence, and must be done before doing the offset calibration.

CALibration[:ALL]?

Performs a calibration using the calibration value based on the function and range ([CALibration:VALue](#)). A short must be applied for the resistance and voltage measurement functions, and the inputs must be open for the current measurement functions.

NOTE You must unsecure the instrument to calibrate it or to change the calibration string or security code.

Parameter	Typical Return
(none)	+0 (pass) or +1 (fail)
Perform a zero calibration of the ACV measurement function and return a pass/fail indication:	
CONF:VOLT:AC	
CAL:SEC:STAT OFF,MY_CAL_CODE	
CAL:VAL 0.0	
CAL?	
CAL:STOR	
CAL:SEC:STAT ON	

- This query increments the instrument’s calibration count ([CALibration:COUNT?](#)) and modifies the volatile version of the calibration constants. Use [CALibration:STORe](#) to save these constants in nonvolatile memory at end of calibration.

CALibration:COUNT?

Returns the calibration count. Read and record the initial count when you first receive your instrument.

Parameter	Typical Return
(none)	+117
Return the calibration count:	
CAL:COUN?	

- Because the value increments each time you store the calibration constants, a complete calibration adds many counts. The calibration count also increments whenever you save a calibration string, change the calibration password, or override the calibration security.
- You can perform this query regardless of whether the instrument is secured.
- This setting is non-volatile; it will not be changed by power cycling or [*RST](#) or [SYSTem:PRESet](#).

See Also

[SYSTem:SECurity:COUNT?](#)

CALibration:DATE?

Returns the date of the last calibration in the format *yyyy,mm,dd*.

Parameter	Typical Return
(none)	2014,4,26
Return the calibration date: CAL:DATE?	

- You can perform this query regardless of whether the instrument is secured.
- The date is based on the instrument's real-time clock. Set the date for the instrument's real-time clock with [SYSTem:DATE](#) and [SYSTem:TIME](#).
- This setting is non-volatile; it will not be changed by power cycling or [*RST](#) or [SYSTem:PRESet](#).

See Also

[SYSTem:DATE](#)

[SYSTem:TIME](#)

CALibration:SECure:CODE <new_code>

Sets the security code to prevent unauthorized calibrations.

NOTE You must unsecure the instrument to calibrate it or to change the calibration string or security code.

Parameter	Typical Return
Unquoted string up to 12 characters Must start with letter (A-Z) May contain letters, numbers (0-9) and underscores	(none)
Set new security code: CAL:SEC:STAT OFF,OLD_CAL_CODE CAL:SEC:CODE TST_DUT165 CAL:SEC:STAT ON	

- To change the code: unsecure calibration memory with the old code, then set the new code.
- If you forget your security code, see [Security Code Override](#).
- When shipped from the factory, the instrument is secured, with the security code set to **AT3446XA**.
- This setting is non-volatile; it will not be changed by power cycling or [*RST](#) or [SYSTem:PRESet](#).

CALibration:SECure:STATe {ON|1|OFF|0}[, <code>]

CALibration:SECure:STATe?

Unsecures or secures the instrument for calibration.

NOTE You must unsecure the instrument to calibrate it or to change the calibration string or security code.

Parameter	Typical Return
{ON 1 OFF 0}. Default: ON.	0 (OFF) or 1 (ON)
Unsecure calibration:	
CAL:SEC:STAT OFF,MY_CODE_272	
Secure calibration:	
CAL:SEC:STAT ON	

- The <code> is optional to secure the instrument, but must be correct if provided.
- When shipped from the factory, the instrument is secured, with the security code set to **AT3446XA**.
- Front panel and remote interface calibration share the same code.
- This setting is non-volatile; it will not be changed by power cycling or [*RST](#) or [SYSTem:PRESet](#).

CALibration:STORe

Takes calibration constants in volatile memory ([CALibration:ALL?](#)), and places them in nonvolatile memory, where they are not changed by cycling power, [*RST](#), or [SYSTem:PRESet](#). Do this at the end of calibration to avoid losing changes.

NOTE You must unsecure the instrument to calibrate it or to change the calibration string or security code.

Parameter	Typical Return
(none)	(none)
Store calibration constants into non-volatile memory:	
CAL:STOR	

CALibration:STRing "<string>"
CALibration:STRing?

Stores a message in calibration memory. Common messages include the last calibration date, calibration due date, or calibration department contact information. You can perform this query regardless of whether the instrument is secured.

NOTE You must unsecure the instrument to calibrate it or to change the calibration string or security code.

Parameter	Typical Return
Quoted string up to 40 characters May contain letters, numbers, spaces, and other common characters.	"FOR CAL HELP, CALL JOE AT EXT 1234" (If no string stored, returns "")
CAL:STR "FOR CAL HELP, CALL JOE AT EXT 1234"	

- This string may be stored only from the remote interface, but you can read the message from the front panel or remote interface.
- Storing a calibration message overwrites the previous message.
- This setting is non-volatile; it will not be changed by power cycling or [*RST](#) or [SYSTem:PRESet](#).

CALibration:TEMPerature?

Returns the temperature of the last calibration in °C.

Parameter	Typical Return
(none)	+2.42850208E+001
Return the calibration temperature: CAL:TEMP?	

- You can perform this query regardless of whether the instrument is secured.
- This setting is non-volatile; it will not be changed by power cycling or [*RST](#) or [SYSTem:PRESet](#).

CALibration:TIME?

Returns the amount of time since the last calibration in the format *hh,mm,ss.sss*.

Parameter	Typical Return
(none)	20,15,30.000
Return the calibration time: CAL:TIME?	

- You can perform this query regardless of whether the instrument is secured.
- This setting is non-volatile; it will not be changed by power cycling or [*RST](#) or [SYSTem:PRESet](#).

See Also

[SYSTem:TIME](#)

[SYSTem:DATE](#)

CALibration:VALue <value>

CALibration:VALue?

Specifies the value of the applied calibration signal.

NOTE You must unsecure the instrument to calibrate it or to change the calibration string or security code.

Parameter	Typical Return
Numeric, default 0.0	+2.37000000E-02
Specify calibration value 0.0237:	
CAL:VAL 2.37E-2	

- This parameter is set to its default value after a Factory Reset ([*RST](#)) or Instrument Preset ([SYSTem:PRESet](#)).

CONFigure Subsystem

The CONFigure commands are the most concise way to configure measurements. Like the [MEASure?](#) queries, these commands use default measurement configuration values. However, these commands do not automatically start measurements, so you can modify measurement attributes before initiating the measurement.

NOTE Use [INITiate](#) or [READ?](#) to initiate measurements.

Command Summary

[CONFigure?](#)

[CONFigure:CAPacitance](#)

[CONFigure:CONTInuity](#)

[CONFigure:CURREnt:{AC|DC}](#)

[CONFigure:DIODe](#)

[CONFigure:{FREQuency|PERiod}](#)

[CONFigure:{RESistance|FRESistance}](#)

[CONFigure:TEMPerature](#)

[CONFigure\[:VOLTagE\]:{AC|DC}](#)

[CONFigure\[:VOLTagE\]\[:DC\]:RATio](#)

Default Settings for the CONFigure Command

The CONFigure commands select the function, range and resolution in one command. Specify *<resolution>* in the measurement's units (V, A, Hz, Ω , and so on). All other parameters are set to their default values (below).

Measurement Parameter	Default Setting
AC Input Filter (bandwidth)	20 Hz (medium filter)
Autozero	OFF if resolution setting results in NPLC < 1 ON if resolution setting results in NPLC \geq 1
Range	AUTO (including voltage range for frequency and period measurements)
Samples per Trigger	1 sample
Trigger Count	1 trigger
Trigger Delay	Automatic delay
Trigger Source	Immediate
Trigger Slope	NEGative
Math Functions	Disabled. Other parameters are unchanged.
Per-function Null State	Disabled

Using CONFigure

The following example uses CONFigure and [READ?](#) to make an externally-triggered measurement. CONFigure specifies DC voltage measurements but does not place the instrument in the "wait-for-trigger" state.

[READ?](#) places the instrument in the "wait-for-trigger" state, initiates a measurement when the rear-panel **Ext Trig** input is pulsed (low by default), stores the measurement in reading memory, and transfers the measurement to the instrument's output buffer. The default range (autorange) and resolution (10 PLC) are used for the measurement.

```
CONF:VOLT:DC
TRIG:SOUR EXT
READ?
```

Typical Response: +4.27150000E+00

The following example is like the previous one, but it uses [INITiate](#) and [FETCh?](#) instead of [READ?](#). The [INITiate](#) command places the instrument in the "wait-for-trigger" state, triggers a measurement when the rear-panel **Ext Trig** input is pulsed (low by default), and sends the measurement to reading memory. The [FETCh?](#) query transfers the measurement from reading memory to the instrument's output buffer.

```
CONF:VOLT:DC
TRIG:SOUR EXT
INIT
FETC?
```

Typical Response: +5.34250000E+00

Storing measurements in reading memory with [INITiate](#) is faster than sending measurements to the instrument's output buffer using [READ?](#) (provided you do not send [FETCh?](#) until done). The [INITiate](#) command is also an "overlapped" command. This means that after executing [INITiate](#), you can send other commands that do not affect the measurements. This allows you to check for data availability before initiating a read attempt that might otherwise time out. The [FETCh?](#) query waits until all measurements are complete to terminate. You can store up to 1,000 measurements in the reading memory of the 34460A, 10,000 measurements on the 34461A, 50,000 measurements on the 34465A/70A (*without* the MEM option), or 2,000,000 measurements on the 34465A/70A (*with* the MEM option).

The following example configures the instrument for 2-wire resistance measurements, triggers the instrument to make one measurement using [INITiate](#), and stores the measurement in reading memory. The 10 k Ω range is selected with 100 Ω resolution.

```
CONF:RES 10000,100
INIT
FETC?
```

Typical Response: +5.95850000E+03

CONFigure?

Returns a quoted string indicating the present function, range, and resolution. The short form of the function name (CURR:AC, FREQ) is always returned.

Parameter	Typical Return
(none)	"VOLT +1.00000000E+01,+3.00000000E-06"
Return the present function, range, and resolution: CONF?	

CONFigure:CAPacitance [{<range>|AUTO|MIN|MAX|DEF} [, {<resolution>|MIN|MAX|DEF}]]

Sets all measurement and trigger parameters to their [default values](#) for capacitance measurements. Also specifies the range.

Parameter	Typical Return
<range>: {1 nF 10 nF 100 nF 1 µF 10 µF 100 µF}. Default: AUTO.	(none)
<resolution>: optional and ignored; fixed at 4½ digits.	
Configure capacitance measurements using the 1 µF range. Make and read two measurements: CONF:CAP SAMP:COUN 2 READ? Typical Response: +3.01574316E-10,+3.01659030E-10	

- You can let autoranging select the measurement range, or you can manually select a fixed range. Autoranging conveniently selects the range for each measurement based on the input signal. For fastest measurements, use manual ranging (autoranging may require additional time for range selection).
- Autoranging (AUTO or DEFault), will generate an error if you specify a <resolution> because the instrument cannot accurately resolve the integration time (especially if the input continuously changes). If your application requires autoranging, specify DEFault for the <resolution> or omit the <resolution> altogether.
- Autoranging goes down a range at less than 10% of range and up a range at greater than 120% of range. For capacitance measurements only, when autorange is off, the instrument does not report an overload for readings greater than 120% of range. Overload only occurs when the algorithm times out because the applied capacitance is too large for the algorithm to measure. If you apply a DC voltage or a short to the input terminals in capacitance measurement mode, the instrument reports an overload.
- If the input signal is greater than can be measured on the specified manual range, the instrument displays the word *Overload* on front panel and returns "9.9E37" from the remote interface.
- Use [READ?](#) or [INITiate](#) to start the measurement.

CONFigure:CONTInuity

Sets all measurement parameters and trigger parameters to their [default values](#) for continuity measurements.

Parameter	Typical Return
(none)	+1.32130000E-02
Configure the instrument for continuity measurements. Then make a measurement using an external trigger with positive slope (rising edge) and read the measurement: CONF:CONT TRIG:SOUR EXT;SLOP POS READ?	

- The range and resolution are fixed at 1 kΩ for continuity tests (a 2-wire resistance measurement).
- The instrument beeps (if the beeper is enabled) for each measurement less than or equal to the continuity threshold ($\leq 10 \Omega$), and the actual resistance measurement appears on the display.
- From 10 Ω to 1.2 kΩ, the instrument displays the actual resistance measurement with no beep. Above 1.2 kΩ, the instrument displays "OPEN" with no beep.
- The [FETCh?](#), [READ?](#), and [MEASure:CONTInuity?](#) queries return the measured resistance, regardless of its value.
- Use [READ?](#) or [INITiate](#) to start the measurement.

CONFigure:CURRent:{AC|DC} [{<range>|AUTO|MIN|MAX|DEF} [, {<resolution>|MIN|MAX|DEF}]]

Sets all measurement parameters and trigger parameters to their [default values](#) for AC or DC current measurements. Also specifies the range and resolution.

Parameter	Typical Return
<p><range>: {100 μA 1 mA 10 mA 100 mA 1 A 3 A 10 A}. Default: AUTO (autorange).</p> <p><resolution> (AC): optional and ignored; fixed at 6½ digits.</p> <p><resolution> (DC): See Resolution Table or Range, Resolution and NPLC. The default is equivalent to 10 PLC. Specify <resolution> in the measurement's units (V, A, Hz, Ω, and so on).</p>	(none)
<p>Configure AC current measurements using the 1 A range. Make and read two measurements:</p> <pre>CONF:CURR:AC 1 SAMP:COUN 2 READ?</pre> <p>Typical Response: +8.54530000E-01,+8.54520000E-01</p> <p>Configure DC current measurements using the 1 A range with 1 mA resolution. Then make a measurement using an external trigger with positive slope (rising edge) and read the measurement:</p> <pre>CONF:CURR:DC 1,0.001 TRIG:SOUR EXT;SLOP POS INIT FETC?</pre> <p>Typical Response: +4.27150000E-01</p>	

- Choosing the 10 A range automatically sets the [SENSe:]CURRent:{AC|DC}:TERMinals parameter to 10 A, and setting the range to 3 A or less sets the [SENSe:]CURRent:{AC|DC}:TERMinals parameter to 3 A.
- For the 34461A/65A/70A, when the Front/Rear switch is set to Front, setting the range to MAX selects the 10A range and the 10A terminals. When the Front/Rear switch is set to Rear, setting the range to MAX selects the 3A range and 3A terminals.
- You can let autoranging select the measurement range, or you can manually select a fixed range. Autoranging conveniently selects the range for each measurement based on the input signal. For fastest measurements, use manual ranging (autoranging may require additional time for range selection).
- Autoranging (AUTO or DEFault), will generate an error if you specify a <resolution> because the instrument cannot accurately resolve the integration time (especially if the input continuously changes). If your application requires autoranging, specify DEFault for the <resolution> or omit the <resolution> altogether.
- Autoranging goes down a range at less than 10% of range and up a range at greater than 120% of range.
- If the input signal is greater than can be measured on the specified manual range, the instrument displays the word *Overload* on front panel and returns "9.9E37" from the remote interface.
- To control the measurement rate for AC measurements, change the trigger delay or AC filter band-

width.

- Use [READ?](#) or [INITiate](#) to start the measurement.

See Also

[CONFigure?](#)

[MEASure:CURRent:{AC|DC}?](#)

[\[SENSe:\]CURRent:AC:BANDwidth](#)

CONFigure:DIODE

Sets all measurement parameters and trigger parameters to their [default values](#) for diode tests.

Parameter	Typical Return
(none)	(none)
Configure, make, and read a default diode measurement:	
CONF:DIOD	
READ?	
Typical Response: +1.32130000E-01	

- The range and resolution are *fixed* for diode tests: the range is 1 VDC (with a 1 mA current source output).
- The voltage is displayed on the front panel if it is between 0 and 5.05 V. The instrument beeps when the signal transitions into the range between 0.3 and 0.8 V (unless beeper is disabled). If the signal exceeds 5.05 V, the front panel shows "OPEN", and the value returned from SCPI is 9.9E37.
- The [FETCh?](#), [READ?](#), and [MEASure:DIODE?](#) queries return the measured voltage, regardless of its value.
- Use [READ?](#) or [INITiate](#) to start the measurement.

CONFigure:{FREQUENCY|PERiod} [{<range>|MIN|MAX|DEF} [, {<resolution>|MIN|MAX|DEF}]]

Sets all measurement and trigger parameters to their [default values](#) for frequency or period measurements. Also specifies the *frequency* or *period* range and resolution.

Parameter	Typical Return
<range>: 3 Hz to 300 kHz. Default: 20 Hz. (FREQUENCY)	(none)
<range>: 3.33 μs to 333.33 ms. Default: 50 ms (PERiod).	
<resolution>: See table below. Specify <resolution> in the measurement's units (V, A, Hz, Ω, and so on).	
Configure frequency measurements using the default aperture and the 200 Hz (fast) AC filter. Then make and read one measurement: CONF:FREQ FREQ:RANG:LOW 200 READ? Typical Response: +1.32130000E+03	

- The 1 mS aperture applies only to the 34465A and 34470A.
- The frequency or period <range> parameter is required only to specify the measurement resolution parameter. It is not necessary to send a new command for each new frequency or period to be measured. The <range> and <resolution> parameters affect the aperture (gate time) as follows:

Resolution (34460A/61A)	Resolution (34465A/70A)	Aperture
Not Applicable	100 ppm × <range> (MAXimum)	1 ms
100 ppm × <range> (MAXimum)	10 ppm × <range> (DEFault)	10 ms
10 ppm × <range> (DEFault)	1 ppm × <range>	100 ms
1 ppm × <range> (MINimum)	0.1 ppm × <range> (MINimum)	1 s

- The input signal for frequency or period measurements has an AC voltage component. Use [\[SENSe:\] {FREQUENCY|PERiod}:VOLTage:RANGe:AUTO](#) to disable or enable voltage autoranging or use [CONFigure:{FREQUENCY|PERiod}](#) to select voltage autoranging by default. Use [\[SENSe:\] {FREQUENCY|PERiod}:VOLTage:RANGe](#) to select a fixed voltage range for frequency and period measurements.
- If the input voltage is too large for the selected voltage range (manual ranging), the instrument displays the word Overload on the front panel and returns "9.9E37" from the remote interface. Autoranging can be enabled for the input voltage.
- Use [READ?](#) or [INITiate](#) to start the measurement.

See Also

[CONFigure?](#)

[MEASure:{FREQUENCY|PERiod}?](#)

CONFigure:{RESistance|FRESistance} [{<range>|AUTO|MIN|MAX|DEF} [, {<resolution>|MIN|MAX|DEF}]]

Sets all measurement parameters and trigger parameters to their [default values](#) for 4-wire (FRESistance) or 2-wire (RESistance) resistance measurements. Also specifies the range and resolution.

Parameter	Typical Return
<range>: 100 Ω, 1 kΩ, 10 kΩ, 100 kΩ, 1 MΩ, 10 MΩ, 100 MΩ, 1 GΩ, AUTO, or DEFault. Default: AUTO.	+8.54530000E+01
<resolution>: See Resolution Table or Range, Resolution and NPLC . The default is equivalent to 10 PLC.	
Specify <resolution> in the measurement's units (V, A, Hz, Ω, and so on).	
Configure 4-wire resistance measurements using the 100 Ω range with default resolution. Make and read two measurements: CONF:FRES 100 SAMP:COUN 2 READ? Typical Response: +8.54530000E+01,+8.54520000E+01	

- The 1 GΩ range applies only to the 34465A and 34470A.
- You can let autoranging select the measurement range, or you can manually select a fixed range. Autoranging conveniently selects the range for each measurement based on the input signal. For fastest measurements, use manual ranging (autoranging may require additional time for range selection).
- Autoranging (AUTO or DEFault), will generate an error if you specify a <resolution> because the instrument cannot accurately resolve the integration time (especially if the input continuously changes). If your application requires autoranging, specify DEFault for the <resolution> or omit the <resolution> altogether.
- Autoranging goes down a range at less than 10% of range and up a range at greater than 120% of range.
- If the input signal is greater than can be measured on the specified manual range, the instrument displays the word *Overload* on front panel and returns "9.9E37" from the remote interface.
- Use [READ?](#) or [INITiate](#) to start the measurement.

See Also

[CONFigure?](#)

[MEASure:{RESistance|FRESistance}?](#)

CONFigure:TEMPerature [{FRTD|RTD|FTHermistor|THERmistor|TCouple|DEFAult}] [, {<type>|DEFAult}] [, 1 [, {<resolution>|MIN|MAX|DEF}]]]]

Sets all measurement parameters and trigger parameters to their [default values](#) for temperature measurements. Also specifies the transducer and the measurement resolution.

Parameter	Typical Return
<probe_type>: {FRTD RTD FTHermistor THERmistor TCouple}. Default: FRTD.	+2.12320000E+01
<type>: 85 (only possible value for RTD/FRTD), 5000 (only possible value for THERmistor/FTHermistor), or E, J, K, N, R, T (TCouple).	
<resolution>: See Resolution Table or Range, Resolution and NPLC . The default is equivalent to 10 PLC.	
Configure a 4-wire RTD measurement. Then make a measurement using an external trigger with positive slope (rising edge) and read the measurement: CONF:TEMP FRTD,85 TRIG:SOUR EXT;SLOP POS READ?	

- Thermocouple measurements (TC) apply only to the 34465A and 34470A.
- For temperature measurements, the instrument internally selects the range; you cannot select the range to be used.
- The <resolution> parameter only determines the integration time; it does not specify the resolution of the temperature measurement. This parameter is optional; however, if you specify <resolution>, you must also specify "1" as the implied range parameter. For example: CONF:TEMP RTD,85,1,0.000001 selects the 10 PLC integration time on the 34461A.
- To change temperature units, use [UNIT:TEMPerature](#).
- For RTD and thermistor measurements, the instrument autoranges to the correct range for the transducer resistance measurement. For thermocouple measurements, the 100 mV range is selected.
- For thermocouple measurements, the internal reference is selected. See [SENSe:TEMPerature:TCouple:RJUNction:TYPE](#).
- If the input signal is greater than can be measured on the specified manual range, the instrument displays the word *Overload* on front panel and returns "9.9E37" from the remote interface.
- Use [READ?](#) or [INITiate](#) to start the measurement.

CONFigure[:VOLTage]:{AC|DC} [{<range>|AUTO|MIN|MAX|DEF} [, {<resolution>|MIN|MAX|DEF}]]

Sets all measurement parameters and trigger parameters to their [default values](#) for AC or DC voltage measurements. Also specifies the range and resolution.

WARNING The maximum range parameter (MAX) is 1000 V. However, the SAFETY LIMIT on the front and rear HI/LO input terminals is 750 VAC (rms). The rms voltage is waveform dependent. A sine wave is limited to 750 VAC (rms), but a 1000 Vpk square wave is safe. Connection to AC mains power is further limited to CAT II (300 V). See [Safety and Regulatory Information](#) for more information on the safety features and the safe operation of this instrument.

Parameter	Typical Return
<range>: {100 mV 1 V 10 V 100 V 1000 V}. Default: AUTO (autorange).	(none)
<resolution> (AC): optional and ignored; fixed at 6½ digits.	
<resolution> (DC): See Resolution Table or Range, Resolution and NPLC . The default is equivalent to 10 PLC. Specify <resolution> in the measurement's units (V, A, Hz, Ω, and so on).	
Configure AC voltage measurements using the 100 V range. Make and read two measurements: CONF:VOLT:AC 100 SAMP:COUN 2 READ? Typical Response: +8.54530000E+01,+8.54520000E+01	
Configure DC voltage measurements using the 10 V range with 1 mV resolution. Then make a measurement using an external trigger with positive slope (rising edge) and read the measurement: CONF:VOLT:DC 10,0.001 TRIG:SOUR EXT;SLOP POS INIT FETC? Typical Response: +4.27150000E+00	

- You can let autoranging select the measurement range, or you can manually select a fixed range. Autoranging conveniently selects the range for each measurement based on the input signal. For fastest measurements, use manual ranging (autoranging may require additional time for range selection).
- Autoranging (AUTO or DEFault), will generate an error if you specify a <resolution> because the instrument cannot accurately resolve the integration time (especially if the input continuously changes). If your application requires autoranging, specify DEFault for the <resolution> or omit the <resolution> altogether.
- Autoranging goes down a range at less than 10% of range and up a range at greater than 120% of range.
- If the input signal is greater than can be measured on the specified manual range, the instrument displays the word *Overload* on front panel and returns "9.9E37" from the remote interface.
- To control the measurement rate for AC measurements, change the trigger delay or AC filter band-

width.

- Use [READ?](#) or [INITiate](#) to start the measurement.

See Also

[CONFigure?](#)

[MEASure\[:VOLTage\]:{AC|DC}?](#)

[\[SENSe:\]CURRent:AC:BANDwidth](#)

CONFigure[:VOLTage][:DC]:RATio [{<range>|AUTO|MIN|MAX|DEF} [, {<resolution>|MIN|MAX|DEF}]]

Sets all measurement and trigger parameters to their [default values](#) for DC voltage to DC voltage ratio measurements. Also specifies the range and resolution.

To calculate a ratio, the instrument measures a DC reference voltage applied to the *Sense* terminal and the DC signal voltage applied to the *Input* terminals. It then uses the formula:

$$\text{Ratio} = \text{DC signal voltage} / \text{DC reference voltage}$$

Parameter	Typical Return
<range>: {100 mV 1 V 10 V 100 V 1000 V}. Default: AUTO (autorange).	(none)
<resolution>: See Resolution Table or Range, Resolution and NPLC . The default is equivalent to 10 PLC.	
Configure the instrument for DC voltage ratio measurements using the 100 V range with 1 mV resolution. Then make a measurement using an external trigger with positive slope (rising edge) and read the measurement: CONF:VOLT:DC:RAT 100,0.001 TRIG:SOUR EXT;SLOP POS INIT FETC? Typical Response: +4.27150000E+00	

- The *Sense* terminals have a maximum measurable input of ±12 VDC. Autoranging is automatically selected for reference voltage measurements on the *Sense* terminals.
- The *Input LO* and *Sense LO* terminals must have a common reference and cannot have a voltage difference greater than ±2 V.
- The specified measurement range applies only to the signal connected to the *Input* terminals. The signal on the *Input* terminals can be any DC voltage up to 1,000 V.
- For the *Input* terminals, you can allow the instrument to select the measurement range by autoranging or you can select a fixed range using *manual ranging*. Autoranging decides which range to use for each measurement based on the input signal. For faster measurements, use manual ranging on each measurement (additional time is required for autoranging to select a range).
- Autoranging (AUTO or DEFault), will generate an error if you specify a <resolution> because the instrument cannot accurately resolve the integration time (especially if the input continuously changes). If your application requires autoranging, specify DEFault for the <resolution> or omit the <resolution> altogether.
- Autoranging goes down a range at less than 10% of range and up a range at greater than 120% of range.
- If the input signal is greater than can be measured on the specified manual range, the instrument displays the word *Overload* on front panel and returns "9.9E37" from the remote interface.
- Use [READ?](#) or [INITiate](#) to start the measurement.

See Also

[CONFigure?](#)

[MEASure\[:VOLTage\]\[:DC\]:RATio?](#)

DATA Subsystem

This subsystem allows you to configure and remove data from reading memory. The instrument clears all measurements from reading memory when the measurement configuration changes, or when any of these commands are executed: [INITiate](#), [MEASure:<function>?](#), [READ?](#), [*RST](#), [SYSTEM:PRESet](#).

Command Summary

[DATA:LAST?](#)

[DATA:POINts?](#)

[DATA:POINts:EVENT:THReshold](#)

[DATA:REMOve?](#)

DATA:LAST?

Returns the last measurement taken. You can execute this query at any time, even during a series of measurements.

Parameter	Typical Return
(none)	(none)
Return the last measurement: DATA:LAST? Typical Response: One measurement with units. If no data is available, 9.91E37 (Not a Number) is returned with units. Example: +1.73730000E+00 VDC	

DATA:POINts?

Returns the total number of measurements currently in reading memory. You can execute this query at any time, even during a series of measurements.

Parameter	Typical Return
(none)	(none)
Return the number of measurements in reading memory: DATA:POIN? Typical Response: +215	

- You can store up to 1,000 measurements in the reading memory of the 34460A, 10,000 measurements on the 34461A, 50,000 measurements on the 34465A/70A (*without* the MEM option), or 2,000,000 measurements on the 34465A/70A (*with* the MEM option).

DATA:POINts:EVENT:THReshold <count>

DATA:POINts:EVENT:THReshold?

Sets the number of measurements to store in reading memory before setting bit 9 in the Standard Operation Register group event register to 1. An event register is a read-only register that latches events from the condition register. While an event bit is set, subsequent events corresponding to that bit are ignored.

NOTE For more information on the SCPI Status System, see [Status Subsystem Introduction](#).

Parameter	Typical Return
34460A: 1 to 1,000 readings 34461A: 1 to 10,000 readings 34465A/70A: 1 to 50,000 readings (without the MEM option), or 1 to 2,000,000 readings (with the MEM option) The default value is 1 for both models.	+125
Set the reading memory threshold to 125 measurements: DATA:POIN:EVEN:THR 125	

- To report any subsequent events, the measurement count must first drop below the programmed threshold before reaching the threshold again.
- Use [STATus:OPERation:ENABle](#) to enable the Memory Threshold bit (bit 9 in the Standard Operation Event register) to be reported to the Status Byte.
- Once the Memory Threshold bit (bit 9 in the Standard Operation Event register) is set, it remains set until cleared by [STATus:OPERation:EVENT?](#) or [*CLS](#).
- The Standard Operation Condition register shows the current condition. See [STATus Subsystem Introduction](#) for further information.
- This parameter is set to its default value after a Factory Reset ([*RST](#)) or Instrument Preset ([SYSTem:PRESet](#)).

DATA:REMove? <num_readings> [,WAIT]

Reads and erases <num_readings> measurements from the reading memory. If fewer than <num_readings> measurements are available, the query returns an error unless the WAIT parameter is specified, in which case the query waits until <num_readings> measurements are available.

Parameter	Typical Return
34460A: 1 to 1,000 readings 34461A: 1 to 10,000 readings 34465A/70A: 1 to 50,000 readings (without the MEM option), or 1 to 2,000,000 readings (with the MEM option)	(none)
Read and erase the three oldest readings from reading memory: DATA:REMove? 3 Typical Response: -4.97215654E-01,-4.97343268E-01,-4.97121213E-01	

- The [R?](#) and [DATA:REMove?](#) queries can be used during a long series of readings to periodically remove readings from memory that would normally cause the reading memory to overflow. [R?](#) does not wait for all readings to complete. It sends the readings that are complete at the time the instrument receives the command. Use [Read?](#) or [Fetch?](#) if you want the instrument to wait until all readings are complete before sending readings.
- You can store up to 1,000 measurements in the reading memory of the 34460A, 10,000 measurements on the 34461A, 50,000 measurements on the 34465A/70A (*without* the MEM option), or 2,000,000 measurements on the 34465A/70A (*with* the MEM option). If reading memory overflows, new measurements overwrite the oldest measurements stored; the most recent measurements are always preserved. No error is generated, but the Reading Mem Ovfl bit (bit 14) is set in the Questionable Data Register's condition register (see [Status System Introduction](#)).

DISPlay Subsystem

This subsystem controls the instrument's display.

Command Summary

[DISPlay\[:STATe\]](#)

[DISPlay:TEXT\[:DATA\]](#)

[DISPlay:TEXT:CLEAr](#)

[DISPlay:VIEW](#)

DISPlay[:STATe] {ON|1|OFF|0}

DISPlay[:STATe]?

Disables or enables the front panel display. When disabled, the display dims, and all annunciators are disabled. However, the screen remains on.

Parameter	Typical Return
{ON 1 OFF 0}. Default: ON.	0 (OFF) or 1 (ON)
Turn display off: DISP OFF	

- Disabling the display improves command execution speed from the remote interface and provides basic security.
- Sending [DISPlay:TEXT <string>](#) will display the text even with [DISP:STAT OFF](#).
- The display is enabled when power is cycled, or when you return to local (front panel) operation by pressing the [Local] key.

DISPlay:TEXT[:DATA] "<string>"

DISPlay:TEXT[:DATA]?

Displays a text message on the front panel display.

Parameter	Typical Return
A quoted string of up to 40 characters. You can use letters (A-Z), numbers (0-9) and special characters such as @, %, *, and so forth. Default ""	"Test in progress..."
Show message on display: DISP:TEXT "Test in progress..."	

- Sending [DISPlay:TEXT <string>](#) will display the text even with [DISP:STAT OFF](#).
- While a message is displayed, information relating to the current instrument operation is not sent to the front panel display.
- The display text is unaffected by [*RST](#). It is cleared at power-on.

DISPlay:TEXT:CLEAr

Clears the text message from the display.

Parameter	Typical Return
(none)	(none)
Clear displayed message:	
DISP:TEXT:CLE	

- With **DISPlay ON**, DISP:TEXT:CLEAr returns the display to its normal mode.
- With **DISPlay OFF**, DISP:TEXT:CLEAr clears the message and the display remains disabled. To enable the display, send **DISPlay ON** or press the front panel **[Local]** key.
- The display text is unaffected by ***RST**. It is cleared at power-on.

DISPlay:VIEW {NUMeric|HISTogram|TCHart|METER}**DISPlay:VIEW?**

Specifies whether measurement data is displayed in numeric, histogram, trend chart (not available on the 34460A), or bar meter form.

Parameter	Typical Return
{NUMeric HISTogram TCHart METER}. Default: NUM.	HIST
Display histogram:	
DISP:VIEW HIST	

- The display is not turned on if the display state is OFF.
- This parameter is set to its default value after a Factory Reset (***RST**) or Instrument Preset (**SYSTem:PRESet**).

FORMat Subsystem

This subsystem applies only to the 34465A and 34470A.

Command Summary

[FORMat:BORDER](#)

[FORMat\[:DATA\]](#)

FORMat:BORDER {NORMal|SWAPped}

FORMat:BORDER?

Used for binary block transfers only. Selects the byte order for binary block transfers using [MEASure?](#), [READ?](#), [FETCh?](#), [DATA:REMOve?](#) and [R?](#).

Parameter	Typical Return
{NORMal SWAPped} (see bullet points below). Default: NORM.	NORM
Select the swapped byte order:	
FORMat:BORDER SWAP	

- Applies only to the 34465A and 34470A.
- In the *NORMal* byte order (default) the most-significant byte (MSB) of each data point is assumed first.
- In the *SWAPped* byte order the least-significant byte (LSB) of each data point is assumed first. Most PCs use the "swapped" byte order.
- The byte order setting is stored in non-volatile memory and does not change when power has been off. The default value is restored after a Factory Reset ([*RST](#)), or after an Instrument Preset ([SYSTEM:PRESet](#)).

FORMat[:DATA] {ASCIi|REAL} [, <length>]

FORMat[:DATA]?

Specifies the data format to be either ASCII or REAL. Affects the data format of the [MEASure?](#), [READ?](#), [FETCh?](#), [DATA:REMOve?](#) and [R?](#) commands only.

Parameter	Typical Return
<length> ASCIi: "9" or REAL: "64"	ASC,9
Specify the 64-bit REAL data format:	
FORM:DATA REAL,64 or FORM:DATA REAL	

- Applies only to the 34465A and 34470A.
- If ASCII is specified, numeric data is transferred as ASCII characters. The numbers are separated by commas as specified in IEEE 488.2. The `<length>` parameter is optional, but "9" is the default and only allowed value, and the instrument returns 9 significant digits (for example: +4.57553816E-05).
- If REAL is specified, numeric data is transferred as REAL binary data in IEEE 488.2 definite-length block format. The `<length>` parameter is optional, but "64" is the default and only allowed value. The byte order is controlled by [FORMat:BOrDer](#).

HCOPy Subsystem

The HCOPy subsystem produces display images ("screen shots").

Example

The following example captures and returns the display image in BMP format.

```
HCOP:SDUM:DATA:FORM BMP
HCOP:SDUM:DATA?
```

HCOPy:SDUMp:DATA?

Returns the front panel display image ("screen shot").

Parameter	Typical Return
(none)	<p>(A definite-length binary block containing the image.)</p> <p>A definite-length block allows data to be transmitted as a series of 8-bit data bytes. This is particularly useful for transferring large quantities of data or 8-bit extended ASCII codes.</p>
See Example .	

- The image format (PNG or BMP) is specified by [HCOPy:SDUMp:DATA:FORMat](#).

HCOPy:SDUMp:DATA:FORMat {PNG|BMP}

HCOPy:SDUMp:DATA:FORMat?

Specifies the format for images returned by [HCOPy:SDUMp:DATA?](#).

Parameter	Typical Return
{PNG BMP}. Default: PNG.	PNG or BMP
See Example .	

IEEE 488.2 Common Commands

These commands and queries are associated with the IEEE 488.2 standard.

Command Summary

[*CAL?](#)

[*CLS](#)

[*ESE](#)

[*ESR?](#)

[*IDN?](#)

[*LRN?](#)

[*OPC](#)

[*OPC?](#)

[*OPT?](#)

[*PSC](#)

[*RCL](#)

[*RST](#)

[*SAV](#)

[*SRE](#)

[*STB?](#)

[*TRG](#)

[*TST?](#)

[*WAI](#)

Standard Event Register

The following table describes the Standard Event Register.

Bit Number	Bit Name	Decimal Value	Definition
0	Operation Complete	1	All commands prior to and including *OPC have been executed.
1	Not Used	2	0 is returned.
2	Query Error	4	The instrument tried to read the output buffer but it was empty. Or, a new command line was received before a previous query has been read. Or, both the input and output buffers are full.
3	Device-Specific Error	8	A device-specific error, including a self-test error or calibration error, occurred (an error in the -300 range or any positive error has been generated). See SCPI Error Messages for the complete SCPI error message list.
4	Execution Error	16	An execution error occurred (an error in the -200 range has been generated).
5	Command Error	32	A command syntax error occurred (an error in the -100 range has been generated).
6	Not Used	64	0 is returned.
7	Power On	128	Power has been cycled since the last time the event register was read or cleared.

Status Byte Register

The following table describes the Status Byte Register.

Bit Number	Bit Name	Decimal Value	Definition
0	Not Used	1	(Reserved for future use)
1	Not Used	2	(Reserved for future use)
2	Error Queue	4	One or more errors have been stored in the Error Queue. Use SYSTem:ERRor? to read and delete errors.
3	Questionable Data Summary	8	One or more bits are set in the Questionable Data Register (bits must be enabled, see STATus:QUEStionable:ENABle).
4	Message Available	16	Data is available in the instrument's output buffer.
5	Standard Event Summary	32	One or more bits are set in the Standard Event Register (bits must be enabled, see *ESE).
6	Master Summary	64	One or more bits are set in the Status Byte Register and may generate a Request for Service (RQS). Bits must be enabled using *SRE .
7	Standard Operation Summary	128	One or more bits are set in the Standard Operation Register (bits must be enabled, see STATus:OPERation:ENABle).

***CAL?**

Calibration Query. Performs autocalibration (autocal) and returns the result.

Parameter	Typical Return
(none)	+0 (no error) +1 (cal error)
Perform autocalibration, return result: *CAL?	

- Autocalibration takes just a few seconds to complete.
- Autocalibration compensates for drift caused by time and temperature change in DC voltage and resistance measurements, and adjusts some aspects of other measurement functions.
- Following the autocalibration, the instrument returns to the instrument state that existed before the autocalibration.

***CLS**

Clear Status Command. Clears the event registers in all register groups. Also clears the error queue.

Parameter	Typical Return
(none)	(none)
Clear event register bits and error queue: *CLS	

***ESE <enable_value>**

***ESE?**

Event Status Enable Command and Query. Enables bits in the enable register for the [Standard Event Register](#) group. The selected bits are then reported to bit 5 of the Status Byte Register. An enable register defines which bits in the event register will be reported to the Status Byte register group. You can write to or read from an enable register.

NOTE For more information on the SCPI Status System, see [Status Subsystem Introduction](#).

Parameter	Typical Return
Decimal sum of the bits in the register, default 0. For example, to enable bit 2 (value 4), bit 3 (value 8), and bit 7 (value 128), the decimal sum would be 140 (4 + 8 + 128). Default: 0.	+48
Configure 100 DC voltage measurements and enable the generation of an SRQ when the measurements complete: <pre>*CLS *ESE 1 *SRE 32 CONF:VOLT:DC SAMP:COUN 100 INIT *OPC</pre>	

- Use [*PSC](#) to control whether the Standard Event enable register is cleared at power on. For example, [*PSC 0](#) preserves the enable register contents through power cycles.
- [*CLS](#) clears the event register, but not the enable register.
- The <enable> setting is nonvolatile; it does not change after a Factory Reset ([*RST](#)), Instrument Pre-set ([SYSTem:PRESet](#)), Status Preset ([STATus:PRESet](#)) or Clear Status ([*CLS](#)).

***ESR?**

Standard Event Status Register Query. Queries the event register for the [Standard Event Register](#) group.

An event register is a read-only register that latches events from the condition register. While an event bit is set, subsequent events corresponding to that bit are ignored.

Parameter	Typical Return
(none)	+24
Read the event register (bits 3 and 4 are set):	
*ESR?	

- In order to be reported to the Status Byte Register, the corresponding bits in the enable register must be enabled by [*ESE](#).
- Any or all conditions can be reported to the Standard Event summary bit through the enable register. To set the enable register mask, write a decimal value to the register using [*ESE](#).
- Once a bit is set, it remains set until cleared by reading the event register or by sending [*CLS](#) (clear status).

***IDN?**

Identification Query. Returns the instrument's identification string.

Parameter	Typical Return
(none)	(see below)
Return the instrument's identification string: *IDN?	

- **For firmware revisions prior to 2.0**, the identification string contains these four comma separated fields:

Manufacturer name, Model number, Serial number, Revision code

If [SYSTem:IDENtify DEFault](#) is set, the returned string has the following format:

Agilent Technologies,34460A,<Serial Number>,h.ff.ff-pp.pp-mm.mm-gg.gg-bb-fp
Agilent Technologies,34461A,<Serial Number>,h.ff.ff-pp.pp-mm.mm-gg.gg-bb-fp

If [SYSTem:IDENtify HP34401A](#) is set, the returned string has the following format:

HEWLETT-PACKARD,34401A,<Serial Number>,h.ff.ff-pp.pp-mm.mm-gg.gg-bb-fp

Where:

- h.** - Hardware revision
- ff.ff** - Main firmware revision
- pp.pp** - Front panel firmware revision
- mm.mm** - Measurement board firmware revision
- gg.gg** - Measurement board FPGA revision
- bb** - Measurement board revision
- fp** - Front panel board revision

- **For firmware revision 2.0 and later**, the identification string contains these four comma separated fields:

Manufacturer name, Model number, Serial number, Revision code

If **SYSTem:IDENtify DEFault** is set, the returned string has the following format:

Keysight Technologies,34460A,<Serial Number>,h.ff.ff-pp.pp-mm.mm-gg.gg-bb-fp
 Keysight Technologies,34461A,<Serial Number>,h.ff.ff-pp.pp-mm.mm-gg.gg-bb-fp
 Keysight Technologies,34465A,<Serial Number>,h.ff.ff-pp.pp-mm.mm-gg.gg-bb-fp
 Keysight Technologies,34470A,<Serial Number>,h.ff.ff-pp.pp-mm.mm-gg.gg-bb-fp

If **SYSTem:IDENtify AT34460A or AT34461A** is set, the returned string has the following format (34460A or 34461A only):

Agilent Technologies,34460A,<Serial Number>,h.ff.ff-pp.pp-mm.mm-gg.gg-bb-fp
 Agilent Technologies,34461A,<Serial Number>,h.ff.ff-pp.pp-mm.mm-gg.gg-bb-fp

If **SYSTem:IDENtify HP34401A** is set, the returned string has the following format:

HEWLETT-PACKARD,34401A,<Serial Number>,h.ff.ff-pp.pp-mm.mm-gg.gg-bb-fp

If **SYSTem:IDENtify AT34410A or AT34411A** is set, the returned string has the following format (34465A or 34470A only):

Agilent Technologies,34410A,<Serial Number>,h.ff.ff-pp.pp-mm.mm-gg.gg-bb-fp
 Agilent Technologies,34411A,<Serial Number>,h.ff.ff-pp.pp-mm.mm-gg.gg-bb-fp

Where:

h. - Hardware revision

ff.ff - Main firmware revision

pp.pp - Front panel firmware revision

mm.mm - Measurement board firmware revision

gg.gg - Measurement board FPGA revision

bb - Measurement board revision

fp - Front panel board revision

***LRN?**

Returns an ASCII string of all of the commands required to put the instrument into its current state.

Parameter	Typical Return
(none)	An ASCII string of SCPI commands, delimited with semicolons (";") between commands.
Return the learn string: *LRN?	

- Some parameters can be set with either [SENSe:]FREQuency or [SENSe:]PERiod versions of the same command. The *LRN string always returns the FREQuency version of the command, even if the parameter was set via the PERiod version. Similarly, parameters that can be set with RESistance or FRESistance versions of the same command always return the FRESistance version.

***OPC**

Sets "Operation Complete" (bit 0) in the Standard Event register at the completion of the current operation.

Parameter	Typical Return
(none)	(none)
Configure 100 DC voltage measurements and enable the generation of an SRQ when the measurements complete: *CLS *ESE 1 *SRE 32 CONF:VOLT:DC SAMP:COUN 100 INIT *OPC	

- Other commands may be executed before Operation Complete bit is set.
- The difference between *OPC and *OPC? is that *OPC sets a status bit when the operation completes, and *OPC? outputs "1" when the operation completes.

***OPC?**

Returns 1 to the output buffer after all pending commands complete. Other commands cannot be executed until this command completes.

Parameter	Typical Return
(none)	1
Configure 100 DC voltage measurements and return "1" when the measurements complete: CONF:VOLT:DC SAMP:COUN 100 INIT *OPC?	

- Use this command to synchronize your application with the instrument.
- The difference between *OPC and *OPC? is that *OPC sets a status bit when the operation completes, and *OPC? outputs "1" when the operation completes.

***OPT?**

Returns a string identifying any installed options.

Parameter	Typical Return
(none)	(see below)
Return the installed options: *OPT?	

- This query returns a string with the following format:

```
34460A: {GPB|0},{LAN|0},{SEC|0}
34461A: {GPB|0},{SEC|0}
34465A/70A: {GPB|0},{SEC|0},{DIG|0},{MEM|0}
```

A 0 is returned for options that are not installed. For example, a 34461A with only GPIB installed returns GPB,0. A 34460A with only GPB and SEC installed returns GPB,0,SEC.

- Options vary by model, as [shown here](#).

***PSC {0|1}**

***PSC?**

Power-On Status Clear. Enables (1) or disables (0) the clearing of certain enable registers at power on:

- Questionable Data Register ([STATus:QUEStionable:ENABle](#))
- Standard Operation Register ([STATus:OPERation:ENABle](#))
- Status Byte Condition Register ([*SRE](#))
- Standard Event Enable Register ([*ESE](#))

NOTE

The [*PSC](#) command does not affect the clearing of the condition or event registers, just the enable registers. For more information on the SCPI Status System, see [Status Sub-system Introduction](#).

Parameter	Typical Return
{0 1}. Default: 1	0 or 1
Disable power-on clearing of affected registers:	
*PSC 0	

***RCL {0|1|2|3|4}**

***SAV {0|1|2|3|4}**

Stores the current instrument state to, or recalls the instrument state from, the state file *STATE_<n>.sta* in the root folder of the internal flash file system, where <n> is the number specified.

Parameter	Typical Return
{0 1 2 3 4}	(none)
Store the instrument state to the state file <i>STATE_1.sta</i> in the root folder of the internal flash file system:	
*SAV 1	

- *SAV <n> is equivalent to [MMEMory:STORe:STATe](#) "INT:\STATE_<n>.sta".
- *RCL <n> is equivalent to [MMEMory:LOAD:STATe](#) "INT:\STATE_<n>.sta".
- The state file created by *SAV 0, called *STATE_0.sta*, resides in the root folder of the internal flash file system. It is overwritten with the power-down state of the instrument when power is cycled.
- The instrument state enable settings are stored in nonvolatile memory. They do not change when power has been off, after a Factory Reset ([*RST](#)) or after an Instrument Preset ([SYSTem:PRESet](#)).

***RST**

Resets instrument to [factory default state](#). This is similar to [SYSTem:PRESet](#). The difference is that *RST resets the instrument for SCPI operation, and SYSTem:PRESet resets the instrument for front panel operation. As a result, *RST turns the histogram and statistics off, and SYSTem:PRESet turns them on.

Parameter	Typical Return
(none)	(none)
Reset the instrument:	
*RST	

- Does not affect stored instrument states (see *SAV).

***SRE <enable_value>**

***SRE?**

Service Request Enable. Enables bits in the enable register for the [Status Byte Register](#) group. An enable register defines which bits in the event register will be reported to the Status Byte register group. You can write to or read from an enable register.

Parameter	Typical Return
Decimal sum of the bits in the register, default 0. For example, to enable bit 2 (value 4), bit 3 (value 8), and bit 7 (value 128), the decimal sum would be 140 (4 + 8 + 128). Default: 0.	+24
Enable bits 3 and 4 in the enable register:	
*SRE 24	

- To enable specific bits, specify the decimal value corresponding to the binary-weighted sum of the bits in the register. The selected bits are summarized in the "Master Summary" bit (bit 6) of the Status Byte Register. If any of the selected bits change from 0 to 1, the instrument generates a Service Request signal.
- [*CLS](#) clears the event register, but not the enable register. An event register is a read-only register that latches events from the condition register. While an event bit is set, subsequent events corresponding to that bit are ignored.
- [*PSC](#) (power-on status clear) determines whether Status Byte enable register is cleared at power on. For example, *PSC 0 preserves the enable register contents through power cycles.
- The Status Byte enable register is not cleared by [*RST](#).

***STB?**

Read Status Byte Query. Queries the condition register for the [Status Byte Register](#) group and returns a decimal value equal to the binary-weighted sum of all bits set in the register.

A condition register continuously monitors the state of the instrument. Condition register bits are updated in real time; they are neither latched nor buffered.

Parameter	Typical Return
(none)	+40
Read condition register (with bits 3 and 5 set); *STB?	

- Similar to a Serial Poll, but processed like any other instrument command. This register is read-only; bits are not cleared when read.
- Returns same result as a Serial Poll, but the "Master Summary" bit (bit 6) is not cleared by [*STB?](#).
- Power cycle and [*RST](#) clear all bits in the condition register.

***TRG**

Triggers the instrument if [TRIGger:SOURce BUS](#) is selected.

Parameter	Typical Return
(none)	(none)
Return five DC voltage measurements, using a software trigger to start the measurements: CONF:VOLT:DC SAMP:COUN 5 TRIG:SOUR BUS INIT *TRG FETCH? Typical Response: +1.00520000E+01, ... (5 measurements)	

- After setting the trigger source, you must send [INITiate](#) to place the DMM in the "wait-for-trigger" state. The [*TRG](#) command is not accepted unless the DMM is in the "wait-for-trigger" state.

***TST?**

Performs a basic self-test of the instrument and returns a pass/fail indication. The [TEST:ALL?](#) self-test is more comprehensive than the [*TST?](#) self-test.

Parameter	Typical Return
(none)	+0 (pass) or +1 (one or more tests failed)
Perform self-test: *TST?	

- The self-test takes just a few seconds to complete.
- If one or more tests fail, the query returns +1 and stores an error in the error queue. For a complete listing of the error messages related to self-test failures, see [Self-test Error Messages](#).
- Following the test, the instrument returns to the instrument state that existed before the self-test.

***WAI**

Configures the instrument's output buffer to wait for all pending operations to complete before executing any additional commands over the interface.

Parameter	Typical Return
(none)	(none)
Wait until all pending operations complete: *WAI	

- Configuration changes and measurements are considered pending operations. Therefore, *WAI causes these changes to occur and complete.

LXI Subsystem

This subsystem supports LAN eXtensions for Instrumentation (LXI) functionality.

Command Summary

[LXI:IDENtify\[:STATe\]](#)

[LXI:MDNS:ENABle](#)

[LXI:MDNS:HNAME\[:RESolved\]?](#)

[LXI:MDNS:SNAME:DESired](#)

[LXI:MDNS:SNAME\[:RESolved\]?](#)

[LXI:RESet](#)

[LXI:REStart](#)

LXI:IDENtify[:STATe] {ON|1|OFF|0}

LXI:IDENtify[:STATe]?

Shows or removes the LXI Web Identify indicator on the display.

Parameter	Typical Return
{ON 1 OFF 0}. Default: OFF.	0 (OFF) or 1 (ON)
Turn on the LXI Web Identify indicator:	
LXI:IDEN ON	

- The indicator helps you identify the device associated with the LAN address.
- Press the [**Local**] key or send ***RST** to turn off the indicator.

LXI:MDNS:ENABle {ON|1|OFF|0}

LXI:MDNS:ENABle?

Disables or enables the multicast Domain Name System (mDNS), which provides the capabilities of a DNS server for service discovery in a small network without a DNS server.

Parameter	Typical Return
{ON 1 OFF 0}. Default: ON.	0 (OFF) or 1 (ON)
Turn mDNS ON:	
LXI:MDSN:ENAB ON	

- This setting is non-volatile; it is not changed by power cycling, a Factory Reset (***RST**), or an Instrument Preset (**SYSTem:PRESet**).
- This parameter is set to its default value when the instrument is shipped from the factory and after **SYSTem:SECurity:IMMediate**.

LXI:MDNS:HNAME[:RESolved]?

Returns the resolved (unique) mDNS hostname in the form K-<model number>-<serial>-N , where <serial> is the last 5 digits of the instrument's serial number. The N is an integer appended if necessary to make the name unique. The desired name may be truncated, if necessary, to make room for the appended integer.

Parameter	Typical Return
(none)	"K-34460A-yyyyy", where yyyyy is the last five digits of the serial number.
Return the resolved mDNS hostname:	
LXI:MDNS:HNAME:RESolved?	

LXI:MDNS:SNAME:DESired "<name>"

LXI:MDNS:SNAME:DESired?

Sets the desired mDNS service name.

Parameter	Typical Return
Quoted string of up to 63 characters. Default: "Keysight <model number> Digital Multimeter - <serial>" where <serial> is the last 5 digits of the instrument's serial number	"Keysight 34460A Digital Multimeter - 98765"
Set the mDNS service name:	
LXI:MDNS:SNAM:DES "LAB1-DMM"	

- This setting is non-volatile; it is not changed by power cycling, a Factory Reset (***RST**), or an Instrument Preset (**SYSTem:PRESet**).
- This parameter is set to its default value when the instrument is shipped from the factory and after **SYSTem:SECurity:IMMediate**.

LXI:MDNS:SNAME[:RESolved]?

The resolved mDNS service name will be the desired service name (**LXI:MDNS:SNAME:DESired**), possibly with "<N>" appended. The N is an integer appended if necessary to make the name unique. The desired name may be truncated, if necessary, to make room for the appended integer.

Parameter	Typical Return
(none)	"Keysight 34461A Digital Multimeter - 00123"
Return resolved mDNS service name:	
LXI:MDNS:SNAME:RESolved?	

LXI:RESet

Resets LAN settings to a known operating state, beginning with DHCP, and clears the Web Interface password. If DHCP fails, it uses Auto-IP.

Parameter	Typical Return
(none)	(none)
Reset the LAN settings: LXI:RES	

- Depending on your network, the LAN interface may take several seconds to restart after this command is sent.
- If the LAN interface or specific LAN services (VXI-11, sockets, and so on) have been disabled by [SYSTem:COMMunicate:ENABle](#), you must separately re-enable the interface or services and cycle instrument power for the LAN to be operational.

LXI:REStart

Restarts the LAN with the current settings as specified by the [SYSTem:COMMunicate:LAN](#) commands.

Parameter	Typical Return
(none)	(none)
Restart the LAN interface: LXI:REST	

- Depending on your network, the LAN interface may take several seconds to restart after this command is sent.
- If the LAN interface or specific LAN services (VXI-11, sockets, and so on) have been disabled by [SYSTem:COMMunicate:ENABle](#), you must separately re-enable the interface or services and cycle instrument power for the LAN to be operational.

MEASure Subsystem

The MEASure queries are the easiest way to program measurements because they always use default measurement parameters. You set the function, range, and resolution in one command, but you cannot change other parameters from their default values. The results are sent directly to the instrument's output buffer.

NOTE A MEASure query is functionally equivalent to sending CONFigure followed immediately by **READ?**. The difference is that CONFigure commands allow you to change parameters between the CONFigure and the READ?

Command Summary

[MEASure:CAPacitance?](#)

[MEASure:CONTInuity?](#)

[MEASure:CURRent:{AC|DC}?](#)

[MEASure:DIODe?](#)

[MEASure:{FREQuency|PERiod}?](#)

[MEASure:{RESistance|FRESistance}?](#)

[MEASure:TEMPerature?](#)

[MEASure\[:VOLTage\]:{AC|DC}?](#)

[MEASure\[:VOLTage\]\[:DC\]:RATio?](#)

Default Settings for MEASure?

With the MEASure? queries, you can select the function, range and resolution in one command. All other parameters are set to their default values (below).

Measurement Parameter	Default Setting
AC Input Filter (bandwidth)	20 Hz (medium filter)
Autozero	OFF if resolution setting results in NPLC < 1 ON if resolution setting results in NPLC ≥ 1
Range	AUTO (including voltage range for frequency and period measurements)
Samples per Trigger	1 sample
Trigger Count	1 trigger
Trigger Delay	Automatic delay
Trigger Source	Immediate
Trigger Slope	NEGative
Math Functions	Disabled. Other parameters are unchanged.
Per-function Null State	Disabled

Using the MEASure? Query

The following example configures DC voltage measurements, internally triggers the instrument to take a measurement, and reads the measurement. The default range (autorange) and resolution (10 PLC) are used for the measurement.

```
MEAS:VOLT:DC?
```

Typical Response: +4.23450000E-03

The following example configures the instrument for 2-wire resistance measurements, triggers the instrument to take a measurement, and reads the measurement. The 1 k Ω range is selected with 0.1 Ω resolution.

```
MEAS:RES? 1000,0.1
```

Typical Response: +3.27150000E+02

MEASure:CAPacitance? [{<range>|AUTO|MIN|MAX|DEF} [, {<resolution>|MIN|MAX|DEF}]]

Sets all measurement parameters and trigger parameters to their [default values](#) for capacitance measurements and immediately triggers a measurement. The results are sent directly to the instrument's output buffer.

Parameter	Typical Return
<range>: {1 nF 10 nF 100 nF 1 μF 10 μF 100 μF}. Default: AUTO.	(none)
<resolution>: optional and ignored; fixed at 4½ digits.	
Configure capacitance measurements. Then make and read one measurement: MEAS:CAP? Typical Response: +3.01534021E-10	

- You can let autoranging select the measurement range, or you can manually select a fixed range. Autoranging conveniently selects the range for each measurement based on the input signal. For fastest measurements, use manual ranging (autoranging may require additional time for range selection).
- Autoranging (AUTO or DEFault), will generate an error if you specify a <resolution> because the instrument cannot accurately resolve the integration time (especially if the input continuously changes). If your application requires autoranging, specify DEFault for the <resolution> or omit the <resolution> altogether.
- Autoranging goes down a range at less than 10% of range and up a range at greater than 120% of range. For capacitance measurements only, when autorange is off, the instrument does not report an overload for readings greater than 120% of range. Overload only occurs when the algorithm times out because the applied capacitance is too large for the algorithm to measure. If you apply a DC voltage or a short to the input terminals in capacitance measurement mode, the instrument reports an overload.
- If the input signal is greater than can be measured on the specified manual range, the instrument displays the word *Overload* on front panel and returns "9.9E37" from the remote interface.

MEASure:CONTInuity?

Sets all measurement parameters and trigger parameters to their default values for continuity test and immediately triggers a measurement. The results are sent directly to the instrument's output buffer.

Parameter	Typical Return
(none)	(none)
Configure the instrument for continuity measurements. Then make and read one measurement: MEAS:CONT? Typical Response: +1.32130000E-02	

- The range and resolution are fixed at 1 kΩ for continuity tests (a 2-wire resistance measurement).
- The instrument beeps (if the beeper is enabled) for each measurement less than or equal to the continuity threshold ($\leq 10 \Omega$), and the actual resistance measurement appears on the display.
- From 10 Ω to 1.2 kΩ, the instrument displays the actual resistance measurement with no beep. Above 1.2 kΩ, the instrument displays "OPEN" with no beep.
- The FETCh?, READ?, and MEASure:CONTInuity? queries return the measured resistance, regardless of its value.

MEASure:CURRent:{AC|DC}? [{<range>|AUTO|MIN|MAX|DEF} [, {<resolution>|MIN|MAX|DEF}]]

Sets all measurement parameters and trigger parameters to their [default values](#) for AC or DC current measurements and immediately triggers a measurement. The results are sent directly to the instrument's output buffer.

Parameter	Typical Return
<range>: {100 μ A 1 mA 10 mA 100 mA 1 A 3 A 10 A}. Default: AUTO (autorange).	(none)
<resolution> (AC): optional and ignored; fixed at 6½ digits. <resolution> (DC): See Resolution Table or Range, Resolution and NPLC . The default is equivalent to 10 PLC.	
Specify <resolution> in the measurement's units (V, A, Hz, Ω , and so on).	
Configure AC current measurements using the 1 A range. Then make and read one measurement: MEAS:CURR:AC? 1 Typical Response: +8.54430000E-01	

- You can let autoranging select the measurement range, or you can manually select a fixed range. Autoranging conveniently selects the range for each measurement based on the input signal. For fastest measurements, use manual ranging (autoranging may require additional time for range selection).
- Autoranging (AUTO or DEFault), will generate an error if you specify a <resolution> because the instrument cannot accurately resolve the integration time (especially if the input continuously changes). If your application requires autoranging, specify DEFault for the <resolution> or omit the <resolution> altogether.
- Autoranging goes down a range at less than 10% of range and up a range at greater than 120% of range.
- If the input signal is greater than can be measured on the specified manual range, the instrument displays the word *Overload* on front panel and returns "9.9E37" from the remote interface.

MEASure:DIODe?

Sets all measurement parameters and trigger parameters to their [default values](#) for diode test measurements and immediately triggers a measurement. The results are sent directly to the instrument's output buffer.

Parameter	Typical Return
(none)	(none)
Configure, make, and read a default diode measurement:	
MEAS:DIOD?	
Typical Response: +1.32130000E-01	

- The range and resolution are *fixed* for diode tests: the range is 1 VDC (with a 1 mA current source output).
- The voltage is displayed on the front panel if it is between 0 and 5.05 V. The instrument beeps when the signal transitions into the range between 0.3 and 0.8 V (unless beeper is disabled). If the signal exceeds 5.05 V, the front panel shows "OPEN", and the value returned from SCPI is 9.9E37.
- The [FETCh?](#), [READ?](#), and [MEASure:DIODe?](#) queries return the measured voltage, regardless of its value.

MEASure:{FREQuency|PERiod}? [{<range>|MIN|MAX|DEF} [, {<resolution>|MIN|MAX|DEF}]]

Sets all measurement parameters and trigger parameters to their **default values** for frequency or period measurements and immediately triggers a measurement. The results are sent directly to the instrument's output buffer.

Parameter	Typical Return
<range>: 3 Hz to 300 kHz. Default: 20 Hz. for FREQuency <range>: 3.33 μs to 333.33 ms. Default: 50 ms (PERiod).	(none)
<resolution>: See table below. Specify <resolution> in the measurement's units (V, A, Hz, Ω, and so on).	
Configure frequency measurements using the default aperture. Then make and read one measurement: MEAS:FREQ? Typical Response: +1.32130000E+03	

- The 1 mS aperture applies only to the 34465A and 34470A.
- The frequency or period <range> parameter is required only to specify the measurement resolution parameter. It is not necessary to send a new command for each new frequency or period to be measured. The <range> and <resolution> parameters affect the aperture (gate time) as follows:

Resolution (34460A/61A)	Resolution (34465A/70A)	Aperture
Not Applicable	100 ppm × <range> (MAXimum)	1 ms
100 ppm × <range> (MAXimum)	10 ppm × <range> (DEFault)	10 ms
10 ppm × <range> (DEFault)	1 ppm × <range>	100 ms
1 ppm × <range> (MINimum)	0.1 ppm × <range> (MINimum)	1 s

- The input signal for frequency or period measurements has an *AC voltage* component. By default, this command uses autorange to select the voltage range.
- With no signal applied, 0 is returned.

MEASure:{RESistance|FRESistance}? [{<range>|AUTO|MIN|MAX|DEF} [, {<resolution>|MIN|MAX|DEF}]]

Sets all measurement and trigger parameters to their [default values](#) for 4-wire resistance (FRESistance) or 2-wire (RESistance) measurements, and immediately triggers a measurement. The results are sent directly to the instrument's output buffer.

Parameter	Typical Return
<range>: 100 Ω, 1 kΩ, 10 kΩ, 100 kΩ, 1 MΩ, 10 MΩ, 100 MΩ, 1 GΩ, AUTO, or DEFault. Default: AUTO.	(none)
<resolution>: See Resolution Table or Range, Resolution and NPLC . The default is equivalent to 10 PLC. Specify <resolution> in the measurement's units (V, A, Hz, Ω, and so on).	
Configure 4-wire resistance measurements using the 100 Ω range with default resolution. Then make and read one measurement: MEAS:FRES? 100 Typical Response: +8.54530000E+01	

- The 1 GΩ range applies only to the 34465A and 34470A.
- You can let autoranging select the measurement range, or you can manually select a fixed range. Autoranging conveniently selects the range for each measurement based on the input signal. For fastest measurements, use manual ranging (autoranging may require additional time for range selection).
- Autoranging (AUTO or DEFault), will generate an error if you specify a <resolution> because the instrument cannot accurately resolve the integration time (especially if the input continuously changes). If your application requires autoranging, specify DEFault for the <resolution> or omit the <resolution> altogether.
- Autoranging goes down a range at less than 10% of range and up a range at greater than 120% of range.
- If the input signal is greater than can be measured on the specified manual range, the instrument displays the word *Overload* on front panel and returns "9.9E37" from the remote interface.

MEASure:TEMPerature? [{FRTD|RTD|FTHermistor|THERmistor|TCouple|DEFault} [, {<type>|DEFault} [,1 [, {<resolution>|MIN|MAX|DEF}]]]]

Sets all measurement parameters and trigger parameters to their [default values](#) for temperature measurements and immediately triggers a measurement. The results are sent directly to the instrument's output buffer.

Parameter	Typical Return
<probe_type>: {FRTD RTD FTHermistor THERmistor TCouple}. Default: FRTD.	(none)
<type>: 85 (only possible value for RTD/FRTD), 5000 (only possible value for THERmistor/FTHermistor), or E, J, K, N, R, T (TCouple).	
<resolution>: See Resolution Table or Range, Resolution and NPLC . The default is equivalent to 10 PLC.	
Configure a 4-wire RTD measurement with default resolution. Then make and read one measurement: MEAS:TEMP? FRTD,85 Typical Response: +2.12320000E+01	

- Thermocouple measurements (TC) apply only to the 34465A and 34470A.
- For temperature measurements, the instrument internally selects the range; you cannot select the range to be used. The range ("1" is the only allowed value) is used only in conjunction with resolution to determine NPLC.
- The <resolution> parameter only determines the integration time; it does not specify the resolution of the temperature measurement. This parameter is optional; however, if you specify <resolution>, you must also specify "1" as the implied range parameter. For example: CONF:TEMP RTD,85,1,0.000001 selects the 10 PLC integration time on the 34461A.
- To change temperature units, use [UNIT:TEMPerature](#).
- For RTD and thermistor measurements, the instrument autoranges to the correct range for the transducer resistance measurement. For thermocouple measurements, the 100 mV range is selected.
- For thermocouple measurements, the internal reference is selected. See [SENSe:TEMPerature:TCouple:RJUNction:TYPE](#).
- If the input signal is greater than can be measured on the specified manual range, the instrument displays the word *Overload* on front panel and returns "9.9E37" from the remote interface.

MEASure[:VOLTage]:{AC|DC}? [{<range>|AUTO|MIN|MAX|DEF} [, {<resolution>|MIN|MAX|DEF}]]

Sets all measurement parameters and trigger parameters to their [default values](#) for AC or DC voltage measurements and immediately triggers a measurement. The results are sent directly to the instrument's output buffer.

WARNING The maximum range parameter (MAX) is 1000 V. However, the SAFETY LIMIT on the front and rear HI/LO input terminals is 750 VAC (rms). The rms voltage is waveform dependent. A sine wave is limited to 750 VAC (rms), but a 1000 Vpk square wave is safe. Connection to AC mains power is further limited to CAT II (300 V). See [Safety and Regulatory Information](#) for more information on the safety features and the safe operation of this instrument.

Parameter	Typical Return
<range>: 100 mV, 1 V, 10 V, 100 V, 1000 V, AUTO (default) or DEFault	(none)
<resolution> (AC): optional and ignored; fixed at 6½ digits.	
<resolution> (DC): See Resolution Table or Range, Resolution and NPLC . The default is equivalent to 10 PLC. Specify <resolution> in the measurement's units (V, A, Hz, Ω, and so on).	
Configure DC voltage measurements using the 10 V range with 1 mV resolution. Then make and read one measurement: MEAS:VOLT:DC? 10,0.001 Typical Response: +8.54530000E+01	

- You can let autoranging select the measurement range, or you can manually select a fixed range. Autoranging conveniently selects the range for each measurement based on the input signal. For fastest measurements, use manual ranging (autoranging may require additional time for range selection).
- Autoranging (AUTO or DEFault), will generate an error if you specify a <resolution> because the instrument cannot accurately resolve the integration time (especially if the input continuously changes). If your application requires autoranging, specify DEFault for the <resolution> or omit the <resolution> altogether.
- Autoranging goes down a range at less than 10% of range and up a range at greater than 120% of range.
- If the input signal is greater than can be measured on the specified manual range, the instrument displays the word *Overload* on front panel and returns "9.9E37" from the remote interface.

MEASure[:VOLTage][:DC]:RATio? [{<range>|AUTO|MIN|MAX|DEF} [, {<resolution>|MIN|MAX|DEF}]]

Sets all measurement parameters and trigger parameters to their [default values](#) for DC voltage ratio measurements and immediately triggers a measurement. The results are sent directly to the instrument's output buffer.

To calculate a ratio, the instrument measures a DC reference voltage applied to the *Sense* terminal and the DC signal voltage applied to the *Input* terminals. It then uses the formula:

$$\text{Ratio} = \text{DC signal voltage} / \text{DC reference voltage}$$

Parameter	Typical Return
<range>: 100 mV, 1 V, 10 V, 100 V, 1000 V, AUTO (default) or DEFault	(none)
<resolution>: See Resolution Table or Range, Resolution and NPLC . The default is equivalent to 10 PLC.	
Configure DC voltage ratio measurements using the 100 V range with 1 mV resolution. Then make and read one measurement:	
MEAS:VOLT:DC:RAT? 100,0.001	
Typical Response: +4.27150000E+00	

- The *Sense* terminals have a maximum measurable input of ±12 VDC. Autoranging is automatically selected for reference voltage measurements on the *Sense* terminals.
- The *Input LO* and *Sense LO* terminals must have a common reference and cannot have a voltage difference greater than ±2 V.
- The specified measurement range applies only to the signal connected to the *Input* terminals. The signal on the *Input* terminals can be any DC voltage up to 1,000 V.
- For the *Input* terminals, you can allow the instrument to select the measurement range by autoranging or you can select a fixed range using *manual ranging*. Autoranging decides which range to use for each measurement based on the input signal. For faster measurements, use manual ranging on each measurement (additional time is required for autoranging to select a range).
- Autoranging (AUTO or DEFault), will generate an error if you specify a <resolution> because the instrument cannot accurately resolve the integration time (especially if the input continuously changes). If your application requires autoranging, specify DEFault for the <resolution> or omit the <resolution> altogether.
- Autoranging goes down a range at less than 10% of range and up a range at greater than 120% of range.
- If the input signal is greater than can be measured on the specified manual range, the instrument displays the word *Overload* on front panel and returns "9.9E37" from the remote interface.

MMEMory Subsystem – General Purpose File Management

The MMEMory subsystem's general purpose file management commands are listed below. The MMEMory subsystem also includes two other types of commands:

[STATe and PREFerence File Management](#)

[Data Transfer](#)

Commands and Queries

[MMEMory:CATalog\[:ALL\]?](#)

[MMEMory:CDIRectory](#)

[MMEMory:COPI](#)

[MMEMory:DElete](#)

[MMEMory:MDIRectory](#)

[MMEMory:MOVE](#)

[MMEMory:RDIRectory](#)

Folder and file formats

Many MMEMory commands refer to folders and files. These have specific structures, described below.

Format for a <folder>

- The format for <folder> is "[[<drive>:]<path>]", where <drive> can be INTernal or USB, and <path> is a folder path, and <filespec> specifies a subset of files.
- INTernal specifies the internal flash file system. USB specifies a front panel USB storage device.
- If <drive> is specified, <path> is interpreted as an absolute folder path. Absolute paths begin with "\" or "/" and start at the root folder of <drive>.
- If <drive> is omitted, <path> is relative to the folder specified by [MMEMory:CDIRectory](#). Relative paths must NOT begin with \ or /.
- Folder and file names cannot contain the following characters: \ / : * ? " < > |
- The <folder> parameter cannot exceed 240 characters.
- The specified folder must exist and cannot be marked as hidden or system. The exception is [MMEMory:MDIRectory](#), which creates a folder. For MMEMory:MDIRectory, all folder levels above the new one must exist.

Format for a <file>

- The format for a file name is "[[<drive>:]<path>]<file_name>", where <drive> can be INTernal or USB, and <path> is a folder path.
- INTernal specifies the internal flash file system. USB specifies a front panel USB storage device.
- If <drive> is specified, <path> is interpreted as an absolute folder path. Absolute paths begin with "\" or "/" and start at the root folder of <drive>.
- If <drive> is omitted, <path> is relative to the folder specified by [MMEMory:CDIRectory](#). Relative paths must NOT begin with \ or /.
- Folder and file names cannot contain the following characters: \ / : * ? " < > |
- The combination of folder and file name cannot exceed 240 characters.

MMEMory:CATalog[:ALL]? [<folder>[<filespec>]]

Returns a list of files in the specified folder.

Parameter	Typical Return
Any valid folder name ; defaults to folder selected by MMEMory:CDIRectory	+1000000000,+327168572, "command.exe,,375808", "MyDCVMeas.sta,STAT,8192",MyData.csv,ASC,11265"
List all files in the folder MyData on the front panel USB storage device: MMEM:CAT? "USB:\MyData" List all state files in the root directory of internal memory: MMEM:CAT? "INT:*.sta"	

- If <filespec> is omitted or is *.* , the command or query acts on all files. You can also use the * as a generic wildcard: *.sta, abc*.* , and so on.
- The catalog takes the following form:

<mem_used>,<mem_free>{,"<file listing>"}

The instrument returns two numbers and a string for each file in the folder. The first number is the number of bytes used on the drive. The second indicates the number of bytes available. Each <file listing> is in the format "<file_name>,<file_type>,<file_size>" (including the quotation marks), where <file_name> is the name of the file including file extension, if any; <file_type> is either STAT for STATE (.sta) files, ASC for DATA (.csv) files, PREF for PREFERENCE (.prf) files, FOLD for folders, or null for all other file extensions; <file_size> is the file size in bytes.

- If no files exist, only <mem_used>,<mem_free> is returned.
- Because the instrument uses a small amount of space in the flash file system for internal use, the <mem_used> value is never zero.

MMEMory:CDIRectory <folder>
MMEMory:CDIRectory?
MMEMory:MDIRectory <folder>
MMEMory:RDIRectory <folder>

MMEMory:CDIRectory selects the default folder for MMEMory subsystem commands. This folder must exist and is used when folder or file names do not include a drive and folder name. They query returns the current default folder.

MMEMory:MDIRectory makes a new directory (folder) on the mass storage medium.

MMEMory:RDIRectory removes a directory (folder) on the mass storage medium.

Parameter	Typical Return
Any directory name, including the mass storage unit specifier. Default INT:\ Make and remove a new directory named "test" on the internal mass memory system : MMEM:MDIR "test" MMEM:RDIR "test" Select the \BACKUP folder on the internal flash file system as the default folder: MMEM:CDIR "INT:\BACKUP" Return the default folder for MMEMory subsystem commands: MMEM:CDIR?	"INT:\BACKUP"

- This parameter is set to its default value after a Factory Reset (***RST**) or Instrument Preset (**SYSTEM:PRESet**).
- You can only remove an empty folder. Otherwise, the instrument generates a "Directory not empty" error.

MMEMory:COPY <file1>,<file2>

Copies <file1> to <file2>. Each file name must include the file extension.

Parameter	Typical Return
Any valid file name (both files)	(none)
Copy state file from the root directory to the folder "Backup" on the internal flash file system : MMEM:COPY "INT:\MyVoltMeas.sta", "INT:\Backup"	

- The source file and folder must exist and cannot be marked as hidden or system.
- The destination folder must exist and cannot be marked as hidden or system.
- If the destination file exists, it will be overwritten, unless marked as hidden or system.
- To copy a file to a file of the same name in a different folder, specify just the <drive> and/or <path> for <destination>.

MMEMory:DELeTe {<file>|<filespec>}

Deletes a file. To delete a folder, use MMEMory:RDIRectory.

Parameter	Typical Return
Any valid file name , including file extension, or a <filespec>, as described below.	(none)
Delete a file from the root directory of the internal flash file system: MMEM:DEL "INT:\MySetup.sta"	

- A <filespec> may include the * as a wildcard character: *.bmp, *.sta, abc*.*, and so on.
- The specified folder must exist and cannot be marked as hidden or system.
- [SYSTEM:SECurity:IMMediate](#) deletes and sanitizes all files.

MMEMory:MOVE <file1>,<file2>

Moves and/or renames <file1> to <file2>. Each file name must include the file extension.

Parameter	Typical Return
Any valid file name (both files)	(none)
Move the specified state file from the currently selected default directory to the folder "Backup" on the internal flash file system: MMEM:MOVE "MyVoltMeas.sta","INT:\Backup"	

- To rename a file, specify the same folder for <file1> and <file2>.
- To move a file to a file of the same name in a different folder, you can specify just the <drive>:<path> for <file2>.

MMEMory Subsystem - STATE and PREFERence Files

These MMEMory subsystem commands save and load instrument states (state files) and preferred settings for non-volatile parameters (preference files). In general, state files store volatile settings associated with measurements. Preferences are non-volatile parameters associated with the instrument, but not any specific measurement. The following table summarizes what information is in each file.

State File	Preference File
<p>State Files for the 34460A/61A/65A/70A have this information:</p> <p>Active measurement function</p> <p>Ranges</p> <p>Integration time/resolution (NPLC)</p> <p>Auto range</p> <p>Auto zero</p> <p>Auto impedance (Input Z)</p> <p>AC bandwidth</p> <p>Trigger and sample settings</p> <p>Math settings (enables, null value(s), limits, ...)</p> <p>Data threshold for status bit</p> <p>VM Comp slope (Voltmeter Complete)</p> <p>Temperature units</p> <p>Default file system directory</p> <p>Display selection and settings (numeric, meter, histogram, trend chart, ...)</p> <p>Numeric front panel digit masking</p> <p>DBM reference resistance</p> <p>State Files for the 34465A/70A have this additional information:</p> <p>Binary/ASCII data format and byte order</p> <p>Trend chart and histogram display settings</p> <p>Data Log and Digitize mode settings</p> <p>Temperature probe settings</p> <p>Thermocouple reference junction offset adjustment</p>	<p>Preference Files for the 34460A/61A/65A/70A have this information:</p> <p>I/O enables, addresses, settings; mDNS settings</p> <p>Display brightness</p> <p>Screen saver enable, brightness</p> <p>Numeric separator (comma, space, none) and decimal point symbol</p> <p>Beeper and key click enable</p> <p>Help language</p> <p>Power-on status clear enable, status enables, transition filters</p> <p>Power-on state (*RST, user-defined, last)</p> <p>SCPI ID (string returned by *IDN)</p> <p>Power-on message text</p> <p>Color Scheme (A/B)</p> <p>Label enable, text</p> <p>Preference Files for the 34465A/70A have this additional information:</p> <p>Data Log mode file format settings</p> <p>Thermocouple reference junction offset adjustment</p>

The MMEMory subsystem also includes two other types of commands:

[General Purpose File Management](#)

[Data Transfer](#)

Command Summary

[MMEMory:LOAD:PREferences](#)

[MMEMory:STORe:PREferences](#)

[MMEMory:LOAD:STATe](#)

[MMEMory:STORe:STATe](#)

[MMEMory:STATe:RECall:AUTO](#)

[MMEMory:STATe:RECall:SElect](#)

[MMEMory:STATe:VALid?](#)

Folder and file formats

Many MMEMory commands refer to folders and files. These have specific structures, described below.

Format for a <folder>

- The format for <folder> is "[[<drive>:]<path>]", where <drive> can be INTernal or USB, and <path> is a folder path, and <filespec> specifies a subset of files.
- INTernal specifies the internal flash file system. USB specifies a front panel USB storage device.
- If <drive> is specified, <path> is interpreted as an absolute folder path. Absolute paths begin with "\" or "/" and start at the root folder of <drive>.
- If <drive> is omitted, <path> is relative to the folder specified by [MMEMory:CDIRectory](#). Relative paths must NOT begin with \ or /.
- Folder and file names cannot contain the following characters: \ / : * ? " < > |
- The <folder> parameter cannot exceed 240 characters.
- The specified folder must exist and cannot be marked as hidden or system. The exception is [MMEMory:MDIRectory](#), which creates a folder. For MMEMory:MDIRectory, all folder levels above the new one must exist.

Format for a <file>

- The format for a file name is "[[<drive>:]<path>]<file_name>", where <drive> can be INTernal or USB, and <path> is a folder path.
- INTernal specifies the internal flash file system. USB specifies a front panel USB storage device.
- If <drive> is specified, <path> is interpreted as an absolute folder path. Absolute paths begin with "\" or "/" and start at the root folder of <drive>.
- If <drive> is omitted, <path> is relative to the folder specified by [MMEMory:CDIRectory](#). Relative paths must NOT begin with \ or /.
- Folder and file names cannot contain the following characters: \ / : * ? " < > |
- The combination of folder and file name cannot exceed 240 characters.

Mass Memory (MMEMory) and State Storage

States saved by the front panel can be accessed from remote, and vice versa. For example, configure the instrument as desired and insert a USB drive into the front panel. Then enter the following commands. If you do not have a USB drive change "USB:\\" to "INT:\\" to use the instrument's internal flash drive instead.

```
MMEMory:CDIRectory "USB:\\"
MMEMory:MDIRectory "States"
MMEMory:STORe:STATE "USB:\States\State1"
```

To return to this state at any time:

```
MMEMory:LOAD:STATE "USB:\States\State1"
```

You can also recall a state file from the front panel by pressing [Utility] > Store/Recall.

MMEMory:LOAD:PREFerences <file>

MMEMory:STORe:PREFerences <file>

LOAD: Reboots the instrument and loads the nonvolatile I/O settings and user preferences from a file. The specified file cannot be empty or marked as hidden or system.

STORE: Stores nonvolatile I/O settings and user preferences to a file. If the destination file exists, it will be overwritten, unless marked as hidden or system.

CAUTION When loading a preferences file that specifies a static IP address, be careful that this does not result in two instruments with the same IP address on your LAN. This could cause LAN configuration errors on both instruments.

Parameter	Typical Return
Any valid file name The .prf file extension is optional. If you do not include this extension, the instrument firmware will automatically append it.	(none)
Stores the current nonvolatile I/O settings and user preferences into the specified file: MMEM:STOR:PREF "INT:\MyPreferences"	
Load nonvolatile I/O settings and user preferences from the specified file: MMEM:LOAD:PREF "INT:\MyPreferences"	

- See the [State File/Preferences File table](#) for a listing of the information contained in each file.
- The specified folder must exist and cannot be marked as hidden or system.

MMEMory:LOAD:STATe <filename>

MMEMory:STORe:STATe <filename>

Loads an instrument state from a state file or saves the current instrument state to a state file. The file name optionally includes the folder name and the .sta file extension. If you do not include this extension, the instrument firmware will automatically append it.

Parameter	Typical Return
Any valid file name	(none)
Store the current instrument state to the specified state file in the root directory of the internal flash file system:	
MMEM:STOR:STAT "INT:\MySetup"	
Load the instrument state from MySetup.sta saved by the previous command:	
MMEM:LOAD:STAT "INT:\MySetup.sta"	

- See the [State File/Preferences File table](#) for a listing of the information contained in each file.
- The specified folder must exist and cannot be marked as hidden or system.
- The specified file cannot be empty or marked as hidden or system.
- The state file created by *SAV 0, called STATE_0.sta, resides in the root folder of the internal flash file system. It is overwritten with the power-down state of the instrument when power is cycled.

MMEMory:STATe:RECall:AUTO {ON|1|OFF|0}

MMEMory:STATe:RECall:AUTO?

Disables or enables the automatic recall of a specific stored instrument state at power-on. Specify ON to automatically recall the power-down state file (STATE_0 in the root folder of the internal flash file system) or a user-specified state file (MMEMory:STATe:RECall:SElect). Select "OFF" to issue a Factory Reset (***RST**) at power-on.

Parameter	Typical Return
{ON 1 OFF 0}. Default: ON.	0 (OFF) or 1 (ON)
Select the power-down state to be used at power-on.	
MMEM:STAT:REC:SEL "INT:\STATE_0"	
MMEM:STAT:REC:AUTO ON	
Save the current state into a file in the root directory of the internal flash file system and load it at power-on:	
MMEM:STOR:STAT "INT:\MyVoltMeas"	
MMEM:STAT:REC:SEL "INT:\MyVoltMeas"	
MMEM:STAT:REC:AUTO ON	

- When shipped from the factory, the instrument is configured to automatically recall the power-down state file when power is restored.
- This setting is non-volatile; it is not changed by power cycling, a Factory Reset (***RST**), or an Instrument Preset ([SYSTEM:PRESet](#)).

MMEMory:STATe:RECall:SElect <file>
MMEMory:STATe:RECall:SElect?

Selects which instrument state to use at power-on if the automatic recall mode is enabled ([MMEMory:STATe:RECall:AUTO ON](#)). If the automatic recall mode is disabled ([MMEMory:STATe:RECall:AUTO OFF](#)), a Factory Reset ([*RST](#)) is issued at power-on.

Parameter	Typical Return
Any valid file name	"INT:\MyVoltMeas"
Select the power-down state to be used at power-on. MMEM:STAT:REC:SEL "INT:\STATE_0" MMEM:STAT:REC:AUTO ON Save the current state into a file in the root directory of the internal flash file system and load it at power-on: MMEM:STOR:STAT "INT:\MyVoltMeas" MMEM:STAT:REC:SEL "INT:\MyVoltMeas" MMEM:STAT:REC:AUTO ON	

- The specified folder must exist and cannot be marked as hidden or system.
- The state file created by *SAV 0, called STATE_0.sta, resides in the root folder of the internal flash file system. It is overwritten with the power-down state of the instrument when power is cycled.
- When shipped from the factory, the instrument is configured to automatically recall the power-down state file when power is restored.
- This setting is non-volatile; it is not changed by power cycling, a Factory Reset ([*RST](#)), or an Instrument Preset ([SYSTEM:PRESet](#)).

MMEMory:STATe:VALid? <file>

Returns 1 if the specified state file exists and contains a valid state file. Returns 0 otherwise.

Parameter	Typical Return
Any valid file name	1
Return the status of MyState.sta in the root folder of the internal flash file system. MMEM:STAT:VAL? "INT:\MyState.sta"	

- The specified folder must exist and cannot be marked as hidden or system.
- The specified file cannot be empty or marked as hidden or system.
- Use this query before sending [*RCL](#) or [MMEMory:LOAD:STATe](#) to determine whether a state has been stored in the file.

MMEMemory Subsystem - Data Transfer Commands

These commands transfer files into and out of the instrument's mass memory.

The MMEMemory subsystem also includes two other types of commands:

[General Purpose File Management](#)

[STATE and PREFERENCE File Management](#)

Command Summary

[MMEMemory:DOWNload:DATA](#)

[MMEMemory:DOWNload:FNAME](#)

[MMEMemory:FORMat:READing:CSEParator](#)

[MMEMemory:FORMat:READing:INFormation](#)

[MMEMemory:FORMat:READing:RLIMit](#)

[MMEMemory:STORe:DATA](#)

[MMEMemory:UPLoad?](#)

Folder and file formats

Many MMEMory commands refer to folders and files. These have specific structures, described below.

Format for a <folder>

- The format for <folder> is "[[<drive>:]<path>]", where <drive> can be INTERNAL or USB, and <path> is a folder path, and <filespec> specifies a subset of files.
- INTERNAL specifies the internal flash file system. USB specifies a front panel USB storage device.
- If <drive> is specified, <path> is interpreted as an absolute folder path. Absolute paths begin with "\" or "/" and start at the root folder of <drive>.
- If <drive> is omitted, <path> is relative to the folder specified by [MMEMory:CDIRectory](#). Relative paths must NOT begin with \ or /.
- Folder and file names cannot contain the following characters: \ / : * ? " < > |
- The <folder> parameter cannot exceed 240 characters.
- The specified folder must exist and cannot be marked as hidden or system. The exception is [MMEMory:MDIRectory](#), which creates a folder. For MMEMory:MDIRectory, all folder levels above the new one must exist.

Format for a <file>

- The format for a file name is "[[<drive>:]<path>]<file_name>", where <drive> can be INTERNAL or USB, and <path> is a folder path.
- INTERNAL specifies the internal flash file system. USB specifies a front panel USB storage device.
- If <drive> is specified, <path> is interpreted as an absolute folder path. Absolute paths begin with "\" or "/" and start at the root folder of <drive>.
- If <drive> is omitted, <path> is relative to the folder specified by [MMEMory:CDIRectory](#). Relative paths must NOT begin with \ or /.
- Folder and file names cannot contain the following characters: \ / : * ? " < > |
- The combination of folder and file name cannot exceed 240 characters.

MMEMory:DOWNload:DATA <binary_block>

Downloads data from the host computer to a file whose name has been specified by [MMEMory:DOWNload:FNAME](#).

The data in <binary_block> is written to the selected file.

NOTE Any data previously stored in the file is lost when you execute this command.

Parameter	Typical Return
Any IEEE-488.2 definite- or indefinite-length block	(none)
Write "Hello" to the file "\\Myfile" on internal storage.	
MMEM:DOWN:FNAME "INT:\\Myfile"	
MMEM:DOWN:DATA #15Hello	

MMEMory:DOWNload:FNAME <filename>

MMEMory:DOWNload:FNAME?

Creates or opens the specified filename prior to writing data to that file with [MMEMory:DOWNload:DATA](#).

Parameter	Typical Return
Any valid file name	(none)
Write "Hello" to the file "\\Myfile" on internal storage.	
MMEM:DOWN:FNAME "INT:\\Myfile"	
MMEM:DOWN:DATA #15Hello	

- The specified folder must exist and cannot be marked as hidden or system.
- If the destination file exists, it will be overwritten, unless marked as hidden or system.
- The file is created if it does not already exist.

MMEMory:FORMat:READing:CSEParator {COMMa|SEMicolon|TAB}

MMEMory:FORMat:READing:CSEParator?

Specifies the character used to separate the columns in stored data.

Parameter	Typical Return
{COMMa SEMicolon TAB}. Default: COMMa.	TAB, COMM or SEM
Specify tabs as the column separator:	
MMEMory:FORMat:READing:CSEParator TAB	

- Applies only to the 34465A and 34470A.
- Affects the format for the .csv file created by the [MMEMory:STORE:DATA](#) command, or by the data logging/digitizing features in the 34465A/34470A.

MMEMory:FORMat:READIng:INFormation {OFF|ON}
MMEMory:FORMat:READIng:INFormation?

Disables/enables header information and reading numbers in stored data.

Parameter	Typical Return
{OFF ON}. Default OFF.	OFF or ON
Enable the format for the .csv file: MMEM:FORMat:READIng:INFormation ON	

- Applies only to the 34465A and 34470A.
- The format for the .csv file ([MMEMory:STORe:DATA](#)), or by the data logging/digitizing features in the 34465A/34470A, are affected as follows:
 - OFF** = one reading per row, no other header or reading information.
 - ON** = enables a file header and reading numbers. The file header contains the start date and start time of the first reading and, if the sample source is timer (SAMPLE:SOURce:TIMer), the sample interval. Each data row includes a reading number and the reading.
- Affects the .dat (binary) file created by [MMEMory:STORe:DATA](#) as follows:
 - OFF** = one reading per row, no other header or per reading information.
 - ON** = one time stamp row consisting of eight 16-bit integers for: year, month, day of week, day, hour, minute, and milliseconds. 32-bit integer reading number and 64-bit IEEE-754 reading.

MMEMory:FORMat:READIng:RLIMit {OFF|ON}
MMEMory:FORMat:READIng:RLIMit?

When enabled, limits the maximum number rows per stored .csv data file to one million, including any header row, if enabled.

Parameter	Typical Return
{OFF ON}. Default ON.	OFF or ON
Disable row limits for the .csv file: MMEM:FORM:READ:RLIMit OFF	

- Applies only to the 34465A and 34470A.
- Affects the format for the .csv file created by the [MMEMory:STORe:DATA](#) command, or by the data logging/digitizing features in the 34465A/34470A.
- This feature enables you to accommodate common spreadsheet, database and data analysis programs that have limitations of 1 million rows per file.
- ON - Readings are stored in files named dat00001.csv, dat00002.csv, dat00003.csv ...
- OFF - Readings are is stored in a single file named dat00001.csv. The file size is limited to $2^{32} = 4.294967296$ GBytes (the maximum allowed by the FAT32 file system).

MMEMory:STORe:DATA RDG_STORE, <file>

Stores all measurements in reading memory to the specified data file. The file name optionally includes the folder name and the .csv or .dat file extension.

Parameter	Typical Return
Any valid file name	(none)
Store all measurements in reading memory to MyVoltMeas.csv in the root folder of the internal flash file system.	
MMEM:STOR:DATA RDG_STORE,"INT:\MyVoltMeas"	

- If a .csv file extension is specified, or if no file extension is specified, the data is stored in ASCII format. If the .dat file extension is specified, the data is stored in binary format.
- The format of the file is affected by [MMEMory:FORMat:READing:CSEParator](#), [MMEMory:FORMat:READing:INFormation](#), and [MMEMory:FORMat:READing:RLIMit](#).
- The destination folder must exist and cannot be marked as hidden or system.
- If the destination file exists, it will be overwritten, unless marked as hidden or system.

MMEMory:UPLoad? <filename>

Uploads the contents of a file from the instrument to the host computer.

Parameter	Typical Return
Any valid file name	IEEE 488.2 definite-length block
Upload the state file "Myfile.sta" in the root directory of the internal flash file system to the host computer:	
MMEM:UPL? "INT:\Myfile.sta"	

SAMPle Subsystem

The SAMPle commands are used with the TRIGger commands to set up the triggering parameters. Use the SAMPle commands to set a sample count, sample source, and delay time for triggered sampling.

NOTE

It is recommended that all triggered measurements be made using an appropriate fixed manual range. That is, turn autorange off ([SENSe:<function>:RANGe:AUTO OFF](#)), or set a fixed range using the [SENSe:<function>:RANGe](#), [CONFigure](#), or [MEASure](#) command.

Command Summary

[SAMPle:COUNT](#)

[SAMPle:COUNT:PRETrigger](#)

[SAMPle:SOURce](#)

[SAMPle:TIMer](#)

SAMPle:COUNT {<count>|MIN|MAX|DEF}

SAMPle:COUNT? [{MIN|MAX|DEF}]

Specifies the number of measurements (samples) the instrument takes per trigger.

Parameter	Typical Return
1 to 1,000,000 (1x10 ⁶). Default: 1. (34460A/61A) 1 to 1,000,000,000 (1x10 ⁹). Default: 1. (34465A/70A)	+1
Return ten sets of four resistance measurements, using an external trigger to start each measurement set: CONF:RES 1E6 SAMP:COUN 4 TRIG:COUN 10 TRIG:SOUR EXT;SLOP NEG READ? Typical Response: +1.00520000E+06, ... (40 measurements)	

- The front panel sample annunciator ("*") turns on during each measurement at slower rates. The annunciator toggles at a fixed rate for fast measurements.
- You can use the specified sample count in conjunction with a trigger count ([TRIGger:COUNT](#)), which sets the number of triggers to be accepted before returning to the "idle" trigger state. The total number of measurements returned are the product of the sample count and trigger count.
- You can store up to 1,000 measurements in the reading memory of the 34460A, 10,000 measurements on the 34461A, 50,000 measurements on the 34465A/70A (*without* the MEM option), or 2,000,000 measurements on the 34465A/70A (*with* the MEM option). If reading memory overflows, new measurements overwrite the oldest measurements stored; the most recent measurements are always preserved. No error is generated, but the Reading Mem Ovfl bit (bit 14) is set in the Questionable Data Register's condition register (see [Status System Introduction](#)).

- MAX selects 1 billion readings. However, when pretrigger is selected, the maximum is 50,000 readings (*without* the MEM option) or 2,000,000 readings (*with* the MEM option).
- This parameter is set to its default value after a Factory Reset (***RST**) or Instrument Preset (**SYSTem:PRESet**).

SAMPlE:COUNT:PRETrigger {<count>|MIN|MAX|DEF}

SAMPlE:COUNT:PRETrigger? [{MIN|MAX|DEF}]

Allows collection of the data being digitized *before* the trigger. Reserves memory for pretrigger samples up to the specified number of pretrigger samples.

NOTE

It is recommended that all triggered measurements be made using an appropriate fixed manual range. That is, turn autorange off (**SENSe:<function>:RANGe:AUTO OFF**), or set a fixed range using the **SENSe:<function>:RANGe**, **CONFigure**, or **MEASure** command.

Parameter	Typical Return
0 to 1,999,999. Default: 0.	+999999
Configure AC voltage measurements using the 100 V range. Set the sample count to 10,000 and the pretrigger sample count to 5000 (5000 samples are taken before the trigger, and 5000 after). The trigger occurs when the input signal reaches 0.75 volts. CONF:VOLT:AC VOLT:AC:RANG 100 SAMP:COUN 10000 SAMP:COUN:PRET 5000 TRIG:SOUR INT TRIG:LEV 0.75 INIT	

- Applies only to the 34465A and 34470A.
- Pretrigger applies to all measurement functions except CONTinuity and DIODe test.
- Use **SAMPlE:COUNT** to set the *total* number of samples to take, then use **SAMPlE:COUNT:PRETrigger** to set the number of pretrigger samples to take.

For example, with a sample count of 50,000, and a pretrigger sample count of 20,000, up to 20,000 samples are taken before the trigger, then 30,000 samples are taken after the trigger occurs.

The sample count and pretrigger count do not affect when the trigger occurs. If the memory allocated for pretrigger samples fills up, the oldest readings are discarded. In the example above, the 20,000 *most recent* pretrigger samples are saved, even if more than 20,000 samples occur before the trigger. If the trigger occurs *before* the pretrigger count is satisfied, only the actual pretrigger samples taken are saved.

In all cases, after the trigger is received, only *sample count* minus *specified pretrigger count* readings are taken. In this example, if the trigger occurs after 5 pretrigger samples have been taken (instead of the specified 20,000), only 30,000 post-trigger samples are taken. This is because memory was reserved for 20,000 pretrigger samples.

- If a trigger occurs during a measurement, that measurement is considered to be a pretrigger sample.

- After setting the sample count and pretrigger sample count, you must place the DMM in the "wait-for-trigger" state using [INITiate](#) or [READ?](#) An external trigger is buffered until the DMM is in the "wait-for-trigger" state.
- The pretrigger sample count must be less than the sample count set with the [SAMPle:COUNT](#) command, and there must be at least one post-trigger sample:

$$\text{Pretrigger Sample Count} \leq \text{Sample Count} - 1$$

- If any of the calculation functions are on ([CALC:STAT ON](#)), the pretrigger count is limited to 10,000 samples.
- [CONFigure](#) and [MEASure?](#) set the pretrigger sample count to "0".
- The instrument sets the pretrigger sample count to "0" after a Factory Reset (*RST command) or a Pre-set (SYSTem:PRESet command).

See Also

[SAMPle:COUNT](#)

SAMPle:SOURce {IMMEDIATE|TIMER}
SAMPle:SOURce?

Determines sample timing, with [TRIGger:DElay](#) and [SAMPle:TIMer](#) to determine sample timing, when the sample count is greater than one.

NOTE

It is recommended that all triggered measurements be made using an appropriate fixed manual range. That is, turn autorange off ([SENSe:<function>:RANGe:AUTO OFF](#)), or set a fixed range using the [SENSe:<function>:RANGe](#), [CONFigure](#), or [MEASure](#) command.

Parameter	Typical Return
{IMMEDIATE TIMER}. Default: IMMEDIATE.	IMM or TIM
Set sample source to timer. The INIT command sets the meter to the "wait-for-trigger" state. When a trigger is received from the selected trigger source, the instrument starts taking periodic samples after the trigger delay.	
SAMP:SOUR TIM SAMP:TIM 0.1 INIT	

Operation

In all cases, the first sample is taken one trigger delay time after the trigger (the delay being set with the [TRIGger:DElay](#) command). Beyond that, the timing mechanism depends on whether you select IMMEDIATE (default) or TIMER as the source:

- IMMEDIATE - The first sample starts one trigger delay time after the trigger, and then the trigger delay time is inserted between the first and second samples, the second and third, and so on:

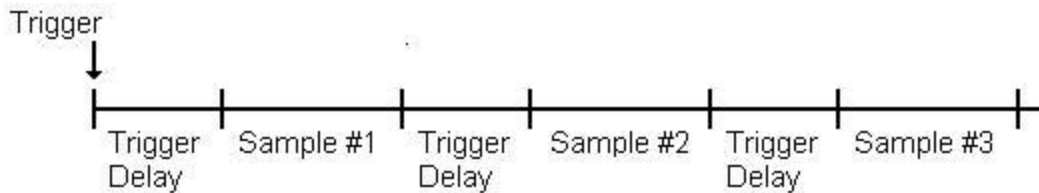

The sample timing *is not* deterministic because the delay time (set with [TRIGger:DElay](#)) is inserted *after* each sample completes. The actual time required to take each sample depends on the integration time and autoranging time. In this case, the [SAMple:TIMer](#) command has no effect.

- **Timer** - The first sample starts one trigger delay time after the trigger. However, the second sample starts one sample interval after the start of the first sample, and so on:

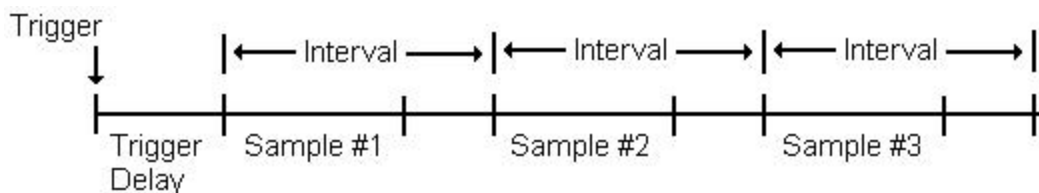

The sample timing *is* deterministic because the start of each sample is determined by the sample interval, set with the [SAMple:TIMer](#) command ([TRIGger:DElay](#) affects only the start of the first sample). Integration and autoranging affect the sampling time for each sample, but not the sample interval as long as the sample interval is longer than the sampling time.

Remarks

- Applies only to the 34465A and 34470A.
- This command has no effect if the sample count is 1 (see [SAMple:COUNT](#)).
- After setting the sample count, sample source, and the sample interval or trigger delay time, you must place the instrument in the "wait-for-trigger" state using the [INITiate](#) or [READ?](#) command. A trigger is not accepted from the selected trigger source (see [TRIGger:SOURce](#) command) until the instrument is in the "wait-for-trigger" state.
- The instrument sets the sample source to "IMM" after a Factory Reset ([*RST](#) command) or an instrument Preset ([SYSTem:PRESet](#) command).

See Also

[TRIGger:COUNT](#)

[TRIGger:DElay](#)

[TRIGger:SOURce](#)

[SAMple:COUNT](#)

[SAMple:TIMer](#)

SAMPle:TIMer {<interval>|MIN|MAX|DEF}

SAMPle:TIMer? [{MIN|MAX|DEF}]

Sets a sample interval for timed sampling ([SAMPle:SOURce TIMer](#)) when the sample count is greater than one.

The first sample is taken one trigger delay time after the trigger (delay set by [TRIGger:DELay](#)). The second sample starts one sample interval after the start of the first sample, and so forth, as shown below:

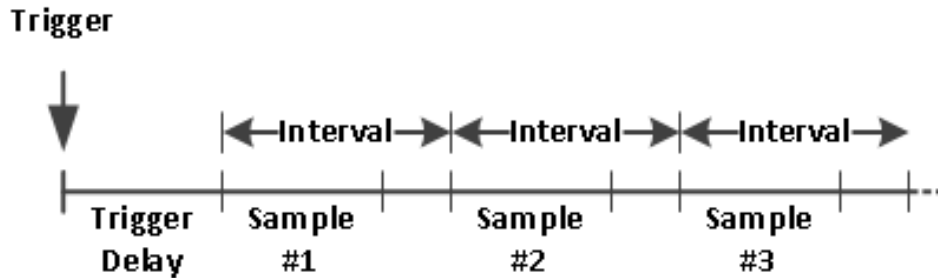

Note that the sample timing is determinant because the start of each sample is determined by the sample interval. Integration and autoranging affect the sampling time for each sample, but not the sample interval as long as the sample interval is longer than the sampling time. Periodic sampling continues until the sample count (set with the [SAMPle:COUNt](#) command) is satisfied.

NOTE

It is recommended that all triggered measurements be made using an appropriate fixed manual range. That is, turn autorange off ([SENSe:<function>:RANGe:AUTO OFF](#)), or set a fixed range using the [SENSe:<function>:RANGe](#), [CONFigure](#), or [MEASure](#) command. When autorange is left on, the starting time of a sample becomes uncertain (when a range change occurs) and when ranging exceeds the interval between samples; then all subsequent samples become offset from their desired start points.

Parameter	Typical Return
<interval> MIN (see bullet points below) to 3600 seconds (~1 μs steps).	+3.60000000E+003
Set the sample interval to 0.1 seconds. INIT sets the meter to the "wait-for-trigger" state. When a trigger is received from the selected trigger source, the instrument waits the trigger delay time, and then takes readings every 0.10 seconds until the sample count is satisfied.	
SAMP:SOUR TIM SAMP:TIM 0.1 INIT	

- The value of MIN is measurement dependent. It depends on such things as the integration time, autozero on or off, autorange on or off, and the measurement range. Basically, MIN is automatically determined so that the sample interval is always greater than the sampling time (see above illustration). Execute `SAMPle:TIMer? MIN` to determine the recommended interval for the current measurement configuration.

- Since the minimum value changes depending on configuration, a command order dependency exists. You must completely configure the measurement before setting the sample timer to MIN, or you may generate an error. A complete configuration includes such things as math statistics or scaling.
- When using autorange, the MIN value is the *recommended* value, not the *absolute minimum* value. With autorange enabled, MIN is calculated assuming a single range change will occur for every measurement (not multiple ranges, just one range up or down per measurement). You can specify an *<interval>* between the absolute minimum (assumes no range changes) and the recommended MIN value, but it may generate a timing violation error when making measurements. Applying a value less than the absolute minimum will generate an error.
- To determine the absolute minimum value for the present configuration, set the sample time to 20 μs (which may generate a settings conflict error), then read back the current sample timer value using the `SAMPle:TIMer?` query. The sample source must be set to timer with a sample count or trigger count greater than 1, for the settings conflict error to occur. The settings conflict error causes the timer to be set to the absolute minimum value.
- The sample time resolution is 1 μs , the aperture resolution is 2 μs , and the actual hardware resolution is not exactly 1 μs . There are cases where a sample time value, rounded to the nearest hardware resolution, will result in a smaller value than aperture when rounded to 2 μs . This will create error -221, "*Settings conflict; cannot meet requested timing; SAMP:TIM changed*". For example, the following sequence of commands generates error -221 and sets the sample time to +2.00100000E-003.

```
*RST
FUNC "VOLT:DC"
VOLT:DC:APER 0.002
VOLT:DC:RANGE:AUTO OFF
VOLT:DC:ZERO:AUTO OFF
TRIG:DEL 0
TRIG:SOUR BUS
SAMP:COUN 2
SAMP:TIM 0.002
SAMP:SOUR TIM
```

This error can also occur if you attempt to set both values an odd number of μs . For example, setting both values to 23 μs , generates error -221 and sets the sample timer to 24 μs .

- After setting the sample count, source, and delay time, you must place the meter in the "wait-for-trigger" state using the [INITiate](#) or [READ?](#) command. A trigger is not accepted from the selected trigger source (see [TRIGger:SOURce](#) command) until the instrument is in the "wait-for-trigger" state.
- The interval may be set to any value from the absolute minimum described above to 3600 seconds. However, the value is rounded to the nearest step. For dc measurements, the step size is 1 μs . For ac measurements, it is ac bandwidth dependent.
- The instrument sets the sample timer to 1 second after a reset ([*RST](#) command) or an instrument pre-set ([SYSTem:PRESet](#) command).

See Also

[TRIGger:COUNT](#)

TRIGger:DELay

TRIGger:SOURce

SAMPlE:COUNT

SAMPlE:SOURce

SENSe Subsystem Introduction

The SENSE subsystem configures measurements. The most basic SENSE command is [\[SENSe:\]FUNCTioN\[:ON\]](#), which selects the measurement function. All other SENSE commands are associated with specific measurement types:

[Capacitance](#) (34465A and 34470A only)

[Current](#)

[Data2](#)

[Frequency and Period](#)

[2-Wire and 4-Wire Resistance](#)

[Temperature](#)

[Voltage](#)

[SENSe:]FUNCTioN[:ON] "<function>"
[SENSe:]FUNCTioN[:ON]?

Selects the measurement function (all function-related measurement attributes are retained).

Parameter	Typical Return
CAPacitance CONTInuity CURRent:AC CURRent[:DC] DIODe FREQuency FRESistance PERiod RESistance TEMPerature VOLTage:AC VOLTage[:DC] VOLTage[:DC]:RATio The default is VOLTage[:DC].	The short form of the selected function is returned in quotation marks, with no optional keywords: "CONT", "CURR:AC", "CURR", "DIOD", and so on.
Select the AC voltage function: FUNC "VOLT:AC"	

- If you change the measurement function, all measurement attributes of the previous function (range, resolution, etc.) are remembered. If you return to the original function, those measurement attributes are restored.
- Changing the measurement function disables scaling, limit testing, histogram, statistics, and trend chart data collection ([CALC:SCAL:STAT](#), [CALC:LIM:STAT](#), [CALC:TRAN:HIST:STAT](#), [CALC:AVER:STAT](#), and [CALC:TCH:STAT](#) set to OFF).
- This parameter is set to its default value after a Factory Reset ([*RST](#)) or Instrument Preset ([SYSTEM:PRESet](#)).

[SENSe:]CAPacitance Subsystem

This subsystem configures capacitance measurements.

Command Summary

[\[SENSe:\]CAPacitance:NULL\[:STATe\]](#)

[\[SENSe:\]CAPacitance:NULL:VALue](#)

[\[SENSe:\]CAPacitance:NULL:VALue:AUTO](#)

[\[SENSe:\]CAPacitance:RANGe:AUTO](#)

[\[SENSe:\]CAPacitance:RANGe](#)

[\[SENSe:\]CAPacitance:SECondary](#)

[SENSe:]CAPacitance:NULL[:STATe] {ON|1|OFF|0}

[SENSe:]CAPacitance:NULL[:STATe]?

Turns the null function on or off for capacitance measurements.

Parameter	Typical Return
{ON 1 OFF 0}. Default: ON.	0 (OFF) or 1 (ON)
Configure capacitance measurements, turn null function on, use the AUTO null function. Make two measurements and send them to the instrument's output buffer: CONF:CAP AUTO CAP:NULL ON CAP:NULL:VAL:AUTO ON SAMP:COUN 2 READ? Typical Response: +3.01963841E-10,+3.01566277E-10	

- Enabling the scaling function also enables automatic null value selection ([\[SENSe:\]CAPacitance:NULL:VALue:AUTO](#)).
- To set a fixed null value, use: [\[SENSe:\]CAPacitance:NULL:VALue](#).
- The instrument disables the null function after a Factory Reset (***RST**), Instrument Preset (**SYSTem:PRESet**), or CONFigure function.

[SENSe:]CAPacitance:NULL:VALue {<value>|MIN|MAX|DEF}

[SENSe:]CAPacitance:NULL:VALue? [{MIN|MAX|DEF}]

Stores a null value for capacitance measurements. The null value is subtracted from each sample if the null state is turned on.

Parameter	Typical Return
<value> -120 to +120 μ F. Default: 0.	-1.20000000E-04
Configure capacitance measurements, turn null function on. Make two measurements and send them to the instrument's output buffer: CONF:CAP AUTO CAP:NULL ON CAP:NULL:VAL 1.2E-12 SAMP:COUN 2 READ? Typical Response: +3.01963841E-10,+3.01566277E-10	

- Specifying a null value disables automatic null value selection ([SENSe:]CAPacitance:NULL:VALue:AUTO OFF).
- To use the null value, turn on the null state with the [Sense:]CAPacitance:NULL[:STATe] command.
- This parameter is set to its default value after a Factory Reset (*RST), Instrument Preset (SYSTem:PRESet), or CONFigure function.

[SENSe:]CAPacitance:NULL:VALue:AUTO {ON|1|OFF|0}
 [SENSe:]CAPacitance:NULL:VALue:AUTO?

Enables or disables automatic null value selection for capacitance measurements.

Parameter	Typical Return
{ON 1 OFF 0}. Default: ON.	0 (OFF) or 1 (ON)
Configure capacitance measurements, turn null function on, use the AUTO null function. Make two measurements and send them to the instrument's output buffer: CONF:CAP AUTO CAP:NULL ON CAP:NULL:VAL:AUTO ON SAMP:COUN 2 READ? Typical Response: +3.01963841E-10,+3.01566277E-10	

- When automatic reference selection is ON, the first measurement made is used as the null value for all subsequent measurements. [SENSe:]CAPacitance:NULL:VALue is set to this value. Automatic null value selection will be disabled.
- When automatic null value selection is disabled (OFF), the null value is specified by: [SENSe:]CAPacitance:NULL:VALue.
- The instrument enables automatic null value selection when the null function is enabled ([SENSe:]CAPacitance:NULL:STATe ON).
- This parameter is set to its default value after a Factory Reset (*RST), Instrument Preset (SYSTem:PRESet), or CONFigure function.

[SENSe:]CAPacitance:RANGe:AUTO {OFF|ON|ONCE}
 [SENSe:]CAPacitance:RANGe:AUTO?

Disables or enables autoranging for capacitance measurements.

Parameter	Typical Return
{OFF ON ONCE}. Default: ON.	0 (OFF) or 1 (ON)
Configure capacitance measurements, turn autorange on, turn null function on, use the AUTO null function. Make two measurements and send them to the instrument's output buffer: CONF:CAP CAP:RANG:AUTO ON CAP:NULL ON CAP:NULL:VAL:AUTO ON SAMP:COUN 2 READ? Typical Response: +3.01963841E-10,+3.01566277E-10	

- Autoranging goes down a range at less than 10% of range and up a range at greater than 120% of range. For capacitance measurements only, when autorange is off, the instrument does not report an overload for readings greater than 120% of range. Overload only occurs when the algorithm times out

because the applied capacitance is too large for the algorithm to measure. If you apply a DC voltage or a short to the input terminals in capacitance measurement mode, the instrument reports an overload.

- ONCE performs an immediate autorange, and then sets autoranging to OFF. (Thus, the query returns "0".)
- Selecting a discrete range (see [\[Sense:\]CAPacitance:RANGe](#) command) disables autoranging.
- This parameter is set to its default value after a Factory Reset ([*RST](#)) or Instrument Preset ([SYSTem:PRESet](#)).

[SENSe:]CAPacitance:RANGe {<range>|MIN|MAX|DEF}

[SENSe:]CAPacitance:RANGe? [{MIN|MAX|DEF}]

Selects a fixed range for capacitance measurements.

Parameter	Typical Return
<range>: {1 nF 10 nF 100 nF 1 μF 10 μF 100 μF}. Default: AUTO.	+1.00000000E-09
Configure capacitance measurements, select 1 nF range, turn null function on, use the AUTO null function. Make two measurements and send them to the instrument's output buffer: CONF:CAP CAP:RANG 1 nF or CAP:RANG 1.0E-9 CAP:NULL ON CAP:NULL:VAL:AUTO ON SAMP:COUN 2 READ? Typical Response: +3.01963841E-10,+3.01566277E-10	

- Selecting a fixed range ([SENSe:]<function>:RANGe) disables autoranging.
- If the input signal is greater than can be measured on the specified fixed range, the instrument displays *Overload* on front panel and returns "9.9E37" from the remote interface.
- This parameter is set to its default value after a Factory Reset ([*RST](#)) or Instrument Preset ([SYSTem:PRESet](#)).

[SENSe:]CAPacitance:SEConDary {"OFF"|"CALCulate:DATA"}
 [SENSe:]CAPacitance:SEConDary?

Selects the secondary measurement function for capacitance measurements.

Parameter	Typical Return
{"OFF" "CALCulate:DATA"}, default "OFF"	"CALC:DATA"
Configure capacitance and secondary measurements. Make capacitance measurement and retrieve secondary measurement. CONF:CAP AUTO,MAX CAP:SEC "CALC:DATA" READ?;DATA2? Typical Response: +3.01566373E-10;+3.01566373E-10	

- "CALCulate:DATA" - The measurement value before any math operations are done (including NULL).
- Use [READ?](#) or [INITiate](#) to start the measurement. Use [\[SENSe:\]DATA2?](#) to retrieve the secondary measurement.
- This parameter is set to its default value after a Factory Reset ([*RST](#)) or Instrument Preset ([SYSTem:PRESet](#)).

[SENSe:]CURRent Subsystem

This subsystem configures AC and DC current measurements.

Command Summary

[SENSe:]CURRent:AC:BANDwidth

[SENSe:]CURRent:{AC|DC}:NULL[:STATe]

[SENSe:]CURRent:{AC|DC}:NULL:VALue

[SENSe:]CURRent:{AC|DC}:NULL:VALue:AUTO

[SENSe:]CURRent:{AC|DC}:RANGe

[SENSe:]CURRent:{AC|DC}:RANGe:AUTO

[SENSe:]CURRent:{AC|DC}:TERMinals

[SENSe:]CURRent:AC:SECondary

[SENSe:]CURRent[:DC]:APERture

[SENSe:]CURRent[:DC]:APERture:ENABled

[SENSe:]CURRent[:DC]:NPLC

[SENSe:]CURRent[:DC]:RESolution

[SENSe:]CURRent[:DC]:SECondary

[SENSe:]CURRent[:DC]:ZERO:AUTO

[SENSe:]CURRent:SWITCh:MODE

[SENSe:]CURRent:AC:BANDwidth {<filter>|MIN|MAX|DEF}
 [SENSe:]CURRent:AC:BANDwidth? [{MIN|MAX|DEF}]

Sets the bandwidth for AC current measurements.

The instrument uses three different AC filters that enable you either to optimize low frequency accuracy or to achieve faster AC settling times following a change in input signal amplitude.

NOTE On the 34461A, 34465A, or 34470A, use the [\[SENSe:\]CURRent:{AC|DC}:TERMinals](#) command to specify which current terminals to use for the measurement.

Parameter	Typical Return
{3 Hz 20 Hz 200 Hz}. Default: 20Hz.	+2.00000000E+01
Make and read an AC current measurement. Use the 3 Hz filter bandwidth: CONF:CURR:AC 1 CURR:AC:BAND 3 READ? Typical Response: +5.23918293E+00	

- If you enter the lowest expected frequency that you intend to encounter, the command will select the appropriate <filter>. For example, if you enter 15 Hz, the slow filter (3 Hz) is selected. If you enter 190 Hz, the medium filter (20 Hz) is selected to provide the appropriate low cutoff.
- Set the lowest frequency that you expect to encounter. Lower bandwidths result in longer settling delays, as shown:

Input Frequency	Default Settling Delay
3 Hz - 300 kHz (<i>Slow</i>)	1.66 s/measurement
20 Hz - 300 kHz (<i>Medium</i>)	0.25 s/measurement
200 Hz - 300 kHz (<i>Fast</i>)	0.025 s/measurement

- This parameter is set to its default value after a Factory Reset ([*RST](#)) or Instrument Preset ([SYSTEM:PRESet](#)).

[SENSe:]CURRent:{AC|DC}:NULL[:STATe] {ON|1|OFF|0}
 [SENSe:]CURRent:{AC|DC}:NULL[:STATe]?

Enables or disables the null function for AC or DC current measurements.

NOTE This parameter setting is not shared between AC and DC measurements. The parameters are independent for AC and DC measurements.

NOTE On the 34461A, 34465A, or 34470A, use the [\[SENSe:\]CURRent:{AC|DC}:TERMinals](#) command to specify which current terminals to use for the measurement.

Parameter	Typical Return
{ON 1 OFF 0}. Default: OFF.	0 (OFF) or 1 (ON)
Configure AC current measurements, using the null function to subtract 100 mA from the measurements. Then make two measurements and send them to the instrument's output buffer: CONF:CURR:AC CURR:AC:NULL:STAT ON;VAL 100 mA SAMP:COUN 2 READ? Typical Response: +1.04530000E+00,+1.04570000E+00	

- Enabling the scaling function also enables automatic null value selection ([\[SENSe:\]CURRent:{AC|DC}:NULL:VALue:AUTO ON](#)).
- To set a fixed null value, use: [\[SENSe:\]CURRent:{AC|DC}:NULL:VALue](#).
- The instrument disables the null function after a Factory Reset ([*RST](#)), Instrument Preset ([SYSTem:PRESet](#)), or CONFigure function.

[SENSe:]CURRent:{AC|DC}:NULL:VALue {<value>|MIN|MAX|DEF}
 [SENSe:]CURRent:{AC|DC}:NULL:VALue? [{MIN|MAX|DEF}]

Sets the null value for AC or DC current measurements.

NOTE This parameter setting is not shared between AC and DC measurements. The parameters are independent for AC and DC measurements.

NOTE On the 34461A, 34465A, or 34470A, use the [\[SENSe:\]CURRent:{AC|DC}:TERMinals](#) command to specify which current terminals to use for the measurement.

Parameter	Typical Return
-12 to 12 A. Default: 0	+1.04530000E+00
Configure AC current measurements, using the null function to subtract 100 mA from the measurements. Then make two measurements and send them to the instrument's output buffer: CONF:CURR:AC CURR:AC:NULL:STAT ON;VAL 100 mA SAMP:COUN 2 READ? Typical Response: +1.04530000E+00,+1.04570000E+00	

- Specifying a null value disables automatic null value selection ([\[SENSe:\]CURRent:{AC|DC}:NULL:VALue:AUTO OFF](#)).
- To use the null value, the null state must be on ([\[SENSe:\]CURRent:{AC|DC}:NULL:STATe ON](#)).
- This parameter is set to its default value after a Factory Reset ([*RST](#)), Instrument Preset ([SYSTem:PRESet](#)), or CONFigure function.

[SENSe:]CURRent:{AC|DC}:NULL:VALue:AUTO {ON|1|OFF|0}
 [SENSe:]CURRent:{AC|DC}:NULL:VALue:AUTO?

Enables or disables automatic null value selection for AC or DC current measurements.

NOTE This parameter setting is not shared between AC and DC measurements. The parameters are independent for AC and DC measurements.

NOTE On the 34461A, 34465A, or 34470A, use the [\[SENSe:\]CURRent:{AC|DC}:TERMinals](#) command to specify which current terminals to use for the measurement.

Parameter	Typical Return
{ON 1 OFF 0}. Default: ON.	0 (OFF) or 1 (ON)
Configure AC current measurements, using the null function to subtract 100 mA from the measurements. Then make two measurements and send them to the instrument's output buffer: CONF:CURR:AC CURR:AC:NULL:STAT ON;VAL 100 mA SAMP:COUN 2 READ? Typical Response: +1.04530000E+00,+1.04570000E+00 Make a second set of measurements using automatic null value selection: CURR:AC:NULL:VAL:AUTO ON READ? Typical Response: +0.00000000E+00,+0.01420000E+00	

- When automatic reference selection is ON, the first measurement made is used as the null value for all subsequent measurements. [\[SENSe:\]CURRent:{AC|DC}:NULL:VALue](#) is set to this value. Automatic null value selection will be disabled.
- When automatic null value selection is disabled (OFF), the null value is specified by: [\[SENSe:\]CURRent:{AC|DC}:NULL:VALue](#).
- The instrument enables automatic null value selection when the null function is enabled ([\[SENSe:\]CURRent:{AC|DC}:NULL:STATe ON](#)).
- This parameter is set to its default value after a Factory Reset ([*RST](#)), Instrument Preset ([SYSTEM:PRESet](#)), or CONFigure function.

[SENSe:]CURRent:{AC|DC}:RANGe {<range>|MIN|MAX|DEF}
 [SENSe:]CURRent:{AC|DC}:RANGe? [{MIN|MAX|DEF}]

Selects a fixed measurement range for AC or DC current measurements on the 3 A terminals. For DMMs with a 10 A range, you cannot select the 10 A range with this command; instead, use [\[SENSe:\]CURRent:{AC|DC}:TERMIinals 10](#) or [CONF:CURRent:{AC|DC} 10](#).

NOTE This parameter setting is not shared between AC and DC measurements. The parameters are independent for AC and DC measurements.

NOTE On the 34461A, 34465A, or 34470A, use the [\[SENSe:\]CURRent:{AC|DC}:TERMIinals](#) command to specify which current terminals to use for the measurement.

Parameter	Typical Return
<range> : {100 µA 1 mA 10 mA 100 mA 1 A 3 A}. Default: AUTO (autorange). The 34465A/70A have additional DC current ranges of 1 µA and 10 µA.	+1.00000000E-01
Configure AC current measurements using the 1 A range. Make and read two measurements: CONF:CURR:AC CURR:AC:RANG 1 SAMP:COUN 2 READ? Typical Response: +1.04530000E+00,+1.04570000E+00	

- Selecting a fixed range ([SENSe:]<function>:RANGe) disables autoranging.
- If the input signal is greater than can be measured on the specified manual range, the instrument displays the word *Overload* on front panel and returns "9.9E37" from the remote interface.
- Unlike CONFigure and MEASure?, this command does not support the 10 A range. Selecting the 10 A terminal with [\[SENSe:\]CURRent:{AC|DC}:TERMIinals](#) forces the specified type of current measurements to use the 10 A range, but it does not affect the values of [\[SENSe:\]CURRent:{AC|DC}:RANGe](#) or [\[SENSe:\]CURRent:{AC|DC}:RANGe:AUTO](#).
- Changing the value of this parameter always changes the measurement resolution. The number of PLCs (NPLC) stays fixed, and this results in a change of resolution in terms of the units of the measurement. For example, if you have a measurement with 1 µA resolution on the 100 mA range, changing to the 1 A range results in a resolution of 10 µA.
- This parameter is set to its default value after a Factory Reset ([*RST](#)) or Instrument Preset ([SYSTem:PRESet](#)).

[SENSe:]CURRent:{AC|DC}:RANGe:AUTO {OFF|ON|ONCE}
[SENSe:]CURRent:{AC|DC}:RANGe:AUTO?

Disables or enables autoranging for AC or DC current measurements. Autoranging is convenient because it automatically selects the range for each measurement based on the input signal.

Specifying ONCE performs an immediate autorange and then turns autoranging off.

NOTE This parameter setting is not shared between AC and DC measurements. The parameters are independent for AC and DC measurements.

NOTE On the 34461A, 34465A, or 34470A, use the [\[SENSe:\]CURRent:{AC|DC}:TERMinals](#) command to specify which current terminals to use for the measurement.

Parameter	Typical Return
{ON 1 OFF 0}. Default: ON.	0 (OFF) or 1 (ON)
Configure AC current measurements and perform an immediate autorange. Make and read two measurements: CONF:CURR:AC CURR:AC:RANG:AUTO ONCE SAMP:COUN 2 READ? Typical Response: +1.04530000E-01,+1.04570000E-01	

- Autoranging goes down a range at less than 10% of range and up a range at greater than 120% of range.
- With autoranging enabled, the instrument selects the range based on the input signal.
- Selecting a fixed range ([SENSe:]<function>:RANGe) disables autoranging.
- Selecting the 10 A terminal with [\[SENSe:\]CURRent:{AC|DC}:TERMinals](#) forces the specified type of current measurements to use the 10 A range, but it does not affect the values of [\[SENSe:\]CURRent:{AC|DC}:RANGe](#) or [\[SENSe:\]CURRent:{AC|DC}:RANGe:AUTO](#).
- This parameter is set to its default value after a Factory Reset ([*RST](#)) or Instrument Preset ([SYSTem:PRESet](#)).

[SENSe:]CURRent:{AC|DC}:TERMinals {3|10}
 [SENSe:]CURRent:{AC|DC}:TERMinals?

Configures the AC or DC current measurement to measure the source on the 3 A or 10 A terminals. Note that the 10 A terminal is not available on the 34460A.

Parameter	Typical Return
{3 10}. Default: 3.	+3 or +10
Configure AC current measurements to use the 10 A terminal. Make and read two measurements: CONF:CURR:AC CURR:AC:TERM 10 SAMP:COUN 2 READ? Typical Response: +7.81929394E+00,7.82013671E+00	

- Selecting the 10 A terminal with [\[SENSe:\]CURRent:{AC|DC}:TERMinals](#) forces the specified type of current measurements to use the 10 A range, but it does not affect the values of [\[SENSe:\]CURRent:{AC|DC}:RANGe](#) or [\[SENSe:\]CURRent:{AC|DC}:RANGe:AUTO](#).
- Changing the value of this parameter always changes the measurement range, which results in a change of measurement resolution. The number of PLCs (NPLC) stays fixed, and this results in a change of resolution in terms of the units of the measurement. For example, if you have a measurement with 1 µA resolution on the 1 A range, changing to the 10 A terminals results in a resolution of 10 µA.
- This parameter is set to its default value after a Factory Reset ([*RST](#)) or Instrument Preset ([SYSTem:PRESet](#)).

[SENSe:]CURRent:AC:SECOndary {"OFF"|"CALCulate:DATA"|"FREQuency"|"CURRent[:DC]"}
 [SENSe:]CURRent:AC:SECOndary?

Selects the secondary measurement function for AC current measurements.

Parameter	Typical Return
{"OFF" "CALCulate:DATA" "FREQuency" "CURRent[:DC]"}, default "OFF"	"CALC:DATA"
Configure AC current measurements using the 1 A range. Select frequency as the secondary measurement. Make and retrieve measurements. CONF:CURR:AC 1 CURR:AC:SEC "FREQ" READ?;DATA2? Typical Response: +0.50000000E+00;+1.00000000E+03	

- "CALCulate:DATA" - (Applies only to the 34465A and 34470A.) The measurement value before any math operations are done (including NULL).
- "FREQuency" - The frequency measurement of the input signal.
- "CURRent[:DC]" – The DC current measurement of the input signal. Applies only when using the instrument from the front panel. Setting is ignored for measurements made from a remote interface. If you require both AC and DC current measurements from remote, program each function separately, see [CONFigure:CURRent:{AC|DC}](#).
- This parameter is set to its default value after a Factory Reset (***RST**) or Instrument Preset (**SYSTem:PRESet**).

[SENSe:]CURRent[:DC]:APERture {<seconds>|MIN|MAX|DEF}
 [SENSe:]CURRent[:DC]:APERture? [{MIN|MAX|DEF}]

Specifies the integration time in seconds (called *aperture time*) for dc current measurements.

NOTE Use this command for precise control of the DMM's integration time. Use NPLC (see [\[SENSe:\]CURRent\[:DC\]:NPLC](#)) for better power-line noise rejection characteristics (NPLC > 1).

Parameter	Typical Return
(Without the DIG option) 200 µs to 1 s (2 µs resolution), default: 100 ms. (With the DIG option) 20 µs to 1 s (2 µs resolution), default: 100 ms.	+1.00000000E-01
Enable aperture time mode, set the aperture time to 300 ms: CURR:APER:ENAB ON CURR:DC:APER 300E-03	

- Applies only to the 34465A and 34470A.
- Both the [SENSe:]<function>:NPLC and [SENSe:]<function>:APERture commands control the instrument's integration time. When using both commands (not recommended), whichever command is sent last will override the other command and set the integration time. Sending the [SENSe:]<function>:APERture command sets the [SENSe:]<function>:APERture:ENABLEd command to 1 (ON); sending [SENSe:]<function>:NPLC sets it to 0 (OFF).
- This parameter is set to its default value after a Factory Reset (***RST**) or Instrument Preset (**SYSTem:PRESet**).

[SENSe:]CURRent[:DC]:APERture:ENABLEd {ON|1|OFF|0}
 [SENSe:]CURRent[:DC]:APERture:ENABLEd?

Enables the setting of integration time in seconds (called *aperture time*) for dc current measurements. If aperture time mode is disabled (default), the integration time is set in PLC (power-line cycles).

Parameter	Typical Return
{ON 1 OFF 0}. Default: OFF.	0 (OFF) or 1 (ON)
Enable aperture time mode, set the aperture time to 300 ms: CURR:APER:ENAB ON CURR:DC:APER 300E-03	

- Applies only to the 34465A and 34470A.
- The **CONFigure:CURRent[:DC]**, **MEASure:CURRent[:DC]?**, **[SENSe:]CURRent[:DC]:NPLC**, and **[SENSe:]CURRent[:DC]:RESolution** commands disable the aperture time mode, and select an integration time in number of power line cycles.
- This parameter is set to its default value after a Factory Reset (***RST**) or Instrument Preset (**SYSTem:PRESet**).

[SENSe:]CURRent[:DC]:NPLC {<PLC>|MIN|MAX|DEF}
[SENSe:]CURRent[:DC]:NPLC? [{MIN|MAX|DEF}]

Sets the integration time in number of power line cycles (PLC) for DC current measurements. Integration time is the period that the instrument's analog-to-digital (A/D) converter samples the input signal for a measurement. A longer integration time gives better measurement resolution but slower measurement speed.

NOTE On the 34461A, 34465A, or 34470A, use the [\[SENSe:\]CURRent:{AC|DC}:TERMinals](#) command to specify which current terminals to use for the measurement.

Parameter	Typical Return
0.02, 0.2, 1, 10, 100. Default: 10 (34460A/61A) 0.02, 0.06, 0.2, 1, 10, 100. Default: 10 (34465A/70A without DIG option) 0.001, 0.002, 0.006, 0.02, 0.06, .2, 1, 10, 100. Default: 10 (34465A/70A with DIG option) See Range, Resolution and NPLC for more information.	+1.00000000E+00
Configure DC current measurements using a 10 PLC integration time. Then make and read one measurement: CONF:CURR:DC CURR:DC:NPLC 10 READ? Typical Response: +6.27530000E-01	

- Selecting an integration time in power line cycles overrides an aperture set with the [\[SENSe:\]CURRent\[:DC\]:APERture](#) command.
- Only integration times of 1, 10, or 100 PLC provide normal mode (line frequency noise) rejection.
- Setting the integration time also sets the measurement resolution. [Resolution Table](#) shows the relationship between integration time and resolution.
- This parameter is set to its default value after a Factory Reset ([*RST](#)) or Instrument Preset ([SYSTem:PRESet](#)).

See Also

[\[SENSe:\]CURRent\[:DC\]:RESolution](#)

[SENSe:]CURRent[:DC]:RESolution {<resolution>|MIN|MAX|DEF}
 [SENSe:]CURRent[:DC]:RESolution? [{MIN|MAX|DEF}]

Selects the measurement resolution for DC current measurements. Specify the resolution in the same units as the selected measurement function, not in number of digits.

NOTE On the 34461A, 34465A, or 34470A, use the [\[SENSe:\]CURRent:{AC|DC}:TERMinals](#) command to specify which current terminals to use for the measurement.

Parameter	Typical Return
Specify <resolution> in the measurement's units (V, A, Hz, Ω, and so on).	+3.00000000E-05
Configure DC current measurements with a 3 μA resolution. Then make and read one measurement: CONF:CURR:DC 1 CURR:DC:RES 3E-6 READ? Typical Response: +6.27531500E-01	

- You can specify MIN (best resolution) or MAX (worst resolution) instead of <resolution>.
- To achieve normal mode (line frequency noise) rejection, use a resolution that corresponds to an integration time that is an integral number of power line cycles.
- This parameter is set to its default value after a Factory Reset ([*RST](#)) or Instrument Preset ([SYSTem:PRESet](#)).

See Also

[\[SENSe:\]CURRent\[:DC\]:NPLC](#)

[SENSe:]CURRent[:DC]:SEConDary {"OFF"|"CALCulate:DATA"|"CURRent:AC"|"PTPeak"}
 [SENSe:]CURRent[:DC]:SEConDary?

Selects the secondary measurement function for DC current measurements.

Parameter	Typical Return
{"OFF" "CALCulate:DATA" "CURRent:AC" "PTPeak"}, default "OFF"	"CALC:DATA"
Configure DC current measurements using the 1 A range with 1 mA resolution. Select peak-to-peak as the secondary measurement. Make and retrieve measurements. CONF:CURR:DC 1,0.001 CURR:DC:SEC "PTP" READ?;DATA2? Typical Response: +5.54141768E-06;+9.91000000E+3,+9.91000000E+3	

- "CALCulate:DATA" - (Applies only to the 34465A and 34470A.) The measurement value before any math operations are done (including NULL).
- "CURRent:AC" - The AC current measurement of the input signal. Applies only when using the instrument from the front panel. Setting is ignored for measurements made from a remote interface. If you require both AC and DC current measurements from remote, program each function separately, see [CONFigure:CURRent:{AC|DC}](#).
- "PTPeak" - The peak-to-peak, maximum, and minimum values of the input signal.
- This parameter is set to its default value after a Factory Reset ([*RST](#)) or Instrument Preset ([SYSTem:PRESet](#)).

[SENSe:]CURRent[:DC]:ZERO:AUTO {OFF|ON|ONCE}
 [SENSe:]CURRent[:DC]:ZERO:AUTO?

Disables or enables the autozero mode for DC current measurements.

NOTE On the 34461A, 34465A, or 34470A, use the [\[SENSe:\]CURRent:{AC|DC}:TERMinals](#) command to specify which current terminals to use for the measurement.

Parameter	Typical Return
{OFF ON ONCE}. Default: ON.	0 (OFF) or 1 (ON)
Configure DC current measurements and perform an immediate autozero. Make and read two measurements: CONF:CURR:DC 1 CURR:DC:ZERO:AUTO ONCE SAMP:COUN 2 READ? Typical Response: +1.04530000E-01,+1.04570000E-01	

- **ON (default):** the DMM internally measures the offset following each measurement. It then subtracts that measurement from the preceding reading. This prevents offset voltages present on the DMM’s input circuitry from affecting measurement accuracy.
- **OFF:** the instrument uses the last measured zero measurement and subtracts it from each measurement. It takes a new zero measurement each time you change the function, range or integration time.
- **ONCE:** the instrument takes one zero measurement and sets autozero OFF. The zero measurement taken is used for all subsequent measurements until the next change to the function, range or integration time. If the specified integration time is less than 1 PLC, the zero measurement is taken at 1 PLC to optimize noise rejection. Subsequent measurements are taken at the specified fast (< 1 PLC) integration time.
- The autozero mode is set indirectly when you set the resolution and integration time with [CONFig-ure:CURRent:DC](#) or [MEASure:CURRent:DC?](#). Autozero is automatically turned OFF when you select an integration time less than 1 PLC with these commands.
- This parameter is set to its default value after a Factory Reset ([*RST](#)) or Instrument Preset ([SYSTem:PRESet](#)).

[SENSe:]CURRent:SWITch:MODE {FAST|CONTInuous}
 [SENSe:]CURRent:SWITch:MODE?

Selects the FAST or CONTInuous range change mode for AC and DC current measurements.

Parameter	Typical Return
{FAST CONTInuous}. Default: CONT	CONT
Configure DC current measurements on the 1 mA range. Specify CONTInuous mode. Make and read two measurements: CONF:CURR:DC .001 CURR:SWIT:MODE CONT SAMP:COUN 2 READ?	
Change the current range to 1 V (no open circuit occurs when changing range). Make and read two measurements: CONF:CURR:DC 1 SAMP:COUN 2 READ?	
Typical Response: -5.28836573E-02,-5.01252821E-02	

- Applies only to the 34465A and 34470A.
- The DMM measures AC or DC current by measuring the voltage drop across one of several internal current shunts and then calculating the current. A different shunt is used depending on the selected current range. In CONTInuous mode (default), when changing current ranges, the DMM switches a low impedance in parallel with the first shunt before switching to the next shunt. This eliminates the momentary open circuit when changing ranges, but can take up to three times longer to change ranges than the FAST mode. In FAST mode, when a range change causes the DMM to switch from one shunt to another, a momentary open circuit occurs on the current input terminals. In most cases, this open circuit does not adversely affect your current measurements. However, if an open circuit adversely affects your circuitry or measurements, you can use CONTInuous mode.
- The switch mode applies to the 3A current terminals only. The 10A terminals are always effectively in FAST mode.
- This parameter is set to its default value after a Factory Reset (***RST**) or Instrument Preset (**SYSTem:PRESet**).

[SENSe:]DATA2 Subsystem

This subsystem retrieves or clears secondary measurements.

[SENSe:]DATA2?

Retrieves the secondary measurement.

Parameter	Typical Return
(none)	See example below
Configure DC voltage measurements using the 10 V range with 1 mV resolution. Select peak-to-peak as the secondary measurement. Make and retrieve measurements. CONF:VOLT:DC 10,0.001 VOLT:DC:SEC "PTP" READ?;DATA2? Typical Response: -1.84694879E-03;-2.23115575E-03,+5.98403324E-04,+2.82955909E-03 (<i>Data returned in this order: DCV reading, Min Peak, Max Peak, Peak-to-Peak</i>)	

- Returns 1, 2, or 3 values depending on the active secondary measurement. For example, ratio returns 2 values (main and sense terminal measurements); PTPeak returns 3 values (minimum peak, maximum peak, peak-to-peak).
- If there is currently no valid secondary measurement specified, the query returns "9.91000000E+37" (which is the IEEE488.2 definition of *Not a Number* - usually referred to as *NaN*).
- Configure secondary measurements using [\[SENSe:\]CAPacitance:SECondary](#), [\[SENSe:\]CURRent:AC:SECondary](#), [\[SENSe:\]CURRent:DC:SECondary](#), [\[SENSe:\]FREQuency:SECondary](#), [\[SENSe:\]PERiod:SECondary](#), [\[SENSe:\]TEMPerature:SECondary](#), [\[SENSe:\]VOLTage:AC:SECondary](#), [\[SENSe:\]VOLTage:DC:SECondary](#), or [\[SENSe:\]VOLTage\[:DC\]:RATio:SECondary](#).
- Use [READ?](#) or [INITiate](#) to start the measurement. Use [DATA2?](#) to retrieve the secondary measurement.
- The instrument clears all measurements from reading memory when the measurement configuration changes, or when any of these commands are executed: [INITiate](#), [MEASure:<function>?](#), [READ?](#), [*RST](#), [SYSTem:PRESet](#).

[SENSe:]DATA2:CLEar[:IMMediate]

Clears the latest result(s) of the secondary measurement. This is typically used to clear the accumulated history of the peak-to-peak function ([\[SENSe:\]VOLT:\[DC:\]SEConDary "PTPeak"](#) or [\[SENSe:\]CURRent:\[DC:\]SEConDary "PTPeak"](#)).

Parameter	Typical Return
(none)	See example below
<p>Configure DC voltage measurements using the 10 V range with 1 mV resolution. Select peak-to-peak as the secondary measurement. Make and retrieve measurements.</p> <pre>CONF:VOLT:DC 10,0.001 VOLT:DC:SEC "PTP" READ?;DATA2?</pre> <p>Typical Response: -1.84694879E-03;-2.23115575E-03,+5.98403324E-04,+2.82955909E-03 (<i>Data returned in this order: DCV reading, Min Peak, Max Peak, Peak-to-Peak</i>)</p> <p>Later, clear peak-to-peak secondary measurement data. Make and retrieve measurements.</p> <pre>DATA2:CLE READ?;DATA2?</pre> <p>Typical Response: +1.29177114E-03;+6.07221096E-04,+3.43677658E-03,+2.82955548E-03 (<i>Data returned in this order: DCV reading, Min Peak, Max Peak, Peak-to-Peak</i>)</p>	

[SENSe:]{FREQuency|PERiod} Subsystem

This subsystem configures frequency and period measurements.

Command Summary

[SENSe:]{FREQuency|PERiod}:APERture

[SENSe:]{FREQuency|PERiod}:NULL[:STATe]

[SENSe:]{FREQuency|PERiod}:NULL:VALue

[SENSe:]{FREQuency|PERiod}:NULL:VALue:AUTO

[SENSe:]{FREQuency|PERiod}:RANGe:LOWer

[SENSe:]{FREQuency|PERiod}:TIMeout:AUTO

[SENSe:]{FREQuency|PERiod}:VOLTage:RANGe

[SENSe:]{FREQuency|PERiod}:VOLTage:RANGe:AUTO

[SENSe:]FREQuency:SECondary

[SENSe:]PERiod:SECondary

[SENSe:]{FREQuency|PERiod}:APERture {<seconds>|MIN|MAX|DEF}
 [SENSe:]{FREQuency|PERiod}:APERture? [{MIN|MAX|DEF}]

Sets the aperture time (gate time) for frequency and period measurements.

NOTE This parameter is shared between frequency and period measurements. Setting or querying the parameter with the FREQuency version of this command is identical to setting or querying it with the PERiod version.

Parameter	Typical Return
{1 mS 10 ms 100 ms 1 s}. Default: 100 ms.	+1.00000000E-01
Configure frequency measurements using a 1 s aperture, make a measurement, and return the result: CONF:FREQ FREQ:APER 1 READ?	

- The 1 mS aperture applies only to the 34465A and 34470A.
- The aperture for frequency and period measurements does not autorange.
- The measurement resolution is related to the aperture (gate time) as follows:

Resolution (34460A/61A)	Resolution (34465A/70A)	Aperture
Not Applicable	100 ppm × <range> (MAXimum)	1 ms
100 ppm × <range> (MAXimum)	10 ppm × <range> (DEFault)	10 ms
10 ppm × <range> (DEFault)	1 ppm × <range>	100 ms
1 ppm × <range> (MINimum)	0.1 ppm × <range> (MINimum)	1 s

- This parameter is set to its default value after a Factory Reset (***RST**) or Instrument Preset (**SYSTem:PRESet**).

[SENSe:]{FREQuency|PERiod}:NULL[:STATe] {ON|1|OFF|0}
 [SENSe:]{FREQuency|PERiod}:NULL[:STATe]?

Enables or disables the null function for frequency and period measurements.

NOTE Unlike the SENSe:FREQuency and SENSe:PERiod range and aperture commands, this parameter is not shared between frequency and period measurements. The null parameters are independent for frequency and period measurements.

Parameter	Typical Return
{ON 1 OFF 0}. Default: OFF.	0 (OFF) or 1 (ON)
Configure frequency measurements, using the null function to subtract 1kHz from the measurements. Make and read two measurements: CONF:FREQ FREQ:NULL:STAT ON;VAL 1 kHz SAMP:COUN 2 READ? Typical Response: +1.04530000E+03,+1.04570000E+03	

- Enabling the scaling function also enables automatic null value selection ([\[SENSe:\]{FREQuency|PERiod}:NULL:VALue:AUTO ON](#)).
- To set a fixed null value, use: [\[SENSe:\]{FREQuency|PERiod}:NULL:VALue](#).
- The instrument disables the null function after a Factory Reset ([*RST](#)), Instrument Preset ([SYSTem:PRESet](#)), or CONFigure function.

[SENSe:]{FREQuency|PERiod}:NULL:VALue {<value>|MIN|MAX|DEF}
 [SENSe:]{FREQuency|PERiod}:NULL:VALue? [{MIN|MAX|DEF}]

Stores a null value for frequency and period measurements.

NOTE Unlike the SENSE:FREQuency and SENSE:PERiod range and aperture commands, this parameter is not shared between frequency and period measurements. The null parameters are independent for frequency and period measurements.

Parameter	Typical Return
Frequency: -1.2E6 to +1.2E6. Default: 0. Period: -1.2 to +1.2 seconds. Default: 0.	+1.00000000E-02
Configure frequency measurements, using the null function to subtract 1 kHz from the measurements. Make and read two measurements: CONF:FREQ FREQ:NULL:STAT ON;VAL 1 kHz SAMP:COUN 2 READ? Typical Response: +1.04530000E+03,+1.04570000E+03	

- Specifying a null value disables automatic null value selection ([SENSe:]{FREQuency|PERiod}:NULL:VALue:AUTO OFF).
- To use the null value, the null state must be on ([SENSe:]{FREQuency|PERiod}:NULL:STATe ON).
- This parameter is set to its default value after a Factory Reset (*RST), Instrument Preset (SYSTEM:PRESet), or CONFIGure function.

[SENSe:]{FREQuency|PERiod}:NULL:VALue:AUTO {ON|1|OFF|0}
 [SENSe:]{FREQuency|PERiod}:NULL:VALue:AUTO?

Enables or disables automatic null value selection for frequency and period measurements.

NOTE Unlike the SENSE:FREQuency and SENSE:PERiod range and aperture commands, this parameter is not shared between frequency and period measurements. The null parameters are independent for frequency and period measurements.

Parameter	Typical Return
{ON 1 OFF 0}. Default: OFF.	0 (OFF) or 1 (ON)
Configure frequency measurements, using the null function to subtract 1 kHz from them. Make and read two measurements: CONF:FREQ FREQ:NULL:STAT ON;VAL 1 kHz SAMP:COUN 2 READ? Typical Response: +1.04530000E+00,+1.04570000E+00 Make a second set of measurements using automatic null value selection: FREQ:NULL:VAL:AUTO ON READ? Typical Response: +0.00000000E+00,+0.01420000E+00	

- When automatic reference selection is ON, the first measurement made is used as the null value for all subsequent measurements. `[SENSe:]{FREQuency|PERiod}:NULL:VALue` is set to this value. Automatic null value selection will be disabled.
- When automatic null value selection is disabled (OFF), the null value is specified by: `[SENSe:]{FREQuency|PERiod}:NULL:VALue`.
- The instrument enables automatic null value selection when the null function is enabled (`[SENSe:]{FREQuency|PERiod}:NULL:STATe ON`).
- This parameter is set to its default value after a Factory Reset (`*RST`), Instrument Preset (`SYSTem:PRESet`), or CONFigure function.

`[SENSe:]{FREQuency|PERiod}:RANGe:LOWer {<freq>|MIN|MAX|DEF}`
`[SENSe:]{FREQuency|PERiod}:RANGe:LOWer? [{MIN|MAX|DEF}]`

Sets the AC bandwidth used to detect the signal during frequency and period measurements.

NOTE This parameter is shared between frequency and period measurements. Setting or querying the parameter with the FREQuency version of this command is identical to setting or querying it with the PERiod version.

The instrument uses three different AC filters that enable you either to optimize low frequency accuracy or to achieve faster AC settling times following a change in input signal amplitude. The instrument selects the slow (3 Hz), medium (20 Hz) or fast (200 Hz) filter based on the cutoff frequency specified by this command. Specify the lowest frequency that you expect to encounter.

Parameter	Typical Return
{3 Hz 20 Hz 200 Hz}. Default: 20Hz.	+6.27530000E+03
Make and read a frequency measurement. Use the 3 Hz filter bandwidth:	
CONF:FREQ	
FREQ:RANG:LOW 3	
READ?	

- If you enter the lowest expected frequency that you intend to encounter, the command will select the appropriate <filter>. For example, if you enter 15 Hz, the slow filter (3 Hz) is selected. If you enter 190 Hz, the medium filter (20 Hz) is selected to provide the appropriate low cutoff.
- Set the lowest frequency that you expect to encounter. Lower bandwidths result in longer settling delays, as shown:

Input Frequency	Default Settling Delay
3 Hz - 300 kHz (<i>Slow</i>)	1.66 s/measurement
20 Hz - 300 kHz (<i>Medium</i>)	0.25 s/measurement
200 Hz - 300 kHz (<i>Fast</i>)	0.025 s/measurement

- This parameter is set to its default value after a Factory Reset (`*RST`) or Instrument Preset (`SYSTem:PRESet`).

[SENSe:]{FREQuency|PERiod}:TIMeout:AUTO {ON|1|OFF|0}
 [SENSe:]{FREQuency|PERiod}:TIMeout:AUTO?

Controls how long the instrument waits before timing out on a frequency or period measurement when no signal is present.

Parameter	Typical Return
{ON 1 OFF 0}. Default: OFF.	0 (OFF) or 1 (ON)
Configure frequency measurements, using the null function to subtract 1kHz from the measurements. Enable the automatic timeout. Make and read two measurements: CONF:FREQ FREQ:NULL:STAT ON;VAL 1 kHz TIM:AUTO ON SAMP:COUN 2 READ? Typical Response: +1.04530000E+03,+1.04570000E+03	

- When set to OFF, the instrument waits 1 second before timing out. When set to ON, the wait time varies with AC filter bandwidth; for the faster bandwidths, the instrument waits a shorter time before timing out and returning 0.0. This is advantageous in manufacturing test systems where a DUT failure may result in no signal; in this case, the failure can be detected sooner, speeding up test throughput.
- This setting is non-volatile; it will not be changed by power cycling or [*RST](#) or [SYSTem:PRESet](#).

[SENSe:]{FREQuency|PERiod}:VOLTage:RANGe {<range>|MIN|MAX|DEF}
 [SENSe:]{FREQuency|PERiod}:VOLTage:RANGe? [{MIN|MAX|DEF}]

Selects a fixed *voltage* range for frequency and period measurements.

NOTE This parameter is shared between frequency and period measurements. Setting or querying the parameter with the FREQuency version of this command is identical to setting or querying it with the PERiod version.

WARNING The maximum range parameter (MAX) is 1000 V. However, the SAFETY LIMIT on the front and rear HI/LO input terminals is 750 VAC (rms). The rms voltage is waveform dependent. A sine wave is limited to 750 VAC (rms), but a 1000 Vpk square wave is safe. Connection to AC mains power is further limited to CAT II (300 V). See [Safety and Regulatory Information](#) for more information on the safety features and the safe operation of this instrument.

Parameter	Typical Return
<range>: {100 mV 1 V 10 V 100 V 1000 V}. Default: 10V	+1.04530000E+03
Configures frequency measurements using the 10 VAC range. Make and read two measurements: CONF:FREQ FREQ:VOLT:RANG 10 SAMP:COUN 2 READ?	

- The input signal for frequency or period measurements has an *AC voltage* component. Use this command to select a fixed *voltage* range for frequency and period measurements. Use [\[SENSe:\]{FREQuency|PERiod}:VOLTage:RANGe:AUTO](#) to disable or enable voltage autoranging or use [CONFigure:{FREQuency|PERiod}](#) to select voltage autoranging by default.
- Selecting a fixed range ([SENSe:]<function>:RANGe) disables autoranging.
- If the input voltage is too large for the selected voltage range (manual ranging), the instrument displays the word Overload on the front panel and returns "9.9E37" from the remote interface. Autoranging can be enabled for the input voltage.
- This parameter is set to its default value after a Factory Reset ([*RST](#)) or Instrument Preset ([SYSTem:PRESet](#)).

[SENSe:]{FREQuency|PERiod}:VOLTage:RANGe:AUTO {OFF|ON|ONCE}
 [SENSe:]{FREQuency|PERiod}:VOLTage:RANGe:AUTO?

Disables or enables *voltage* autoranging for frequency and period measurements. Autoranging is convenient because it automatically selects the range for each measurement based on the input signal.

Specifying ONCE performs an immediate autorange and then turns autoranging off.

NOTE This parameter is shared between frequency and period measurements. Setting or querying the parameter with the FREQuency version of this command is identical to setting or querying it with the PERiod version.

WARNING The maximum range parameter (MAX) is 1000 V. However, the SAFETY LIMIT on the front and rear HI/LO input terminals is 750 VAC (rms). The rms voltage is waveform dependent. A sine wave is limited to 750 VAC (rms), but a 1000 Vpk square wave is safe. Connection to AC mains power is further limited to CAT II (300 V). See [Safety and Regulatory Information](#) for more information on the safety features and the safe operation of this instrument.

Parameter	Typical Return
{OFF ON ONCE}. Default: ON.	0 (OFF) or 1 (ON)
Configure frequency measurements and perform an immediate AC voltage autorange. Make and read two measurements: CONF:FREQ FREQ:VOLT:RANG:AUTO ONCE SAMP:COUN 2 READ? Typical Response: +1.04530000E+03,+1.04570000E+03	

- The input signal for frequency or period measurements has an *AC voltage* component. Use this command to disable or enable voltage autoranging or use [CONFigure:{FREQuency|PERiod}](#) to select voltage autoranging by default. Use [\[SENSe:\]{FREQuency|PERiod}:VOLTage:RANGe](#) to select a fixed voltage range for frequency and period measurements.
- Autoranging goes down a range at less than 10% of range and up a range at greater than 120% of range.
- Selecting a fixed range ([SENSe:]<function>:RANGe) disables autoranging.
- This parameter is set to its default value after a Factory Reset ([*RST](#)) or Instrument Preset ([SYSTem:PRESet](#)).

[SENSe:]FREQuency:SECOndary {"OFF"|"CALCulate:DATA"|"PERiod"|"VOLTage:AC"}
 [SENSe:]FREQuency:SECOndary?

Selects the secondary measurement function for frequency measurements.

Parameter	Typical Return
{"OFF" "CALCulate:DATA" "PERiod" "VOLTage:AC"}, default "OFF"	"CALC:DATA"
Configure frequency measurements, select period as the secondary measurement, make and retrieve measurements. CONF:FREQ MAX, MAX FREQ:SEC "PERiod" READ?;DATA2? Typical Response: +1.22230020E+02;+8.18129619E-03	

- "CALCulate:DATA" - (Applies only to the 34465A and 34470A.) The measurement value before any math operations are done (including NULL).
- "PERiod" - The period measurement of the input signal.
- "VOLTage:AC" - The AC voltage measurement of the input signal.
- This parameter is set to its default value after a Factory Reset (***RST**) or Instrument Preset (**SYSTem:PRESet**).

[SENSe:]PERiod:SECOndary {"OFF"|"CALCulate:DATA"|"FREQuency"|"VOLTage:AC"}
 [SENSe:]PERiod:SECOndary?

Selects the secondary measurement function for period measurements.

Parameter	Typical Return
{"OFF" "CALCulate:DATA" "FREQuency" "VOLTage:AC"}, default "OFF"	"CALC:DATA"
Configure period measurements, select frequency as the secondary measurement, make and retrieve measurements. CONF:PER MAX, MAX PER:SEC "FREQ" READ?;DATA2? Typical Response: +8.90363477E-03;+1.12313682E+02	

- "CALCulate:DATA" - (Applies only to the 34465A and 34470A.) The measurement value before any math operations are done (including NULL).
- "FREQuency" - The frequency measurement of the input signal.
- "VOLTage:AC" - The AC voltage measurement of the input signal.
- This parameter is set to its default value after a Factory Reset (***RST**) or Instrument Preset (**SYSTem:PRESet**).

[SENSe:]{RESistance|FRESistance} Subsystem

This subsystem configures two- and four-wire resistance measurements.

Command Summary

[SENSe:]{RESistance|FRESistance}:APERture

[SENSe:]{RESistance|FRESistance}:APERture:ENABled

[SENSe:]{RESistance|FRESistance}:NPLC

[SENSe:]{RESistance|FRESistance}:NULL[:STATe]

[SENSe:]{RESistance|FRESistance}:NULL:VALue

[SENSe:]{RESistance|FRESistance}:NULL:VALue:AUTO

[SENSe:]{RESistance|FRESistance}:OCOMpensated

[SENSe:]{RESistance|FRESistance}:POWER:LIMit[:STATe]

[SENSe:]{RESistance|FRESistance}:RANGe

[SENSe:]{RESistance|FRESistance}:RANGe:AUTO

[SENSe:]{RESistance|FRESistance}:RESolution

[SENSe:]{FRESistance|RESistance}:SECondary

[SENSe:]RESistance:ZERO:AUTO

[SENSe:]{RESistance|FRESistance}:APERture {<seconds>|MIN|MAX|DEF}
 [SENSe:]{RESistance|FRESistance}:APERture? [{MIN|MAX|DEF}]

Specifies the integration time in seconds (called *aperture time*) for resistance measurements.

NOTE Use this command for precise control of the DMM's integration time. Use NPLC (see [\[SENSe:\]FRESistance:NPLC](#)) for better power-line noise rejection characteristics (NPLC > 1)..

This parameter is common to 2-wire and 4-wire resistance measurements. Using the FRESistance version of this command or query is identical to using the RESistance version.

Parameter	Typical Return
(Without the DIG option) 200 μs to 1 s (2 μs resolution), default: 100 ms. (With the DIG option) 20 μs to 1 s (2 μs resolution), default: 100 ms.	+1.00000000E-01
Enable aperture, set aperture time to 300 milliseconds: RES:APER:ENAB ON RES:APER 300E-03 or FRES:APER:ENAB ON FRES:APER 300E-03	

- Applies only to the 34465A and 34470A.
- Affects both 2-wire and 4-wire resistance measurements.
- Both the [SENSe:]<function>:NPLC and [SENSe:]<function>:APERture commands control the instrument's integration time. When using both commands (not recommended), whichever command is sent last will override the other command and set the integration time. Sending the [SENSe:]<function>:APERture command sets the [SENSe:]<function>:APERture:ENABled command to 1 (ON); sending [SENSe:]<function>:NPLC sets it to 0 (OFF).
- This parameter is set to its default value after a Factory Reset ([*RST](#)) or Instrument Preset ([SYSTEM:PRESet](#)).

[SENSe:]{RESistance|FRESistance}:APERture:ENABled {ON|1|OFF|0}
 [SENSe:]{RESistance|FRESistance}:APERture:ENABled?

Enables the setting of integration time in seconds (called *aperture time*) for resistance measurements. If aperture time mode is disabled (default), the integration time is set in PLC (power-line cycles).

NOTE This parameter is common to 2-wire and 4-wire resistance measurements. Using the FRESistance version of this command or query is identical to using the RESistance version.

Parameter	Typical Return
{ON 1 OFF 0}. Default: OFF.	0 (OFF) or 1 (ON)
Enable aperture, set aperture time to 300 ms: RES:APER:ENAB ON RES:APER 300E-03 <i>or</i> FRES:APER:ENAB ON FRES:APER 300E-03	

- Applies only to the 34465A and 34470A.
- This query determines whether the aperture used for both 2-wire and 4-wire resistance measurements is enabled.
- The [CONFigure:FRESistance](#), [MEASure:FRESistance?](#), [\[SENSe:\]{RESistance|FRESistance}:NPLC](#), and [\[SENSe:\]{RESistance|FRESistance}:RESolution](#) commands disable the aperture time mode, and select an integration time in number of power line cycles.
- This parameter is set to its default value after a Factory Reset ([*RST](#)) or Instrument Preset ([SYSTem:PRESet](#)).

[SENSe:]{RESistance|FRESistance}:NPLC {<PLC>|MIN|MAX|DEF}
 [SENSe:]{RESistance|FRESistance}:NPLC? [{MIN|MAX|DEF}]

Sets the integration time in number of power line cycles (PLC) for all resistance measurements. Integration time is the period that the instrument's analog-to-digital (A/D) converter samples the input signal for a measurement. A longer integration time gives better measurement resolution but slower measurement speed.

NOTE This parameter is common to 2-wire and 4-wire resistance measurements. Using the FRESistance version of this command or query is identical to using the RESistance version.

Parameter	Typical Return
0.02, 0.2, 1, 10, 100. Default: 10 (34460A/61A) 0.02, 0.06, 0.2, 1, 10, 100. Default: 10 (34465A/70A without DIG option) 0.001, 0.002, 0.006, 0.02, 0.06, .2, 1, 10, 100. Default: 10 (34465A/70A with DIG option) See Range, Resolution and NPLC for more information.	+1.00000000E+01
Configure 4-wire resistance measurements using a 10 PLC integration time. Then make and read one measurement: CONF:FRES FRES:NPLC 10 READ? Typical Response: +6.27530000E+01	

- Selecting an integration time in power line cycles overrides an aperture set with the [\[SENSe:\]{RESistance|FRESistance}:APERture](#) command.
- Only integration times of 1, 10, or 100 PLC provide normal mode (line frequency noise) rejection.
- Setting the integration time also sets the measurement resolution. [Resolution Table](#) shows the relationship between integration time and resolution.
- This parameter is set to its default value after a Factory Reset ([*RST](#)) or Instrument Preset ([SYSTEM:PRESet](#)).

[SENSe:]{RESistance|FRESistance}:NULL[:STATe] {ON|1|OFF|0}
 [SENSe:]{RESistance|FRESistance}:NULL[:STATe]?

Enables or disables the null function for all resistance measurements.

NOTE This parameter is common to 2-wire and 4-wire resistance measurements. Using the FRESistance version of this command or query is identical to using the RESistance version.

Parameter	Typical Return
{ON 1 OFF 0}. Default: OFF.	0 (OFF) or 1 (ON)
Configure 2-wire resistance measurements, using the null function to remove 100 mΩ of wiring resistance. Make and read two measurements: CONF:RES RES:NULL:STAT ON;VAL .1 SAMP:COUN 2 READ? Typical Response: +1.04530000E+02,+1.04570000E+02	

- Enabling the scaling function also enables automatic null value selection ([SENSe: {RESistance|FRESistance}:NULL:VALue:AUTO ON](#)).
- To set a fixed null value, use: [\[SENSe:\]{RESistance|FRESistance}:NULL:VALue](#).
- The instrument disables the null function after a Factory Reset ([*RST](#)), Instrument Preset ([SYSTEM:PRESet](#)), or CONFigure function.

[SENSe:]{RESistance|FRESistance}:NULL:VALue {<value>|MIN|MAX|DEF}
 [SENSe:]{RESistance|FRESistance}:NULL:VALue? [{MIN|MAX|DEF}]

Stores a null value for all resistance measurements.

NOTE This parameter is common to 2-wire and 4-wire resistance measurements. Using the FRESistance version of this command or query is identical to using the RESistance version.

Parameter	Typical Return
-120 MΩ to +120 MΩ. Default: 0. (34460A/61A) -1.2 GΩ to +1.2 GΩ. Default: 0. (34465A/70A)	+1.04530000E+02
Configure 2-wire resistance measurements, using the null function to remove 100 mΩ of wiring resistance. Make and read two measurements: CONF:RES RES:NULL:STAT ON;VAL .1 SAMP:COUN 2 READ? Typical Response: +1.04530000E+02,+1.04570000E+02	

- Specifying a null value disables automatic null value selection ([SENSe:]{RESistance|FRESistance}:NULL:VALue:AUTO OFF).
- To use the null value, the null state must be on ([SENSe:]{RESistance|FRESistance}:NULL:STATe ON).
- This parameter is set to its default value after a Factory Reset (*RST), Instrument Preset (SYSTEM:PRESet), or CONFigure function.

[SENSe:]{RESistance|FRESistance}:NULL:VALue:AUTO {ON|1|OFF|0}
 [SENSe:]{RESistance|FRESistance}:NULL:VALue:AUTO?

Enables or disables automatic null value selection for all resistance measurements.

NOTE This parameter is common to 2-wire and 4-wire resistance measurements. Using the FRESistance version of this command or query is identical to using the RESistance version.

Parameter	Typical Return
{ON 1 OFF 0}. Default: OFF.	0 (OFF) or 1 (ON)
Configure 2-wire resistance measurements, using the null function to remove 100 mΩ of wiring resistance. Make and read two measurements: CONF:RES RES:NULL:STAT ON;VAL .1 SAMP:COUN 2 READ? Typical Response: +1.04530000E+02,+1.04570000E+02 Make a second set of measurements using automatic null value selection: RES:NULL:VAL:AUTO ON READ? Typical Response: +0.00000000E+00,+0.01420000E+00	

- When automatic reference selection is ON, the first measurement made is used as the null value for all subsequent measurements. [SENSe:]{RESistance|FRESistance}:NULL:VALue is set to this value. Automatic null value selection will be disabled.
- When automatic null value selection is disabled (OFF), the null value is specified by: [SENSe:]{RESistance|FRESistance}:NULL:VALue.
- The instrument enables automatic null value selection when the null function is enabled ([SENSe:]{RESistance|FRESistance}:NULL:STATe ON).
- This parameter is set to its default value after a Factory Reset (*RST), Instrument Preset (SYSTEM:PRESet), or CONFigure function.

[SENSe:]{RESistance|FRESistance}:OCOMpensated {OFF|ON}
 [SENSe:]{RESistance|FRESistance}:OCOMpensated?

Enables or disables offset compensation. Offset compensation removes the effects of small dc voltages in the circuit being measured. The technique involves taking the difference between two resistance measurements, one with the current source set to the normal value, and one with the current source set to a lower value. Enabling Offset Compensation approximately doubles the reading time.

NOTE This parameter is common to 2-wire and 4-wire resistance measurements. Using the FRESistance version of this command or query is identical to using the RESistance version.

Parameter	Typical Return
{ON 1 OFF 0}. Default: OFF.	0 (OFF) or 1 (ON)
Configure low-power 2-wire resistance measurements. Enable offset compensation. Make and read two measurements: RES:POW:LIM ON RES:OCOM ON SAMP:COUN 2 READ? Typical Response: +4.05451008E-03,+4.97391062E-03	

- Applies only to the 34465A and 34470A.
- Affects both 2-wire and 4-wire resistance measurements.
- Applies only to resistance measurements on the 100Ω, 1 kΩ, 10 kΩ and 100 kΩ ranges.
- This parameter is set to its default value after a Factory Reset (***RST**) or Instrument Preset (**SYSTem:PRESet**).

[SENSe:]{RESistance|FRESistance}:POWer:LIMit[:STATe] {OFF|ON}
 [SENSe:]{RESistance|FRESistance}:POWer:LIMit[:STATe]?

Enables or disables low-power resistance measurements (either 2- or 4-wire).

NOTE This parameter is common to 2-wire and 4-wire resistance measurements. Using the FRESistance version of this command or query is identical to using the RESistance version.

Parameter	Typical Return
{ON 1 OFF 0}. Default: OFF.	0 (OFF) or 1 (ON)
Configure 4-wire resistance measurements using a 10 PLC integration time. Enable low-power 4-wire resistance measurements. Then make and read one measurement: CONF:FRES FRES:NPLC 10 FRES:POW:LIM ON READ? Typical Response: +6.27530000E+01	

- Applies only to the 34465A and 34470A.
- This parameter is set to its default value after a Factory Reset (***RST**) or Instrument Preset (**SYSTEM:PRESet**).
- Low-power resistance measurements apply to the 100Ω through 100kΩ ranges only. The 1 MΩ through 1 GΩ ranges source the same current (~.5 μA) regardless of the low-power setting.

[SENSe:]{RESistance|FRESistance}:RANGe {<range>|MIN|MAX|DEF}
 [SENSe:]{RESistance|FRESistance}:RANGe? [{MIN|MAX|DEF}]

Selects a fixed measurement range for all resistance measurements.

NOTE This parameter is common to 2-wire and 4-wire resistance measurements. Using the FRESistance version of this command or query is identical to using the RESistance version.

Parameter	Typical Return
{100 Ω 1 kΩ 10 kΩ 100 kΩ 1 MΩ 10 MΩ 100 MΩ 1 GΩ}. Default: 1 kΩ.	+1.00000000E+03
Configure 2-wire resistance measurements using the 10 kΩ range. Then make and read one measurement: CONF:RES RES:RANG 10E3 READ? Typical Response: +6.27530000E+03	

- The 1 GΩ range applies only to the 34465A and 34470A.
- Selecting a fixed range ([SENSe:]<function>:RANGe) disables autoranging.
- If the input signal is greater than can be measured on the specified manual range, the instrument displays the word *Overload* on front panel and returns "9.9E37" from the remote interface.

See Also

[\[SENSe:\]{RESistance|FRESistance}:RANGe:AUTO](#)

[SENSe:]{RESistance|FRESistance}:RANGe:AUTO {OFF|ON|ONCE}

[SENSe:]{RESistance|FRESistance}:RANGe:AUTO?

Disables or enables autoranging for all resistance measurements. Autoranging is convenient because it automatically selects the range for each measurement based on the input signal. Specifying ONCE performs an immediate autorange and then turns autoranging off.

NOTE This parameter is common to 2-wire and 4-wire resistance measurements. Using the FRESistance version of this command or query is identical to using the RESistance version.

Parameter	Typical Return
{ON 1 OFF 0}. Default: ON.	0 (OFF) or 1 (ON)
Configure 2-wire resistance measurements and perform an immediate autorange. Make and read two measurements: CONF:RES RES:RANG:AUTO ONCE SAMP:COUN 2 READ? Typical Response: +1.04530000E+03,+1.04570000E+03	

- Autoranging goes down a range at less than 10% of range and up a range at greater than 120% of range.
- With autoranging enabled, the instrument selects the range based on the input signal.
- Selecting a fixed range ([SENSe:]<function>:RANGe) disables autoranging.
- This parameter is set to its default value after a Factory Reset ([*RST](#)) or Instrument Preset ([SYSTem:PRESet](#)).

[SENSe:]{RESistance|FRESistance}:RESolution {<resolution>|MIN|MAX|DEF}
 [SENSe:]{RESistance|FRESistance}:RESolution? [{MIN|MAX|DEF}]

Selects the measurement resolution for all resistance measurements. Specify the resolution in the same units as the selected measurement function, not in number of digits.

NOTE This parameter is common to 2-wire and 4-wire resistance measurements. Using the FRESistance version of this command or query is identical to using the RESistance version.

Parameter	Typical Return
<resolution>: See Resolution Table or Range, Resolution and NPLC . The default is equivalent to 10 PLC. Specify <resolution> in the measurement's units (V, A, Hz, Ω, and so on).	+3.00000000E+00
Configure 2-wire resistance measurements with a 3 Ω resolution. Then make and read one measurement: CONF:RES 1E6 RES:RES 3 READ? Typical Response: +6.27531500E+05	

- You can specify MIN (best resolution) or MAX (worst resolution) instead of <resolution>.
- To achieve normal mode (line frequency noise) rejection, use a resolution that corresponds to an integration time that is an integral number of power line cycles.
- This parameter is set to its default value after a Factory Reset ([*RST](#)) or Instrument Preset ([SYSTEM:PRESet](#)).

See Also

[\[SENSe:\]{RESistance|FRESistance}:NPLC](#)

[SENSe:]{FRESistance|RESistance}:SECOndary {"OFF"|"CALCulate:DATA"}
 [SENSe:]{FRESistance|RESistance}:SECOndary?

Selects the secondary measurement function for all resistance measurements.

Parameter	Typical Return
{"OFF" "CALCulate:DATA"}, default "OFF"	"CALC:DATA"
Configure resistance and secondary measurements. Make resistance measurement and retrieve secondary measurement. CONF:RES AUTO,MAX RES:SEC "CALC:DATA" READ?;DATA2? Typical Response: +3.01566373E-10;,+9.91000000E+3	

- "CALCulate:DATA" - (Applies only to the 34465A and 34470A.) The measurement value before any math operations are done (including NULL).
- Use [READ?](#) or [INITiate](#) to start the measurement. Use [\[SENSe:\]DATA2?](#) to retrieve the secondary measurement.
- This parameter is set to its default value after a Factory Reset ([*RST](#)) or Instrument Preset ([SYSTem:PRESet](#)).

[SENSe:]RESistance:ZERO:AUTO {OFF|ON|ONCE}

[SENSe:]RESistance:ZERO:AUTO?

Disables or enables the autozero mode for 2-wire resistance measurements.

- **ON (default):** the DMM internally measures the offset following each measurement. It then subtracts that measurement from the preceding reading. This prevents offset voltages present on the DMM’s input circuitry from affecting measurement accuracy.
- **OFF:** the instrument uses the last measured zero measurement and subtracts it from each measurement. It takes a new zero measurement each time you change the function, range or integration time.
- **ONCE:** the instrument takes one zero measurement and sets autozero OFF. The zero measurement taken is used for all subsequent measurements until the next change to the function, range or integration time. If the specified integration time is less than 1 PLC, the zero measurement is taken at 1 PLC to optimize noise rejection. Subsequent measurements are taken at the specified fast (< 1 PLC) integration time.

Parameter	Typical Return
{OFF ON ONCE}	0 (OFF) or 1 (ON)
Configure 2-wire resistance measurements and perform an immediate autozero. Make and read two measurements: CONF:RES 1E4 RES:ZERO:AUTO ONCE SAMP:COUN 2 READ? Typical Response: +1.04530000E+03,+1.04570000E+03	

- Does not affect 4-wire resistance measurements, which are always made with autozero ON.
- The autozero mode is set indirectly when you set the resolution and integration time using [CONFigure: {RESistance|FRESistance}](#) or [MEASure: {RESistance|FRESistance}?](#). Autozero is automatically turned OFF when you select an integration time less than 1 PLC with these commands.
- This parameter is set to its default value after a Factory Reset ([*RST](#)) or Instrument Preset ([SYSTEM:PRESet](#)).

[SENSe:]TEMPerature Subsystem

This subsystem configures temperature measurements.

Command Summary

[\[SENSe:\]TEMPerature:APERture](#)

[\[SENSe:\]TEMPerature:APERture:ENABLEd](#)

[\[SENSe:\]TEMPerature:NPLC](#)

[\[SENSe:\]TEMPerature:NULL\[:STATe\]](#)

[\[SENSe:\]TEMPerature:NULL:VALue](#)

[\[SENSe:\]TEMPerature:NULL:VALue:AUTO](#)

[\[SENSe:\]TEMPerature:SECondary](#)

[\[SENSe:\]TEMPerature:TRANsdUcer:{FRTD|RTD}:OCOMpensated](#)

[\[SENSe:\]TEMPerature:TRANsdUcer:{FRTD|RTD}:POWer:LIMit\[:STATe\]](#)

[\[SENSe:\]TEMPerature:TRANsdUcer:{FRTD|RTD}:RESistance\[:REFerence\]](#)

[\[SENSe:\]TEMPerature:TRANsdUcer:{FThermistor|THERmistor}:POWer:LIMit\[:STATe\]](#)

[\[SENSe:\]TEMPerature:TRANsdUcer:{FThermistor|THERmistor}:TYPE](#)

[\[SENSe:\]TEMPerature:TRANsdUcer:TCouple:CHECK](#)

[\[SENSe:\]TEMPerature:TRANsdUcer:TCouple:RJUNction](#)

[\[SENSe:\]TEMPerature:TRANsdUcer:TCouple:RJUNction:OFFSet:ADJust](#)

[\[SENSe:\]TEMPerature:TRANsdUcer:TCouple:RJUNction:TYPE](#)

[\[SENSe:\]TEMPerature:TRANsdUcer:TCouple:TYPE](#)

[\[SENSe:\]TEMPerature:TRANsdUcer:TYPE](#)

[\[SENSe:\]TEMPerature:ZERO:AUTO](#)

[SENSe:]TEMPerature:APERture {<seconds>|MIN|MAX|DEF}
 [SENSe:]TEMPerature:APERture? [{MIN|MAX|DEF}]

Specifies the integration time in seconds (called *aperture time*) for temperature measurements.

NOTE Use this command for precise control of the DMM's integration time. Use NPLC (see [\[SENSe:\]TEMPerature:NPLC](#)) for better power-line noise rejection characteristics (NPLC > 1).

Parameter	Typical Return
(Without the DIG option) 200 μs to 1 s (2 μs resolution), default: 100 ms. (With the DIG option) 20 μs to 1 s (2 μs resolution), default: 100 ms.	+1.0000000E-01
Enable aperture, set the aperture time to 300 ms: TEMP:APER:ENAB ON TEMP:APER 300E-03	

- Applies only to the 34465A and 34470A.
- Both the [SENSe:]<function>:NPLC and [SENSe:]<function>:APERture commands control the instrument's integration time. When using both commands (not recommended), whichever command is sent last will override the other command and set the integration time. Sending the [SENSe:]<function>:APERture command sets the [SENSe:]<function>:APERture:ENABLEd command to 1 (ON); sending [SENSe:]<function>:NPLC sets it to 0 (OFF).
- This parameter is set to its default value after a Factory Reset ([*RST](#)) or Instrument Preset ([SYSTem:PRESet](#)).

[SENSe:]TEMPerature:APERture:ENABLEd {ON|1|OFF|0}
 [SENSe:]TEMPerature:APERture:ENABLEd?

Enables the setting of integration time in seconds (called *aperture time*) for temperature measurements. If aperture time mode is disabled (default), the integration time is set in PLC (power-line cycles).

Parameter	Typical Return
{ON 1 OFF 0}. Default: OFF.	0 (OFF) or 1 (ON)
Enable aperture time mode, set the aperture time to 300 ms: TEMP:APER:ENAB ON TEMP:APER 300E-03	

- Applies only to the 34465A and 34470A.
- The [CONFigure:TEMPerature](#), [MEASure:TEMPerature?](#), and [\[SENSe:\]TEMPerature:NPLC](#) commands disable the aperture time mode, and select an integration time in number of power line cycles.
- This parameter is set to its default value after a Factory Reset ([*RST](#)) or Instrument Preset ([SYSTem:PRESet](#)).

[SENSe:]TEMPerature:NPLC {<PLC>|MIN|MAX|DEF}

[SENSe:]TEMPerature:NPLC? [{MIN|MAX|DEF}]

Sets the integration time in number of power line cycles (PLC) for temperature measurements. Integration time is the period that the instrument's analog-to-digital (A/D) converter samples the input signal for a measurement. A longer integration time gives better measurement resolution but slower measurement speed.

Parameter	Typical Return
0.02, 0.2, 1, 10, 100. Default: 10 (34460A/61A) 0.02, 0.06, 0.2, 1, 10, 100. Default: 10 (34465A/70A without DIG option) 0.001, 0.002, 0.006, 0.02, 0.06, .2, 1, 10, 100. Default: 10 (34465A/70A with DIG option) See Range, Resolution and NPLC for more information.	+1.00000000E+01
Configure 4-wire RTD measurements using a 10 PLC integration time. Then make and read one measurement: CONF:TEMP FRTD TEMP:NPLC 10 READ? Typical Response: +6.27530000E+01	

- Selecting an integration time in power line cycles overrides an aperture set with the [\[SENSe:\]TEMPerature:APERture](#) command.
- Only integration times of 1, 10, or 100 PLC provide normal mode (line frequency noise) rejection.
- Setting the integration time also sets the measurement resolution. [Resolution Table](#) shows the relationship between integration time and resolution.
- This parameter is set to its default value after a Factory Reset ([*RST](#)) or Instrument Preset ([SYSTem:PRESet](#)).

[SENSe:]TEMPerature:NULL[:STATe] {ON|1|OFF|0}
[SENSe:]TEMPerature:NULL[:STATe]?

Enables or disables the null function for temperature measurements.

Parameter	Typical Return
{ON 1 OFF 0}. Default: OFF.	0 (OFF) or 1 (ON)
Configure 4-wire RTD measurements, using the null function to subtract 25°. Make and read two measurements: CONF:TEMP RTD TEMP:NULL:STAT ON VAL 25;SAMP:COUN 2 READ? Typical Response: +1.04530000E+00,+1.04570000E+00	

- Enabling the scaling function also enables automatic null value selection ([\[SENSe:\]TEMPerature:NULL:VALue:AUTO ON](#)).
- To set a fixed null value, use: [\[SENSe:\]TEMPerature:NULL:VALue](#).
- The instrument disables the null function after a Factory Reset ([*RST](#)), Instrument Preset ([SYSTem:PRESet](#)), or CONFigure function.

[SENSe:]TEMPerature:NULL:VALue {<value>|MIN|MAX|DEF}
[SENSe:]TEMPerature:NULL:VALue? [{MIN|MAX|DEF}]

Stores a null value for temperature measurements.

Parameter	Typical Return
-1.0E15 to +1.0E15. Default: 0.	+2.50000000E+01
Configure 4-wire RTD measurements, using the null function to subtract 25°. Make and read two measurements: CONF:TEMP RTD TEMP:NULL:STAT ON VAL 25;SAMP:COUN 2 READ? Typical Response: +1.04530000E+00,+1.04570000E+00	

- Specifying a null value disables automatic null value selection ([\[SENSe:\]TEMPerature:NULL:VALue:AUTO OFF](#)).
- To use the null value, the null state must be on ([\[SENSe:\]TEMPerature:NULL:STATe ON](#)).
- This parameter is set to its default value after a Factory Reset ([*RST](#)), Instrument Preset ([SYSTem:PRESet](#)), or CONFigure function.

[SENSe:]TEMPerature:NULL:VALue:AUTO {ON|1|OFF|0}
 [SENSe:]TEMPerature:NULL:VALue:AUTO?

Enables or disables automatic null value selection for temperature measurements.

Parameter	Typical Return
{ON 1 OFF 0}. Default: OFF.	0 (OFF) or 1 (ON)
Configure temperature measurements, using the null function to subtract 25° from them. Make and read two measurements: CONF:TEMP RTD TEMP:NULL:STAT ON;VAL 25> SAMP:COUN 2 READ? Typical Response: +1.04530000E+00,+1.04570000E+00 Make a second set of measurements using automatic null value selection: TEMP:NULL:VAL:AUTO ON READ? Typical Response: +0.00000000E+00,+0.01420000E+00	

- When automatic reference selection is ON, the first measurement made is used as the null value for all subsequent measurements. [\[SENSe:\]TEMPerature:NULL:VALue](#) is set to this value. Automatic null value selection will be disabled.
- When automatic null value selection is disabled (OFF), the null value is specified by: [\[SENSe:\]TEMPerature:NULL:VALue](#).
- The instrument enables automatic null value selection when the null function is enabled ([\[SENSe:\]TEMPerature:NULL:STATe ON](#)).
- This parameter is set to its default value after a Factory Reset ([*RST](#)), Instrument Preset ([SYSTem:PRESet](#)), or CONFigure function.

[SENSe:]TEMPerature:SECondary {"OFF"|"CALCulate:DATA"|"SENSe:DATA"}
 [SENSe:]TEMPerature:SECondary?

Selects the secondary measurement function for temperature measurements.

Parameter	Typical Return
{"OFF" "CALCulate:DATA" "SENSe:DATA"}, default "OFF"	"CALC:DATA"
Configure a 4-wire RTD measurement. Select the raw sensor value (ohms in this example) as the secondary measurement. Make and retrieve measurements. CONF:TEMP FRTD,85 TEMP:SEC "SENS:DATA" READ?;DATA2? Typical Response: -6.95327319E-01;+9.97282173E+01	

- "CALCulate:DATA" - (Applies only to the 34465A and 34470A.) The measurement value before any math operations are done (including NULL).
- "SENSe:DATA" is the raw sensor value; resistance for thermistor/RTD, voltage and reference temperature for thermocouple (thermocouple measurements apply to the 34465A and 34470A only).
- Use [READ?](#) or [INITiate](#) to start the measurement.
- This parameter is set to its default value after a Factory Reset ([*RST](#)) or Instrument Preset ([SYSTem:PRESet](#)).

[SENSe:]TEMPerature:TRANsducer:{FRTD|RTD}:OCOMPensated {ON|1|OFF|0}
 [SENSe:]TEMPerature:TRANsducer:{FRTD|RTD}:OCOMPensated?

Enables or disables offset compensation for 2-wire and 4-wire RTD measurements.

Offset compensation removes the effects of small dc voltages in the circuit being measured. The technique involves taking the difference between two resistance measurements, one with the current source set to the normal value, and one with the current source set to a lower value.

NOTE This parameter is common to 2-wire and 4-wire resistance measurements. Using the FRTD version of this command or query is identical to using the RTD version.

Parameter	Typical Return
{ON 1 OFF 0}. Default: OFF.	0 (OFF) or 1 (ON)
Configure offset-compensated 2-wire RTD measurements. Make and read two measurements: CONF:TEMP RTD TEMP:TRANS:RTD:POW:LIM ON TEMP:TRANS:RTD:OCOM ON SAMP:COUN 2 READ? Typical Response: +1.05451008E+01,+1.07391062E+01	

- Applies only to the 34465A and 34470A.
- Affects both 2-wire and 4-wire resistance measurements.
- This parameter is set to its default value after a Factory Reset (***RST**) or Instrument Preset (**SYSTem:PRESet**).

[SENSe:]TEMPerature:TRANsducer:{FRTD|RTD}:POWer:LIMit[:STATe] {ON|1|OFF|0}
 [SENSe:]TEMPerature:TRANsducer:{FRTD|RTD}:POWer:LIMit[:STATe]?

Enables or disables low-power, 2-wire or 4-wire, RTD measurements.

NOTE This parameter is common to 2-wire and 4-wire RTD measurements. Using the FRTD version of this command or query is identical to using the RTD version.

Parameter	Typical Return
{ON 1 OFF 0}. Default: OFF.	0 (OFF) or 1 (ON)
Configure offset-compensated 2-wire RTD measurements. Make and read two measurements: CONF:TEMP RTD TEMP:TRANS:RTD:POW:LIM ON TEMP:TRANS:RTD:OCOM ON SAMP:COUN 2 READ? Typical Response: +1.05451008E+01,+1.07391062E+01	

- Applies only to the 34465A and 34470A.
- This parameter is set to its default value after a Factory Reset (***RST**) or Instrument Preset (**SYSTem:PRESet**).

[SENSe:]TEMPerature:TRANsducer:{FRTD|RTD}:RESistance[:REFerence] {<reference>|MIN|MAX|DEF}
 [SENSe:]TEMPerature:TRANsducer:{FRTD|RTD}:RESistance[:REFerence]? [{MIN|MAX|DEF}]

Selects the nominal resistance (R_0) for 2-wire and 4-wire RTD measurements. R_0 is the nominal resistance of an RTD at 0 °C.

Parameter	Typical Return
34460A/61A: 80 Ω to 120 Ω. Default: 100 Ω. 34465A/70A: 49 Ω to 2100 Ω. Default: 100 Ω.	+1.00100000E+02
Configure 4-wire RTD measurements using an RTD with an R_0 of 100.1 Ω. Make and read two measurements: CONF:TEMP FRTD TEMP:TRAN:FRTD:RES 100.1 SAMP:COUN 2 READ? Typical Response: +1.04530000E+02,+1.04570000E+02	

- This parameter is set to its default value after a Factory Reset (***RST**) or Instrument Preset (**SYSTem:PRESet**).

[SENSe:]TEMPerature:TRANsducer:{FTHermistor|THERmistor}:POWer:LIMit[:STATe] {ON|1|OFF|0}
 [SENSe:]TEMPerature:TRANsducer:{FTHermistor|THERmistor}:POWer:LIMit[:STATe]?

Enables or disables low-power thermistor measurements (either 2- or 4-wire).

Parameter	Typical Return
{ON 1 OFF 0}. Default: OFF.	0 (OFF) or 1 (ON)
Configure 4-wire thermistor measurements. Enable low-power thermistor measurements. Make and read two measurements: CONF:TEMP FTH TEMP:TRAN:FTH:TYPE 5000 TEMP:TRAN:FTH:POW:LIM ON SAMP:COUN 2 READ? Typical Response: +1.04530000E+02,+1.04570000E+02	

- Applies only to the 34465A and 34470A.
- Only integration times of 1, 10, or 100 PLC provide normal mode (line frequency noise) rejection.
- Setting the integration time also sets the measurement resolution. [Resolution Table](#) shows the relationship between integration time and resolution.
- This parameter is set to its default value after a Factory Reset (***RST**) or Instrument Preset (**SYSTem:PRESet**).

[SENSe:]TEMPerature:TRANsducer:TYPE {FRTD|RTD|FTHermistor|THERmistor|TCouple}
 [SENSe:]TEMPerature:TRANsducer:TYPE?

Selects the transducer probe type to use for temperature measurements. The supported probes are 2-wire and 4-wire RTDs, 2-wire and 4-wire thermistors (5 k 44007 type, see Thermistor Requirements below), and, for the 34465A/70A only, type E, J, K, N, R, or T thermocouples.

Parameter	Typical Return
{FRTD RTD FTHermistor THERmistor TCouple}. Default: FRTD.	FRTD, RTD, FTH, TC, or THER
Configure 2-wire RTD measurements using an RTD with an R_0 of 100.1 Ω . Make and read two measurements: FUNC "TEMP" TEMP:TRAN:TYPE RTD TEMP:TRAN:FRTD:RES 100.1 SAMP:COUN 2 READ? Typical Response: +2.54530000E+01,+2.54570000E+01	

- TCouple applies only to the 34465A and 34470A.
- This parameter is set to its default value after a Factory Reset (***RST**) or Instrument Preset (**SYSTem:PRESet**).

[SENSe:]TEMPerature:TRANsducer:TCouple:CHECK {ON|1|OFF|0}

[SENSe:]TEMPerature:TRANsducer:TCouple:CHECK?

Disables or enables the *thermocouple check* feature to verify that your thermocouples are properly connected for measurements. When enabled, the instrument measures the resistance after each thermocouple measurement to ensure a proper connection. If an open connection is detected (greater than 5 kΩ on the 10 kΩ range), the instrument reports an overload condition.

Parameter	Typical Return
{ON 1 OFF 0}. Default: OFF.	0 (OFF) or 1 (ON)
Configure K-type thermocouple measurements. Select fixed reference junction and set reference junction temperature to +20 °C. Enable thermocouple check. Make and read two measurements: CONF:TEMP TC,K TEMP:TRAN:TC:RJUN:TYPE FIX TEMP:TRAN:TC:RJUN 20.0 TEMP:TRAN:TC:CHEC ON SAMP:COUN 2 READ? Typical Response: +3.31785468E+00,+3.61554515E+00	

- Applies only to the 34465A and 34470A.
- Enabling the thermocouple check feature slows measurement rates because two measurements have to be made for each temperature measurement values produced.
- This parameter is set to its default value after a Factory Reset (***RST**) or Instrument Preset (**SYSTem:PRESet**).

[SENSe:]TEMPerature:TRANsducer:TCouple:RJUNction {<temperature>|MIN|MAX|DEF}

[SENSe:]TEMPerature:TRANsducer:TCouple:RJUNction? [{MIN|MAX|DEF}]

Sets the *fixed* reference junction temperature in degrees Celsius for thermocouple measurements.

Parameter	Typical Return
-20 °C to +80 °C. Default: 0 °C.	+2.00000000E+01 (always in degrees Celsius).
Configure K-type thermocouple measurements. Select fixed reference junction and set reference junction temperature to +20 °C. Enable thermocouple check. Make and read two measurements: CONF:TEMP TC,K TEMP:TRAN:TC:RJUN:TYPE FIX TEMP:TRAN:TC:RJUN 20.0 TEMP:TRAN:TC:CHEC ON SAMP:COUN 2 READ? Typical Response: +3.31785468E+00,+3.61554515E+00	

- Applies only to the 34465A and 34470A.
- For this command, you must always specify the temperature in degrees Celsius regardless of the temperature units currently selected (see [UNIT:TEMPerature](#) command).
- This parameter is set to its default value after a Factory Reset (***RST**) or Instrument Preset (**SYSTem:PRESet**).

[SENSe:]TEMPerature:TRANsducer:TCouple:RJUNction:OFFSet:ADJust

{<temperature>|MIN|MAX|DEF}

[SENSe:]TEMPerature:TRANsducer:TCouple:RJUNction:OFFSet:ADJust? [{MIN|MAX|DEF}]

Allows you to make minor temperature adjustments to correct for the differences between the DMM internal temperature measurement of the front connection and the actual temperature of the measurement terminals.

Parameter	Typical Return
-20 °C to +20 °C. Default: 0 °C.	+2.00000000E+01
<p>Configure thermocouple temperature measurements using the internal reference junction. Measure the temperature inside the instrument. Assuming the temperature outside the instrument is 5 °C cooler than the inside measurement, adjust the temperature by -5 °C. Then make and read one measurement:</p> <pre>CONF:TEMP TC,K TEMP:TRAN:TC:RJUN:TYPE INT TEMP:TRAN:TC:CHEC ON SYST:TEMP? TEMP:TRAN:TC:RJUN:OFFS:ADJ -5 READ?</pre> <p>Typical Response: +3.31785468E+00</p>	

- Applies only to the 34465A and 34470A.
- **Important:** Since the internal reference temperature is the temperature of the *front* connections, use of the *rear* connections with the selection of the internal reference junction will have an unknown error with no specified performance and is not recommended.
- This parameter is set to its default value after a Factory Reset (***RST**) or Instrument Preset (**SYSTem:PRESet**).

[SENSe:]TEMPerature:TRANsducer:TCouple:RJUNction:TYPE {INTernal|FIXed}
 [SENSe:]TEMPerature:TRANsducer:TCouple:RJUNction:TYPE?

Thermocouple measurements require a reference junction temperature. For the reference junction temperature, you can use an *internal* measurement, or a known *fixed* junction temperature. This command selects the reference junction source for thermocouple measurements.

Parameter	Typical Return
{FIXed INTernal} default INT	FIX or INT
Configure K-type thermocouple measurements. Select fixed reference junction and set reference junction temperature to +20 °C. Enable thermocouple check. Make and read two measurements: CONF:TEMP TC,K TEMP:TRAN:TC:RJUN:TYPE FIX TEMP:TRAN:TC:RJUN 20.0 TEMP:TRAN:TC:CHEC ON SAMP:COUN 2 READ? Typical Response: +3.31785468E+00,+3.61554515E+00	

- Applies only to the 34465A and 34470A.
- **Important:** Since the internal reference temperature is the temperature of the *front* connections, use of the *rear* connections with the selection of the internal reference junction will have an unknown error with no specified performance and is not recommended.
- The accuracy of the measurement is highly dependent upon the thermocouple connections and the type of reference junction used. Use a *fixed* temperature reference for the highest accuracy measurements (you must maintain the known junction temperature).
- If you select a *fixed* reference junction source, you can specify a value between -20 °C and +80 °C using the [\[Sense:\]TEMPerature:TRANsducer:TCouple:RJUNction](#) command. You must always specify the temperature in degrees Celsius regardless of the temperature units currently selected (see [UNIT:TEMPerature](#) command).
- You can read the internal reference junction temperature using the [SYSTem:TEMPerature](#) command.
- This parameter is set to its default value after a Factory Reset ([*RST](#)) or Instrument Preset ([SYSTem:PRESet](#)).

[SENSe:]TEMPerature:TRANsducer:TCouple:TYPE {E|J|K|N|R|T}
 [SENSe:]TEMPerature:TRANsducer:TCouple:TYPE?

Selects the thermocouple type for thermocouple measurements.

Parameter	Typical Return
{E J K N R T} default J	E, J, K, N, R, or T
Configure K-type thermocouple measurements. Select fixed reference junction and set reference junction temperature to +20 °C. Enable thermocouple check. Make and read two measurements: CONF:TEMP TC,K TEMP:TRAN:TC:RJUN:TYPE FIX TEMP:TRAN:TC:RJUN 20.0 TEMP:TRAN:TC:CHEC ON SAMP:COUN 2 READ? Typical Response: +3.31785468E+00,+3.61554515E+00	

- Applies only to the 34465A and 34470A.
- Thermocouple measurements require a reference junction temperature (see [\[SENSe:\]TEMPerature:TRANsducer:TCouple:RJUNction:TYPE](#) command). For the reference junction temperature, you can use an *internal* measurement, or a known *fixed* junction temperature. By default, an internal reference junction temperature is used.
- This parameter is set to its default value after a Factory Reset ([*RST](#)) or Instrument Preset ([SYSTEM:PRESet](#)).

[SENSe:]TEMPerature:TRANsducer:{FTHermistor|THERmistor}:TYPE 5000
 [SENSe:]TEMPerature:TRANsducer:{FTHermistor|THERmistor}:TYPE?

Selects the thermistor type for 2-wire and 4-wire temperature measurements. Choosing the THERmistor or the FTHermistor command form makes no difference, as both commands affect the same parameter.

Parameter	Typical Return
5000 (only available choice)	+5000
Configure 4-wire thermistor measurements. Make and read two measurements: CONF:TEMP FTH TEMP:TRAN:FTH:TYPE 5000 SAMP:COUN 2 READ? Typical Response: +1.04530000E+02,+1.04570000E+02	

[SENSe:]TEMPerature:ZERO:AUTO {OFF|ON|ONCE}

[SENSe:]TEMPerature:ZERO:AUTO?

Disables or enables the autozero mode for 2-wire temperature measurements.

- **ON (default):** the DMM internally measures the offset following each measurement. It then subtracts that measurement from the preceding reading. This prevents offset voltages present on the DMM’s input circuitry from affecting measurement accuracy.
- **OFF:** the instrument uses the last measured zero measurement and subtracts it from each measurement. It takes a new zero measurement each time you change the function, range or integration time.
- **ONCE:** the instrument takes one zero measurement and sets autozero OFF. The zero measurement taken is used for all subsequent measurements until the next change to the function, range or integration time. If the specified integration time is less than 1 PLC, the zero measurement is taken at 1 PLC to optimize noise rejection. Subsequent measurements are taken at the specified fast (< 1 PLC) integration time.

Parameter	Typical Return
{OFF ON ONCE}. Default: ON.	0 (OFF) or 1 (ON)
Configure 2-wire RTD measurements and perform an immediate zero autozero. Make and read two measurements: CONF:TEMP RTD TEMP:ZERO:AUTO ONCE SAMP:COUN 2 READ? Typical Response: +2.57530000E+01,+2.57570000E+01	

- Does not affect 4-wire resistance measurements, which are always made with autozero ON.
- The autozero mode is set indirectly when you set the resolution and integration time using [CONFig-ure:TEMPerature](#) or [MEASure:TEMPerature?](#). Autozero is automatically turned OFF when you select an integration time less than 1 PLC with these commands.
- This parameter is set to its default value after a Factory Reset ([*RST](#)) or Instrument Preset ([SYSTem:PRESet](#)).

[SENSe:]VOLTage Subsystem

This subsystem configures AC voltage, DC voltage, and ratio measurements.

Command Summary

[\[SENSe:\]VOLTage:AC:BANDwidth](#)

[\[SENSe:\]VOLTage:{AC|DC}:NULL\[:STATe\]](#)

[\[SENSe:\]VOLTage:{AC|DC}:NULL:VALue](#)

[\[SENSe:\]VOLTage:{AC|DC}:NULL:VALue:AUTO](#)

[\[SENSe:\]VOLTage:{AC|DC}:RANGe](#)

[\[SENSe:\]VOLTage:{AC|DC}:RANGe:AUTO](#)

[\[SENSe:\]VOLTage:AC:SECondary](#)

[\[SENSe:\]VOLTage\[:DC\]:APERture](#)

[\[SENSe:\]VOLTage\[:DC\]:APERture:ENABled](#)

[\[SENSe:\]VOLTage\[:DC\]:IMPedance:AUTO](#)

[\[SENSe:\]VOLTage\[:DC\]:NPLC](#)

[\[SENSe:\]VOLTage\[:DC\]:RATio:SECondary](#)

[\[SENSe:\]VOLTage\[:DC\]:RESolution](#)

[\[SENSe:\]VOLTage\[:DC\]:SECondary](#)

[\[SENSe:\]VOLTage\[:DC\]:ZERO:AUTO](#)

[SENSe:]VOLTage:AC:BANDwidth {<filter>|MIN|MAX|DEF}
 [SENSe:]VOLTage:AC:BANDwidth? [{MIN|MAX|DEF}]

Sets the bandwidth for AC voltage measurements.

The instrument uses three different AC filters that enable you either to optimize low frequency accuracy or to achieve faster AC settling times following a change in input signal amplitude. The instrument selects the slow (3 Hz), medium (20 Hz) or fast (200 Hz) filter based on the cutoff frequency specified by this command. Specify the lowest frequency that you expect to encounter.

Parameter	Typical Return
{3 Hz 20 Hz 200 Hz}. Default: 20Hz.	+2.00000000E+01
Make and read an AC voltage measurement. Use the 3 Hz filter bandwidth: CONF:VOLT:AC 100 VOLT:AC:BAND 3 READ?	

- If you enter the lowest expected frequency that you intend to encounter, the command will select the appropriate <filter>. For example, if you enter 15 Hz, the slow filter (3 Hz) is selected. If you enter 190 Hz, the medium filter (20 Hz) is selected to provide the appropriate low cutoff.
- Set the lowest frequency that you expect to encounter. Lower bandwidths result in longer settling delays, as shown:

Input Frequency	Default Settling Delay
3 Hz - 300 kHz (<i>Slow</i>)	2.5000 s/measurement
20 Hz - 300 kHz (<i>Medium</i>)	0.6250 s/measurement
200 Hz - 300 kHz (<i>Fast</i>)	0.0250 s/measurement

- This parameter is set to its default value after a Factory Reset (***RST**) or Instrument Preset (**SYSTem:PRESet**).

[SENSe:]VOLTage:{AC|DC}:NULL[:STATe] {ON|1|OFF|0}
 [SENSe:]VOLTage:{AC|DC}:NULL[:STATe]?

Enables or disables the null function for AC or DC voltage measurements.

NOTE This parameter setting is not shared between AC and DC measurements. The parameters are independent for AC and DC measurements.

Parameter	Typical Return
{ON 1 OFF 0}. Default: OFF.	0 (OFF) or 1 (ON)
Configure AC voltage measurements, using the null function to subtract 100 mV from the measurements. Make and read two measurements: CONF:VOLT:AC VOLT:AC:NULL:STAT ON;VAL 100 mV SAMP:COUN 2 READ? Typical Response: +1.04530000E+00,+1.04570000E+00	

- Enabling the scaling function also enables automatic null value selection ([SENSe:]VOLTage:{AC|DC}:NULL:VALue:AUTO ON).
- To set a fixed null value, use: [SENSe:]VOLTage:{AC|DC}:NULL:VALue.
- The null function is not available for DC ratio measurements.
- The instrument disables the null function after a Factory Reset (*RST), Instrument Preset (SYSTEM:PRESet), or CONFIGure function.

[SENSe:]VOLTage:{AC|DC}:NULL:VALue {<value>|MIN|MAX|DEF}
 [SENSe:]VOLTage:{AC|DC}:NULL:VALue? [{MIN|MAX|DEF}]

Stores a null value for voltage measurements.

NOTE This parameter setting is not shared between AC and DC measurements. The parameters are independent for AC and DC measurements.

Parameter	Typical Return
-1200 to +1200 V. Default: 0.	+1.00000000E-02
Configure AC voltage measurements, using the null function to subtract 100 mV from the measurements. Make and read two measurements: CONF:VOLT:AC VOLT:AC:NULL:STAT ON;VAL 100 mV SAMP:COUN 2 READ? Typical Response: +1.04530000E+00,+1.04570000E+00	

- Specifying a null value disables automatic null value selection ([SENSe:]VOLTage:{AC|DC}:NULL:VALue:AUTO OFF).
- To use the null value, the null state must be on ([SENSe:]VOLTage:{AC|DC}:NULL:STATe ON).
- The null function is not available for DC ratio measurements.
- This parameter is set to its default value after a Factory Reset (*RST), Instrument Preset (SYSTem:PRESet), or CONFigure function.

[SENSe:]VOLTage:{AC|DC}:NULL:VALue:AUTO {ON|1|OFF|0}
 [SENSe:]VOLTage:{AC|DC}:NULL:VALue:AUTO?

Enables or disables automatic null value selection for AC voltage or DC voltage measurements.

NOTE This parameter setting is not shared between AC and DC measurements. The parameters are independent for AC and DC measurements.

Parameter	Typical Return
{ON 1 OFF 0}. Default: OFF.	0 (OFF) or 1 (ON)
Configure AC voltage measurements, using the null function to subtract 100 mV from the measurements. Make and read two measurements: CONF:VOLT:AC VOLT:AC:NULL:STAT ON;VAL 100 mV SAMP:COUN 2 READ? Typical Response: +1.04530000E+00,+1.04570000E+00 Make a second set of measurements using automatic null value selection: VOLT:AC:NULL:VAL:AUTO ON READ? Typical Response: +0.00000000E+00,+0.01420000E+00	

- When automatic reference selection is ON, the first measurement made is used as the null value for all subsequent measurements. [\[SENSe:\]VOLTage:{AC|DC}:NULL:VALue](#) is set to this value. Automatic null value selection will be disabled.
- When automatic null value selection is disabled (OFF), the null value is specified by: [\[SENSe:\]VOLTage:{AC|DC}:NULL:VALue](#).
- The instrument enables automatic null value selection when the null function is enabled ([\[SENSe:\]VOLTage:{AC|DC}:NULL:STATe ON](#)).
- The null function is not available for DC ratio measurements.
- This parameter is set to its default value after a Factory Reset ([*RST](#)), Instrument Preset ([SYSTem:PRESet](#)), or CONFigure function.

[SENSe:]VOLTage:{AC|DC}:RANGe {<range>|MIN|MAX|DEF}
 [SENSe:]VOLTage:{AC|DC}:RANGe? [{MIN|MAX|DEF}]

Selects a fixed measurement range for AC and DC voltage measurements and DC ratio measurements.

NOTE This parameter setting is not shared between AC and DC measurements. The parameters are independent for AC and DC measurements.

WARNING The maximum range parameter (MAX) is 1000 V. However, the SAFETY LIMIT on the front and rear HI/LO input terminals is 750 VAC (rms). The rms voltage is waveform dependent. A sine wave is limited to 750 VAC (rms), but a 1000 Vpk square wave is safe. Connection to AC mains power is further limited to CAT II (300 V). See [Safety and Regulatory Information](#) for more information on the safety features and the safe operation of this instrument.

Parameter	Typical Return
<range>: {100 mV 1 V 10 V 100 V 1000 V} AC default: 10 V DC default: 1000 V	+1.00000000E+01
Configure AC voltage measurements using the 100 V range. Make and read two measurements: CONF:VOLT:AC VOLT:AC:RANG 100 SAMP:COUN 2 READ? Typical Response: +3.24530000E+01,+3.24570000E+01	

- Selecting a fixed range ([SENSe:]<function>:RANGe) disables autoranging.
- If the input signal is greater than can be measured on the specified manual range, the instrument displays the word *Overload* on front panel and returns "9.9E37" from the remote interface.
- The instrument is set to the default range, with autoranging enabled ([\[SENSe:\]VOLTage:{AC|DC}:RANGe:AUTO ON](#)), after a Factory Reset ([*RST](#)) or an Instrument Preset ([SYSTem:PRESet](#)).

[SENSe:]VOLTage:{AC|DC}:RANGe:AUTO {OFF|ON|ONCE}
 [SENSe:]VOLTage:{AC|DC}:RANGe:AUTO?

Disables or enables autoranging for AC and DC voltage measurements and for DC ratio measurements. Autoranging is convenient because it automatically selects the range for each measurement based on the input signal.

Specifying ONCE performs an immediate autorange and then turns autoranging off.

NOTE This parameter setting is not shared between AC and DC measurements. The parameters are independent for AC and DC measurements.

WARNING The maximum range parameter (MAX) is 1000 V. However, the SAFETY LIMIT on the front and rear HI/LO input terminals is 750 VAC (rms). The rms voltage is waveform dependent. A sine wave is limited to 750 VAC (rms), but a 1000 Vpk square wave is safe. Connection to AC mains power is further limited to CAT II (300 V). See [Safety and Regulatory Information](#) for more information on the safety features and the safe operation of this instrument.

Parameter	Typical Return
{ON 1 OFF 0}. Default: ON.	0 (OFF) or 1 (ON)
Configure DC voltage measurements and perform an immediate autorange. Make and read two measurements: CONF:VOLT:AC VOLT:AC:RANG:AUTO ONCE SAMP:COUN 2 READ? Typical Response: +1.04530000E+01,+1.04570000E+01	

- Autoranging goes down a range at less than 10% of range and up a range at greater than 120% of range.
- With autoranging enabled, the instrument selects the range based on the input signal.
- Selecting a fixed range ([SENSe:]<function>:RANGe) disables autoranging.
- This parameter is set to its default value after a Factory Reset ([*RST](#)) or Instrument Preset ([SYSTEM:PRESet](#)).

[SENSe:]VOLTage:AC:SECOndary {"OFF"|"CALCulate:DATA"|"FREQuency"|"VOLTage[:DC]}
 [SENSe:]VOLTage:AC:SECOndary?

Selects the secondary measurement function for AC voltage measurements.

Parameter	Typical Return
{"OFF" "CALCulate:DATA" "FREQuency" "VOLTage[:DC]}, default "OFF"	"CALC:DATA"
Configure AC voltage measurements using the 100 V range. Select frequency as the secondary measurement. Make and retrieve measurements. CONF:VOLT:AC 100 VOLT:AC:SEC "FREQ" READ?;DATA2? Typical Response: +8.54530000E+01;+1.00000000E+03	

- "CALCulate:DATA" - (Applies only to the 34465A and 34470A.) The measurement value before any math operations are done (including NULL).
- "FREQuency" - The frequency measurement of the input signal.
- "VOLTage[:DC]" - The DC voltage measurement of the input signal. Applies only when using the instrument from the front panel. Setting is ignored for measurements made from a remote interface. If you require both AC and DC voltage measurements from remote, program each function separately, see [CONFigure\[:VOLTage\]:{AC|DC}](#).
- Use [READ?](#) or [INITiate](#) to start the measurement.
- This parameter is set to its default value after a Factory Reset ([*RST](#)) or Instrument Preset ([SYSTEM:PRESet](#)).

[SENSe:]VOLTage[:DC]:APERture {<seconds>|MIN|MAX|DEF}
 [SENSe:]VOLTage[:DC]:APERture? [{MIN|MAX|DEF}]

Specifies the integration time in seconds (called *aperture time*) for dc voltage measurements.

NOTE

Use this command for precise control of the DMM's integration time. Use NPLC (see [\[SENSe:\]VOLTage\[:DC\]:NPLC](#)) for better power-line noise rejection characteristics (NPLC > 1).

Parameter	Typical Return
(Without the DIG option) 200 μs to 1 s (2 μs resolution), default: 100 ms. (With the DIG option) 20 μs to 1 s (2 μs resolution), default: 100 ms.	+1.00000000E-01
Enable aperture time mode, set the aperture time to 300 ms: VOLT:APER:ENAB ON VOLT:DC:APER 300E-03	

- Applies only to the 34465A and 34470A.
- Both the [SENSe:]<function>:NPLC and [SENSe:]<function>:APERture commands control the instrument's integration time. When using both commands (not recommended), whichever command is sent last will override the other command and set the integration time. Sending the [SENSe:]<function>:APERture command sets the [SENSe:]<function>:APERture:ENABLEd command to 1 (ON); sending [SENSe:]<function>:NPLC sets it to 0 (OFF).
- This parameter is set to its default value after a Factory Reset (***RST**) or Instrument Preset (**SYSTem:PRESet**).

[SENSe:]VOLTage[:DC]:APERture:ENABLEd {ON|1|OFF|0}
 [SENSe:]VOLTage[:DC]:APERture:ENABLEd?

Enables the setting of integration time in seconds (called *aperture time*) for dc voltage measurements. If aperture time mode is disabled (default), the integration time is set in PLC (power-line cycles).

Parameter	Typical Return
{ON 1 OFF 0}. Default: OFF.	0 (OFF) or 1 (ON)
Enable aperture time mode, set the aperture time to 300 ms: VOLT:APER:ENAB ON VOLT:DC:APER 300E-03	

- Applies only to the 34465A and 34470A.
- The **CONFigure[:VOLTage][:DC]**, **MEASure[:VOLTage][:DC]?**, **[SENSe:]VOLTage[:DC]:NPLC**, and **[SENSe:]VOLTage[:DC]:RESolution** commands disable the aperture time mode, and select an integration time in number of power line cycles.
- This parameter is set to its default value after a Factory Reset (***RST**) or Instrument Preset (**SYSTem:PRESet**).

[SENSe:]VOLTage[:DC]:IMPedance:AUTO {ON|1|OFF|0}
 [SENSe:]VOLTage[:DC]:IMPedance:AUTO?

Disables or enables automatic input impedance mode for DC voltage and ratio measurements.

Parameter	Typical Return
{ON 1 OFF 0}. Default: OFF.	0 (OFF) or 1 (ON)
Make all DC voltage measurements with a 10 MΩ input impedance: VOLT:IMP:AUTO OFF	

- **OFF:** the input impedance for DC voltage measurements is fixed at 10 MΩ for all ranges to minimize noise pickup.
- **ON:** the input impedance for DC voltage measurements varies by range. It is set to "HI-Z" (>10 GΩ) for the 100 mV, 1 V, and 10 V ranges to reduce the effects of measurement loading errors on these lower ranges. The 100 V and 1000 V ranges remain at a 10 MΩ input impedance.
- The [CONFigure](#) and [MEASure?](#) commands automatically select "AUTO OFF".
- This parameter is set to its default value after a Factory Reset ([*RST](#)) or Instrument Preset ([SYSTEM:PRESet](#)).

[SENSe:]VOLTage[:DC]:NPLC {<PLC>|MIN|MAX|DEF}
 [SENSe:]VOLTage[:DC]:NPLC? [{MIN|MAX|DEF}]

Sets the integration time in number of power line cycles (PLC) for DC voltage and ratio measurements. Integration time is the period that the instrument's analog-to-digital (A/D) converter samples the input signal for a measurement. A longer integration time gives better measurement resolution but slower measurement speed.

Parameter	Typical Return
0.02, 0.2, 1, 10, 100. Default: 10 (34460A/61A) 0.02, 0.06, 0.2, 1, 10, 100. Default: 10 (34465A/70A without DIG option) 0.001, 0.002, 0.006, 0.02, 0.06, .2, 1, 10, 100. Default: 10 (34465A/70A with DIG option) See Range, Resolution and NPLC for more information.	+1.00000000E+01
Configure DC voltage measurements using a 10 PLC integration time. Then make and read one measurement: CONF:VOLT:DC VOLT:DC:NPLC 10 READ? Typical Response: +6.27530000E-01	

- Only integration times of 1, 10, or 100 PLC provide normal mode (line frequency noise) rejection.
- Setting the integration time also sets the measurement resolution. [Resolution Table](#) shows the relationship between integration time and resolution. See [\[SENSe:\]VOLTage\[:DC\]:RESolution](#).
- This parameter is set to its default value after a Factory Reset ([*RST](#)) or Instrument Preset ([SYSTEM:PRESet](#)).

[SENSe:]VOLTage[:DC]:RATio:SEConDary {"OFF"|"CALCulate:DATA"|"SENSe:DATA"}
 [SENSe:]VOLTage[:DC]:RATio:SEConDary?

Selects the secondary measurement function for DC ratio measurements.

Parameter	Typical Return
{"OFF" "CALCulate:DATA" "SENSe:DATA"}, default "OFF"	"CALC:DATA"
Configure the instrument for DC voltage ratio measurements using the 100 V range with 1 mV resolution. Select "SENSe:DATA" as the secondary measurement. Make and retrieve measurements. CONF:VOLT:DC:RAT 100,0.001 VOLT:RAT:SEC "SENS:DATA" READ?;DATA2? Typical Response: +1.05294698E+00;+2.10532098E+00,+1.99945584E+00	

- "CALCulate:DATA" - (Applies only to the 34465A and 34470A.) The measurement value before any math operations are done (including NULL).
- "SENSe:DATA" - The DC signal voltage and the DC reference voltage measurements.
- This parameter is set to its default value after a Factory Reset (***RST**) or Instrument Preset (**SYSTem:PRESet**).

[SENSe:]VOLTage[:DC]:RESolution {<resolution>|MIN|MAX|DEF}
 [SENSe:]VOLTage[:DC]:RESolution? [{MIN|MAX|DEF}]

Selects the measurement resolution for DC voltage and ratio measurements. Specify the resolution in the same units as the selected measurement function, not in number of digits.

Parameter	Typical Return
<resolution>: See Resolution Table or Range, Resolution and NPLC . The default is equivalent to 10 PLC. Specify <resolution> in the measurement's units (V, A, Hz, Ω, and so on).	+3.00000000E-05
Configure DC voltage measurements with a 3 μV resolution. Then make and read one measurement: CONF:VOLT:DC 1 VOLT:DC:RES 3E-6 READ?	

- You can specify MIN (best resolution) or MAX (worst resolution) instead of <resolution>.
- To achieve normal mode (line frequency noise) rejection, use a resolution that corresponds to an integration time that is an integral number of power line cycles.
- This parameter is set to its default value after a Factory Reset (***RST**) or Instrument Preset (**SYSTem:PRESet**).

[SENSe:]VOLTage[:DC]:SECondary {"OFF"|"CALCulate:DATA"|"VOLTage:AC"|"PTPeak"}
 [SENSe:]VOLTage[:DC]:SECondary?

Selects the secondary measurement function for DC voltage measurements.

Parameter	Typical Return
{ "OFF" "CALCulate:DATA" "VOLTage:AC" "PTPeak" }, default "OFF"	"CALC:DATA"
Configure DC voltage measurements using the 10 V range with 1 mV resolution. Select peak-to-peak as the secondary measurement. Make and retrieve measurements. CONF:VOLT:DC 10,0.001 VOLT:DC:SEC "PTP" READ?;DATA2? Typical Response: -3.44948894E-03;+9.91000000E+3,+9.91000000E+3	

- "CALCulate:DATA" - (Applies only to the 34465A and 34470A.) The measurement value before any math operations are done (including NULL).
- "VOLTage:AC" - The AC voltage measurement of the input signal. Applies only when using the instrument from the front panel. Setting is ignored for measurements made from a remote interface. If you require both AC and DC voltage measurements from remote, program each function separately, see [CONFigure\[:VOLTage\]:{AC|DC}](#).
- "PTPeak" - The peak-to-peak, maximum, and minimum values of the input signal.
- This parameter is set to its default value after a Factory Reset (***RST**) or Instrument Preset (**SYSTem:PRESet**).

[SENSe:]VOLTage[:DC]:ZERO:AUTO {OFF|ON|ONCE}
 [SENSe:]VOLTage[:DC]:ZERO:AUTO?

Disables or enables the autozero mode for DC voltage and ratio measurements.

- **ON (default):** the DMM internally measures the offset following each measurement. It then subtracts that measurement from the preceding reading. This prevents offset voltages present on the DMM’s input circuitry from affecting measurement accuracy.
- **OFF:** the instrument uses the last measured zero measurement and subtracts it from each measurement. It takes a new zero measurement each time you change the function, range or integration time.
- **ONCE:** the instrument takes one zero measurement and sets autozero OFF. The zero measurement taken is used for all subsequent measurements until the next change to the function, range or integration time. If the specified integration time is less than 1 PLC, the zero measurement is taken at 1 PLC to optimize noise rejection. Subsequent measurements are taken at the specified fast (< 1 PLC) integration time.

Parameter	Typical Return
{OFF ON ONCE}	0 (OFF) or 1 (ON)
Configure DC voltage measurements and immediately autozero. Make and read two measurements: CONF:VOLT:DC 1 VOLT:DC:ZERO:AUTO ONCE SAMP:COUN 2 READ? Typical Response: +1.04530000E+01,+1.04570000E+01	

- The autozero mode is set indirectly when you set the resolution and integration time using CONFigure:VOLTage:DC, CONFigure:VOLTage:DC:RATio, MEASure:VOLTage:DC?, or MEASure:VOLTage:DC:RATio?. Autozero is automatically turned OFF when you select an integration time less than 1 PLC with these commands.
- This parameter is set to its default value after a Factory Reset (***RST**) or Instrument Preset (**SYSTEM:PRESet**).

STATus Subsystem

Agilent 34460A/34461A/34465A/34470A Status System

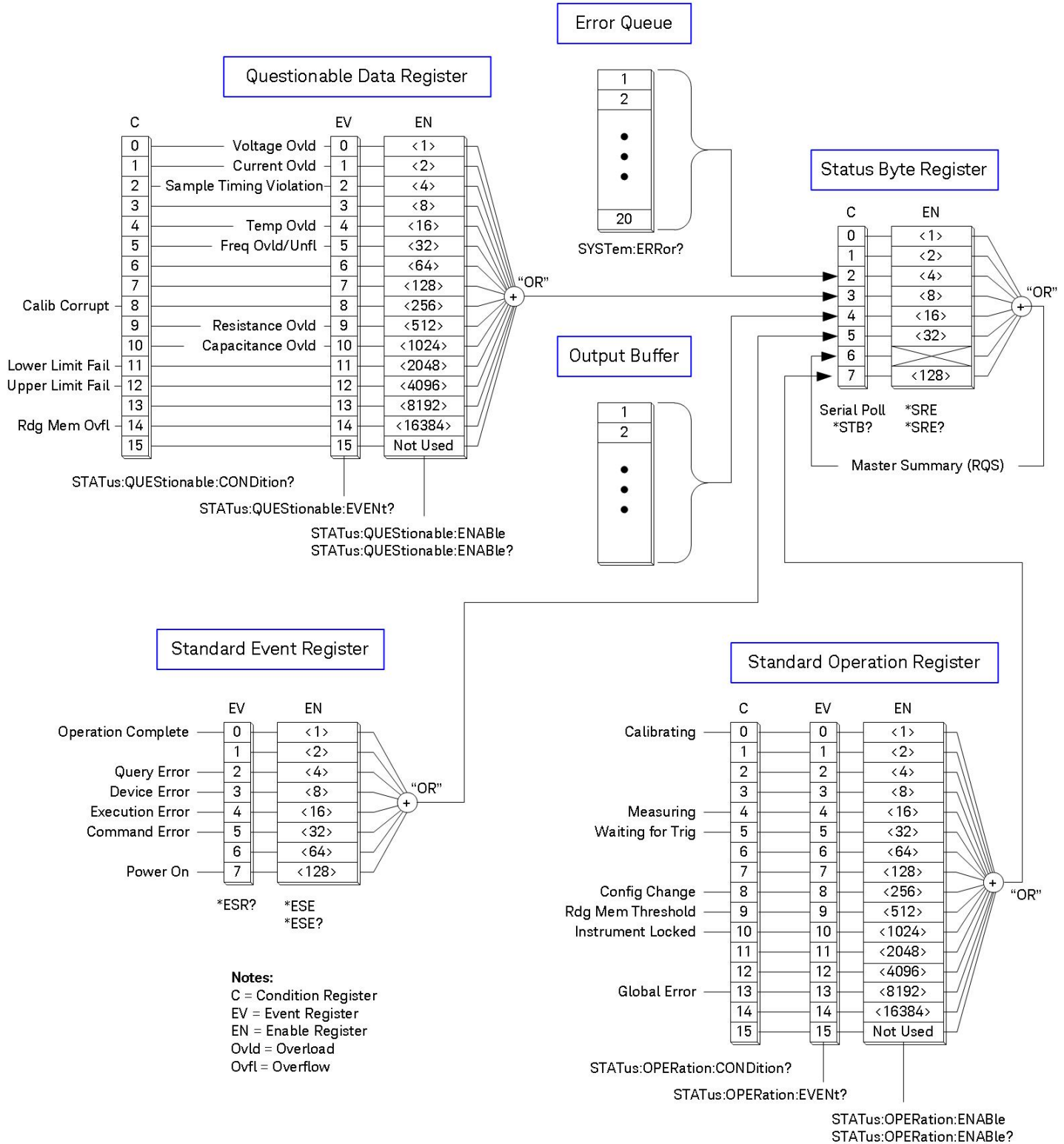

The following table lists the bit definitions for the *Questionable Data Register*:

NOTE The overload bits are set once per **INITiate** command. If you clear an overload bit, it is not set again until a new INITiate is sent.

Bit Number	Bit Name	Decimal Value	Definition
0	Voltage Overload	1	Only reported as event. Returns 0. Read the Event Register.
1	Current Overload	2	Only reported as event. Returns 0. Read the Event Register.
2	Sample Timing Violation	4	A sample timing violation has occurred involving the SAMPLE:TIMer command. Sample timing may not be valid. Applies only to the 34465A and 34470A.
3	Not Used	8	(Reserved for future use)
4	Temperature Overload	16	Only reported as event. Returns 0. Read the Event Register.
5	Frequency Overload/Underflow	32	Only reported as event. Returns 0. Read the Event Register.
6	Not Used	64	(Reserved for future use)
7	Not Used	128	(Reserved for future use)
8	Calibration Corrupt	256	At least one calibration constant is corrupt.
9	Resistance Overload	512	Only reported as event. Returns 0. Read the Event Register.
10	Capacitance Overload	1024	Only reported as event. Returns 0. Read the Event Register.
11	Lower Limit Failed	2048	The most recent measurement failed the lower limit test.
12	Upper Limit Failed	4096	The most recent measurement failed the upper limit test.
13	Not Used	8192	(Reserved for future use)
14	Memory Overflow	16384	Reading memory is full. One or more (oldest) measurements have been lost.
15	Not Used	32768	(Reserved for future use)

The following table lists the bit definitions for the *Standard Operation Register*:

Bit Number	Bit Name	Decimal Value	Definition
0	Calibrating	1	Instrument is performing a calibration.
1	Not Used	2	(Reserved for future use)
2	Not Used	4	(Reserved for future use)
3	Not Used	8	(Reserved for future use)
4	Measuring	16	Instrument is initiated, and is making or about to make a measurement.
5	Waiting for Trigger	32	Instrument is waiting for a trigger.
6	Not Used	64	(Reserved for future use)
7	Not Used	128	(Reserved for future use)
8	Configuration Change	256	Instrument configuration has been changed since the last INIT, READ? or MEASure?, either from the front panel or from SCPI.
9	Memory Threshold	512	Programmed number of measurements (DATA:POINTs:EVENT:THREshold) have been stored in measurement memory.
10	Instrument Locked	1024	Set if a remote interface (GPIB, USB or LAN) has a lock (SYSTem:LOCK:REQuest?). Cleared when the remote interface releases the lock (SYSTem:LOCK:RELease).
11	Not Used	2048	(Reserved for future use)
12	Not Used	4096	(Reserved for future use)
13	Global Error	8192	Set if any remote interface has an error in its error queue; cleared otherwise.
14	Not Used	16384	(Reserved for future use)
15	Not Used	32768	"0" is returned.

Command Summary

[STATus:OPERation:CONDition?](#)

[STATus:OPERation:ENABLE](#)

[STATus:OPERation\[:EVENT\]?](#)

[STATus:PRESet](#)

[STATus:QUEStionable:CONDition?](#)

[STATus:QUEStionable:ENABLE](#)

[STATus:QUEStionable\[:EVENT\]?](#)

STATus:OPERation:CONDition?

Returns the sum of the bits in the condition register for the [Standard Operation Register](#) group. This register is read-only; bits are not cleared when read.

A condition register continuously monitors the state of the instrument. Condition register bits are updated in real time; they are neither latched nor buffered.

Parameter	Typical Return
(none)	+32
Read the condition register (bit 5 is set):	
STAT:OPER:COND?	

- The condition register bits reflect the current condition. If a condition goes away, the corresponding bit is cleared in the condition register.

STATus:OPERation:ENABLE <enable_value>

STATus:OPERation:ENABLE?

Enables bits in the enable register for the [Standard Operation Register](#) group. The selected bits are then reported to the Status Byte. An enable register defines which bits in the event register will be reported to the Status Byte register group. You can write to or read from an enable register.

Parameter	Typical Return
A decimal value that corresponds to the binary-weighted sum of the bits in the register.	+32
Enable bit 5 (decimal value 32) in the enable register:	
STAT:OPER:ENAB 32	

- Use the <enable> parameter to specify which bits will be reported to the Status Byte. The decimal value specified corresponds to the binary-weighted sum of the bits you wish to enable in the register. For example, to enable bit 5 (decimal value = 32) and bit 9 (decimal value = 512), the corresponding decimal value would be 544 (32 + 512).
- A [STATus:PRESet](#) clears all bits in the enable register.
- The <enable> setting is nonvolatile; it does not change after a Factory Reset ([*RST](#)), Instrument Pre-set ([SYSTem:PRESet](#)), Status Preset ([STATus:PRESet](#)) or Clear Status ([*CLS](#)).
- The [*PSC](#) command controls whether the enable register is cleared at power on.

STATus:OPERation[:EVENT]?

Returns the sum of the bits in the event register for the [Standard Operation Register](#) group. An event register is a read-only register that latches events from the condition register. While an event bit is set, subsequent events corresponding to that bit are ignored. The register bits are cleared when you read the register.

Parameter	Typical Return
(none)	+512
Read the event register (bit 9 is set):	
STAT:OPER:EVEN?	

- Once a bit is set, it remains set until cleared by reading the event register or by sending [*CLS](#) (clear status).

STATus:PRESet

Clears [Questionable Data](#) enable register and [Standard Operation](#) enable register.

Parameter	Typical Return
(none)	(none)
Clear enable register bits:	
STAT:PRES	

STATus:QUEStionable:CONDition?

Returns the sum of the bits in the condition register for the [Questionable Data Register](#) group. This register is read-only; bits are not cleared when read.

A condition register continuously monitors the state of the instrument. Condition register bits are updated in real time; they are neither latched nor buffered.

Parameter	Typical Return
(none)	+4096
Read the condition register (bit 12 is set):	
STAT:QUES:COND?	

- The condition register bits reflect the current condition. If a condition goes away, the corresponding bit is cleared in the condition register.

STATus:QUESTIONable:ENABLE <enable_value>

STATus:QUESTIONable:ENABLE?

Enables bits in the enable register for the [Questionable Data Register](#) group. The selected bits are then reported to the Status Byte. An enable register defines which bits in the event register will be reported to the Status Byte register group. You can write to or read from an enable register.

Parameter	Typical Return
A decimal value that corresponds to the binary-weighted sum of the bits in the register.	+512
Enable bit 9 (decimal value 512) in the enable register.	

- Use the <enable> parameter to specify which bits will be reported to the Status Byte. The decimal value specified corresponds to the binary-weighted sum of the bits you wish to enable in the register. For example, to enable bit 0 (decimal value = 1), bit 1 (decimal value = 2) and bit 12 (decimal value = 4096), the corresponding decimal value would be 4099 (1 + 2 + 4096).
- A [STATus:PRESet](#) clears all bits in the enable register.
- The <enable> setting is nonvolatile; it does not change after a Factory Reset ([*RST](#)), Instrument Pre-set ([SYSTem:PRESet](#)), Status Preset ([STATus:PRESet](#)) or Clear Status ([*CLS](#)).
- The [*PSC](#) command controls whether the enable register is cleared at power on.

STATus:QUESTIONable[:EVENT]?

Returns the event register for the [Questionable Data Register](#) group. An event register is a read-only register that latches events from the condition register. While an event bit is set, subsequent events corresponding to that bit are ignored. The register bits are cleared when you read the register.

Parameter	Typical Return
(none)	+1024
Read the event register (bit 10 is set): STAT:QUES?	

- Once a bit is set, it remains set until cleared by reading the event register or by sending [*CLS](#) (clear status).

SYSTEM Subsystem – General Purpose Commands

The SYSTEM subsystem includes general commands (listed below), [license management commands](#), and [remote interface configuration commands](#).

Command Summary

[SYSTEM:ACALibration:DATE?](#)

[SYSTEM:ACALibration:TEMPerature?](#)

[SYSTEM:ACALibration:TIME?](#)

[SYSTEM:BEEPer\[:IMMEDIATE\]](#)

[SYSTEM:BEEPer:STATe](#)

[SYSTEM:CLICk:STATe](#)

[SYSTEM:DATE](#)

[SYSTEM:ERRor\[:NEXT\]?](#)

[SYSTEM:HELP?](#)

[SYSTEM:IDENtify](#)

[SYSTEM:LABel](#)

[SYSTEM:PRESet](#)

[SYSTEM:SECurity:COUNT?](#)

[SYSTEM:SECurity:IMMEDIATE](#)

[SYSTEM:TEMPerature?](#)

[SYSTEM:TIME](#)

[SYSTEM:UPTime?](#)

[SYSTEM:VERSion?](#)

[SYSTEM:WMESsage](#)

SYSTem:ACALibration:DATE?

Returns the date of the last autocalibration in the format *yyyy,mm,dd*.

Parameter	Typical Return
(none)	2014,4,26
Return the autocalibration date: SYST:ACAL:DATE?	

- You can perform this query regardless of whether the instrument is secured.
- The date is based on the instrument's real-time clock. Set the date for the instrument's real-time clock with [SYSTem:DATE](#).
- The real-time clock does not adjust itself for time zone changes or daylight savings time. Be sure to set the date and time when you first receive your instrument.
- This setting is non-volatile; it will not be changed by power cycling or [*RST](#) or [SYSTem:PRESet](#).
- Use [*CAL?](#) to perform autocal.

See Also

[SYSTem:DATE](#)

SYSTem:ACALibration:TEMPerature?

Returns the temperature of the last autocalibration in °C.

Parameter	Typical Return
(none)	+2.42850208E+001
Return the autocalibration temperature: SYST:ACAL:TEMP?	

- You can perform this query regardless of whether the instrument is secured.
- This setting is non-volatile; it will not be changed by power cycling or [*RST](#) or [SYSTem:PRESet](#).
- Use [*CAL?](#) to perform autocal.

SYSTem:ACALibration:TIME?

Returns the time of the last autocalibration in the format *hh,mm,ss.sss*.

Parameter	Typical Return
(none)	20,15,30.000
Return the calibration time: SYST:ACAL:TIME?	

- The date is based on the instrument's real-time clock. Set the date for the instrument's real-time clock with SYSTem:DATE.
- The real-time clock does not adjust itself for time zone changes or daylight savings time. Be sure to set the date and time when you first receive your instrument.
- This parameter is set to its default value after a Factory Reset (***RST**) or Instrument Preset (**SYSTem:PRESet**).
- Use ***CAL?** to perform autocal.

See Also

[SYSTem:TIME](#)

SYSTem:BEEPer[:IMMEDIATE]

Issues a single beep.

Parameter	Typical Return
(none)	(none)
Issue a single beep: SYST:BEEP	

- Programmed beeps may be useful for program development and troubleshooting.
- You can issue a beep with this command regardless of the current beeper state (**SYSTem:BEEPer:STATe**).

SYSTem:BEEPer:STATe {ON|1|OFF|0}

SYSTem:BEEPer:STATe?

Disables or enables the beep heard during continuity, diode, or probe hold measurements, or when an error is generated from the front panel or remote interface.

Parameter	Typical Return
{ON 1 OFF 0}. Default: ON.	0 (OFF) or 1 (ON)
Disable beeper state: SYST:BEEP:STAT OFF	

- Does not affect the front panel key click.
- A beep is always emitted (even with beeper state OFF) when [SYSTem:BEEPer](#) is sent.
- This setting is non-volatile; it is not changed by power cycling, a Factory Reset ([*RST](#)), or an Instrument Preset ([SYSTem:PRESet](#)).

SYSTem:CLICk:STATe {ON|1|OFF|0}

SYSTem:CLICk:STATe?

Disables or enables the click heard when a front panel key or softkey is pressed.

Parameter	Typical Return
{ON 1 OFF 0}. Default: ON.	0 (OFF) or 1 (ON)
Disable keyboard click: SYST:CLIC:STAT OFF	

- Does not affect the beeper for diode and continuity tests, errors and so on.
- This setting is non-volatile; it is not changed by power cycling, a Factory Reset ([*RST](#)), or an Instrument Preset ([SYSTem:PRESet](#)).

SYSTem:DATE <year>, <month>, <day>
SYSTem:DATE?

Sets the date for the instrument's real-time clock. Use [SYSTem:TIME](#) to set the time.

Parameter	Typical Return
<year> 2000 to 2099 <month> 1 to 12 <day> 1 to 31	+2011,+07,+26
Set system date to July 26, 2011: SYST:DATE 2011, 7,26	

- The real-time clock is used for Mass Memory (MMEMory) system file time stamps.
- The real-time clock is battery-backed and retains the date and time when power is off.
- The date and time are not affected by [*RST](#) or [SYSTem:PRESet](#).
- The real-time clock does not adjust itself for time zone changes or daylight savings time. Be sure to set the date and time when you first receive your instrument.

SYSTem:ERRor[:NEXT]?

Reads and clears one error from the error queue. See [SCPI Error Messages](#) for the complete SCPI error message list.

Parameter	Typical Return
(none)	-113,"Undefined header"
Read and clear the first error in the error queue: SYST:ERR?	

- Up to 20 errors can be stored in the instrument's error queue. Each remote interface I/O session (GPIB, USB, VXI-11, Telnet/Sockets) has its own interface-specific error queue. Errors appear in the error queue of the I/O session that caused the error. For example, if an error was generated by a command sent over GPIB, send [SYSTem:ERRor?](#) from GPIB to read the error queue. Errors generated by instrument hardware are broadcast to all I/O sessions.
- Error retrieval is first-in-first-out (FIFO), and errors are cleared as you read them. The instrument beeps each time an error is generated (unless disabled by [SYSTem:BEEPer:STATe OFF](#)).
- If more than 20 errors have occurred, the most recent error stored in the queue is replaced with -350,"Queue overflow". No additional errors are stored until you remove errors from the queue. If no errors have occurred when you read the error queue, the instrument responds with +0,"No error".
- Errors have the following format (the error string may contain up to 255 characters).

<error code>,<error string>

Where:

<error code> = a positive or negative integer

<error string> = a quoted ASCII string up to 255 characters

See Also

[*SRE](#)

SYSTem:HELP?

Returns a complete list of the instrument's SCPI commands.

Parameter	Typical Return
(none)	(see below)
Return the list of SCPI commands:	
SYST:HELP?	

- The query returns Definite Length Block Data, which allows any type of data to be transmitted as a series of 8-bit data bytes. The first line is a pound sign (#) followed by one digit representing the number of digits in the decimal integer to follow. This digit is followed by a decimal integer indicating the number of data bytes to follow, followed by the first New Line. (For example, "#47947" in the first line means that there are 7947 data bytes to follow.) The rest of the block has one command per line, each terminated by a New Line character (ASCII character 10).

The beginning of a returned list is shown below. Note that the actual contents may vary, depending on the firmware revision:

```
#48085
:ABORt/nquery/
:CALibration:ADC?/qonly/
:CALibration:ALL?/qonly/
:CALibration:COUNT?/qonly/
:CALibration:DATA
```

In this list,

- /nquery/ indicates a command with no query.
- /qonly/ indicates a query with no command form.
- All other commands consist of a command and query.
- Syntax for each command is found in the [Command Quick Reference](#).
- The list may include commands or queries not described in this document. These are deprecated commands included for compatibility with older instruments.

SYSTem:IDENtify {DEFault|AT34460A|AT34461A|AT34410A|AT34411A|HP34401A}
SYSTem:IDENtify?

Selects the manufacturer and model number returned by ***IDN?**. The serial number and revision information are unaffected, and this command does not change instrument operation. Use to avoid changing existing test system code where the manufacturer/model number are verified.

Parameter	Typical Return
{DEFault AT34460A AT34461A AT34410A AT34411A HP34401A} (see bullet points below)	DEF (see bullet points below), HP34401A, AT34410A, or AT34411A
Select a *IDN? response compatible with the 34401A:	
SYST:IDEN HP34401A *IDN?	
Typical Response: HEWLETT-PACKARD,34401A,...	

- The allowable parameters for each DMM model are:
 - 34460A - valid parameters: DEFault, AT34460A, HP34401A
 - 34461A - valid parameters: DEFault, AT34461A, HP34401A
 - 34465A - valid parameters: DEFault, AT34410A, AT34411A
 - 34470A - valid parameters: DEFault, AT34410A, AT34411A
- DEFault returns "Keysight Technologies" followed by the actual instrument model number:
 - "Keysight Technologies,34460A, ..."
 - "Keysight Technologies,34461A, ..."
 - "Keysight Technologies,34465A, ..."
 - "Keysight Technologies,34470A, ..."
- If you have an older Agilent 34460A or 34461A and upgrade to the new (Keysight) firmware, your instrument continues to respond with the manufacturer name "Agilent", not "Keysight" until you set the front panel SCPI ID to 34460A or 34461A, send the **SYST:IDEN DEF** command, or reset user preferences. After doing this, the instrument responds with "Keysight" as the manufacturer.
- This setting is non-volatile; it is not changed by power cycling, a Factory Reset (***RST**), or an Instrument Preset (**SYSTem:PRESet**).
- **Important:** In order to update the instrument firmware *from remote*, the model number in the ***IDN?** response must match the actual instrument model number. If you have changed the instrument's ***IDN?** response to another instrument, when attempting to update the firmware from remote, you will see this error: *The instrument is not supported by this firmware file.* To update the firmware, either update using the front panel procedure or, from remote, use **SYSTem:IDENtify** to set the ***IDN?** to match the actual model number, update the firmware, and then use **SYSTem:IDENtify** again to set the ***IDN?** response to the other model number.

SYSTem:LABel "<string>"
SYSTem:LABel?

Places a message in a large font on the bottom half of the instrument's front panel display.

Parameter	Typical Return
A quoted string of up to 40 characters. You can use letters (A-Z), numbers (0-9) and special characters such as @, %, *, and so forth. Default ""	"Battery DCI"
Set the message to be displayed on the screen : SYST:LAB "Battery DCI" To turn off the message, send the following to change the label to a null string. This also removes the label area from the screen : SYST:LAB ""	

- If you enter a string longer than 40 characters, the instrument truncates the string after the first 40 characters.
- The font size changes based on the length of the message and whatever other information is shown on the display.
- The value of this parameter is not affected by [*RST](#) or [SYSTem:PRESet](#).

SYSTem:PRESet

This command is nearly identical to [*RST](#). The difference is that *RST resets the instrument for SCPI operation, and SYSTem:PRESet resets the instrument for front panel operation. As a result, *RST turns the histogram and statistics off, and SYSTem:PRESet turns them on.

SYSTem:SECurity:COUNT?

Returns the instrument's security count.

Parameter	Typical Return
(none)	+22
Return the instrument's security count: SYSTem:SECurity:COUNT?	

- The security count is incremented by 1 every time you perform an action, other than calibration, that requires the instrument to be unsecured. This includes enabling or disabling interfaces, sanitizing memory per the NISPOM standard ([SYSTem:SECurity:IMMEDIATE](#)), updating firmware, changing the security code, or overriding the calibration security.
- The act of securing or unsecuring the instrument does not increment the counter.
- Be sure to read the security count upon receiving your instrument.

See Also

[CALibration:COUNT?](#)

SYSTem:SECurity:IMMEDIATE

(Requires the SEC option.) Sanitizes all user-accessible instrument memory except for the calibration constants and reboots the instrument. This complies with requirements in chapter 8 of the National Industrial Security Program Operating Manual (NISPOM).

Requires the optional security feature. See [Models and Options](#) for details.

CAUTION The **NISPOM Sanitize** softkey and the SYSTem:SECurity:IMMEDIATE command are equivalent. They are for customers, such as military contractors, who must comply with NISPOM.

This feature destroys all user-defined state information, measurement data, and user-defined I/O settings such as the IP address. This feature is not recommended for use in routine applications because of the possibility of unintended data loss.

Parameter	Typical Return
(none)	(none)
Sanitize all user-accessible instrument memory: SYST:SEC:IMM	

- Typically used before removing an instrument from a secure area.
- Initializes all instrument settings to their Factory Reset (***RST**) values. It also destroys all user-defined state and preference information (see [MMEMory Subsystem - STATe and PREFerence Files](#)).
- Increments the [security count](#).

SYSTem:TEMPerature?

Returns the instrument's internal temperature in °C.

Parameter	Typical Return
(none)	+2.85000000E+01
Return the instrument's internal temperature: SYST:TEMP?	

- The value returned is not affected by [UNIT:TEMPerature](#).

SYSTem:TIME <hour>, <minute>, <second>

SYSTem:TIME?

Sets the time for the instrument's real-time clock. Use SYSTem:DATE to set the date.

Parameter	Typical Return
<hour> 0 to 23 <minute> 0 to 59 <second> 0 to 60	20,15,30.000
Set instrument time to 20:15:30 (8:15:30 PM):	
SYST:TIME 20,15,30	

- The real-time clock is used for Mass Memory (MMEMory) system file time stamps.
- The real-time clock is battery-backed and retains the date and time when power is off.
- The date and time are not affected by [*RST](#) or [SYSTem:PRESet](#).
- The real-time clock does not adjust itself for time zone changes or daylight savings time. Be sure to set the date and time when you first receive your instrument.

SYSTem:UPTime?

Returns the amount of time that the instrument has been running since the last power-on.

Parameter	Typical Return
(none)	+8,+2,+13,+50
Return time that the instrument has been running:	
SYST:UPT?	

- Typically used to verify that the instrument is warmed up sufficiently before calibration.
- The numbers returned indicate days, hours, minutes, and seconds, respectively.

SYSTem:VERSion?

Returns the version of SCPI (Standard Commands for Programmable Instruments) that the instrument complies with. There is no front panel equivalent. See [Introduction to the Introduction to the SCPI Language](#) for details.

Parameter	Typical Return
(none)	1994.0
Return the SCPI version:	
SYST:VERS?	

SYSTem:WMESsage "<string>"

SYSTem:WMESsage?

Displays a power-on message.

Parameter	Typical Return
A quoted string of up to 40 characters. You can use letters (A-Z), numbers (0-9) and special characters such as @, %, *, and so forth. Default ""	"RETURN TO JOE AT POST D6"
Display a power-on message: SYST:WMES "RETURN TO JOE AT POST D6"	

- Specifying a null string ("") disables the power-on message.
- This setting is non-volatile; it is not changed by power cycling, a Factory Reset ([*RST](#)), or an Instrument Preset ([SYSTem:PRESet](#)).
- This parameter is set to its default value when the instrument is shipped from the factory and after [SYSTem:SECurity:IMMediate](#).

SYSTem Subsystem - I/O Configuration

The SYSTem subsystem includes [general instrument configuration commands](#), [I/O locking commands](#), [license management commands](#), and remote interface configuration commands (listed below).

Command Summary

[SYSTem:COMMunicate:ENABLE](#)

[SYSTem:COMMunicate:GPIB:ADDRess](#)

[SYSTem:COMMunicate:LAN:CONTRol?](#)

[SYSTem:COMMunicate:LAN:DHCP](#)

[SYSTem:COMMunicate:LAN:DNS\[**{1|2}**\]](#)

[SYSTem:COMMunicate:LAN:DOMain?](#)

[SYSTem:COMMunicate:LAN:GATeway](#)

[SYSTem:COMMunicate:LAN:HOSTname](#)

[SYSTem:COMMunicate:LAN:IPADdress](#)

[SYSTem:COMMunicate:LAN:MAC?](#)

[SYSTem:COMMunicate:LAN:SMASk](#)

[SYSTem:COMMunicate:LAN:TELNet:PRoMpt](#)

[SYSTem:COMMunicate:LAN:TELNet:WMESsage](#)

[SYSTem:COMMunicate:LAN:UPDate](#)

[SYSTem:COMMunicate:LAN:WINS\[**{1|2}**\]](#)

[SYSTem:USB:HOST:ENABLE](#)

SYSTem:COMMunicate:ENABle {ON|1|OFF|0}, <interface>

SYSTem:COMMunicate:ENABle? <interface>

Disables or enables the GPIB, USB, or LAN remote interface. Also disables or enables available remote services such as Sockets, HiSLIP, Telnet, VXI11, and the built-in Web Interface.

NOTE The GPIB interface is an optional feature. See [Models and Options](#) for details.

Parameter	Typical Return
{ON 1 OFF 0}. Default: ON. for all interfaces	0 (OFF) or 1 (ON)
<interface> : {GPIB HISLIP USB LAN SOCKETs TELNet VXI11 WEB USBMtp USBHost}	
Disable the USB interface: SYST:COMM:ENAB OFF,USB	

- After making changes, you must cycle instrument power for the changes to take effect.
- Enabling USBMtp allows you to transfer files, using media transfer protocol (MTP), from the instrument to a PC via the rear-panel USB port. See [Utility Menu - I/O Configuration](#) for more information on MTP.
- The USBHost parameter refers to the instrument's front panel USB port.
- If you disable the LAN interface, none of the associated LAN services will be started when you power on the instrument.
- [SYSTem:SECurity:IMMEDIATE](#) enables all interfaces except USBMtp.
- For HiSLIP, LAN, SOCKETs, TELNet, VXI11, or WEB on the 34460A, you must have option 34460A-LAN or option 3446LANU.
- The interface enable settings are stored in nonvolatile memory. They do not change when power has been off, after a Factory Reset ([*RST](#)) or after an Instrument Preset ([SYSTem:PRESet](#)).

SYSTem:COMMunicate:GPIB:ADDRess <address>

SYSTem:COMMunicate:GPIB:ADDRess?

Assigns instrument's GPIB (IEEE-488) address, which is displayed at power-on. Each device on the GPIB interface must have a unique address.

NOTE The GPIB interface is an optional feature. See [Models and Options](#) for details.

Parameter	Typical Return
0 to 30, default 22	+15
Set GPIB address to 15:	
SYST:COMM:GPIB:ADDR 15	

- Your computer's GPIB interface card has its own address. Avoid using this address for any instrument on the GPIB bus.
- Cycle power for this command to take effect.
- GPIB is enabled or disabled by [SYSTem:COMMunicate:ENABle](#).
- The GPIB interface is an optional feature. See [Models and Options](#) for details.
- This setting is non-volatile; it is not changed by power cycling, a Factory Reset (***RST**), or an Instrument Preset ([SYSTem:PRESet](#)).
- This parameter is set to its default value when the instrument is shipped from the factory and after [SYSTem:SECurity:IMMediate](#).

SYSTem:COMMunicate:LAN:CONTRol?

Reads the initial Control connection port number for Sockets communications. This connection is used to send and receive commands and queries.

Parameter	Typical Return
(none)	5000 (0 if the interface does not support sockets)
Return the Control connection port number: SYST:COMM:LAN:CONT?	

- Use the Control socket connection to send a Device Clear (DCL) to the instrument or to detect pending Service Request (SRQ) events.
- On the 34460A, this requires option 34460A-LAN or option 3446LANU.

SYSTem:COMMunicate:LAN:DHCP {ON|1|OFF|0} SYSTem:COMMunicate:LAN:DHCP?

Disables or enables instrument's use of DHCP. The acronym DHCP stands for Dynamic Host Configuration Protocol, a protocol for assigning dynamic IP addresses to networked devices. With dynamic addressing, a device can have a different IP address every time it connects to the network.

ON: instrument tries to obtain an IP address from a DHCP server. If a DHCP server is found, it assigns a dynamic [IP address](#), [Subnet Mask](#), and [Default Gateway](#) to the instrument.

OFF or DHCP unavailable: instrument uses the static IP address, Subnet Mask, and Default Gateway during power-on.

NOTE If you change this setting, you must send [SYSTem:COMMunicate:LAN:UPDate](#) to activate the new setting.

Parameter	Typical Return
{ON 1 OFF 0}. Default: ON.	0 (OFF) or 1 (ON)
Disable DHCP: SYST:COMM:LAN:DHCP OFF SYST:COMM:LAN:UPDate	

- Most corporate LANs have a DHCP server.
- [SYSTem:SECurity:IMMEDIATE](#) sets this parameter to its default value.
- On the 34460A, this requires option 34460A-LAN or option 3446LANU.
- If a DHCP LAN address is not assigned by a DHCP server, then an Auto-IP address is obtained after approximately 2 minutes. An Auto-IP address has the form 169.254.nnn.nnn.
- This setting is non-volatile; it is not changed by power cycling, a Factory Reset ([*RST](#)), or an Instrument Preset ([SYSTem:PRESet](#)).

SYSTem:COMMunicate:LAN:DNS[*{1|2}*] "<address>"
SYSTem:COMMunicate:LAN:DNS[*{1|2}*]? [*{CURRENT|STATIC}*]

Assigns static IP addresses of Domain Name System (DNS) servers. A primary and a secondary server address may be assigned. If DHCP is available and enabled, DHCP will auto-assign these server addresses. These auto-assigned server addresses take precedence over the static addresses assigned with this command. Contact your LAN administrator for details.

NOTE If you change this setting, you must send [SYSTem:COMMunicate:LAN:UPDate](#) to activate the new setting.

Parameter	Typical Return
Command: " nnn.nnn.nnn.nnn ". Default: "0.0.0.0".	"198.105.232.4"
Query: <i>{CURRENT STATIC}</i> . Default: CURRENT.	
Set a static primary DNS address: SYST:COMM:LAN:DNS "198.105.232.4" SYST:COMM:LAN:UPD	

- **CURRENT**: returns address currently being used by the instrument.
- **STATIC**: returns static address from non-volatile memory. This address is used if DHCP is disabled or unavailable.
- [SYSTem:SECurity:IMMEDIATE](#) sets this parameter to its default value.
- On the 34460A, this requires option 34460A-LAN or option 3446LANU.
- The assigned DNS server addresses are used if DHCP is disabled or unavailable. Otherwise, the DNS server addresses are auto-assigned by DHCP.
- The DNS server addresses are stored in nonvolatile memory. They do not change when power has been off, after a Factory Reset ([*RST](#)) or after an Instrument Preset ([SYSTem:PRESet](#)).

SYSTem:COMMunicate:LAN:DOMain?

Returns the domain name assigned to the instrument.

Parameter	Typical Return
(none)	"example.com"
Return the domain name being used by the instrument: SYST:COMM:LAN:DOM?	

- If Dynamic Domain Name System (DNS) is available on your network and your instrument uses [DHCP](#), the domain name is assigned by the Dynamic DNS service at power-on.
- A null string ("") indicates that no domain name is assigned.
- On the 34460A, this requires option 34460A-LAN or option 3446LANU.

SYSTem:COMMunicate:LAN:GATeway "<address>"
SYSTem:COMMunicate:LAN:GATeway? [{CURRENT|STATIC}]

Assigns a default gateway for the instrument. The specified IP Address sets the default gateway, which allows the instrument to communicate with systems that are not on the local subnet. Thus, this is the default gateway where packets are sent that are destined for a device not on the local subnet, as determined by the [Subnet Mask](#) setting. Contact your LAN administrator for details.

NOTE If you change this setting, you must send [SYSTem:COMMunicate:LAN:UPDate](#) to activate the new setting.

Parameter	Typical Return
Command: " nnn.nnn.nnn.nnn ". Default: "0.0.0.0".	"198.105.232.1"
Query: {CURRENT STATIC}. Default: CURRENT.	
Set default gateway address:	
SYST:COMM:LAN:GATEWAY "198.105.232.1"	
SYST:COMM:LAN:UPD	

- **CURRENT**: returns address currently being used by the instrument.
- **STATIC**: returns static address from non-volatile memory. This address is used if DHCP is disabled or unavailable.
- [SYSTem:SECurity:IMMEDIATE](#) sets this parameter to its default value.
- On the 34460A, this requires option 34460A-LAN or option 3446LANU.
- If DHCP is enabled ([SYSTem:COMMunicate:LAN:DHCP ON](#)), the specified default gateway is not used. However, if the DHCP server fails to assign a valid [IP address](#), the currently configured default gateway is used.
- This setting is non-volatile; it is not changed by power cycling, a Factory Reset ([*RST](#)), or an Instrument Preset ([SYSTem:PRESet](#)).

SYSTem:COMMunicate:LAN:HOSTname "<name>"
SYSTem:COMMunicate:LAN:HOSTname? [{CURRent|STATic}]

Assigns a hostname to the instrument. A hostname is the host portion of the domain name, which is translated into an IP address. If Dynamic Domain Name System (Dynamic DNS) is available on your network and your instrument uses DHCP, the hostname is registered with the Dynamic DNS service at power-on. If DHCP is enabled (SYSTem:COMMunicate:LAN:DHCP ON), the DHCP server can change the specified hostname.

NOTE If you change this setting, you must send [SYSTem:COMMunicate:LAN:UPDate](#) to activate the new setting.

Parameter	Typical Return
String of up to 15 characters. Must start with letter (A-Z) May contain letters, numbers (0-9), or dashes ("-") Default: "K-<instrument model number>-nnnnn", where nnnnn is the last five digits of the instrument's serial number.	"LAB1-34461A"
Define a hostname: SYST:COMM:LAN:HOST "LAB1-DMM" SYST:COMM:LAN:UPD	

- If no hostname exists, a null string ("") is returned.
- On the 34460A, this requires option 34460A-LAN or option 3446LANU.
- For the query form, specify "CURRent" (default) to read the value currently being used by the instrument. Specify "STATic" to read the host name currently stored in nonvolatile memory within the instrument (may not be the actual name used by the instrument if DHCP is enabled).
- This setting is non-volatile; it is not changed by power cycling, a Factory Reset ([*RST](#)), or an Instrument Preset ([SYSTem:PRESet](#)).
- This parameter is set to its default value when the instrument is shipped from the factory and after [SYSTem:SECurity:IMMediate](#).

SYSTem:COMMunicate:LAN:IPADdress "<address>"

SYSTem:COMMunicate:LAN:IPADdress? [{CURRENT|STATIC}]

Assigns a static Internet Protocol (IP) address for the instrument. If DHCP is enabled (SYSTem:COMMunicate:LAN:DHCP ON), the specified static IP address is not used. Contact your LAN administrator for details.

NOTE If you change this setting, you must send [SYSTem:COMMunicate:LAN:UPDate](#) to activate the new setting.

Parameter	Typical Return
Command: " nnn.nnn.nnn.nnn "	"169.254.149.35"
Query: {CURRENT STATIC}. Default: CURRENT.	
Set a static IP address:	
SYST:COMM:LAN:IPAD "169.254.149.35"	
SYST:COMM:LAN:UPD	

- [SYSTem:SECurity:IMMEDIATE](#) sets this parameter to its default value.
- On the 34460A, this requires option 34460A-LAN or option 3446LANU.
- For the query form, specify "CURRENT" (default) to read the value currently being used by the instrument. Specify "STATIC" to read the value currently stored in nonvolatile memory within the instrument (may not be the actual address used by the instrument if DHCP is enabled).
- This setting is non-volatile; it is not changed by power cycling, a Factory Reset ([*RST](#)), or an Instrument Preset ([SYSTem:PRESet](#)).
- This parameter is set to its default value when the instrument is shipped from the factory and after [SYSTem:SECurity:IMMEDIATE](#).

SYSTem:COMMunicate:LAN:MAC?

Returns the instrument's Media Access Control (MAC) address as an ASCII string of 12 hexadecimal characters (0-9 and A-F) enclosed in quotation marks.

NOTE Your LAN administrator may need the MAC address to assign a static IP address for this device.

Parameter	Typical Return
(none)	"0030D3001041"
Return the MAC address:	
SYST:COMM:LAN:MAC?	

- On the 34460A, this requires option 34460A-LAN or option 3446LANU.
- The MAC address is also known as the link-layer address, the Ethernet (station) address, LANIC ID or Hardware Address. This is an unchangeable 48-bit address assigned by the manufacturer to each unique Internet device.

SYSTem:COMMunicate:LAN:SMASk "<mask>"
SYSTem:COMMunicate:LAN:SMASk? [{CURRENT|STATic}]

Assigns a subnet mask for the instrument to use in determining whether a client IP address is on the same local subnet. When a client [IP address](#) is on a different subnet, all packets must be sent to the [Default Gateway](#). Contact your LAN administrator for details.

NOTE If you change this setting, you must send [SYSTem:COMMunicate:LAN:UPDate](#) to activate the new setting.

Parameter	Typical Return
Command: " nnn.nnn.nnn.nnn ". Default: "255.255.0.0".	"255.255.255.0"
Query: {CURRENT STATic}. Default: CURRENT.	
Set the subnet mask:	
SYST:COMM:LAN:SMAS "255.255.255.0"	
SYST:COMM:LAN:UPD	

- On the 34460A, this requires option 34460A-LAN or option 3446LANU.
- If DHCP is enabled ([SYSTem:COMMunicate:LAN:DHCP ON](#)), the specified subnet mask is not used. However, if the DHCP server fails to assign a valid IP address, the instrument uses the Auto-IP subnet mask.
- A value of "0.0.0.0" or "255.255.255.255" indicates that subnetting is not being used.
- [SYSTem:SECurity:IMMEDIATE](#) sets this parameter to its default value.
- **CURRENT**: returns address currently being used by the instrument.
- **STATIC**: returns static address from non-volatile memory. This address is used if DHCP is disabled or unavailable.
- This setting is non-volatile; it is not changed by power cycling, a Factory Reset ([*RST](#)), or an Instrument Preset ([SYSTem:PRESet](#)).

SYSTem:COMMunicate:LAN:TELNet:PROMpt "<string>"
SYSTem:COMMunicate:LAN:TELNet:PROMpt?

Sets the command prompt seen when communicating with the instrument via Telnet.

Parameter	Typical Return
String of up to 15 characters Default is Instrument Model Number: 34460A> , 34461A> , 34465A> , or 34470A>	"Command>"
Set the command prompt: SYST:COMM:LAN:TELN:PROM "Command>"	

- On the 34460A, this requires option 34460A-LAN or option 3446LANU.
- The instrument uses LAN port 5024 for SCPI Telnet sessions and port 5025 for SCPI Socket sessions.
- Telnet sessions are typically started from a host computer shell:

```
telnet <IP_address> <port>
```

For example:

```
telnet 169.254.4.10 5024
```

To exit a Telnet session, press <Ctrl-D>.

- This setting is non-volatile; it is not changed by power cycling, a Factory Reset (***RST**), or an Instrument Preset (**SYSTem:PRESet**).
- **SYSTem:SECurity:IMMEDIATE** sets this parameter to its default value.

SYSTem:COMMunicate:LAN:TELNet:WMESsage "<string>"
SYSTem:COMMunicate:LAN:TELNet:WMESsage?

Sets welcome message seen when communicating with instrument via Telnet.

Parameter	Typical Return
Quoted string of up to 63 characters. Default: "Welcome to Keysight's <instrument model number> Digital Multimeter"	"Welcome to the Telnet Session"
Define a welcome message: SYST:COMM:LAN:TELN:WMES "Welcome to the Telnet Session"	

- On the 34460A, this requires option 34460A-LAN or option 3446LANU.
- The instrument uses LAN port 5024 for SCPI Telnet sessions and port 5025 for SCPI Socket sessions.
- This setting is non-volatile; it is not changed by power cycling, a Factory Reset (***RST**), or an Instrument Preset (**SYSTem:PRESet**).
- **SYSTem:SECurity:IMMEDIATE** sets this parameter to its default value.

SYSTem:COMMunicate:LAN:UPDate

Stores any changes made to the LAN settings into non-volatile memory and restarts the LAN driver with the updated settings.

Parameter	Typical Return
(none)	(none)
(see below)	

- On the 34460A, this requires option 34460A-LAN or option 3446LANU.
- Must be sent after changing the settings for DHCP, DNS, gateway, hostname, IP address, subnet mask, or WINS.
- Make all changes to the LAN settings before sending this command.

Example

The following example configures the instrument to use statically assigned LAN settings.

```
SYST:COMM:LAN:DHCP OFF
SYST:COMM:LAN:DNS "198.105.232.4"
SYST:COMM:LAN:DNS2 "198.105.232.5"
SYST:COMM:LAN:GAT "198.105.232.1"
SYST:COMM:LAN:HOST "LAB1-DMM"
SYST:COMM:LAN:IPAD "198.105.232.101"
SYST:COMM:LAN:SMAS "255.255.255.0"
SYST:COMM:LAN:WINS "198.105.232.4"
SYST:COMM:LAN:WINS "198.105.232.5"
SYST:COMM:LAN:UPD
```

The following example configures the instrument back to use DHCP.

```
SYST:COMM:LAN:DHCP ON
SYST:COMM:LAN:UPD
```

SYSTem:COMMunicate:LAN:WINS[*{1|2}*] "<address>"
SYSTem:COMMunicate:LAN:WINS[*{1|2}*]? [*{CURRENT|STATIC}*]

Assigns the static IP addresses of the Windows Internet Name System (WINS) servers. A primary and a secondary server address may be assigned. If DHCP is available and enabled, DHCP will auto-assign these server addresses. These auto-assigned server addresses take precedence over the static addresses assigned with this command. Contact your LAN administrator for details.

NOTE

If you change this setting, you must send [SYSTem:COMMunicate:LAN:UPDate](#) to activate the new setting.

Parameter	Typical Return
Command: " nnn.nnn.nnn.nnn ". Default: "0.0.0.0".	"198.105.232.4"
Query: <i>{CURRENT STATIC}</i> . Default: <i>CURRENT</i> .	
Set a static primary WINS address:	
SYST:COMM:LAN:WINS "198.105.232.4"	
SYST:COMM:LAN:UPD	

- On the 34460A, this requires option 34460A-LAN or option 3446LANU.
- The WINS addresses are stored in nonvolatile memory. They do not change when power has been off, after a Factory Reset ([*RST](#)) or after an Instrument Preset ([SYSTem:PRESet](#)).
- [SYSTem:SECurity:IMMEDIATE](#) sets this parameter to its default value.
- **CURRENT**: returns address currently being used by the instrument.
- **STATIC**: returns static address from non-volatile memory. This address is used if DHCP is disabled or unavailable.

SYSTem:USB:HOST:ENABLE {ON|1|OFF|0}
SYSTem:USB:HOST:ENABLE?

Disables or enables the front panel USB host port. Calibration security must be unsecured ([CALibration:SECure:STATe <code>,OFF](#)) before sending this command.

Parameter	Typical Return
{ON 1 OFF 0}. Default: OFF.	0 (OFF) or 1 (ON)
Disable the USB host port: CAL:SEC:STAT OFF,MY_CAL_CODE SYST:USB:HOST:ENAB OFF CAL:SEC:STAT ON	

- This feature requires the SEC licensed option. This option can be ordered as factory option or as customer-installable option. See [Models and Options](#) for details. Without this option, the front panel USB interface is always enabled.
- If the front panel USB host port is disabled, it cannot be used to store or load measurements, state files, preferences or other files or to perform firmware update.
- This setting is non-volatile; it is not changed by power cycling, a Factory Reset ([*RST](#)), or an Instrument Preset ([SYSTem:PRESet](#)).

SYSTEM Subsystem LOCK Commands

This subsystem locks and releases instrument I/O interfaces, as shown in the following example:

Initial State = unlocked, Count = 0

```
(FROM USB) SYST:LOCK:REQ? returns "1" (request successful)
```

State = locked, Count = 1

```
(FROM GPIB) SYST:LOCK:REQ? returns "0" because USB has lock
```

State = locked, Count = 1

```
(FROM USB) SYST:LOCK:REQ? returns "1" (request successful)
```

State = locked, Count = 2

```
(FROM USB) SYST:LOCK:REL
```

State = locked, Count = 1

```
(FROM USB) SYST:LOCK:REL
```

State = unlocked, Count = 0

For each successful lock request, a lock release is required. Two requests require two releases.

Command Summary

[SYSTEM:LOCK:NAME?](#)

[SYSTEM:LOCK:OWNER?](#)

[SYSTEM:LOCK:RELEASE](#)

[SYSTEM:LOCK:REQUEST?](#)

SYSTem:LOCK:NAME?

Returns the I/O interface in use by the querying computer.

Parameter	Typical Return
(none)	"LAN169.254.149.35"
See Interface Locking Example	

- After determining the interface that you are using, use [SYSTem:LOCK:OWNer?](#) to determine which interface, if any, has the lock.
- Returns "USB", "VXI11", "GPIB", "LAN<IP Address>", or "WEB<IP Address>" indicating the I/O interface being used by the querying computer.

SYSTem:LOCK:OWNer?

Returns the I/O interface that currently has a lock.

Parameter	Typical Return
(none)	"LAN169.254.149.35"
See Interface Locking Example	

- When a lock is active, Bit 10 in the Standard Operation Register will be set ([STATus:OPERa-tion:CONDition?](#)). When the lock is released on all I/O interfaces, this bit will be cleared.
- Returns "USB", "VXI11", "GPIB", "LAN<IP Address>", or "WEB<IP Address>" indicating the I/O interface that currently has a lock. If no interface has a lock, "NONE" is returned.

SYSTem:LOCK:RELease

Decrements the lock count by 1 and may release the I/O interface from which the command is executed.

Parameter	Typical Return
(none)	(none)
See Interface Locking Example	

- When a lock is active, Bit 10 in the Standard Operation Register will be set ([STATus:OPERa-tion:CONDition?](#)). When the lock is released on all I/O interfaces, this bit will be cleared.

SYSTem:LOCK:REQuest?

Requests a lock of the current I/O interface. This allows you to lock the instrument's configuration or cooperatively share the instrument with other computers.

Parameter	Typical Return
(none)	+0 (denied) or +1 (granted)
See Interface Locking Example	

- Lock requests can be nested; each request increases lock count by 1. For every request, you need a release ([SYSTem:LOCK:RELease](#)) from the same I/O interface.
- Locks are handled at the I/O interface level (USB, LAN, etc.) and you are responsible for all coordination between threads and/or programs on that interface.
- When a request is granted, only I/O sessions from the present interface can change the instrument state. You can only query the instrument state from other I/O interfaces.
- LAN sessions locks are automatically released when a LAN disconnect is detected.
- Granting a lock sets Bit 10 in the Standard Operation Register ([STATus:OPERation:CONDition?](#)). In addition, the entire instrument front panel, including the **Local** key, is locked out while a lock is in place ("Front panel locked." is displayed).

SYSTEM Subsystem LICense Commands

This subsystem manages licensed instrument options.

Command Summary

[SYSTEM:LICense:CATalog?](#)

[SYSTEM:LICense:DELeTe](#)

[SYSTEM:LICense:DELeTe:ALL](#)

[SYSTEM:LICense:DESCRiption?](#)

[SYSTEM:LICense:ERRor?](#)

[SYSTEM:LICense:ERRor:COUNt?](#)

[SYSTEM:LICense:INSTall](#)

SYSTEM:LICense:CATalog?

Returns a comma separated list of installed, [licensed options](#). Only those installed options that require a license are returned. If no licensed options are found, the query returns "".

Parameter	Typical Return
(none)	"LAN","SEC"
Return currently licensed options:	
SYST:LIC:CAT?	

- This query returns a string with the following format:

34460A: "GPB","LAN","SEC"

34461A: "GPB","SEC"

34465A/70A: "GPB","SEC","DIG","MEM"

- Options vary by model, as [shown here](#).

SYSTem:LICense:DELeTe "<option_name>"

Deletes a license and disables the associated functionality.

NOTE If the security option is installed, you must unsecure the instrument with the security code to execute this command.

Parameter	Typical Return
"LAN" or "SEC" (34460A) "SEC" (34461A)	(none)
"DIG", "MEM", or "SEC" (34465A/70A)	
Delete LAN license: SYST:LIC:DEL "LAN"	

- Valid option names are double quoted strings representing the installed [licensed options](#). Installed options can be easily identified using [SYSTem:LICense:CATalog?](#).
- Executing this command sets the instrument to the [factory default state](#).

SYSTem:LICense:DELeTe:ALL

Deletes all licenses and disables the associated functionality.

NOTE If the security option is installed, you must unsecure the instrument with the security code to execute this command.

Parameter	Typical Return
(none)	(none)
Delete all licenses: SYST:LIC:DEL:ALL	

- Executing this command sets the instrument to the [factory default state](#).

SYSTem:LICense:DESCRiption? "<option_name>"

Returns a description of the specified option, regardless of whether it is currently licensed.

Parameter	Typical Return
"LAN" or "SEC" (34460A) "SEC" (34461A)	"Enable instrument security"
"DIG", "MEM", or "SEC" (34465A/70A)	
Return description for option 34460A-LAN or option 3446LANU: SYST:LIC:DESC? "LAN"	

- Valid option names are double quoted strings representing the installed [licensed options](#). Installed options can be easily identified using [SYSTem:LICense:CATalog?](#).

SYSTem:LICense:ERRor?

Returns a string of all the errors produced by [SYSTem:LICense:INSTall](#).

Parameter	Typical Return
(none)	#279File: MyFile.lic<CR><LF>[Ignored - The license file is not formatted correctly.]<CR><LF>
Return the license installation error string:	
SYST:LIC:ERR?	

- The string can be up to 2096 characters.
- Returns a definite-length block containing multi-line ASCII text, including carriage returns and line feeds.

SYSTem:LICense:ERRor:COUnT?

Returns the number of license errors generated by [SYSTem:LICense:INSTall](#).

Parameter	Typical Return
(none)	+0
Return number of license errors:	
SYST:LIC:ERR:COUN?	

SYSTem:LIcense:INSTall [{<folder>|<file>}]

SYSTem:LIcense:INSTall? "<option_name>"

Installs all licenses from a specified file or from all license files in the specified folder.

NOTE If the security option is installed, you must unsecure the instrument with the security code to execute this command.

Parameter	Typical Return
<folder> may be any valid folder name. Default: root directory of a front panel USB storage device. <file> may be any valid license file name "LAN" or "SEC" (34460A) "SEC" (34461A) "DIG", "MEM", or "SEC" (34465A/70A)	0 (license not installed) or 1 (license installed)
Install licenses from license files in the \Licenses folder on a front panel USB storage device: SYST:LIc:INST "USB:\Licenses" Install licenses from the file "MyLicenses.lic" in the \Licenses folder on a front panel USB storage device: SYST:LIc:INST "USB:\Licenses\MyLicenses.lic" Return the status of the license "LAN": SYST:LIc:INST? "LAN" Typical Response: 0	

- License files must have a ".lic" file extension.
- The format for <file> is "[<drive>:<path>]<file_name>", where <drive> can be INTernal or USB, and <path> must be an absolute folder path.
 - INTernal specifies the internal flash file system. USB specifies a front panel USB storage device.
 - If <drive>:<path> is omitted, the folder specified by [MMEMory:CDIRectory](#) is used.
 - Absolute paths begin with "\" or "/" and start at the root folder of <drive>.
 - Folder and file names cannot contain the following characters: \ / : * ? " < > |
 - The combination of folder and file name cannot exceed 240 characters.
 - The specified folder must exist and cannot be marked as hidden or system.
- The format for <folder> is "[[<drive>:]<path>]", where <drive> can be INTernal or USB, and <path> is a folder path.
 - INTernal specifies the internal flash file system. USB specifies a front panel USB storage device.
 - If <drive> is specified, <path> is interpreted as an absolute folder path. Absolute paths begin with "\" or "/" and start at the root folder of <drive>.
 - If <drive> is omitted, <path> is relative to the folder specified by [MMEMory:CDIRectory](#). Relative paths must NOT begin with \ or /.

SCPI Programming Reference

- The *<folder>* parameter cannot exceed 240 characters.
- The specified folder must exist and cannot be marked as hidden or system.

TRIGger Subsystem

The TRIGger subsystem configures the triggering that controls measurement acquisition.

NOTE

Recommendation: All triggered measurements should be made using an appropriate fixed manual range. That is, turn autorange off ([SENSe:]<function>:RANGe:AUTO OFF) or set a fixed range using the [SENSe:]<function>:RANGe, [CONFigure](#), or [MEASure](#) command.

Command Summary

[TRIGger:COUNt](#)

[TRIGger:DELay](#)

[TRIGger:DELay:AUTO](#)

[TRIGger:LEVel](#)

[TRIGger:SLOPe](#)

[TRIGger:SOURce](#)

TRIGger:COUNT {<count>|MIN|MAX|DEF|INFinity}

TRIGger:COUNT? [{MIN|MAX|DEF}]

Selects the number of triggers that are accepted by the instrument before returning to the "idle" trigger state.

Parameter	Typical Return
1 to 1,000,000 (1x10 ⁶) or continuous (INFinity). Default: 1. (34460A/61A) 1 to 1,000,000,000 (1x10 ⁹) or continuous (INFinity). Default: 1. (34465A/70A)	+1.00000000E+00 For a continuous trigger (INFinity), the query returns "9.9E37".
Return ten sets of five DC voltage measurements, using a positive-going external trigger to start each measurement set: CONF:VOLT:DC SAMP:COUN 5 TRIG:COUN 10 TRIG:SOUR EXT;SLOP POS READ? Typical Response: +1.00520000E+01, ... (50 measurements)	

- You can use the specified trigger count in conjunction with a sample count ([SAMPLE:COUNT](#)), which sets the number of samples to be made per trigger. In this case, the number of measurements returned is the sample count multiplied by the trigger count.
- You can store up to 1,000 measurements in the reading memory of the 34460A, 10,000 measurements on the 34461A, 50,000 measurements on the 34465A/70A (*without* the MEM option), or 2,000,000 measurements on the 34465A/70A (*with* the MEM option). If reading memory overflows, new measurements overwrite the oldest measurements stored; the most recent measurements are always preserved. No error is generated, but the Reading Mem Ovfl bit (bit 14) is set in the Questionable Data Register's condition register (see [Status System Introduction](#)).
- A variable trigger count is not available from the front panel. If you set the trigger count and then go to local (front panel), the instrument ignores the trigger count setting; however, when you return to remote, the trigger count returns to the previous value you selected.
- This parameter is set to its default value after a Factory Reset ([*RST](#)) or Instrument Preset ([SYSTEM:PRESet](#)).

TRIGger:DElay {<seconds>|MIN|MAX|DEF}
TRIGger:DElay? [{MIN|MAX|DEF}]

Sets the delay between the trigger signal and the first measurement. This may be useful in applications where you want to allow the input to settle before taking a measurement or for pacing a burst of measurements.

Selecting a specific trigger delay disables the automatic trigger delay ([TRIGger:DElay:AUTO OFF](#)).

NOTE For AC measurements (voltage or current), there is a relationship between the bandwidth setting ([\[SENSe:\]VOLTage:AC:BANDwidth](#) or [\[SENSe:\]CURRent:AC:BANDwidth](#)) and the default trigger delay setting. This delay ensures that there is sufficient settling time for the AC measurement. See [Automatic Trigger Delays](#) for further information.

Parameter	Typical Return
0 to ~3600 seconds (~1 μs steps). Default: 1 s. Step size for DC measurements is approximately 1 μs. Step size depends on AC bandwidth for AC measurements.	+2.00000806E+00
Return five DC voltage measurements. There is a 2 second delay before each measurement. CONF:VOLT:DC 10 SAMP:COUN 5 TRIG:DEL 2 READ? Typical Response: +4.27230000E+00,+4.27150000E+00,+4.27190000E+00,+4.27170000E+00,+4.27200000E+00	

- Due to internal quantization, the actual delay that you set may be slightly different than your specified value. The increment is approximately 1 μs.
- By default, [TRIGger:DElay:AUTO](#) is ON. The instrument automatically determines the delay based on function, range and integration time (see [Automatic Trigger Delays](#)). However, you may need to set a delay longer than the automatic delay for long cables, high capacitance or high impedance signals.
- If you specify a trigger delay with this command, that delay is used for *all* functions (except [CONTInuity](#) and [DIODE](#)) and ranges. The CONTInuity and DIODE tests ignore the trigger delay setting.
- If you have configured the instrument for more than one measurement per trigger ([SAMPle:COUNT](#) >1), the delay is inserted after the trigger and between consecutive measurements.
- The instrument selects automatic trigger delay after a Factory Reset ([*RST](#)) or an Instrument Preset ([SYSTem:PRESet](#)).

TRIGger:DElay:AUTO {ON|1|OFF|0}

TRIGger:DElay:AUTO?

Disables or enables automatic trigger delay. If enabled, the instrument determines the delay based on function, range, and integration time or bandwidth.

Parameter	Typical Return
{ON 1 OFF 0}. Default: ON.	0 (OFF) or 1 (ON)
Return 5 DC voltage measurements, with an automatic delay between each measurement.	
CONF:VOLT:DC 10 SAMP:COUN 5 TRIG:DEL 2 READ?	
Typical Response: +4.27230000E+00,+4.27150000E+00,+4.27190000E+00,+4.27170000E+00,+4.27200000E+00	

- Selecting a specific trigger delay using [TRIGger:DElay](#) disables the automatic trigger delay.
- This parameter is set to its default value after a Factory Reset ([*RST](#)) or Instrument Preset ([SYSTem:PRESet](#)).

TRIGger:LEVel {<level>|MIN|MAX|DEF}

TRIGger:LEVel? [{MIN|MAX|DEF}]

Sets the level on which a trigger occurs when level triggering is enabled ([TRIGger:SOURce](#) set to INTernal).

NOTE

It is recommended that all triggered measurements be made using an appropriate fixed manual range. That is, turn autorange off ([SENSe:<function>:RANGe:AUTO OFF](#)), or set a fixed range using the [SENSe:<function>:RANGe](#), [CONFigure](#), or [MEASure](#) command.

Parameter	Typical Return
<level> (see bullet points below). Default: 0.	+2.00000000E+01
Configures dc voltage measurements, 1 V range, 0.1 mV resolution. Select internal trigger source. Set the trigger level to 0.75 volts, positive slope. INIT puts the instrument in the "wait for trigger" mode.	
CONF:VOLT:DC 1,0.0001 TRIG:SOUR INT TRIG:LEV 0.75 TRIG:SLOP POS INIT	

- Applies only to the 34465A and 34470A, and requires the DIG option.
- Supported only for ac and dc voltage, ac and dc current, frequency, period, 2-wire resistance, 4-wire resistance, RTD and thermistor temperature measurements. Resistance and temperature measurements must have offset compensation and low power disabled.
- To use the trigger level you must select INTernal as the trigger source with the [TRIGger:SOURce](#) command.

- If you are using a wide aperture (NPLC or aperture mode) and the signal level varies significantly within the aperture, you may get an unexpected variation in the magnitude of the triggered measurement from the specified trigger level.
- This parameter is set to its default value after a Factory Reset (***RST**) or Instrument Preset (**SYSTem:PRESet**).
- Specify *<level>* in the fundamental units for the function (volts, ohms, amps, hertz, or seconds). The table below shows the allowable values for *<level>* for each measurement function, range, and input terminals (for DCI and ACI).

Measurement Function	Range/Input Terminals	<level> Parameter Value
DCV	100 mV to 100 V ranges, fixed range	±120% of range
	1000 V range, fixed range	±1000 V
	Autorange	±1000 V
DCI	3 A terminals, fixed range	±120% of range
	3 A terminals, autorange	±3.6 A
	10 A terminals	±12 A
RESistance/FRESistance	All ranges, fixed range	0 to +120% of range
	Autorange	0 to +1.2 GΩ
ACV	100 mV to 100 V ranges, fixed range	0 to +120% of range
	750 V range, fixed range	0 to +1000 V
	Autorange	0 to +1000 V
ACI	3 A terminals, fixed range	0 to +120% of range
	3 A terminals, autorange	0 to +3.6 A
	10 A terminals	0 to +12 A
FREQuency	*N/A	3 Hz to 300 kHz
PERiod	*N/A	3.33333333 μs to 0.333333333 s

*N/A = Not Applicable.

See Also

[TRIGger:DELay](#)

[TRIGger:SOURce](#)

TRIGger:SLOPe {POSitive|NEGative}
TRIGger:SLOPe?

Selects whether the instrument uses the rising edge (POS) or the falling edge (NEG) of the trigger signal on the rear-panel *Ext Trig* BNC connector when external triggering is selected; or the rising or falling edge of the input signal when level triggering is selected (level triggering applies only to the 34465A and 34470A).

Parameter	Typical Return
{POSitive NEGative}. Default: NEG	POS or NEG
Return ten sets of five DC voltage measurements, using a positive-going external trigger to start each measurement set: CONF:VOLT:DC SAMP:COUN 5 TRIG:COUN 10 TRIG:SOUR EXT;SLOP POS READ? Typical Response: +1.00520000E+01, ... (50 measurements)	

- On the 34460A, this requires option 34460A-LAN or option 3446LANU.
- This parameter is set to its default value after a Factory Reset (***RST**) or Instrument Preset (**SYSTem:PRESet**).

TRIGger:SOURce {IMMediate|EXTernal|BUS|INTernal}
TRIGger:SOURce?

Selects the trigger source for measurements.

NOTE It is recommended that all triggered measurements be made using an appropriate fixed manual range. That is, turn autorange off ([SENSe:<function>:RANGe:AUTO OFF](#)), or set a fixed range using the [SENSe:<function>:RANGe](#), [CONFigure](#), or [MEASure](#) command.

Source	Description
IMMediate	The trigger signal is always present. When you place the instrument in the "wait-for-trigger" state, the trigger is issued immediately.
BUS	The instrument is triggered by *TRG over the remote interface once the DMM is in the "wait-for-trigger" state.
EXTernal	The instrument accepts hardware triggers applied to the rear-panel Ext Trig input and takes the specified number of measurements (SAMPle:COUNT), each time a TTL pulse specified by OUTPut:TRIGger:SLOPe is received. If the instrument receives an external trigger before it is ready, it buffers one trigger.
INTernal	The INTernal source is available for the 34465A and 34470A with the DIG option only, and provides level triggering capability. To trigger on a level on the input signal, select INTernal for the source, and set the level and slope with the TRIGger:LEVel and TRIGger:SLOPe commands.

Parameter	Typical Return
{IMMediate EXTernal BUS INTernal}. Default: IMMEDIATE.	IMM, EXT, or BUS
Return ten sets of five DC voltage measurements, using a positive-going external trigger to start each measurement set: CONF:VOLT:DC SAMP:COUN 5 TRIG:COUN 10 TRIG:SOUR EXT;SLOP POS READ? Typical Response: +1.00520000E+01, ... (50 measurements)	

- On the 34460A, EXTernal requires option 34460-LAN or option 3446LANU.
- After selecting the trigger source, you must place the instrument in the "wait-for-trigger" state by sending [INITiate](#) or [READ?](#). A trigger is not accepted from the selected trigger source until the instrument is in the "wait-for-trigger" state.
- This parameter is set to its default value after a Factory Reset ([*RST](#)) or Instrument Preset ([SYSTem:PRESet](#)).
- Recommendation: All triggered measurements should be made using an appropriate fixed manual range. That is, turn autorange off ([\[SENSe:\]<function>:RANGe:AUTO OFF](#)) or set a fixed range using the [\[SENSe:\]<function>:RANGe](#), [CONFigure](#), or [MEASure](#) command.
- This parameter is set to its default value after a Factory Reset ([*RST](#)) or Instrument Preset ([SYSTem:PRESet](#)).

Command Quick Reference

Be sure to read [language syntax conventions](#). Commands or parameters shown in **blue** apply only to the 34465A/70A, all other commands/parameters apply to all Truevolt DMMs.

Configuration Commands

CONFigure?

CONFigure:CAPacitance [{<range>|AUTO|MIN|MAX|DEF} [, {<resolution>|MIN|MAX|DEF}]]

CONFigure:CONTinuity

CONFigure:CURRent:{AC|DC} [{<range>|AUTO|MIN|MAX|DEF} [, {<resolution>|MIN|MAX|DEF}]]

CONFigure:DIODE

CONFigure:{FREQuency|PERiod} [{<range>|MIN|MAX|DEF} [, {<resolution>|MIN|MAX|DEF}]]

CONFigure:{RESistance|FRESistance} [{<range>|AUTO|MIN|MAX|DEF} [, {<resolution>|MIN|MAX|DEF}]]

CONFigure:TEMPerature [{FRTD|RTD|FTHermistor|THERmistor|TCouple|DEFault} [, {<type>|DEFault} [, 1 , {<resolution>|MIN|MAX|DEF}]]]]

CONFigure[:VOLTage]:{AC|DC} [{<range>|AUTO|MIN|MAX|DEF} [, {<resolution>|MIN|MAX|DEF}]]

CONFigure[:VOLTage][:DC]:RATio [{<range>|AUTO|MIN|MAX|DEF} [, {<resolution>|MIN|MAX|DEF}]]

Measurement Commands

MEASure:CAPacitance? [{<range>|AUTO|MIN|MAX|DEF} [, {<resolution>|MIN|MAX|DEF}]]

MEASure:CONTinuity?

MEASure:CURRent:{AC|DC}? [{<range>|AUTO|MIN|MAX|DEF} [, {<resolution>|MIN|MAX|DEF}]]

MEASure:DIODE?

MEASure:{FREQuency|PERiod}? [{<range>|MIN|MAX|DEF} [, {<resolution>|MIN|MAX|DEF}]]

MEASure:{RESistance|FRESistance}? [{<range>|AUTO|MIN|MAX|DEF} [, {<resolution>|MIN|MAX|DEF}]]

MEASure:TEMPerature? [{FRTD|RTD|FTHermistor|THERmistor|TCouple|DEFault} [, {<type>|DEFault} [, 1 , {<resolution>|MIN|MAX|DEF}]]]]

MEASure[:VOLTage]:{AC|DC}? [{<range>|AUTO|MIN|MAX|DEF} [, {<resolution>|MIN|MAX|DEF}]]

MEASure[:VOLTage][:DC]:RATio? [{<range>|AUTO|MIN|MAX|DEF} [, {<resolution>|MIN|MAX|DEF}]]

Measurement Configuration Commands

[SENSe:]FUNCTion[:ON] "<function>"

[SENSe:]FUNCTion[:ON]?

AC and DC Voltage and DC Ratio Configuration Commands

```

CONFigure[:VOLTage]:{AC|DC} [{<range>|AUTO|MIN|MAX|DEF} [, {<resolution>|MIN|MAX|DEF}]]
CONFigure[:VOLTage][:DC]:RATio [{<range>|AUTO|MIN|MAX|DEF} [, {<resolution>|MIN|MAX|DEF}]]
CONFigure?

[SENSe:]VOLTage:AC:BANDwidth {<filter>|MIN|MAX|DEF}
[SENSe:]VOLTage:AC:BANDwidth? [{MIN|MAX|DEF}]

[SENSe:]VOLTage:{AC|DC}:NULL[:STATe] {OFF|ON}
[SENSe:]VOLTage:{AC|DC}:NULL[:STATe]?

[SENSe:]VOLTage:{AC|DC}:NULL:VALue {<value>|MIN|MAX|DEF}
[SENSe:]VOLTage:{AC|DC}:NULL:VALue? [{MIN|MAX|DEF}]

[SENSe:]VOLTage:{AC|DC}:NULL:VALue:AUTO {OFF|ON}
[SENSe:]VOLTage:{AC|DC}:NULL:VALue:AUTO?

[SENSe:]VOLTage:{AC|DC}:RANGe {<range>|MIN|MAX|DEF}
[SENSe:]VOLTage:{AC|DC}:RANGe? [{MIN|MAX|DEF}]

[SENSe:]VOLTage:{AC|DC}:RANGe:AUTO {OFF|ON|ONCE}
[SENSe:]VOLTage:{AC|DC}:RANGe:AUTO?

[SENSe:]VOLTage:AC:SECondary {"OFF"|"CALCulate:DATA"|"FREQuency"|"VOLTage[:DC]"}
[SENSe:]VOLTage:AC:SECondary?

[SENSe:]VOLTage[:DC]:APERture {<seconds>|MIN|MAX|DEF}
[SENSe:]VOLTage[:DC]:APERture? [{MIN|MAX|DEF}]

[SENSe:]VOLTage[:DC]:APERture:ENABled {OFF|ON}
[SENSe:]VOLTage[:DC]:APERture:ENABled?

[SENSe:]VOLTage[:DC]:IMPedance:AUTO {OFF|ON}
[SENSe:]VOLTage[:DC]:IMPedance:AUTO?

[SENSe:]VOLTage[:DC]:NPLC {<PLCs>|MIN|MAX|DEF}
[SENSe:]VOLTage[:DC]:NPLC? [{MIN|MAX|DEF}]

[SENSe:]VOLTage[:DC]:RATio:SECondary {"OFF"|"CALCulate:DATA"|"SENSe:DATA"}
[SENSe:]VOLTage[:DC]:RATio:SECondary?

[SENSe:]VOLTage[:DC]:RESolution {<resolution>|MIN|MAX|DEF}
[SENSe:]VOLTage[:DC]:RESolution? [{MIN|MAX|DEF}]

[SENSe:]VOLTage[:DC]:SECondary {"OFF"|"CALCulate:DATA"|"VOLTage:AC"|"PTPeak"}
[SENSe:]VOLTage[:DC]:SECondary?

[SENSe:]VOLTage[:DC]:ZERO:AUTO {OFF|ON|ONCE}
[SENSe:]VOLTage[:DC]:ZERO:AUTO?

```

2-Wire and 4-Wire Resistance Configuration Commands

CONFigure:{RESistance|FRESistance} [{<range>|AUTO|MIN|MAX|DEF} [, {<resolution>|MIN|MAX|DEF}]]

CONFigure?

[SENSe:]{RESistance|FRESistance}:APERTure {<seconds>|MIN|MAX|DEF}

[SENSe:]{RESistance|FRESistance}:APERTure? [{MIN|MAX|DEF}]

[SENSe:]{RESistance|FRESistance}:APERTure:ENABled {OFF|ON}

[SENSe:]{RESistance|FRESistance}:APERTure:ENABled?

[SENSe:]{RESistance|FRESistance}:NPLC {<PLCs>|MIN|MAX|DEF}

[SENSe:]{RESistance|FRESistance}:NPLC? [{MIN|MAX|DEF}]

[SENSe:]{RESistance|FRESistance}:NULL[:STATe] {OFF|ON}

[SENSe:]{RESistance|FRESistance}:NULL[:STATe]?

[SENSe:]{RESistance|FRESistance}:NULL:VALue {<value>|MIN|MAX|DEF}

[SENSe:]{RESistance|FRESistance}:NULL:VALue? [{MIN|MAX|DEF}]

[SENSe:]{RESistance|FRESistance}:NULL:VALue:AUTO {OFF|ON}

[SENSe:]{RESistance|FRESistance}:NULL:VALue:AUTO?

[SENSe:]{RESistance|FRESistance}:OCOMpensated {OFF|ON}

[SENSe:]{RESistance|FRESistance}:OCOMpensated?

[SENSe:]{RESistance|FRESistance}:POWER:LIMit[:STATe] {OFF|ON}

[SENSe:]{RESistance|FRESistance}:POWER:LIMit[:STATe]?

[SENSe:]{RESistance|FRESistance}:RANGe {<range>|MIN|MAX|DEF}

[SENSe:]{RESistance|FRESistance}:RANGe? [{MIN|MAX|DEF}]

[SENSe:]{RESistance|FRESistance}:RANGe:AUTO {OFF|ON|ONCE}

[SENSe:]{RESistance|FRESistance}:RANGe:AUTO?

[SENSe:]{RESistance|FRESistance}:RESolution {<resolution>|MIN|MAX|DEF}

[SENSe:]{RESistance|FRESistance}:RESolution? [{MIN|MAX|DEF}]

[SENSe:]{FRESistance|RESistance}:SECondary {"OFF"|"CALCulate:DATA"}

[SENSe:]{FRESistance|RESistance}:SECondary?

[SENSe:]RESistance:ZERO:AUTO {OFF|ON|ONCE}

[SENSe:]RESistance:ZERO:AUTO?

AC and DC Current Configuration Commands

CONFigure:CURRent:{AC|DC} [{<range>|AUTO|MIN|MAX|DEF} [, {<resolution>|MIN|MAX|DEF}]]

CONFigure?

[SENSe:]CURRent:AC:BANDwidth {<filter>|MIN|MAX|DEF}

[SENSe:]CURRent:AC:BANDwidth? [{MIN|MAX|DEF}]

[SENSe:]CURRent:{AC|DC}:NULL[:STATe] {OFF|ON}

[SENSe:]CURRent:{AC|DC}:NULL[:STATe]?

[SENSe:]CURRent:{AC|DC}:NULL:VALue {<value>|MIN|MAX|DEF}

[SENSe:]CURRent:{AC|DC}:NULL:VALue? [{MIN|MAX|DEF}]

[SENSe:]CURRent:{AC|DC}:NULL:VALue:AUTO {OFF|ON}

[SENSe:]CURRent:{AC|DC}:NULL:VALue:AUTO?

[SENSe:]CURRent:{AC|DC}:RANGe {<range>|MIN|MAX|DEF}

[SENSe:]CURRent:{AC|DC}:RANGe? [{MIN|MAX|DEF}]

[SENSe:]CURRent:{AC|DC}:RANGe:AUTO {OFF|ON|ONCE}

[SENSe:]CURRent:{AC|DC}:RANGe:AUTO?

[SENSe:]CURRent:{AC|DC}:TERMinals {3|10}

[SENSe:]CURRent:{AC|DC}:TERMinals?

[SENSe:]CURRent:AC:SECondary {"OFF"|"CALCulate:DATA"|"FREQuency"|"CURRent[:DC]"}]

[SENSe:]CURRent:AC:SECondary?

[SENSe:]CURRent[:DC]:APERTure {<seconds>|MIN|MAX|DEF}

[SENSe:]CURRent[:DC]:APERTure? [{MIN|MAX|DEF}]

[SENSe:]CURRent[:DC]:APERTure:ENABled {OFF|ON}

[SENSe:]CURRent[:DC]:APERTure:ENABled?

[SENSe:]CURRent[:DC]:NPLC {<PLCs>|MIN|MAX|DEF}

[SENSe:]CURRent[:DC]:NPLC? [{MIN|MAX|DEF}]

[SENSe:]CURRent[:DC]:RESolution {<resolution>|MIN|MAX|DEF}

[SENSe:]CURRent[:DC]:RESolution? [{MIN|MAX|DEF}]

[SENSe:]CURRent[:DC]:SECondary {"OFF"|"CALCulate:DATA"|"CURRent:AC"|"PTPeak"}

[SENSe:]CURRent[:DC]:SECondary?

[SENSe:]CURRent[:DC]:ZERO:AUTO {OFF|ON|ONCE}

[SENSe:]CURRent[:DC]:ZERO:AUTO?

[SENSe:]CURRent:SWITCh:MODE {FAST|CONTInuous}

[SENSe:]CURRent:SWITCh:MODE?

Capacitance Configuration Commands

CONFigure:CAPacitance [{<range>|AUTO|MIN|MAX|DEF} [, {<resolution>|MIN|MAX|DEF}]]

CONFigure?

[SENSe:]CAPacitance:NULL[:STATe] {OFF|ON}

[SENSe:]CAPacitance:NULL[:STATe]?

[SENSe:]CAPacitance:NULL:VALue {<value>|MIN|MAX|DEF}

[SENSe:]CAPacitance:NULL:VALue? [{MIN|MAX|DEF}]

[SENSe:]CAPacitance:NULL:VALue:AUTO {OFF|ON}

[SENSe:]CAPacitance:NULL:VALue:AUTO?

[SENSe:]CAPacitance:RANge {<range>|MIN|MAX|DEF}

[SENSe:]CAPacitance:RANge? [{MIN|MAX|DEF}]

[SENSe:]CAPacitance:RANge:AUTO {OFF|ON|ONCE}

[SENSe:]CAPacitance:RANge:AUTO?

[SENSe:]CAPacitance:SECondary{"OFF"|"CALCulate:DATA"}

[SENSe:]CAPacitance:SECondary?

Temperature Configuration Commands

CONFigure:TEMPerature [{FRTD|RTD|FTHermistor|THERmistor|TCouple|DEFault} [, {<type>|DEFault} [, 1 , {<resolution>|MIN|MAX|DEF}]]]

CONFigure?

[SENSe:]TEMPerature:APERture {<seconds>|MIN|MAX|DEF}

[SENSe:]TEMPerature:APERture? [{MIN|MAX|DEF}]

[SENSe:]TEMPerature:APERture:ENABled {OFF|ON}

[SENSe:]TEMPerature:APERture:ENABled?

[SENSe:]TEMPerature:NPLC {<PLCs>|MIN|MAX|DEF}

[SENSe:]TEMPerature:NPLC? [{MIN|MAX|DEF}]

[SENSe:]TEMPerature:NULL[:STATe] {OFF|ON}

[SENSe:]TEMPerature:NULL[:STATe]?

[SENSe:]TEMPerature:NULL:VALue {<value>|MIN|MAX|DEF}

[SENSe:]TEMPerature:NULL:VALue? [{MIN|MAX|DEF}]

[SENSe:]TEMPerature:NULL:VALue:AUTO {OFF|ON}

[SENSe:]TEMPerature:NULL:VALue:AUTO?

[SENSe:]TEMPerature:SECondary {"OFF"|"CALCulate:DATA"|"SENSe:DATA"}

[SENSe:]TEMPerature:SECondary?

[SENSe:]TEMPerature:TRANsdncer:{FRTD|RTD}:OCOMpensated {OFF|ON}

[SENSe:]TEMPerature:TRANsdncer:{FRTD|RTD}:OCOMpensated?

[SENSe:]TEMPerature:TRANsdncer:{FRTD|RTD}:POWER:LIMit[:STATe] {OFF|ON}

[SENSe:]TEMPerature:TRANsdncer:{FRTD|RTD}:POWER:LIMit[:STATe]?

[SENSe:]TEMPerature:TRANsdncer:{FRTD|RTD}:RESistance[:REFerence] {<reference>|MIN|MAX|DEF}

[SENSe:]TEMPerature:TRANsdncer:{FRTD|RTD}:RESistance[:REFerence]? [{MIN|MAX|DEF}]

[SENSe:]TEMPerature:TRANsdncer:{FTHermistor|THERmistor}:POWER:LIMit[:STATe] {OFF|ON}

[SENSe:]TEMPerature:TRANsdncer:{FTHermistor|THERmistor}:POWER:LIMit[:STATe]?

[SENSe:]TEMPerature:TRANsdncer:TCouple:CHECK {OFF|ON}

[SENSe:]TEMPerature:TRANsdncer:TCouple:CHECK?

```
[SENSe:]TEMPerature:TRANsdUcer:TCouple:RJUNction {<temperature>|MIN|MAX|DEF}
[SENSe:]TEMPerature:TRANsdUcer:TCouple:RJUNction? [{MIN|MAX|DEF}]

[SENSe:]TEMPerature:TRANsdUcer:TCouple:RJUNction:OFFSet:ADJust {<temperature>|MIN|MAX|DEF}
[SENSe:]TEMPerature:TRANsdUcer:TCouple:RJUNction:OFFSet:ADJust? [{MIN|MAX|DEF}]

[SENSe:]TEMPerature:TRANsdUcer:TCouple:RJUNction:TYPE {INTERNAL|FIXed}
[SENSe:]TEMPerature:TRANsdUcer:TCouple:RJUNction:TYPE?

[SENSe:]TEMPerature:TRANsdUcer:TCouple:TYPE {E|J|K|N|R|T}
[SENSe:]TEMPerature:TRANsdUcer:TCouple:TYPE?

[SENSe:]TEMPerature:TRANsdUcer:TYPE {FRTD|RTD|FThermistor|Thermistor|TCouple}
[SENSe:]TEMPerature:TRANsdUcer:TYPE?

[SENSe:]TEMPerature:ZERO:AUTO {OFF|ON|ONCE}
[SENSe:]TEMPerature:ZERO:AUTO?

UNIT:TEMPerature {C|F|K}
UNIT:TEMPerature?
```

Frequency/Period Configuration Commands

```
CONFigure:{FREQuency|PERiod} [{<range>|MIN|MAX|DEF} [, {<resolution>|MIN|MAX|DEF}]]
CONFigure?

[SENSe:]{FREQuency|PERiod}:APERture {<seconds>|MIN|MAX|DEF}
[SENSe:]{FREQuency|PERiod}:APERture? [{MIN|MAX|DEF}]

[SENSe:]{FREQuency|PERiod}:NULL[:STATe] {OFF|ON}
[SENSe:]{FREQuency|PERiod}:NULL[:STATe]?

[SENSe:]{FREQuency|PERiod}:NULL:VALue {<value>|MIN|MAX|DEF}
[SENSe:]{FREQuency|PERiod}:NULL:VALue? [{MIN|MAX|DEF}]

[SENSe:]{FREQuency|PERiod}:NULL:VALue:AUTO {OFF|ON}
[SENSe:]{FREQuency|PERiod}:NULL:VALue:AUTO?

[SENSe:]{FREQuency|PERiod}:RANGe:LOWer {<freq>|MIN|MAX|DEF}
[SENSe:]{FREQuency|PERiod}:RANGe:LOWer?

[SENSe:]{FREQuency|PERiod}:TIMEout:AUTO {OFF|ON}

[SENSe:]{FREQuency|PERiod}:VOLTage:RANGe {<range>|MIN|MAX|DEF}
[SENSe:]{FREQuency|PERiod}:VOLTage:RANGe? [{MIN|MAX|DEF}]

[SENSe:]{FREQuency|PERiod}:VOLTage:RANGe:AUTO {OFF|ON|ONCE}
[SENSe:]{FREQuency|PERiod}:VOLTage:RANGe:AUTO?

[SENSe:]FREQuency:SECondary {"OFF"|"CALCulate:DATA"|"PERiod"|"VOLTage:AC"}
[SENSe:]FREQuency:SECondary?

[SENSe:]PERiod:SECondary {"OFF"|"CALCulate:DATA"|"FREQuency"|"VOLTage:AC"}
[SENSe:]PERiod:SECondary?
```

Continuity and Diode Configuration Commands

```
CONFigure:CONTinuity
CONFigure:DIODE
```

Secondary Measurement Commands

```
[SENSe:]CAPacitance:SEConDary {"OFF"|"CALCulate:DATA"}
[SENSe:]CAPacitance:SEConDary?

[SENSe:]CURRent:AC:SEConDary {"OFF"|"CALCulate:DATA"|"FREQuency"|"CURRent[:DC]"}
[SENSe:]CURRent:AC:SEConDary?

[SENSe:]CURRent[:DC]:SEConDary {"OFF"|"CALCulate:DATA"|"CURRent:AC"|"PTPeak"}
[SENSe:]CURRent[:DC]:SEConDary?

[SENSe:]DATA2?

[SENSe:]DATA2:CLEar[:IMMediate]

[SENSe:]{FREStance|RESistance}:SEConDary {"OFF"|"CALCulate:DATA"}
[SENSe:]{FREStance|RESistance}:SEConDary?

[SENSe:]FREQuency:SEConDary {"OFF"|"CALCulate:DATA"|"PERiod"|"VOLTage:AC"}
[SENSe:]PERiod:SEConDary {"OFF"|"CALCulate:DATA"|"FREQuency"|"VOLTage:AC"}

[SENSe:]TEMPerature:SEConDary {"OFF"|"CALCulate:DATA"|"SENSe:DATA"}
[SENSe:]TEMPerature:SEConDary?

[SENSe:]VOLTage:AC:SEConDary {"OFF"|"CALCulate:DATA"|"FREQuency"|"VOLTage[:DC]"}
[SENSe:]VOLTage:AC:SEConDary?

[SENSe:]VOLTage[:DC]:RATio:SEConDary {"OFF"|"CALCulate:DATA"|"SENSe:DATA"}
[SENSe:]VOLTage[:DC]:RATio:SEConDary?

[SENSe:]VOLTage[:DC]:SEConDary {"OFF"|"CALCulate:DATA"|"VOLTage:AC"|"PTPeak"}
[SENSe:]VOLTage[:DC]:SEConDary?
```

Miscellaneous Configuration Commands

```
ROUTe:TERMinals?
```

Sample Commands

```

SAMPLE:COUNT {<count>|MIN|MAX|DEF}
SAMPLE:COUNT? [{MIN|MAX|DEF}]

SAMPLE:COUNT:PRETrigger {<count>|MIN|MAX|DEF}
SAMPLE:COUNT:PRETrigger? [{MIN|MAX|DEF}]

SAMPLE:SOURce {IMMediate|TIMER}
SAMPLE:SOURce?

SAMPLE:TIMER {<interval>|MIN|MAX|DEF}
SAMPLE:TIMER? [{MIN|MAX|DEF}]

```

Triggering Commands

```

ABORt

INITiate[:IMMediate]

OUTPut:TRIGger:SLOPe {POSitive|NEGative}
OUTPut:TRIGger:SLOPe?

READ?

SAMPLE:COUNT {<count>|MIN|MAX|DEF}
SAMPLE:COUNT? [{MIN|MAX|DEF}]

SAMPLE:COUNT:PRETrigger {<count>|MIN|MAX|DEF}
SAMPLE:COUNT:PRETrigger? [{MIN|MAX|DEF}]

*TRG

TRIGger:COUNT {<count>|MIN|MAX|DEF|INFINITY}
TRIGger:COUNT? [{MIN|MAX|DEF}]

TRIGger:DElay {<seconds>|MIN|MAX|DEF}
TRIGger:DElay? [{MIN|MAX|DEF}]

TRIGger:DElay:AUTO {OFF|ON}
TRIGger:DElay:AUTO?

TRIGger:LEVel {<level>|MIN|MAX|DEF}
TRIGger:LEVel? [{MIN|MAX|DEF}]

TRIGger:SLOPe {POSitive|NEGative}
TRIGger:SLOPe?

TRIGger:SOURce {IMMediate|EXternal|BUS|INTERNAL}
TRIGger:SOURce?

```

Calculation (Math) Commands

Overall

CALCulate:CLEar[:IMMediate]

Histogram

CALCulate:TRANSform:HISTogram:ALL?

CALCulate:TRANSform:HISTogram:CLEar[:IMMediate]

CALCulate:TRANSform:HISTogram:COUNT?

CALCulate:TRANSform:HISTogram:DATA?

CALCulate:TRANSform:HISTogram:POINTs {<value>|MIN|MAX|DEF}

CALCulate:TRANSform:HISTogram:POINTs? [{MIN|MAX|DEF}]

CALCulate:TRANSform:HISTogram:RANGE:AUTO {OFF|ON}

CALCulate:TRANSform:HISTogram:RANGE:AUTO?

CALCulate:TRANSform:HISTogram:RANGE:{LOWer|UPPer} {<value>|MIN|MAX|DEF}

CALCulate:TRANSform:HISTogram:RANGE:{LOWer|UPPer}? [{MIN|MAX|DEF}]

CALCulate:TRANSform:HISTogram[:STATe] {OFF|ON}

CALCulate:TRANSform:HISTogram[:STATe]?

Limit Testing

CALCulate:LIMit:CLEar[:IMMediate]

CALCulate:LIMit:{LOWer|UPPer}[:DATA] {<value>|MIN|MAX|DEF}

CALCulate:LIMit:{LOWer|UPPer}[:DATA]? [{MIN|MAX|DEF}]

CALCulate:LIMit[:STATe] {OFF|ON}

CALCulate:LIMit[:STATe]?

Scaling

CALCulate:SCALE:DB:REfERENCE {<reference>|MIN|MAX|DEF}
 CALCulate:SCALE:DB:REfERENCE? [{MIN|MAX|DEF}]

CALCulate:SCALE:DBM:REfERENCE {<reference>|MIN|MAX|DEF}
 CALCulate:SCALE:DBM:REfERENCE? [{MIN|MAX|DEF}]

CALCulate:SCALE:FUNCTion {DB|DBM|PCT|SCALE}

CALCulate:SCALE:FUNCTion?

CALCulate:SCALE:GAIN {<gain>|MIN|MAX|DEF}
 CALCulate:SCALE:GAIN? [{MIN|MAX|DEF}]

CALCulate:SCALE:OFFSet {<offset>|MIN|MAX|DEF}
 CALCulate:SCALE:OFFSet? [{MIN|MAX|DEF}]

CALCulate:SCALE:REfERENCE:AUTO {OFF|ON}
 CALCulate:SCALE:REfERENCE:AUTO?

CALCulate:SCALE:REfERENCE {<reference>|MIN|MAX|DEF}
 CALCulate:SCALE:REfERENCE? [{MIN|MAX|DEF}]

CALCulate:SCALE[:STATe] {OFF|ON}
 CALCulate:SCALE[:STATe]?

CALCulate:SCALE:UNIT <quoted_string>
 CALCulate:SCALE:UNIT?

CALCulate:SCALE:UNIT:STATe {OFF|ON}
 CALCulate:SCALE:UNIT:STATe?

Statistics

CALCulate:AVERage:ALL?
CALCulate:AVERage:AVERage?
CALCulate:AVERage:CLEar[:IMMEDIATE]
CALCulate:AVERage:COUNT?
CALCulate:AVERage:MAXimum?
CALCulate:AVERage:MINimum?
CALCulate:AVERage:PTPeak?
CALCulate:AVERage:SDEVIation?
CALCulate:AVERage[:STATe] {OFF|ON}
CALCulate:AVERage[:STATe]?

Smoothing

CALCulate:SMOothing:RESPonse {SLOW|MEDIUM|FAST}
CALCulate:SMOothing:RESPonse?
CALCulate:SMOothing[:STATe] {OFF|ON}
CALCulate:SMOothing[:STATe]?

Trend Chart

CALCulate:TCHart[:STATe] {OFF|ON}
CALCulate:TCHart[:STATe]?

Reading Memory Commands

DATA:LAST?
DATA:POINTS:EVENT:THREShold <count>
DATA:POINTS:EVENT:THREShold?
DATA:POINTS?
DATA:REMOve? <num_readings> [,WAIT]
FETCh?
R? [<max_readings>]

Calibration Commands

```

*CAL?
CALibration:ADC?
CALibration[:ALL]?
CALibration:COUNT?
CALibration:DATE?
CALibration:SECure:CODE <new_code>
CALibration:SECure:STATe {OFF|ON} [, <code>]
CALibration:SECure:STATe?
CALibration:STORe
CALibration:STRing "<string>"
CALibration:STRing?
CALibration:TEMPerature?
CALibration:TIME?
CALibration:VALue <value>
CALibration:VALue?
SYSTem:ACALibration:DATE?
SYSTem:ACALibration:TEMPerature?
SYSTem:ACALibration:TIME?

```

State Storage and Preferences Commands

```

*LRN?
MMEMory:LOAD:PREFerences <file>
MMEMory:LOAD:STATe <file>
MMEMory:STORe:PREFerences <file>
MMEMory:STORe:STATe <file>
MMEMory:STATe:RECall:AUTO {OFF|ON}
MMEMory:STATe:RECall:AUTO?
MMEMory:STATe:RECall:SElect <file>
MMEMory:STATe:RECall:SElect?
MMEMory:STATe:VALid? <file>
*RCL {0|1|2|3|4}
*SAV {0|1|2|3|4}

```

General Purpose File Management Commands

MMEemory:CATalog[:ALL]? [*<folder>* [*<filespec>*]]

MMEemory:CDIRectory *<folder>*

MMEemory:CDIRectory?

MMEemory:COpy *<file1>*, *<file2>*

MMEemory:DElete {*<file>*|*<filespec>*}

MMEemory:MDIRectory *<folder>*

MMEemory:MOVE *<file1>*, *<file2>*

MMEemory:RDIRectory *<folder>*

Data Transfer Commands

MMEMory:DOWNload:DATA <*binary_block*>
 MMEMory:DOWNload:FNAME <*file*>
 MMEMory:DOWNload:FNAME?
 MMEMory:FORMat:READing:CSEParator {COMMa|SEMIColon|TAB}
 MMEMory:FORMat:READing:CSEParator?
 MMEMory:FORMat:READing:INformation {OFF|ON}
 MMEMory:FORMat:READing:INformation?
 MMEMory:FORMat:READing:RLIMit {OFF|ON}
 MMEMory:FORMat:READing:RLIMit?
 MMEMory:STORe:DATA RDG_STORE, <*file*>
 MMEMory:UPLoad? <*file*>

IEEE-488 Commands

*CAL?
 *CLS
 *ESE <*enable_value*>
 *ESE?
 *ESR?
 *IDN?
 *LRN?
 *OPC
 *OPC?
 *OPT?
 *PSC {0|1}
 *PSC?
 *RCL {0|1|2|3|4}
 *RST
 *SAV {0|1|2|3|4}
 *SRE <*enable_value*>
 *SRE?
 *STB?
 *TRG
 *TST?
 *WAI

Format Subsystem

FORMat:BORDer {NORMal|SWAPped}
 FORMat:BORDer?

FORMat[:DATA] {ASCIi|REAL} [, <length>]
 FORMat[:DATA]?

System-Related Commands

*CAL?

DISPlay[:STATe] {OFF|ON}
 DISPlay[:STATe]?

DISPlay:TEXT:CLEar

DISPlay:TEXT[:DATA] "<string>"
 DISPlay:TEXT[:DATA]?

DISPlay:VIEW {NUMeric|HISTogram|TCHart|METER}
 DISPlay:VIEW?

HCOPy:SDUMp:DATA:FORMat {PNG|BMP}
 HCOPy:SDUMp:DATA:FORMat?

HCOPy:SDUMp:DATA?

*IDN?

LXI:IDENtify[:STATe] {OFF|ON}
 LXI:IDENtify[:STATe]?

LXI:MDNS:ENABle {OFF|ON}
 LXI:MDNS:ENABle?

LXI:MDNS:HNAME[:RESolved]?

LXI:MDNS:SNAME:DESired "<name>"
 LXI:MDNS:SNAME:DESired?

LXI:MDNS:SNAME[:RESolved]?

LXI:RESet

LXI:REStart

*RST

SYSTem:ACALibration:DATE?

SYSTem:ACALibration:TEMPerature?

SYSTem:ACALibration:TIME?

SYSTem:BEEPer[:IMMEDIATE]

SYSTem:BEEPer:STATe {OFF|ON}
 SYSTem:BEEPer:STATe?

SYSTem:CLICk:STATe {OFF|ON}
 SYSTem:CLICk:STATe?

SYSTem:DATE <year>, <month>, <day>
 SYSTem:DATE?

SYSTem:ERRor[:NEXT]?
 SYSTem:HELP?
 SYSTem:IDENtify {DEfault|AT34460A|AT34461A|AT34410A|AT34411A|HP34401A}*
 SYSTem:IDENtify?
 SYSTem:LABel "<string>"
 SYSTem:LABel?
 SYSTem:PRESet
 SYSTem:SECurity:COUNT?
 SYSTem:SECurity:IMMediate
 SYSTem:TEMPerature?
 SYSTem:TIME <hour>, <minute>, <second>
 SYSTem:TIME?
 SYSTem:UPTime?
 SYSTem:USB:HOST:ENABLE {OFF|ON}
 SYSTem:USB:HOST:ENABLE?
 SYSTem:VERSion?
 SYSTem:WMESsage "<string>"
 SYSTem:WMESsage?
 TEST:ALL?
 *TST?

**Parameters vary by DMM model number. See [SYSTem:IDENtify](#) for details.*

Interface Locking Commands

SYSTem:LOCK:NAME?
 SYSTem:LOCK:OWNer?
 SYSTem:LOCK:RELease
 SYSTem:LOCK:REQuest?

License Management Commands

SYSTem:LICense:CATalog?
 SYSTem:LICense:DELeTe "<option_name>"
 SYSTem:LICense:DELeTe:ALL
 SYSTem:LICense:DESCRiption? "<option_name>"
 SYSTem:LICense:ERRor?
 SYSTem:LICense:ERRor:COUNT?
 SYSTem:LICense:INStall [{<folder>|<file>}]
 SYSTem:LICense:INStall? "<option_name>"

Interface Configuration Commands

SYSTem:COMMunicate:ENABle {OFF|ON}, {GPIB|HISLip|USB|LAN|SOCKets|TELNet|VXI11|WEB|USBMtp|USBHost}
 SYSTem:COMMunicate:ENABle? {GPIB|HISLip|USB|LAN|SOCKets|TELNet|VXI11|WEB|USBMtp|USBHost}

SYSTem:COMMunicate:GPIB:ADDRes <address>
 SYSTem:COMMunicate:GPIB:ADDRes?

SYSTem:COMMunicate:LAN:CONTRol?

SYSTem:COMMunicate:LAN:DHCP {OFF|ON}
 SYSTem:COMMunicate:LAN:DHCP?

SYSTem:COMMunicate:LAN:DNS[{1|2}] "<address>"
 SYSTem:COMMunicate:LAN:DNS[{1|2}]? [{CURRent|STATic}]

SYSTem:COMMunicate:LAN:DOMain?

SYSTem:COMMunicate:LAN:GATeway "<address>"
 SYSTem:COMMunicate:LAN:GATeway? [{CURRent|STATic}]

SYSTem:COMMunicate:LAN:HOSTname "<name>"
 SYSTem:COMMunicate:LAN:HOSTname? [{CURRent|STATic}]

SYSTem:COMMunicate:LAN:IPADdress "<address>"
 SYSTem:COMMunicate:LAN:IPADdress? [{CURRent|STATic}]

SYSTem:COMMunicate:LAN:MAC?

SYSTem:COMMunicate:LAN:SMASk "<mask>"
 SYSTem:COMMunicate:LAN:SMASk? [{CURRent|STATic}]

SYSTem:COMMunicate:LAN:TELNet:PROMpt "<string>"
 SYSTem:COMMunicate:LAN:TELNet:PROMpt?

SYSTem:COMMunicate:LAN:TELNet:WMESsage "<string>"
 SYSTem:COMMunicate:LAN:TELNet:WMESsage?

SYSTem:COMMunicate:LAN:UPDate

SYSTem:COMMunicate:LAN:WINS[{1|2}] "<address>"
 SYSTem:COMMunicate:LAN:WINS[{1|2}]? [{CURRent|STATic}]

SYSTem:USB:HOST:ENABle {OFF|ON}
 SYSTem:USB:HOST:ENABle?

Status System Commands

*CLS

*ESE <enable_value>

*ESE?

*ESR?

*PSC {0|1}

*PSC?

*SRE <enable_value>

*SRE?

STATus:OPERation:CONDition?

STATus:OPERation:ENABle <enable_value>

STATus:OPERation:ENABle?

STATus:OPERation[:EVENT]?

STATus:PRESet

STATus:QUEStionable:CONDition?

STATus:QUEStionable:ENABle <enable_value>

STATus:QUEStionable:ENABle?

STATus:QUEStionable[:EVENT]?

*STB?

Range, Resolution and Integration Time (shown in Aperture and NPLCs)

The following three tables show the integration time (in PLC and seconds) for each range and resolution.

To determine the PLC for a specified range and resolution:

1. Locate the range in the left column. Measurement units do not apply (i.e. for 1 V or 1 A, use the 1 range; for 100 V or 100 Ω, use the 100 range).
2. From the range value, follow the corresponding row of resolutions to the right until the specified resolution lies within two adjacent columns for your DMM model.
3. The NPLC value at the top of the left-adjacent column is the NPLC "setting" for the given range and resolution.

For example: for the 34461A, a specified 10 VDC range and 10 μV resolution, locate range 10 in the table. Moving to the right, the 10 μV resolution (1E-5) is found in the column under 10 NPLC.

Model	34460A					34461A				
PLC	100	10	1	0.2	0.02	100	10	1	0.2	0.02
Aperture (60 Hz Power)	1.67s	0.167s	16.7ms	3ms	0.3ms	1.67s	0.167s	16.7ms	3ms	0.3ms
Aperture (50 Hz Power)	2s	0.2s	20ms			2s	0.2s	20ms		
ResFactor ¹	3ppm	10ppm	30ppm	100ppm	300ppm	0.3ppm	1ppm	3ppm	10ppm	100ppm
Range	Resolution									
1 m	3E-9	1E-8	3E-8	1E-7	3E-7	3E-10	1E-9	3E-9	1E-8	1E-7
10 m	3E-8	1E-7	3E-7	1E-6	3E-6	3E-9	1E-8	3E-8	1E-7	1E-6
100 m	3E-7	1E-6	3E-6	1E-5	3E-5	3E-8	1E-7	3E-7	1E-6	1E-5
1	3E-6	1E-5	3E-5	1E-4	3E-4	3E-7	1E-6	3E-6	1E-5	1E-4
10	3E-5	1E-4	3E-4	1E-3	3E-3	3E-6	1E-5	3E-5	1E-4	1E-3
100	3E-4	1E-3	3E-3	1E-2	3E-2	3E-5	1E-4	3E-4	1E-3	1E-2
1 k	3E-3	1E-2	3E-2	1E-1	3E-1	3E-4	1E-3	3E-3	1E-2	1E-1
10 k	3E-2	1E-1	3E-1	1	3	3E-3	1E-2	3E-2	1E-1	1
100 k	3E-1	1	3	10	30	3E-2	1E-1	3E-1	1	10
1 M	3	10	30	100	300	3E-1	1	3	10	100
10 M	30	100	300	1 k	3 k	3	10	30	100	1 k
100 M	300	1 k	3 k	10 k	30 k	30	100	300	1 k	10 k

¹ResFactor x Range = Resolution.

Model	34465A								
PLC	100	10	1	0.2	0.06	0.02	0.006 ²	0.002 ²	0.001 ²
Aperture (60 Hz Power)	1.67s	0.167s	16.7ms	3ms	1ms	0.3ms	100 μs ²	40 μs ²	20 μs ²
Aperture (50 Hz Power)	2s	0.2s	20ms						
ResFactor ¹	0.03 ppm	0.1 ppm	0.3 ppm	0.7 ppm	1.5 ppm	3 ppm	6 ppm	15 ppm	30 ppm
Range	Resolution								
1 m	30E-12	100E-12	300E-12	700E-12	1.5E-9	3E-9	6E-9	15E-9	30E-9
10 m	300E-12	1E-9	3E-9	7E-9	1.5E-8	3E-8	6E-8	15E-8	30E-8
100 m	3E-9	1E-8	3E-8	7E-8	1.5E-7	3E-7	6E-7	15E-7	30E-7
1	3E-8	1E-7	3E-7	7E-7	1.5E-6	3E-6	6E-6	15E-6	30E-6
10	3E-7	1E-6	3E-6	7E-6	1.5E-5	3E-5	6E-5	15E-5	30E-5
100	3E-6	1E-5	3E-5	7E-5	1.5E-4	3E-4	6E-4	15E-4	30E-4
1 k	3E-5	1E-4	3E-4	7E-4	1.5E-3	3E-3	6E-3	15E-3	30E-3
10 k	3E-4	1E-3	3E-3	7E-3	1.5E-2	3E-2	6E-2	15E-2	30E-2
100 k	3E-3	1E-2	3E-2	7E-2	1.5E-1	3E-1	6E-1	15E-1	30E-1
1 M	3E-2	1E-1	3E-1	7E-1	1.5	3	6	15	30
10 M	3E-1	1	3	7	15	30	60	150	300
100 M	3	10	30	70	150	300	600	1.5 k	3 k
1 G	30	100	300	700	1.5 k	3 k	6 k	15 k	30 k

Model	34470A								
PLC	100	10	1	0.2	0.06	0.02	0.006 ²	0.002 ²	0.001 ²
Aperture (60 Hz Power)	1.67s	0.167s	16.7ms	3ms	1ms	0.3ms	100 μs ²	40 μs ²	20 μs ²
Aperture (50 Hz Power)	2s	0.2s	20ms						
ResFactor ¹	0.01 ppm	0.03 ppm	0.1 ppm	0.3 ppm	0.5 ppm	1 ppm	3 ppm	10 ppm	30 ppm
Range	Resolution								
1 m	10E-12	30E-12	100E-12	300E-12	500E-12	1E-9	3E-9	10E-9	30E-9
10 m	100E-12	300E-12	1E-9	3E-9	5E-9	1E-8	3E-8	10E-8	30E-8
100 m	1E-9	3E-9	1E-8	3E-8	5E-8	1E-7	3E-7	10E-7	30E-7
1	1E-8	3E-8	1E-7	3E-7	5E-7	1E-6	3E-6	10E-6	30E-6
10	1E-7	3E-7	1E-6	3E-6	5E-6	1E-5	3E-5	10E-5	30E-5
100	1E-6	3E-6	1E-5	3E-5	5E-5	1E-4	3E-4	10E-4	30E-4
1 k	1E-5	3E-5	1E-4	3E-4	5E-4	1E-3	3E-3	10E-3	30E-3
10 k	1E-4	3E-4	1E-3	3E-3	5E-3	1E-2	3E-2	10E-2	30E-2
100 k	1E-3	3E-3	1E-2	3E-2	5E-2	1E-1	3E-1	10E-1	30E-1
1 M	1E-2	3E-2	1E-1	3E-1	5E-1	1	3	10	30
10 M	1E-1	3E-1	1	3	5	10	30	100	300
100 M	1	3	10	30	50	100	300	1 k	3 k
1 G	10	30	100	300	500	1 k	3 k	10 k	30 k

¹ResFactor x Range = Resolution., ² 34465A/70A with DIG option only.

Resolution and Integration Time for DC Measurements

Setting the integration time also sets the measurement resolution. This table shows the relationship between integration time in power line cycles (PLC) and resolution.

Integration Time			Resolution (34460A)	Resolution (34461A)	Resolution (34465A)	Resolution (34470A)
Power Line Cycles	Aperture (60 Hz Power)	Aperture (50 Hz Power)				
0.001 PLC ¹	20 μ s ¹		-	-	30 ppm x Range	30 ppm x Range
0.002 PLC ¹	40 μ s ¹		-	-	15 ppm x Range	10 ppm x Range
0.006 PLC ¹	100 μ s ¹		-	-	6 ppm x Range	3 ppm x Range
0.02 PLC (MINimum)	0.3 ms		300 ppm x Range (MAXimum)	100 ppm x Range (MAXimum)	3 ppm x Range	1 ppm x Range
0.06 PLC	1 ms		-	-	1.5 ppm x Range	0.5 ppm x Range
0.2 PLC	3 ms		100 ppm x Range	10 ppm x Range	0.7 ppm x Range	0.3 ppm x Range
1 PLC	16.7 ms	20 ms	30 ppm x Range	3 ppm x Range	0.3 ppm x Range	0.1 ppm x Range
10 PLC (DEFault)	0.167 s	0.2 s	10 ppm x Range (DEFault)	1 ppm x Range (DEFault)	0.1 ppm x Range	0.03 ppm x Range
100 PLC (MAXimum)	1.67 s	2 s	3 ppm x Range (MINimum)	0.3 ppm x Range (MINimum)	0.03 ppm x Range	0.01 ppm x Range

¹34465A/70A with DIG option only.

Automatic Trigger Delays

If TRIGger:DElay:AUTO is on, the instrument selects the trigger delay for you, as shown in the tables below.

NOTE All frequency and period measurements have an automatic trigger delay of 1 second.

The continuity and diode functions ignore the trigger delay.

The 2-wire and 4-wire temperature measurements use the corresponding 2-wire and 4-wire resistance measurement delays.

DC Voltage Default Delays

PLC	0.001 ¹	0.002 ¹	0.006 ¹	0.02	0.06 ²	0.2	1	10	100
Aperture (60 Hz Power)	20 μ s ¹	40 μ s ¹	100 μ s ¹	0.3 ms	1 ms ²	3 ms	16.7 ms	0.167 s	1.67 s
Aperture (50 Hz Power)							20 ms	0.2 s	2 s
Range	Delay								
All	100 μ s			130 μ s			160 μ s		

¹ 34465A/70A with DIG option only.

²34465A/70A only.

DC Current Default Delays

PLC	0.001 ¹	0.002 ¹	0.006 ¹	0.02	0.06 ²	0.2	1	10	100
Aperture (60 Hz Power)	20 μ s ¹	40 μ s ¹	100 μ s ¹	0.3 ms	1 ms ²	3 ms	16.7 ms	0.167 s	1.67 s
Aperture (50 Hz Power)							20 ms	0.2 s	2 s
Range	Delay								
All	1 ms						1.5 ms		

¹ 34465A/70A with DIG option only.

² 34465A/70A only.

Resistance (2-wire) Default Delays

PLC	0.001 ¹	0.002 ¹	0.006 ¹	0.02	0.06 ²	0.2	1	10	100
Aperture (60 Hz Power)	20 μ s ¹	40 μ s ¹	100 μ s ¹	0.3 ms	1 ms ²	3 ms	16.7 ms	0.167 s	1.67 s
Aperture (50 Hz Power)							20 ms	0.2 s	2 s
Range	Delay								
100 Ω	80 μ s			100 μ s		130 μ s			
1 k Ω	110 μ s			130 μ s		160 μ s			
10 k Ω	130 μ s			160 μ s		190 μ s			
100 k Ω	540 μ s			670 μ s		800 μ s			
1 M Ω	5 ms			6 ms		7.5 ms			
10 M Ω	60 ms			70 ms		84 ms			
100 M Ω									
1 G Ω ²									

¹ 34465A/70A with DIG option only.

² 34465A/70A only.

Resistance (4-wire) Default Delays

PLC	0.001 ¹	0.002 ¹	0.006 ¹	0.02	0.06 ²	0.2	1	10	100
Aperture (60 Hz Power)	20 μ s ¹	40 μ s ¹	100 μ s ¹	0.3 ms	1 ms ²	3 ms	16.7 ms	0.167 s	1.67 s
Aperture (50 Hz Power)							20 ms	0.2 s	2 s
Range	Delay								
100 Ω	1 ms					1.5 ms			
1 k Ω									
10 k Ω									
100 k Ω									
1 M Ω	10 ms					15 ms			
10 M Ω	100 ms								
100 M Ω									
1 G Ω ²									

¹ 34465A/70A with DIG option only.

² 34465A/70A only.

AC Voltage Default Delays

	Filter (Hz)		
Range	3	20	200
All	2.5 s	0.625 s	0.025 s

AC Current Default Delays

	Filter (Hz)		
Range	3	20	200
All	1.66 s	0.25 s	0.025 s

Frequency and Period

The default delay for frequency and period is 1 s, regardless of aperture (gate time) setting.

VM Comp Output (BNC)

The rear-panel VM Comp (voltmeter complete) output provides a 3.3 V pulse after each measurement completion to implement a standard hardware handshake sequence between measurement and switching devices.

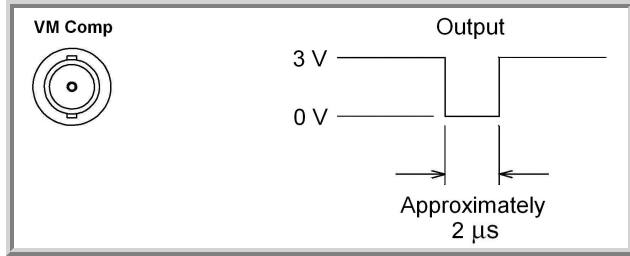

The signal shown is for a negative pulse.

SCPI Error Messages

[Command Errors \(-100...\)](#)

[Execution Errors \(-200...\)](#)

[Device-Specific Errors \(-300...\)](#)

[Query Errors \(-400...\)](#)

[Network Errors \(+100...\)](#)

[Instrument Errors \(+200...\)](#)

[Miscellaneous Errors \(+300... and +500..\)](#)

[Licensing and Self-test Errors \(+600...\)](#)

[Calibration Errors \(+700...\)](#)

[Miscellaneous Errors \(+800...\)](#)

The instrument returns error messages in accordance with the SCPI standard.

- Up to 20 errors can be stored in the instrument's error queue. Each remote interface I/O session (GPIB, USB, VXI-11, Telnet/Sockets) has its own interface-specific error queue. Errors appear in the error queue of the I/O session that caused the error. For example, if an error was generated by a command sent over GPIB, send [SYSTem:ERRor?](#) from GPIB to read the error queue. Errors generated by instrument hardware are broadcast to all I/O sessions.
- The instrument beeps each time an error is generated (unless disabled by [SYSTem:BEEPer:STATe OFF](#)). The front panel **Error** annunciator turns on when one or more errors are in the error queue.
- A special global error queue holds all power-on and hardware-related errors (for example, over-temperature).
- Error retrieval is first-in-first-out (FIFO), and errors are cleared as you read them. When you have read all of the interface-specific errors, the errors in the global error queue are retrieved. When you have read all errors from the interface-specific and global error queues, the **Error** annunciator turns off.
- If more than 20 errors have occurred, the most recent error stored in the queue is replaced with -350, "Queue overflow". No additional errors are stored until you remove errors from the queue. If no errors have occurred when you read the error queue, the instrument responds with +0, "No error".
- The front panel reports errors from all I/O sessions and the global error queue. To read the error queue from the front panel, press **Help > View remote command error queue**.
- Error conditions are also summarized in the Status Byte Register. For more information on the SCPI Status System, see [Status Subsystem Introduction](#).
- The interface-specific error queues are cleared by the [*CLS](#) (Clear Status) command and when power is cycled. All errors are cleared when you read the error queue. The error queue is not cleared by a Factory Reset ([*RST](#)) or an Instrument Preset ([SYSTem:PRESet](#)).

- **Front Panel:**

If the **Error** annunciator is on, there are errors in the error queue. The **Remote** annunciator is likely on as well. Press the **Local** key to return to local operation (the **Remote** annunciator goes off). Then press **[Help]**, select "View remote command error queue" in the menu and press **Select**. Use the menu navigation "arrow" keys to view the error messages. Press **Back** to exit and clear the error queue.

- **SCPI:**

SYSTem:ERRor? Read and clear one error from the queue

Errors have the following format (the error string may contain up to 80 characters):

`-113,"Undefined header"`

Command Errors (-100...)

- 100,"Command error"
- 101,"Invalid character"
- 102,"Syntax error"
- 103,"Invalid separator"
- 104,"Data type error"
- 105,"GET not allowed"
- 108,"Parameter not allowed"
- 109,"Missing parameter"
- 110,"Command header error"
- 111,"Header separator error"
- 112,"Program mnemonic too long"
- 113,"Undefined header"
- 114,"Header suffix out of range"
- 120,"Numeric data error"
- 121,"Invalid character in number"
- 123,"Exponent too large"
- 123,"Numeric overflow"
- 124,"Too many digits"
- 128,"Numeric data not allowed"
- 130,"Suffix error"
- 131,"Invalid suffix"
- 134,"Suffix too long"
- 138,"Suffix not allowed"
- 140,"Character data error"
- 141,"Invalid character data"
- 144,"Character data too long"
- 148,"Character data not allowed"
- 150,"String data error"
- 151,"Invalid string data"
- 158,"String data not allowed"

SCPI Programming Reference

-160,"Block data error"

-161,"Invalid block data"

-168,"Block data not allowed"

Execution Errors (-200...)

- 203,"Command protected"
- 203,"Command protected; feature not available on this model"
- 203,"Command protected; instrument must be unsecured"
- 203,"Command protected; large memory requires license MEM"
- 203,"Command protected; License required"
- 203,"Command protected; requires license DIG"
- 203,"Command protected; requires license LAN"
- 203,"Command protected; requires license SEC"
- 203,"Secure option: Instrument security is unlocked"
- 210,"Trigger error"
- 211,"Trigger ignored"
- 213,"Init ignored"
- 214,"Trigger deadlock"
- 220,"Parameter error"
- 221,"Settings conflict"
- 221,"Settings conflict; *TRG when TRIG:SOUR BUS not selected; trigger ignored"
- 221,"Settings conflict; 10A current terminals not available with rear terminals; terminals set to 3A"
- 221,"Settings conflict; CALC not allowed in current measurement function; CALC:STAT OFF set"
- 221,"Settings conflict; CALC:SCAL:REF 0.0 not compatible with CALC:SCAL:FUNC PCT; CALC:SCAL:STATE OFF set"
- 221,"Settings conflict; cannot delete state selected and enabled for automatic power-on recall"
- 221,"Settings conflict; cannot meet requested timing; SAMP:TIM changed"
- 221,"Settings conflict; cannot meet requested timing; TRIG:DEL changed"
- 221,"Settings conflict; histogram lower range > upper range; CALC:TRAN:HIST:RANG:AUTO ON set"
- 221,"Settings conflict; histogram not allowed in current measurement function; CALC:TRAN:HIST:STAT OFF set"
- 221,"Settings conflict; internal trigger not allowed in current measurement function; TRIG:SOUR IMM selected"
- 221,"Settings conflict; limit test not allowed in current measurement function; CALC:LIM:STAT OFF set"
- 221,"Settings conflict; lower limit > upper limit; CALC:LIM:UPP set to CALC:LIM:LOW value"
- 221,"Settings conflict; offset compensation not allowed with low power ohms; low power disabled"

- 221, "Settings conflict; pretrigger count limited to 10,000 with CALC enabled; SAMP:COUN:PRET changed"
- 221, "Settings conflict; pretrigger not supported on current measurement function; SAMP:COUN:PRET 0 set"
- 221, "Settings conflict; pretrigger SAMP:COUN:PRETrig >= SAMP:COUN; SAMP:COUN:PRET changed"
- 221, "Settings conflict; SAMP:COUN limited to memory size in pretrigger mode; SAMP:COUN changed"
- 221, "Settings conflict; scaling not allowed in current measurement function; CALC:SCAL:STAT OFF set"
- 221, "Settings conflict; smoothing not allowed in current measurement function; CALC:SMO:STAT OFF set"
- 221, "Settings conflict; statistics not allowed in current measurement function; CALC:AVER:STAT OFF set"
- 221, "Settings conflict; TRIG:LEVel value < minimum for current measurement function/range; TRIG:LEV MIN selected"
- 221, "Settings conflict; TRIG:LEVel value > maximum for current measurement function/range; TRIG:LEV MAX selected"
- 221, "Settings conflict; trigger count must be 1 in pretrigger mode; TRIG:COUN 1 set"
- 221, "Settings conflict; trigger source is BUS"
- 222, "Data out of range"
- 222, "Data out of range; value clipped to lower limit"
- 222, "Data out of range; value clipped to upper limit"
- 222, "Data out of range; value requires license DIG"
- 222, "Data out of range; value requires license MEM"
- 223, "Too much data"
- 224, "Illegal parameter value"
- 225, "Out of memory; measurement data overrun"
- 230, "Data corrupt or stale"
- 231, "Data questionable; requested sample timing not met"
- 240, "Hardware error; cannot communicate with measurement hardware"
- 240, "Hardware error; CPU board initialization failed"
- 240, "Hardware error; GPIB interface failed"
- 240, "Hardware error; measurement FPGA FIFO overflow"
- 240, "Hardware error; measurement hardware initialization failed"
- 241, "Hardware missing"
- 250, "Mass storage error: file read/write error"

- 250,"Mass storage error; internal file system could not be opened"
- 250,"Mass storage error; USB file system could not be opened"
- 253,"Corrupt media; file system corruption detected; reformat needed"
- 253,"Corrupt media; internal file system format failed"
- 253,"Corrupt media; internal file system scan failed"
- 253,"Corrupt media; USB file system scan failed"
- 256,"File name not found"
- 256,"File or folder name not found"
- 257,"File name error"
- 257,"File name error; access denied"
- 257,"File name error; drive name missing or not recognized"
- 257,"File name error; file or folder already exists"
- 257,"File name error; file too large"
- 257,"File name error; folder is default folder"
- 257,"File name error; folder not empty"
- 257,"File name error; invalid character in name"
- 257,"File name error; not a folder name"
- 257,"File name error; path is a folder name"
- 257,"File name error; path name missing"
- 257,"File name error; path too long"
- 257,"File name error; relative path not allowed"
- 257,"File name error; unknown file extension"
- 292,"Referenced name does not exist"

SCPI Programming Reference

Device-Specific Errors (-300...)

- 310, "System error"
- 310, "System error: slave processor aborted due to error"
- 310, "System error; internal software error"
- 310, "System error; out of memory"
- 310, "System error; software initialization failed"
- 313, "Calibration memory lost"
- 313, "Calibration memory lost; due to firmware revision change"
- 314, "Save/recall memory lost; due to firmware revision change"
- 314, "Save/recall memory lost; memory corruption detected"
- 315, "Configuration memory lost"
- 315, "Configuration memory lost; due to firmware revision change"
- 315, "Configuration memory lost; memory corruption detected"
- 350, "Queue overflow"

Query Errors (-400...)

- 400, "Query error"
- 410, "Query INTERRUPTED"
- 420, "Query UNTERMINATED"
- 430, "Query DEADLOCKED"
- 440, "Query UNTERMINATED after indefinite response"

Network Errors (+100...)

- +100, "Network Error"
- +110, "LXI mDNS Error"

Instrument Errors (+200...)

- +251, "Unsupported temperature transducer type"
- +263, "Not able to execute while instrument is measuring"
- +292, "State file size error"
- +293, "State file corrupt"
- +294, "Preference file size error"
- +295, "Preference file corrupt"

Miscellaneous Errors (+300... and +500..)

- +311, "Not able to specify resolution with Auto range"
- +320, "Slave processor communications error: boot message queue overflowed"
- +320, "Slave processor communications error: command returned error status"
- +320, "Slave processor communications error: communications restart failed"
- +320, "Slave processor communications error: communications restart succeeded"
- +320, "Slave processor communications error: data packet error detected"
- +320, "Slave processor communications error: read error detected"
- +320, "Slave processor communications error: write error detected"
- +514, "Not allowed; Instrument locked by another I/O session"
- +532, "Not able to achieve requested resolution"
- +540, "Cannot use overload as math reference"
- +541, "Cannot use zero as math reference for PCT scaling function"
- +542, "Measured dB reference too small"

Licensing and Self-test Errors (+600...)

- +600, "Internal licensing error"
- +601, "License file corrupt or empty"
- +602, "No valid licenses found for this instrument"
- +603, "Some licenses could not be installed"
- +604, "License not found"
- +605, "License already installed"
- +611, "Self-test failed; Real Time Clock reset, check battery"
- +612, "Self-test failed; keyboard processor not responding"
- +613, "Self-test failed; unable to communicate with power controller"
- +614, "Self-test failed; unable to sense line frequency"
- +615, "Self-test failed; measurement processor not responding"
- +616, "Self-test failed; calibration memory reading error"
- +617, "Self-test failed; FPGA unconfigured"
- +618, "Self-test failed; FPGA bus error"
- +619, "Self-test failed; FPGA clock"
- +620, "Self-test failed; shift register"
- +621, "Self-test failed; overload sense stuck on"
- +622, "Self-test failed; ADC generic error"
- +623, "Self-test failed; ADC integrator saturated"
- +624, "Self-test failed; Coarse ADC error"
- +625, "Self-test failed; ADC offset"
- +626, "Self-test failed; ADC noise"
- +627, "Self-test failed; Fine ADC generic error"
- +628, "Self-test failed; Fine ADC off-scale low"
- +629, "Self-test failed; Fine ADC off-scale high"
- +630, "Self-test failed; Fine ADC range"
- +631, "Self-test failed; Fine ADC bits stuck"
- +632, "Self-test failed; Fine ADC slope"
- +633, "Self-test failed; Fine ADC linearity"
- +634, "Self-test failed; low DC zero"

+635, "Self-test failed; high DC zero"
+636, "Self-test failed; +7V reference"
+637, "Self-test failed; -10V reference"
+638, "Self-test failed; x1 gain, zero input"
+639, "Self-test failed; x10 gain, zero input"
+640, "Self-test failed; x100 gain, zero input"
+641, "Self-test failed; precharge"
+642, "Self-test failed; x1 gain, non-zero input"
+643, "Self-test failed; x10 gain, non-zero input"
+644, "Self-test failed; x100 gain, non-zero input"
+645, "Self-test failed; 100uA current source"
+646, "Self-test failed; 10uA current source"
+647, "Self-test failed; 2 ohm shunt"
+648, "Self-test failed; AC offset"
+649, "Self-test failed; frequency input"
+650, "Self-test failed; input switch"
+651, "Self-test failed; autocal 10 V range full scale"
+652, "Self-test failed; autocal 10 V range tenth scale"
+653, "Self-test failed; autocal 1 V range full scale"
+654, "Self-test failed; autocal 1 V range tenth scale"
+655, "Self-test failed; autocal 100 mV range full scale"
+656, "Self-test failed; autocal 100 V range reference"
+657, "Self-test failed; autocal 10 kOhm range full scale"
+658, "Self-test failed; autocal 10 kOhm range tenth scale"
+659, "Self-test failed; autocal 1 kOhm range full scale"
+660, "Self-test failed; autocal 100 kOhm tenth scale"
+661, "Self-test failed; autocal 1 MOhm half scale"
+662, "Self-test failed; autocal 100 KOhm to 1 MOhm transfer"
+663, "Self-test failed; autocal 1 MOhm to 10 MOhm transfer"
+664, "Self-test failed; autocal 10 MOhm internal resistor"
+665, "Self-test aborted; high ac voltage present on input terminals"
+666, "Self-test aborted; high dc voltage present on input terminals"

Calibration Errors (+700...)

- +701, "Calibration error; security defeated"
- +702, "Calibration error; calibration memory is secured"
- +703, "Calibration error; secure code provided was invalid"
- +704, "Calibration error: secure code too long"
- +705, "Calibration error; calibration aborted"
- +706, "Calibration error: provided value out of range"
- +707, "Calibration error: computed correction factor out of range"
- +708, "Calibration error: signal measurement out of range"
- +708, "Calibration error; signal frequency out of range"
- +709, "Calibration error: no calibration for this function/range"
- +710, "Calibration error: full scale correction out of range"
- +711, "Calibration error: calibration string too long"
- +712, "Calibration failed"
- +713, "Calibration error; ADC calibration failed; ADC configuration 'ACI' did not converge"
- +713, "Calibration error; ADC calibration failed; ADC configuration 'ACV' did not converge"
- +713, "Calibration error; ADC calibration failed; ADC configuration 'DCV' did not converge"
- +713, "Calibration error; ADC calibration failed; DC offset for setup 'ACI'"
- +713, "Calibration error; ADC calibration failed; DC offset for setup 'ACV'"
- +713, "Calibration error; ADC calibration failed; DC offset for setup 'DCV'"
- +713, "Calibration error; ADC calibration failed; feedbackLutGainTune unsupported LUT goal"
- +713, "Calibration error; ADC calibration failed; feedbackLutTune search did not converge"
- +713, "Calibration error; ADC calibration failed; feedbackPiCancel did not converge for setup 'ACI'"
- +713, "Calibration error; ADC calibration failed; feedbackPiCancel did not converge for setup 'ACV'"
- +713, "Calibration error; ADC calibration failed; feedbackPiCancel did not converge for setup 'DCV'"
- +713, "Calibration error; ADC calibration failed; fine merge for setup 'ACI'"
- +713, "Calibration error; ADC calibration failed; fine merge for setup 'ACV'"
- +713, "Calibration error; ADC calibration failed; fine merge for setup 'DCV'"
- +713, "Calibration error; ADC calibration failed; fine offset for setup 'ACI'"
- +713, "Calibration error; ADC calibration failed; fine offset for setup 'ACV'"
- +713, "Calibration error; ADC calibration failed; fine offset for setup 'DCV'"

+713, "Calibration error; ADC calibration failed; fineDcCancel found non-monotonic value in setup 'ACI'"

+713, "Calibration error; ADC calibration failed; fineDcCancel found non-monotonic value in setup 'ACV'"

+713, "Calibration error; ADC calibration failed; fineDcCancel found non-monotonic value in setup 'DCV'"

+713, "Calibration error; ADC calibration failed; LUT gain for setup 'ACI'"

+713, "Calibration error; ADC calibration failed; LUT gain for setup 'ACV'"

+713, "Calibration error; ADC calibration failed; LUT gain for setup 'DCV'"

+713, "Calibration error; ADC calibration failed; LUT goal incompatible with ACV"

+713, "Calibration error; ADC calibration failed; PI offset for setup 'ACI'"

+713, "Calibration error; ADC calibration failed; PI offset for setup 'ACV'"

+713, "Calibration error; ADC calibration failed; PI offset for setup 'DCV'"

+713, "Calibration error; DCV 10M input impedance gain adjustment out of range"

+715, "Calibration error; must perform +100mV DCV calibration before -100mV"

+715, "Calibration error; must perform +100uA DCI calibration before -100uA"

+715, "Calibration error; must perform +10V DCV calibration before -10V"

+715, "Calibration error; must perform 10MOhm calibration before 100MOhm"

+720, "Calibration error; DCV offset out of range"

+721, "Calibration error; DCI offset out of range"

+722, "Calibration error; RES offset out of range"

+723, "Calibration error; FRES offset out of range"

+724, "Calibration error; extended resistance self cal failed"

+725, "Calibration error; 1000V DC correction out of range"

+726, "Calibration error; ACV offset out of range"

+727, "Calibration error; ACI offset out of range"

+730, "Calibration error; precharge DAC convergence failed"

+731, "Calibration error; A/D turnover correction out of range"

+732, "Calibration error; AC flatness calibration failed"

+733, "Calibration error; AC low frequency correction out of range"

+734, "Calibration error; AC flatness calibration restarted by function/range change"

+735, "Calibration error; 1 kHz AC flatness frequency point must be last frequency point in sequence"

+736, "Calibration error; DCI 100uA range self-cal failed"

+740, "Calibration data lost: secure state"

+740, "Calibration information lost; count, security state, security code, string"

SCPI Programming Reference

- +741, "Calibration data lost: string data"
- +742, "Calibration data lost: corrections"
- +746, "System information write failure"
- +747, "System information read failure"
- +748, "Calibration memory write failure"
- +749, "Calibration memory read failure"
- +750, "Autocalibration corrections lost; due to firmware revision change"
- +750, "Autocalibration corrections lost"
- +751, "Autocalibration memory write failure"
- +752, "Autocalibration memory read failure"
- +753, "Autocalibration measurement out of range"
- +760, "Operation aborted; high voltage present on input terminals"

Miscellaneous Errors (+800...)

- +800, "Nonvolatile memory write failure"
- +810, "State has not been stored"
- +820, "Model and serial numbers not restored"
- +821, "Controller and measurement board model numbers do not match"
- +822, "Controller and measurement board serial numbers do not match"
- +823, "Incorrect firmware loaded for this model number"

Power-On and Reset State

These tables show factory default settings. Parameters marked with a bullet (·) are nonvolatile and are not affected by power-on or system reset. Other parameters are volatile and are reset to the indicated values at power-on or after ***RST** or **SYSTem:PRESet**.

NOTE

The power-on/reset state may differ from these values if you have enabled power-on state recall mode.

Factory Default Settings

Measurement Configuration	Factory Setting
Function	DC Volts
Range	Autorange (for all functions)
Integration Time	NPLC On, 10 power line cycles (PLC)*
Resolution	Resolution equivalent to 10 PLC
Autozero	On*
Aperture (34465A/70A only)*	Off, 100 ms
Frequency or Period Aperture (Gate Time)	100 ms*
· Input Impedance	· 10 M Ω (fixed for all DC voltage ranges)
AC Input Filter (bandwidth)	20 Hz (medium filter)
Temperature Transducer Type	FRTD
RTD Reference Resistance	100 Ω
Nulls (individual functions)	Off; reference = 0.0, auto reference enabled (for all measurement functions)
Current Terminals	3 A
Secondary Measurements	Off
Screen Shot Format	PNG
Calibration Value	0.0
Current Switch Mode (34465A/70A only)	Continuous
Resistance (2- and 4-wire) (34465A/70A only):	
Offset Compensation	Off
Low Power Measurements	Off
Temperature (34465A/70A only):	
Offset Compensation (2- and 4- wire RTD)	Off
Low Power Measurements(2- and 4- wire RTD or thermistor)	Off
Thermocouple (34465A/70A only):	
Check	Off
Reference Junction Temperature, Type, Adjust	0° C, Internal, 0° C
Thermocouple Type	J
* For all DC measurement functions.	

SCPI Programming Reference

Math Operations	Factory Setting
Math State	Disabled
Scale Function	Null
Null and dB Relative Value	Set to 0.0 with auto reference enabled
Upper and Lower Limits	0.0
Histogram	Bin counts cleared; 100 bins; auto binning enabled
Statistics	Cleared
• dBm Reference Resistance	• 600 Ω
Calculate Scale (34465A/70A only):	
Gain	1.0
Offset	0.0
Reference	0.0
Unit State	Off
Unit	Null String
Calculate Smoothing (34465A/70A only):	
Response	Fast
State	Off

Triggering Operations	Factory Setting
Trigger Count	1
Trigger Source	Immediate
Trigger Delay	Auto Delay
Sample Count	1
Trigger Slope	Negative
VM Comp Output Slope	NEG
Pretrigger Count (34465A/70A only)	0
Triggering (34465A/70A only):	
Sample Source	Immediate
Sample Timer	1 s
Trigger Level	0.0

System-Related Operations	Factory Setting
• Beeper Mode	• On
• Thousands Separator	• On
Display State	On
Reading Memory	Cleared
Error Queue	See note
• Stored States	• No Change
• Calibration State	• Secured

Data Settings	Factory Setting
Binary Block Data Format (34465A/70A only):	
Border	Normal
Data	ASCII, 9
Data Transfer (34465A/70A only):	
Separator	Comma
Header	Off
Reading Limits	Off

NOTE

The Error Queue is cleared at power on. It is not cleared by ***RST**, **SYSTem:PRESet**, or a front panel Preset.

Input/Output Configuration	Factory Setting
Enable Interfaces:¹	
• LAN	• Enabled
• GPIB	• Enabled
• USB	• Enabled
LAN Settings:²	
• DHCP	• On
• Auto IP	• On
• IP Address	• 169.254.4.60 (for 34460A) • 169.254.4.61 (for 34461A) • 169.254.4.65 (for 34465A) • 169.254.4.70 (for 34470A)
• Subnet Mask	• 255.255.0.0
• Default Gateway	• 0.0.0.0
• DNS Server	• 0.0.0.0
• Host Name	• K-34460A- <i>nnnnn</i> (for 34460A) ³ • K-34461A- <i>nnnnn</i> (for 34461A) • K-34465A- <i>nnnnn</i> (for 34465A) • K-34470A- <i>nnnnn</i> (for 34470A)
• LAN Services ¹	• Enable All (<i>VISA LAN, Sockets, Telnet, Web Server, mDNS, HiSLIP</i>)
GPIB Settings:	
• GPIB Address	• 22
<p>¹ Interface enable or LAN service changes take effect only after you cycle power. ² LAN setting changes require a LAN restart. From SCPI you must cycle power. ³ Where <i>nnnnn</i> represents the last 5 digits of the instrument serial number.</p>	

NOTE

The instrument uses LAN port 5024 for SCPI Telnet sessions and port 5025 for SCPI Socket sessions.

Service and Repair

This section contains basic instrument service information.

[Types of Service Available](#)

[Cleaning](#)

[Electrostatic Discharge \(ESD\) Precautions](#)

Additional service information is found here:

[Power Supplies](#)

[Troubleshooting](#)

[Self-Test Procedures](#)

[User Replaceable Parts](#)

[Disassembly](#)

[Battery Replacement](#)

[3 A and 10 A Current Path Fuse Replacement](#)

[Installing the Optional GPIB Interface](#)

Types of Service Available

If your instrument fails during the warranty period, Keysight Technologies will repair or replace it under the terms of your warranty. After your warranty expires, Keysight offers repair services at competitive prices. You also have the option to purchase a service contract that extends coverage after the standard warranty expires.

Obtaining Repair Service (Worldwide)

To obtain service for your instrument, [contact your nearest Keysight Technologies Service Center](#). They will arrange to have your unit repaired or replaced, and can provide warranty or repair-cost information where applicable. Ask the Keysight Technologies Service Center for shipping instructions, including what components to ship. Keysight recommends that you retain the original shipping carton for return shipments.

Repackaging for Shipment

To ship the unit to Keysight for service or repair:

- Attach a tag to the unit identifying the owner and indicating the required service or repair. Include the model number and full serial number.
- Place the unit in its original container with appropriate packaging material.
- Secure the container with strong tape or metal bands.
- If the original shipping container is unavailable, use a container that will ensure at least 10 cm (4 in.) of compressible packaging material around the entire instrument. Use static-free packaging materials.

Keysight suggests that you always insure shipments.

Cleaning

To prevent electrical shock, disconnect the instrument from AC mains power and disconnect all test leads before cleaning. Clean the outside of the instrument using a soft, lint-free, cloth slightly dampened with water.

Do not use detergent or solvents.

Do not attempt to clean internally.

If needed, contact a Keysight Technologies Sales and Service office to arrange for proper cleaning to ensure that safety features and performance are maintained.

Electrostatic Discharge (ESD) Precautions

Almost all electrical components can be damaged by electrostatic discharge (ESD) during handling. Component damage can occur at electrostatic discharge voltages as low as 50 V.

The following guidelines will help prevent ESD damage during service operations:

- Disassemble instruments only in a static-free work area.
- Use a conductive work area to reduce static charges.
- Use a conductive wrist strap to reduce static charge accumulation.
- Minimize handling.
- Keep replacement parts in original static-free packaging.
- Remove all plastic, foam, vinyl, paper, and other static-generating materials from the immediate work area.

Power Supplies

The following procedure allows you to determine whether the power supplies are working properly.

WARNING Follow the [disassembly procedure](#) to disassemble the instrument. Be sure to disconnect all inputs to the instrument before beginning disassembly.

Circuit side of board

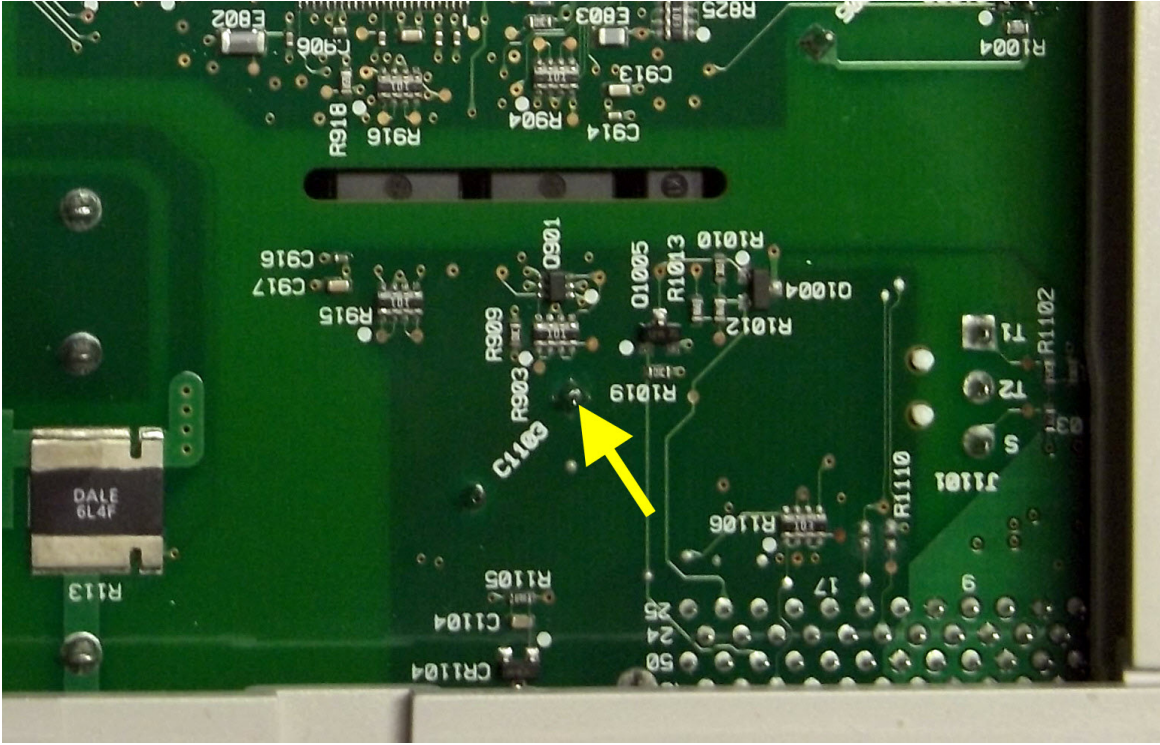

The following measurements use the frame of the instrument as the low voltage reference. For the following measurements, the instrument should be turned on, and the light below the power switch should be green.

Pin	Location Detail
C1103 pin 1 15 V ± 25%	

Component side of board

For the following measurements, the instrument should be turned on, and the light below the power switch should be green.

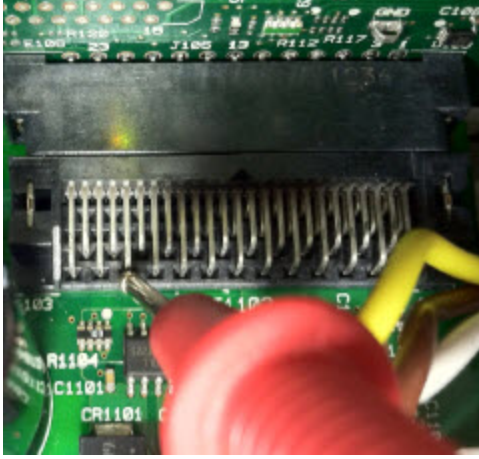
Refer to the detailed images in the table below for exact location information.

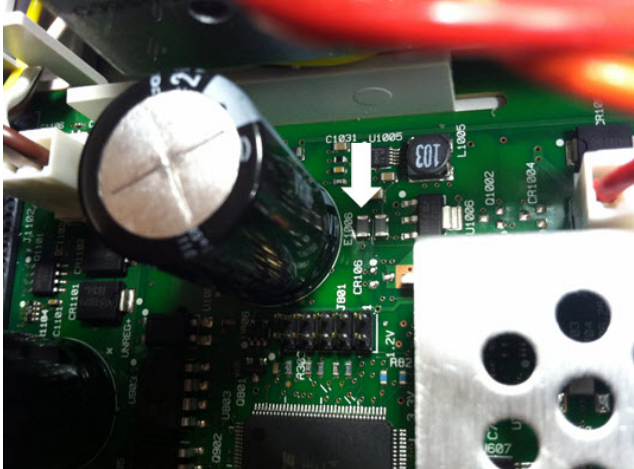
Pin	Location Detail
<p>Low reference: chassis</p> <p>J1102 pin 21:</p> <p>3.3 V ± 5%</p>	
<p>Low reference: large metal shield</p> <p>R1020 (either side of component):</p> <p>10 V ± 20%</p>	
<p>Low reference: large metal shield</p> <p>E1006 (either side of component):</p> <p>3.3 V ± 5%</p>	

Service and Repair

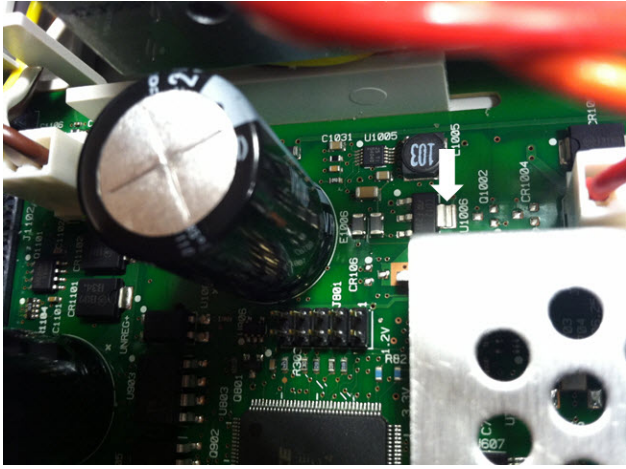
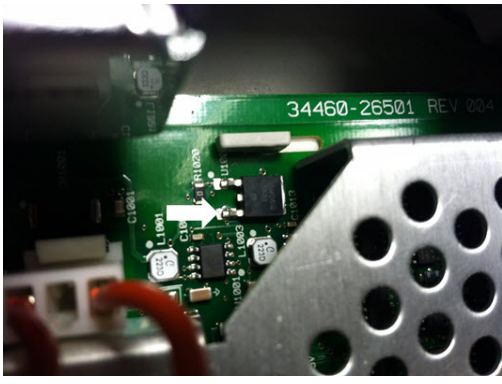
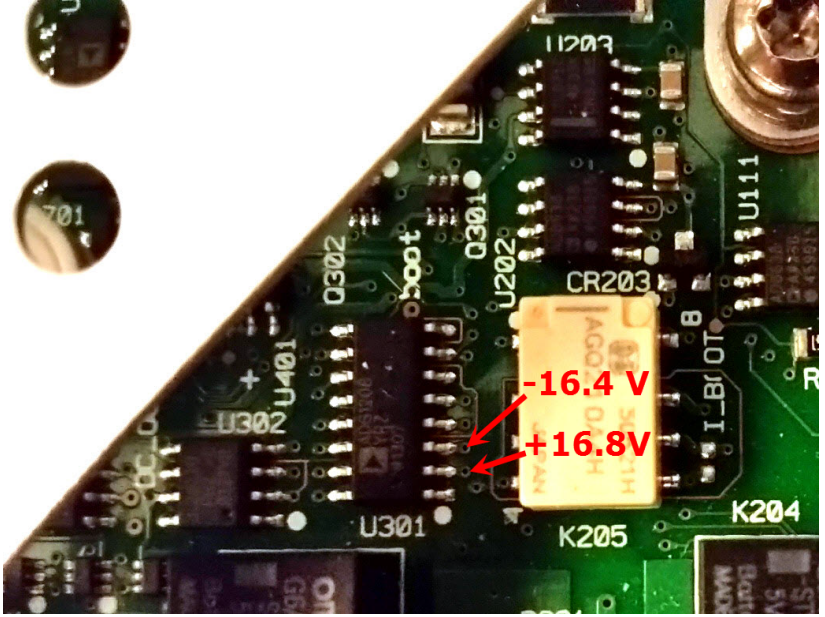
Pin	Location Detail
<p>Low reference: large metal shield</p> <p>U1006 (large tab on right side as shown in picture):</p> <p>1.2 V ± 5%</p>	
<p>Low reference: large metal shield</p> <p>U1004 pin 3:</p> <p>5 V ± 5%</p>	
<p>Low reference: large metal shield</p> <p>U301:</p> <p>pin 2: +16.8 V ± 5%</p> <p>pin 3: -16.4 V ± 5%</p>	

Troubleshooting

Before troubleshooting or repairing the instrument, make sure the failure is in the instrument rather than any external connections. Also make sure that the instrument was accurately calibrated within the last year (see [Calibration Interval](#)). The instrument's circuits allow troubleshooting and repair with basic test equipment.

CAUTION

DO NOT swap the motherboard or the front panel board from one instrument to another. These boards contain model number and serial number information that uniquely identifies a specific unit, and boards that are mismatched to the instrument may result in problems with its performance, licensing, serviceability, importability/exportability or warranty.

Troubleshooting Procedure

1. Remove all remote I/O connections and front panel connections to the instrument. Verify that:
 - a. the AC mains power cord is securely connected to the instrument and plugged into a live outlet
 - b. the front panel Power On/Standby switch has been pushed
2. If the standby light below the power switch is not illuminated, re-verify the items above. If all this is correct, check the AC mains power and then the internal line fuse.
3. If the standby light is on (yellow or green), press the power button. If there is no response, replace the front panel board because the power button on the front panel board is likely broken.
4. **Check the voltages on the power supply.** If one or more of these tests fail, disconnect the transformer secondaries from the main board and measure the voltages from the transformer with an AC voltmeter.

The voltage between the red and orange wires (below) should measure 7.5 to 11 VAC.

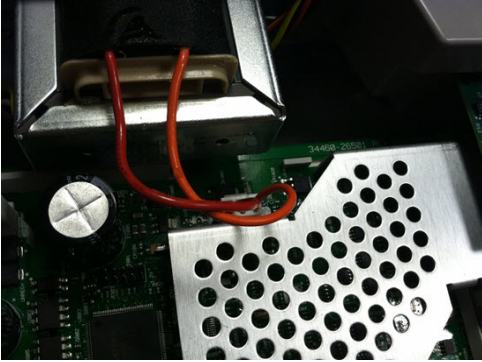

The voltage between the brown and white wires (below) should measure 11 to 15 VAC.

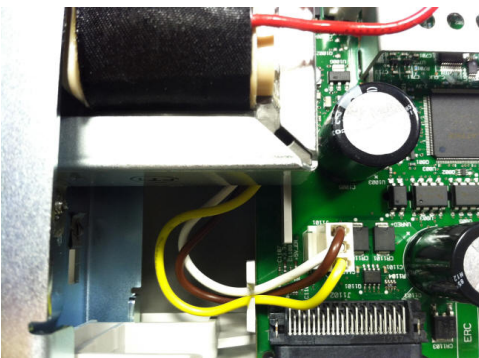

5. If the voltages are correct, replace the main board; otherwise replace the transformer.

6. Turn the instrument on. If the power-on sequence completes and the display appears to function properly, verify that the instrument is in local mode (the Remote annunciator in the upper right corner of the display is not on), and run the full self-test ([Utility] > Test/Admin > Self-Test > Full Test). If the display is illegible, replace the front panel board.

CAUTION

Ensure that all connections (front and rear) are removed when self-test is performed. During self-test, errors may be induced by signals present on external wiring, such as long test leads that can act as antennas.

7. If the self test generates an error, record the error code and message and contact Keysight support if necessary.
8. If the self test does not generate an error:
 - a. If remote I/O on GPIB (optional) is not working, replace the GPIB board.
 - b. If the measurements are out of specification, you may wish to calibrate the instrument before deciding to replace the main board.
 - c. If the front panel buttons are not working, make sure the unit is in local mode (the Remote annunciator in the upper right corner of the display is not displayed). If that does not solve the problem, replace the front panel board.
 - d. If the display is dim, [adjust the display intensity](#).
9. If the instrument does not complete the power-on sequence, check the signal frequency at test point TP200 on the front panel board and verify that it is $29.8 \text{ kHz} \pm 500 \text{ Hz}$. If the frequency is not correct, replace the front panel board.

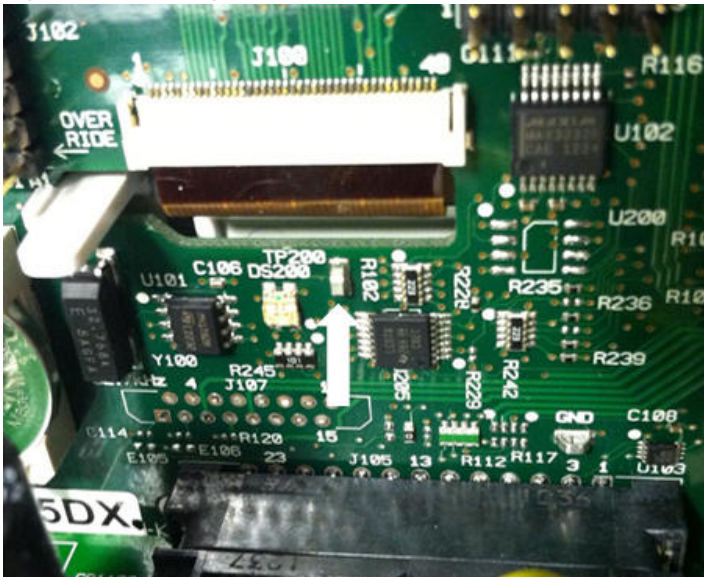

Service and Repair

10. Also verify that the voltage is $3.3\text{ V} \pm 5\%$ at resistor R121, referenced to the instrument chassis. If this voltage is incorrect, replace the front panel board.

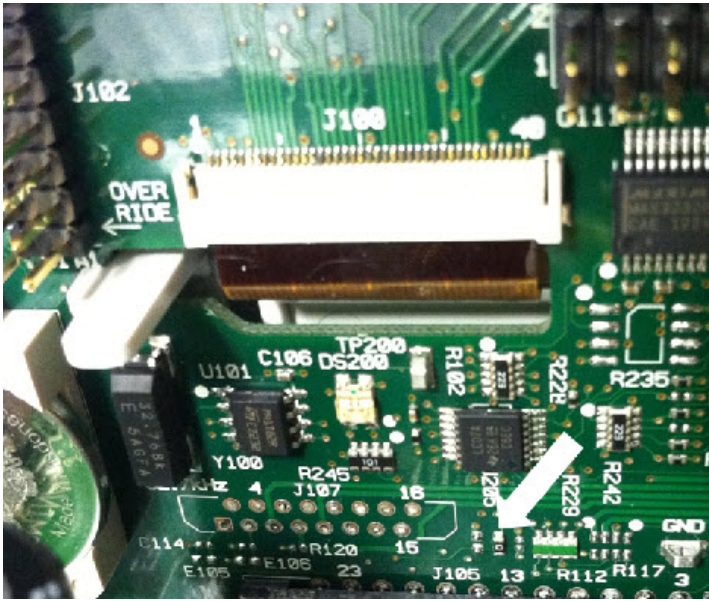

Self-Test Procedures

Power-On Self-Test

Each time the instrument is powered on, it performs a self-test on its real-time clock, keyboard processor, power controller, measurement processor, calibration memory, FPGA, ADC, gain and offset circuitry, and voltage references. This self-test is equivalent to the *TST? SCPI query, and you do not need to remove inputs to the instrument to run the test.

Full Self-Test

A complete self-test ([TEST:ALL?](#)) takes approximately two seconds. This tests all of the items tested by the power-on self-test and includes further tests for gain, current source, and shunt circuitry.

When self-test completes, either "Self-test Passed" or "Self-test Failed" appears on front panel.

Execute the complete self-test before performing any verification or calibration procedures.

CAUTION You must remove all input connections to the instrument before running the full self-test.

Remote I/O Execution

1. Connect to the instrument using the remote interface ([Remote Interface Configuration](#)).
2. Send [*TST?](#) or [TEST:ALL?](#) and read the result: pass (+0) or fail (+1). Use [SYSTEM:ERRor?](#) to view errors. See the [list of self-test errors](#) for details.

Front Panel Execution

1. Press **[Shift]** > **[Utility]** > **Test/Admin** > **Self Test**.
2. View any failures by pressing **[Shift]** > **[Help]** > **View remote command error queue**.

User Replaceable Parts

Replacement parts for the instrument are listed below. Unless otherwise shown, all parts apply to all Truevolt models.

Part Number	Description
34401-86020	Bumper Kit
33220-88304	Rear Bezel
34401-45021	Handle
33220-84101	Cover
5041-5228	Keypad
2090-1051	Display
2110-0817	Line Fuse (250 mA, 250 V, time delay)
2110-1547	Current Protection Fuse (3.15 A, 500 V, time delay)
2110-1402	Internal Fuse (11 A, 1000 V, fast acting)
34460-87910	Transformer
34401-45012	Terminal Latch
5041-5238	Power Module
34460-40201	Plastic Front Panel (34460A)
34461-40201	Plastic Front Panel (34461A)
34465-40201	Plastic Front Panel (34465A)
34470-40201	Plastic Front Panel (34470A)
53200-49311	Window
5041-5231	Front Panel Shield
5041-5225	Front/Rear Push Rod (34461A, 34465A, 34470A)
5041-5232	Fan (34461A, 34465A, 34470A)
5041-5261	Fan Shield (34465A, 34470A)
5041-5257	Cable Assembly, Thermistor (34465A, 34470A)
1420-0356	Battery (in front panel)
34470-66303	Reference Assembly

Disassembly

This section describes the procedure for disassembling the instrument.

WARNING

Only qualified, service-trained personnel who are aware of the hazards involved should remove instrument covers. Always disconnect the power cable and any external circuits before removing the instrument cover. Some circuits are active and have power applied even when the power switch is turned off.

Always disconnect all inputs, cords, and cables before disassembling the instrument.

CAUTION

Do not turn the screw that fastens the shield in place, as this will affect the instrument's calibration.



Tools Required

The following tools are required.

- T20 Torx driver (most disassembly)
- Small, flat-blade screw driver (for prying)

General Disassembly Procedure

1. Turn off the power and remove all measurement leads and other cables, including the power cord, from the instrument before continuing.
2. Rotate the handle to the upright position and remove it by pulling outward where it attaches to the case.



3. Pull off the front rubber bumper.
4. Unscrew the two captive screws in the rear bezel and remove the rear bezel and rubber bumper.



5. Remove the screw on the bottom of the instrument and place it in a safe location for re-assembly. Slide off the instrument cover.

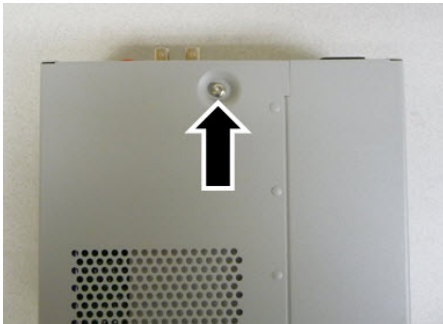

NOTE

At this point, the instrument is sufficiently disassembled for power supply troubleshooting purposes. You could also change the battery or [override calibration security](#) at this point. If you need to disassemble the front panel, continue with the steps shown below.

6. Use the small, flat-blade screwdriver to pry the black latch up and remove it. Note the orientation of the latch for re-assembly purposes.

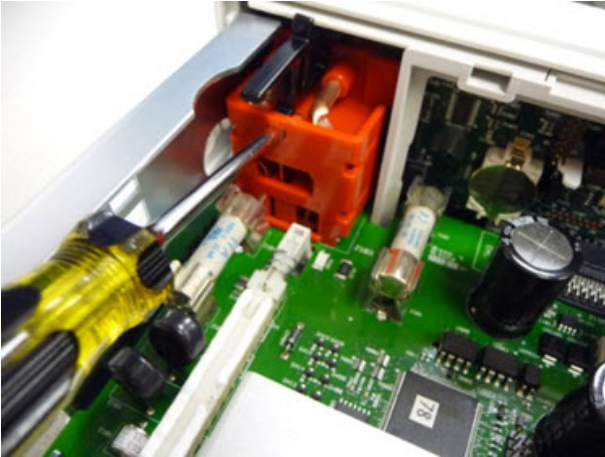

7. Push in on the lever shown, and squeeze the metal frame of the instrument to release the front panel plastic.

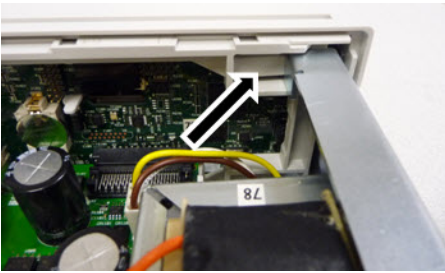

8. Slide the front panel off.
9. Slide the white plastic backing plate to the right and lift up on the left side of the backing plate to remove it.

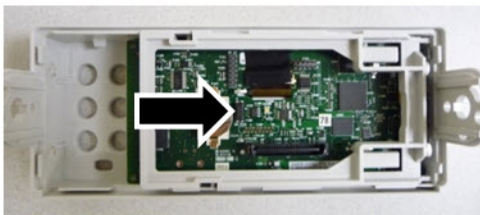

10. Remove the front panel PCBA by holding the connector housing shown below and lifting it out.



Service and Repair

11. Remove the ESD shield by prying it out gently from the plastic housing to which it attaches.

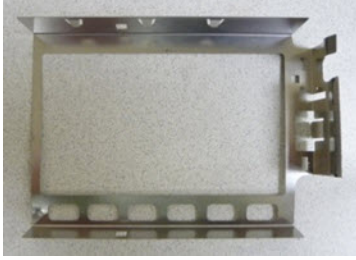

This concludes the disassembly procedure. To re-assemble the instrument, reverse the procedure.

Battery Replacement

This section describes the procedure for replacing the battery on the instrument's front panel.

WARNING

Only qualified, service-trained personnel who are aware of the hazards involved should remove instrument covers. Always disconnect the power cable and any external circuits before removing the instrument cover. Some circuits are active and have power applied even when the power switch is turned off.

Always disconnect all inputs, cords, and cables before disassembling the instrument.

Tools Required

- T20 Torx driver (most disassembly)
- Small, flat-blade screw driver (for prying)

Procedure

(Images shown below provided courtesy of Keystone Electronics Corp.)

1. Turn off the power and remove all measurement leads and other cables, including the power cord, from the instrument before continuing.
2. Follow the [disassembly procedure](#) to disassemble the instrument.
3. Locate the battery on the front panel, and position the screwdriver tip under the battery, as shown.

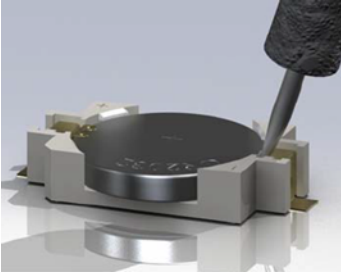

4. Use the screwdriver to pry the battery from the battery holder.

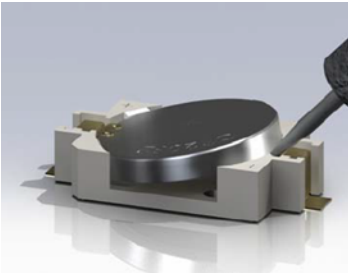

5. Remove the battery and discard or recycle it in accordance with all applicable regulations.
6. Position the new battery in the battery holder, + side up. Push down gently to seat the battery in the holder.

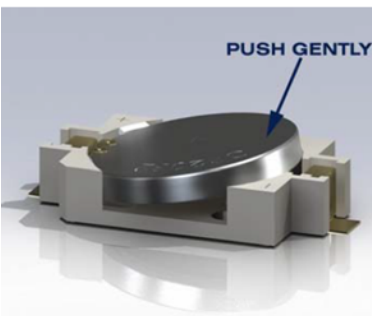

7. Re-assemble the instrument completely before connecting any cables or cords.

This concludes the battery replacement procedure.

3 A and 10 A Current Path Fuse Replacement

This section describes the procedure for testing and replacing the 3 A and 10 A current path fuses inside the instrument.

WARNING

Only qualified, service-trained personnel who are aware of the hazards involved should remove instrument covers. Always disconnect the power cable and any external circuits before removing the instrument cover. Some circuits are active and have power applied even when the power switch is turned off.

Always disconnect all inputs, cords, and cables before disassembling the instrument.

CAUTION

Do not turn the screw that fastens the shield in place, as this will affect the instrument's calibration.



Tools Required

- T20 Torx driver (most disassembly)
- Small, flat-blade screw driver (for prying)

Testing the Fuses

3 A Current Path

To determine whether the instrument's 3 A current path has a fuse that must be replaced, press [**Cont**] to put the DMM in continuity measurement mode, and short the HI Input terminal to the 3 A current terminal. If the measurement displays OPEN, one of the two fuses must be replaced. One fuse is accessible from the instrument's rear panel; the other is internal.

If the 3 A current path has a bad fuse, it is very likely to be the fuse accessible from the lower left corner of the instrument's rear panel (part number 2110-1547, 3.15 A, 500 V, time delay). Simply use a flat-blade screw driver to turn the fuse holder counter-clockwise and access the fuse. Put the new fuse into the fuse holder and insert the assembly back into the instrument, turning the fuse holder clockwise to lock it in place.

If the 3 A path still has a bad fuse, replace the internal 3 A current path fuse as described below.

10 A Current Path (34461A/65A/70A only)

To determine whether the instrument's 10 A current path has a fuse that must be replaced, press [**Cont**] to put the DMM in continuity measurement mode, and short the HI Input terminal to the 10 A current terminal. If the measurement displays OPEN, replace the internal 10 A current path fuse as described below.

Internal Fuse Replacement Procedure

Both internal current path fuses are part number 2110-1402, 11 A, 1000 V, fast acting. To replace an internal fuse:

1. Turn off the power and remove all measurement leads and other cables, including the power cord, from the instrument before continuing.
2. Follow the [disassembly procedure](#) to disassemble the instrument.
3. Locate the fuse to be replaced, as shown below.

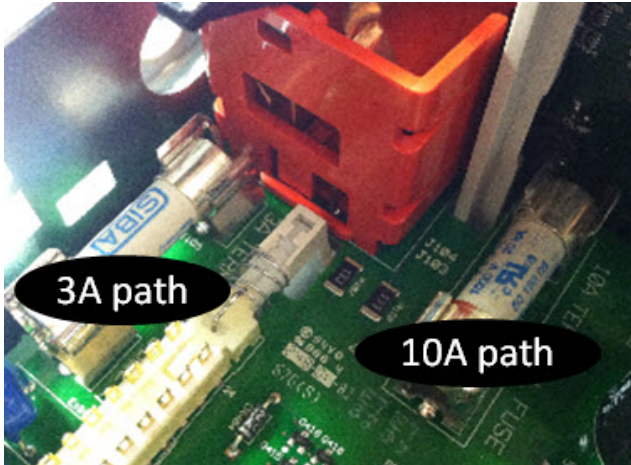

4. Use the screwdriver to pry the fuse from the fuse holder, being careful not to damage the circuit board. For the 3 A fuse, it may be easiest to access the fuse from the side, through the rectangular aperture in the sheet metal.
5. Remove the fuse.
6. Position the new fuse in the fuse holder. Push down gently to seat the fuse in the holder.
7. Re-assemble the instrument completely before connecting any cables or cords.

This concludes the fuse replacement procedure.

Installing the Optional GPIB Interface

WARNING This procedure should be performed by qualified service personnel only. Turn off the power and remove all measurement leads and other cables, including the power cord, from the instrument before continuing.

Tools Required

The following tools are required.

- T10 Torx driver

Installation Procedure

Turn off the power and remove all measurement leads and other cables, including the power cord, from the instrument before continuing.

Use the Torx driver to remove the screw from the GPIB cover plate. Retain the screw for use later in this procedure. Then remove the cover plate by sliding it to the left.

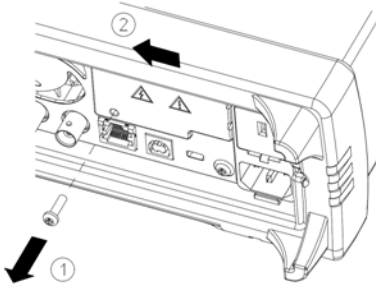

WARNING Retain GPIB Cover Plate

After installing the GPIB option, retain the cover plate for use in the event that you ever remove the GPIB option. The instrument should never be connected to power or inputs on the measurement terminals without either the GPIB module or the cover plate securely covering the rear-panel opening.

Locate the connector, just inside the unit, for the cable attached to the GPIB module

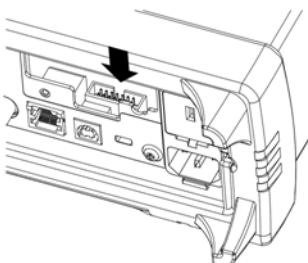

Bend the cable so that it extends above the circuit board. Attach the cable to the connector that was located in the previous step.

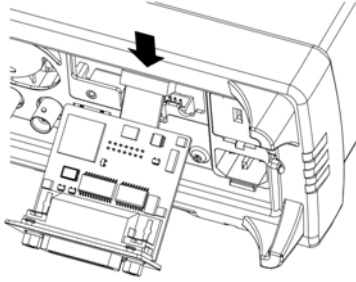

Put the module into the unit and slide the GPIB board to the right so that it is flush against the instrument's sheet metal. Use the screw that was removed above to secure the GPIB plate in place.

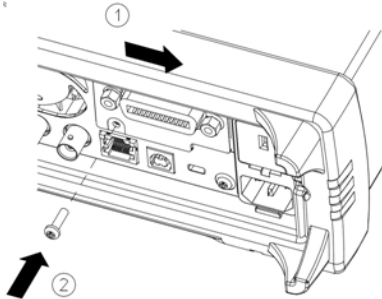

This concludes the GPIB installation procedure.

Security Code Override

The instrument security code is set to AT3446XA at the factory. If it has been changed and you no longer remember the code, you can reset the code back to its factory default value by using one of the two following procedures.

Which Procedure Should I Use?

From the instrument front panel, press **[Shift]** > **[Help]** > **About** to view the instrument firmware revision. An example display is:

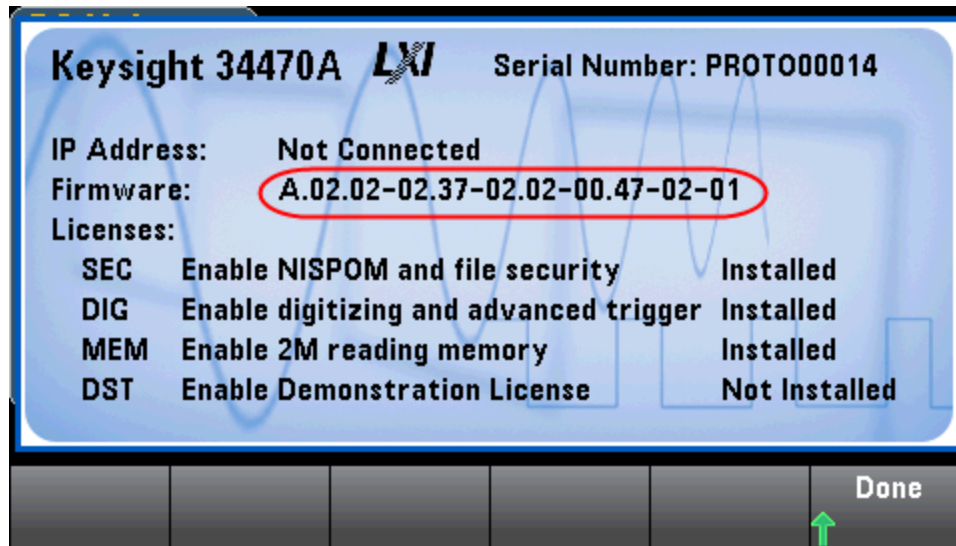

The last two digits of the firmware revision indicate the front panel PC board revision and which of the two procedures you should use. If the firmware revision ends with 02 or greater, use [Procedure A](#). If the firmware revision ends with 01, use [Procedure B](#).



If you encounter problems, contact Keysight Technologies for technical support.

In the United States: (800) 829-4444

In Europe: 31 20 547 2111

In Japan: 0120-421-345

Use www.keysight.com/find/assist to contact Keysight worldwide, or contact your Keysight Technologies representative.

Procedure A: For Firmware Revision Ending in 02, or Greater

WARNING

This procedure should be performed by qualified service personnel only. Turn off the power and remove all measurement leads and other cables, including the power cord, from the instrument before continuing.

1. Follow the [disassembly procedure](#) to disassemble the instrument.
2. Locate connector J102 on the front panel board. Short pin A1 to B1 as shown by the orange line below.

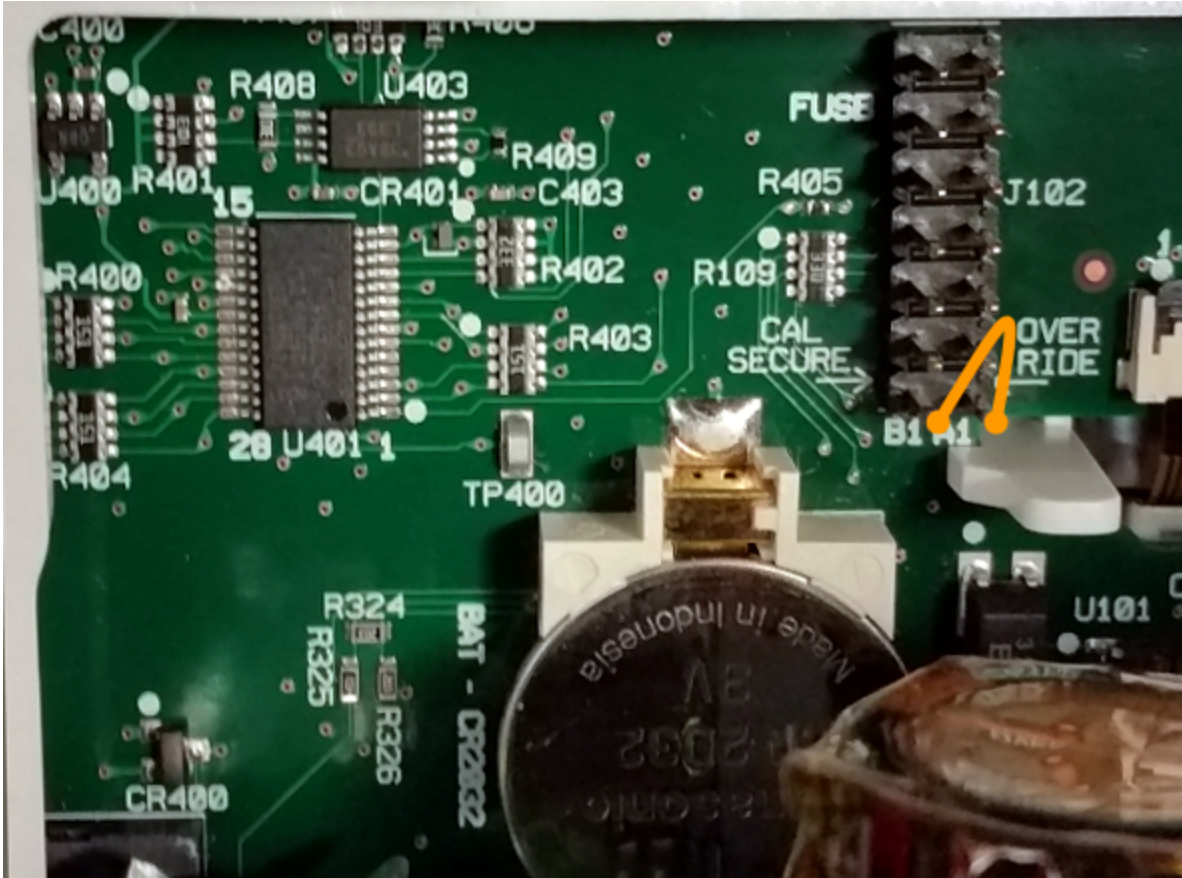

3. Reassemble the instrument, apply power and turn it on; the instrument will generate an error and beep (this is normal). Wait 30 to 40 seconds for the instrument to power up completely.
4. Reset the security code to the factory default:
 - a. Press **[Shift]** > **[Utility]** > **Test / Admin** > **Security** > **New Code**.
 - b. Enter AT3446XA as the new passcode.
 - c. Press **Done**.
 - d. Verify the new code and press **Yes** to confirm the change.

Service and Repair

5. Remove power, disassemble the instrument, and remove the short. Then reassemble the instrument to complete the security code reset procedure.

Procedure B: For Firmware Revision Ending in 01

WARNING This procedure should be performed by qualified service personnel only. Turn off the power and remove all measurement leads and other cables, including the power cord, from the instrument before continuing.

1. Follow the [disassembly procedure](#) to disassemble the instrument.
2. Locate connector J102 on the front panel board. Short pin A1 to A6 or A7 as shown by the orange lines below. You do not need to short both pins to A1, just one of them.

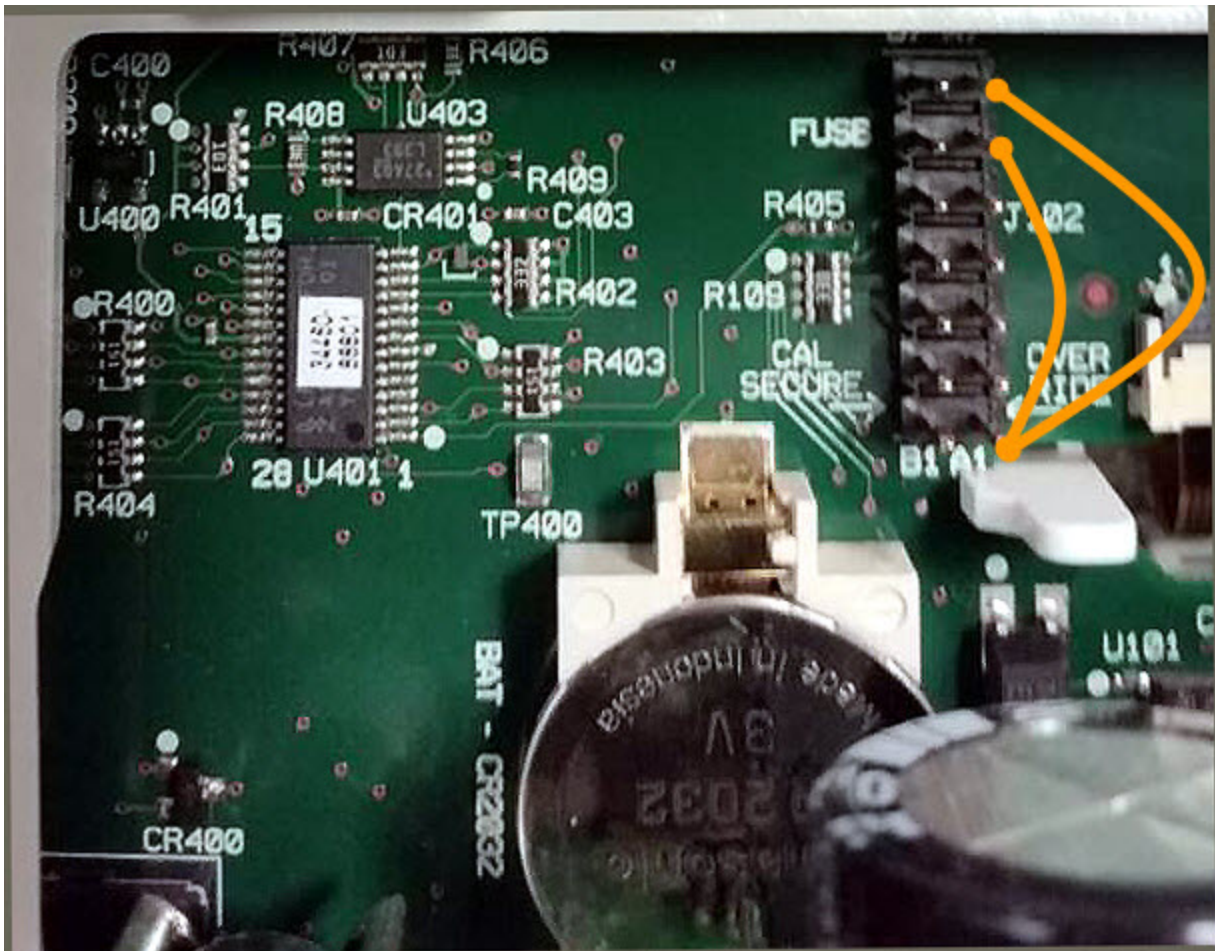

3. Reassemble the instrument, apply power and turn it on; the instrument will generate an error and beep (this is normal). Wait 30 to 40 seconds for the instrument to power up completely.

Performance Verification

4. Reset the security code to the factory default:
 - a. Press **[Shift]** > **[Utility]** > **Test / Admin** > **Security** > **New Code**.
 - b. Enter AT3446XA as the new passcode.
 - c. Press **Done**.
 - d. Verify the new code and press **Yes** to confirm the change.
5. Remove power, disassemble the instrument, and remove the short. Then reassemble the instrument to complete the security code reset procedure.

Performance Verification

Use the performance verification tests in this section to verify the measurement performance of the instrument using the instrument's specifications listed in the product data sheet.

You can perform three different levels of performance verification tests:

- **Self-Test (two types):** Internal verification tests that give a high confidence that the instrument is operational, as described [here](#).
- **Quick Verification:** A combination of the internal self-tests and selected verification tests.
- **Performance Verification Tests:** An extensive set of tests that are recommended as an acceptance test when you first receive the instrument or after performing calibration:
 - [Zero Offset Verification](#)
 - [DC Volts and DC Current Gain Verification](#)
 - [Frequency Accuracy Verification](#)
 - [AC Voltage and AC Current Verification](#)
 - [High Current Verification](#)
 - [Capacitance Verification \(Optional Verification Test\)](#)

Quick Performance Check

The quick performance check is a combination of internal self-test and an abbreviated performance test (specified by the letter Q in the performance verification tests). This provides a simple method to achieve high confidence in the instrument's ability to functionally operate and meet specifications. These tests represent the absolute minimum set of performance checks recommended following any service activity. Auditing the instrument's performance for the quick check points (designated by a Q) verifies performance for "normal" accuracy drift mechanisms. This test does not check for abnormal component failures.

To perform the quick performance check, do the following:

- Perform a [self-test](#).
- Perform only the performance verification tests indicated with the letter **Q**.

If the instrument fails the quick performance check, calibration or repair is required.

The Quick Performance Check can be limited by the factors described in the following section (*Performance Verification Tests*).

Performance Verification Tests

The performance verification tests are recommended as acceptance tests when you first receive the instrument. The acceptance test results should be compared against the 90 day test limits. You should use the 24 hour test limits only for verification within 24 hours after performing the calibration adjustment procedure.

If a Fluke 5725A Calibrator is not available, current verification can be limited to 2A. This will limit the span of verification on the 10A ranges to only 2A.

If the instrument fails performance verification, calibration adjustment or repair is required.

To reset the date used to determine the specifications versus time, a calibration with adjustment is required.

The allowable errors for verification are the published specifications (see the instrument data sheet at www.keysight.com/find/truevolt-doc). The periods in the published specifications are since the last full calibration adjustment.

Recommended Test Equipment

The recommended test equipment for the performance verification and calibration is listed below. If the exact instrument is not available, substitute calibration standards of equivalent accuracy.

An alternate method is to use the Keysight 3458A 8½-digit Digital Multimeter to measure less accurate, yet stable, sources. The output value measured from the source can be entered into the instrument as the target calibration value.

Application	Recommended Equipment
Zero Calibration	Keysight 34172B
DC Voltage	Fluke 5720A
DC Current	Fluke 5720A
Resistance	Fluke 5720A
AC Voltage	Fluke 5720A
AC Current	Fluke 5720A
Frequency	Keysight 33500B Series Function/Arbitrary Waveform Generator
High Current	Fluke 5725A
Capacitance (Optional)	SCA-1uF Capacitance Standard

Zero Offset Verification

This procedure checks the instrument's zero offset performance. Verification checks are only performed for those functions and ranges with unique offset calibration constants. Measurements are checked for each function and range as described below.

1. Make sure you have read [Test Considerations](#).
2. Install the 34172B Calibration Short (or equivalent) on the front panel input terminals. Select the Front input terminals with the Front/Rear switch.
3. Configure each function and range in the order shown in the table below corresponding to the DMM model number. Make a measurement and return the result. Compare measurement results to the test limits shown below.
4. Install the 34172B Calibration Short (or equivalent) on the rear-panel input terminals. Select the Rear input terminals with the Front/Rear switch.
5. Configure each function and range in the order shown in the table below corresponding to the DMM model number. Make a measurement and return the result. Compare measurement results to the test limits shown below.

Values for 34460A DMM							
Input	Function ^[1]	Range	Quick Check	Error from Nominal			
				24 hours	90 days	1 year	2 years
Open	DC Current	100 μ A	Q	$\pm 0.02 \mu$ A	$\pm 0.025 \mu$ A		
		1 mA		$\pm 0.060 \mu$ A			
		10 mA		$\pm 2 \mu$ A			
		100 mA		$\pm 4 \mu$ A	$\pm 5 \mu$ A		
		1 A		$\pm 60 \mu$ A	$\pm 100 \mu$ A		
		3 A		$\pm 600 \mu$ A			
Short	DC Volts	100 mV	Q	$\pm 6 \mu$ V	$\pm 6.5 \mu$ V		
		1 V		$\pm 9 \mu$ V	$\pm 10 \mu$ V		
		10 V		$\pm 40 \mu$ V	$\pm 50 \mu$ V		
		100 V		$\pm 600 \mu$ V			
		1000 V		± 6 mV	± 10 mV		
Short	4-wire Ohms	100 Ω		± 6 m Ω	± 7 m Ω		
		1 k Ω		± 8 m Ω	± 10 m Ω		
		10 k Ω	Q	± 50 m Ω	± 100 m Ω		
		100 k Ω		± 500 m Ω	$\pm 1 \Omega$		
		1 M Ω		$\pm 10 \Omega$			
		10 M Ω		$\pm 100 \Omega$			

^[1]Select 10 PLC.

Q: Quick performance verification test point.

Performance Verification

Values for 34461A DMM							
Input	Function ^[1]	Range	Quick Check	Error from Nominal			
				24 hours	90 days	1 year	2 years
Open	DC Current	100 μ A	Q	$\pm 0.02 \mu$ A	$\pm 0.025 \mu$ A		
		1 mA		$\pm 0.060 \mu$ A			
		10 mA		$\pm 2 \mu$ A			
		100 mA		$\pm 4 \mu$ A	$\pm 5 \mu$ A		
		1 A		$\pm 60 \mu$ A	$\pm 100 \mu$ A		
		3 A		$\pm 600 \mu$ A			
		10 A		± 1 mA			
Short	DC Volts	100 mV	Q	$\pm 3 \mu$ V	$\pm 3.5 \mu$ V		
		1 V		$\pm 6 \mu$ V	$\pm 7 \mu$ V		
		10 V		$\pm 40 \mu$ V	$\pm 50 \mu$ V		
		100 V		$\pm 600 \mu$ V			
		1000 V		± 6 mV	± 10 mV		
Short	4-wire Ohms	100 Ω		± 3 m Ω	± 4 m Ω		
		1 k Ω		± 5 m Ω	± 10 m Ω		
		10 k Ω	Q	± 50 m Ω	± 100 m Ω		
		100 k Ω		± 500 m Ω	$\pm 1 \Omega$		
		1 M Ω		$\pm 10 \Omega$			
		10 M Ω		$\pm 100 \Omega$			

^[1]Select 10 PLC.

Q: Quick performance verification test point.

Values for 34465A DMM							
Input	Function ^[1]	Range	Quick Check	Error from Nominal			
				24 hours	90 days	1 year	2 years
Open	DC Current	1 μ A		± 50 pA (50E-12 A) ^[2]			
		10 μ A		± 200 pA (± 200.0 E-12 A) ^[2]			
		100 μ A	Q	± 0.001 μ A ^[2]			
		1 mA		± 0.030 μ A	± 0.050 μ A		
		10 mA		± 2 μ A			
		100 mA		± 4 μ A	± 5 μ A		
		1 A		± 60 μ A	± 100 μ A		
		3 A		± 600 μ A			
		10 A		± 1 ma			
Short	DC Volts	100 mV	Q	± 3 μ V	± 3.5 μ V		
		1 V		± 4 μ V			
		10 V		± 30 μ V	± 40 μ V		
		100 V		± 600 μ V			
		1000 V		± 6 mV			
Short	4-wire Ohms	100 Ω		± 3 m Ω	± 4 m Ω		
		1 k Ω		± 5 m Ω			
		10 k Ω	Q	± 50 m Ω			
		100 k Ω		± 500 m Ω			
		1 M Ω		± 5 Ω			
		10 M Ω		± 100 Ω			
Short	2-wire Ohms	100 M Ω		1 k Ω			

^[1]Select 10 PLC.

^[2]These values are typical and these ranges are calibrated internally.

Q: Quick performance verification test point.

Values for 34470A DMM							
Input	Function ^[1]	Range	Quick Check	Error from Nominal			
				24 hours	90 days	1 year	2 years
Open	DC Current	1 μ A		± 50 pA (50E-12 A) ^[2]			
		10 μ A		± 200 pA (± 200.0 E-12 A) ^[2]			
		100 μ A	Q	± 0.001 μ A ^[2]			
		1 mA		± 0.030 μ A	± 0.050 μ A		
		10 mA		± 2 μ A			
		100 mA		± 4 μ A	± 5 μ A		
		1 A		± 60 μ A	± 100 μ A		
		3 A		± 600 μ A			
		10 A		± 1 ma			
Short	DC Volts	100 mV	Q	± 3 μ V	± 3.5 μ V		
		1 V		± 4 μ V			
		10 V		± 20 μ V			
		100 V		± 600 μ V			
		1000 V		± 6 mV			
Short	4-wire Ohms	100 Ω		± 3 m Ω	± 4 m Ω		
		1 k Ω		± 5 m Ω			
		10 k Ω	Q	± 50 m Ω			
		100 k Ω		± 500 m Ω			
		1 M Ω		± 5 Ω			
		10 M Ω		± 100 Ω			
Short	2-wire Ohms	100 M Ω		1 k Ω			

^[1]Select 10 PLC.

^[2]These values are typical and these ranges are calibrated internally.

Q: Quick performance verification test point.

DC Volts and DC Current Gain Verification

This procedure verifies DC volts and DC current gain.

1. Make sure you have read [Test Considerations](#).
2. Connect the calibrator to the input terminals. For the 34461A/65A/70A, use the front panel input terminals and select the front input terminals with the **Front/Rear** switch.
3. Configure each function and range in the order shown in the table below corresponding to the DMM model number. Provide the input shown in the table.
4. Make a measurement and return the result. Compare measurement results to the test limits shown below. (Be certain to allow for appropriate source settling.)

Values for 34460A DMM							
Input				Error from Nominal			
Voltage	Function ^[1]	Range	Quick Check	24 hours	90 days	1 year	2 years
100 mV	DC Volts	100 mV		± 10 µV	± 13.5 µV	± 15.5 µV	± 18 µV
-100 mV							
1 V		1 V		± 39 µV	± 70 µV	± 90 µV	± 115 µV
-1 V							
4 V		10 V		± 140 µV	± 250 µV	± 350 µV	± 450 µV
10 V		10 V	Q	± 290 µV	± 550 µV	± 800 µV	± 1.1 mV
-10 V							
100 V		100 V		± 3.6 mV	± 7.1 mV	± 9.1 mV	± 11.6 mV
-100 V			Q				
1000 V		1000 V		± 36 mV	± 75 mV	± 95 mV	± 120 mV
-500 V				± 21 mV	± 42.5 mV	± 52.5 mV	± 62.5 mV

^[1]Select 10 PLC.

Q: Quick performance verification test point.

Values for 34460A DMM							
Input				Error from Nominal			
Current	Function ^[1]	Range	Quick Check	24 hours	90 days	1 year	2 years
2 A	DC Current	3 A		± 4.2 mA	± 4.6 mA	± 4.6 mA	± 5.2 mA
1 A		1 A	Q	± 560 µA	± 900 µA	± 1.1 mA	± 1.3 mA
100 mA		100 mA		± 14 µA	± 35 µA	± 55 µA	± 65 µA
10 mA		10 mA	Q	± 2.7 µA	± 5 µA	± 7 µA	± 8 µA
1 mA		1 mA		± 0.13 µA	± 0.36 µA	± 0.56 µA	± 0.66 µA
100 µA		100 µA		± 0.03 µA	± 0.065 µA	± 0.075 µA	± 0.085 µA

^[1]Select 10 PLC.

Q: Quick performance verification test point.

Values for 34460A DMM							
Input				Error from Nominal			
Resistance	Function ^[1]	Range	Quick Check	24 hours	90 days	1 year	2 years
100 Ω	4-wire Ohms	100 Ω		± 10 mΩ	± 18 mΩ	± 21 mΩ	± 24 mΩ
1 kΩ		1 kΩ	Q	± 38 mΩ	± 120 mΩ	± 150 mΩ	± 180 mΩ
10 kΩ		10 kΩ		± 350 mΩ	± 1.2 Ω	± 1.5 Ω	± 1.8 Ω
100 kΩ		100 kΩ		± 3.5 Ω	± 12 Ω	± 15 Ω	± 18 Ω
1 MΩ		1 MΩ		± 40 Ω	± 120 Ω	± 150 Ω	± 180 Ω
10 MΩ		10 MΩ	Q	± 1.6 kΩ	± 2.1 kΩ	± 4.1 kΩ	± 6.1 kΩ
100 MΩ	2-wire Ohms	100 MΩ		± 310 kΩ	± 810 kΩ		

^[1]Select 10 PLC.

Q: Quick performance verification test point.

Values for 34461A DMM							
Input				Error from Nominal			
Voltage	Function ^[1]	Range	Quick Check	24 hours	90 days	1 year	2 years
100 mV	DC Volts	100 mV		± 6 μV	± 7.5 μV	± 8.5 μV	± 10 μV
-100 mV							
1 V		1 V		± 26 μV	± 37 μV	± 47 μV	± 62 μV
-1 V							
4 V		10 V		± 100 μV	± 130 μV	± 190 μV	± 230 μV
10 V			Q	± 190 μV	± 250 μV	± 400 μV	± 500 μV
-10 V							
100 V		100 V		± 2.6 mV	± 4.1 mV	± 5.1 mV	± 6.6 mV
-100 V			Q				
1000 V		1000 V		± 26 mV	± 45 mV	± 55 mV	± 70 mV
-500 V				± 16 mV	± 27.5 mV	± 32.5 mV	± 40 mV

^[1]Select 10 PLC.

Q: Quick performance verification test point.

Values for 34461A DMM							
Input				Error from Nominal			
Current	Function ^[1]	Range	Quick Check	24 hours	90 days	1 year	2 years
2 A	DC Current	3 A		± 4.2 mA	± 4.6 mA	± 4.6 mA	± 5.2 mA
1 A		1 A	Q	± 560 µA	± 900 µA	± 1.1 mA	± 1.3 mA
100 mA		100 mA		± 14 µA	± 35 µA	± 55 µA	± 65 µA
10 mA		10 mA	Q	± 2.7 µA	± 5 µA	± 7 µA	± 8 µA
1 mA		1 mA		± 0.13 µA	± 0.36 µA	± 0.56 µA	± 0.66 µA
100 µA		100 µA		± 0.03 µA	± 0.065 µA	± 0.075 µA	± 0.085 µA

^[1]Select 10 PLC.

Q: Quick performance verification test point.

Values for 34461A DMM							
Input				Error from Nominal			
Resistance	Function ^[1]	Range	Quick Check	24 hours	90 days	1 year	2 years
100 Ω	4-wire Ohms	100 Ω		± 6 mΩ	± 12 mΩ	± 14 mΩ	± 16 mΩ
1 kΩ		1 kΩ	Q	± 25 mΩ	± 90 mΩ	± 110 mΩ	± 130 mΩ
10 kΩ		10 kΩ		± 250 mΩ	± 900 mΩ	± 1.1 Ω	± 1.3 Ω
100 kΩ		100 kΩ		± 2.5 Ω	± 9 Ω	± 11 Ω	± 13 Ω
1 MΩ		1 MΩ		± 30 Ω	± 90 Ω	± 110 Ω	± 130 Ω
10 MΩ	2-wire Ohms	10 MΩ	Q	± 1.6 kΩ	± 2.1 kΩ	± 4.1 kΩ	± 6.1 kΩ
100 MΩ		100 MΩ		± 310 kΩ	± 810 kΩ		

^[1]Select 10 PLC.

Q: Quick performance verification test point.

Values for 34465A DMM							
Input				Error from Nominal			
Current	Function ^[1]	Range	Quick Check	24 hours	90 days	1 year	2 years
2 A	DC Current	3 A		± 4.2 mA	± 4.6 mA	± 4.6 mA	± 5.2 mA
1 A		1 A	Q	± 560 µA	± 800 µA	± 900 µA	± 1.1 mA
100 mA		100 mA		± 14 µA	± 35 µA	± 55 µA	± 65 µA
10 mA		10 mA	Q	± 2.7 µA	± 5 µA	± 7 µA	± 8 µA
1 mA		1 mA		± 0.1 µA	± 0.35 µA	± 0.55 µA	± 0.65 µA

^[1]Select 10 PLC.

Q: Quick performance verification test point.

Values for 34465A DMM								
Input				Error from Nominal				
Voltage	Function ^[1]	Range	Quick Check	24 hours	90 days	1 year	2 years	
100 mV	DC Volts	100 mV		± 6 µV	± 7.5 µV	± 8.5 µV	± 10 µV	
-100 mV								
1 V		1 V		± 19 µV	± 29 µV	± 39 µV	± 54 µV	
-1 V								
4 V		10 V	10 V		± 70 µV	± 120 µV	± 160 µV	± 220 µV
10 V				Q	± 130 µV	± 240 µV	± 340 µV	± 490 µV
-10 V								
100 V			100 V		± 2.6 mV	± 4.1 mV	± 4.6 mV	± 6.1 mV
-100 V		Q						
1000 V		1000 V	1000 V		± 36 mV	± 51 mV	± 56 mV	± 71 mV
-500 V				± 16 mV	± 23.5 mV	± 26 mV	± 33.5 mV	

^[1]Select 10 PLC.

Q: Quick performance verification test point.

Values for 34465A DMM							
Input				Error from Nominal			
Resistance	Function ^[1]	Range	Quick Check	24 hours	90 days	1 year	2 years
100 Ω	4-wire Ohms	100 Ω		± 6 mΩ	± 9 mΩ	± 10 mΩ	± 11 mΩ
1 kΩ		1 kΩ	Q	± 25 mΩ	± 35 mΩ	± 45 mΩ	± 55 mΩ
10 kΩ		10 kΩ		± 250 mΩ	± 350 mΩ	± 450 mΩ	± 550 mΩ
100 kΩ		100 kΩ		± 2.5 Ω	± 3.5 Ω	± 4.5 Ω	± 5.5 Ω
1 MΩ		1 MΩ		± 25 Ω	± 65 Ω	± 75 Ω	± 85 Ω
10 MΩ		10 MΩ		± 1.1 kΩ	± 2.1 kΩ	± 2.6 kΩ	± 3.1 kΩ
10 MΩ	2-wire Ohms	10 MΩ	Q				
100 MΩ		100 MΩ		± 101 kΩ	± 201 kΩ	± 301 kΩ	± 401 kΩ

^[1]Select 10 PLC.

Q: Quick performance verification test point.

Values for 34470A DMM							
Input				Error from Nominal			
Current	Function ^[1]	Range	Quick Check	24 hours	90 days	1 year	2 years
2 A	DC Current	3 A		± 4.2 mA	± 4.6 mA		± 5.2 mA
1 A		1 A	Q	± 560 µA	± 800 µA	± 900 µA	± 1.1 mA
100 mA		100 mA		± 14 µA	± 35 µA	± 55 µA	± 65 µA
10 mA		10 mA	Q	± 2.7 µA	± 5 µA	± 7 µA	± 8 µA
1 mA		1 mA		± 0.1 µA	± 0.35 µA	± 0.55 µA	± 0.65 µA

^[1]Select 10 PLC.

Q: Quick performance verification test point.

Values for 34470A DMM								
Input				Error from Nominal				
Voltage	Function ^[1]	Range	Quick Check	24 hours	90 days	1 year	2 years	
100 mV	DC Volts	100 mV		± 6 µV	± 7.5 µV		± 8 µV	
-100 mV								
1 V		1 V		± 14 µV	± 19 µV	± 24 µV	± 29 µV	
-1 V								
4 V		10 V		± 52 µV	± 72 µV	± 84 µV	± 100 µV	
10 V			Q	± 100 µV	± 150 µV	± 180 µV	± 220 µV	
-10 V								
100 V		100 V			± 2.6 mV	± 3.8 mV	± 4.4 mV	± 4.6 mV
-100 V			Q					
1000 V		1000 V			± 36 mV	± 48 mV	± 54 mV	± 56 mV
-500 V				± 16 mV	± 22 mV	± 25 mV	± 36 mV	

^[1]Select 10 PLC.

Q: Quick performance verification test point.

Values for 34470A DMM							
Input				Error from Nominal			
Resistance	Function ^[1]	Range	Quick Check	24 hours	90 days	1 year	2 years
100 Ω	4-wire Ohms	100 Ω		± 6 mΩ	± 9 mΩ	± 10 mΩ	± 11 mΩ
1 kΩ		1 kΩ	Q	± 25 mΩ	± 35 mΩ	± 45 mΩ	± 55 mΩ
10 kΩ		10 kΩ		± 250 mΩ	± 350 mΩ	± 450 mΩ	± 550 mΩ
100 kΩ		100 kΩ		± 2.5 Ω	± 3.5 Ω	± 4.5 Ω	± 5.5 Ω
1 MΩ		1 MΩ		± 25 Ω	± 65 Ω	± 75 Ω	± 85 Ω
10 MΩ		10 MΩ			± 1.1 kΩ	± 2.1 kΩ	± 2.6 kΩ
10 MΩ	2-wire Ohms	10 MΩ	Q				
100 MΩ		100 MΩ		± 101 kΩ	± 201 kΩ	± 301 kΩ	± 401 kΩ

^[1]Select 10 PLC.

Q: Quick performance verification test point.

Frequency Accuracy Verification

Configuration: Frequency (CONFigure:FREQUENCY DEF, MIN)

1. Make sure you have read [Test Considerations](#).
2. Select the Frequency function, default range, 3 Hz filter, and 1 second aperture.
3. Connect the Keysight 33500B Series Function/Arbitrary Waveform Generator to the input terminals. For the 34461A/65A/70A, use the front panel input terminals and select the front input terminals with the **Front/Rear** switch.
4. Select each range in the order shown below. Provide the indicated input voltage and frequency. Compare measurement results to the test limits shown below. (Be certain to allow for appropriate source settling.)

Values for 34460A DMM							
Input				Error from Nominal			
Vrms	Frequency	Range	Quick Check	24 hours	90 days	1 year	2 years
0.1 Vrms	10 Hz	1 Vrms		± 3 mHz			± 3.5 mHz
0.01 Vrms	300 kHz	0.1 Vrms	Q	± 60 Hz	± 240 Hz	± 360 Hz	± 510 Hz

Values for 34461A DMM							
Input				Error from Nominal			
Vrms	Frequency	Range	Quick Check	24 hours	90 days	1 year	2 years
0.1 Vrms	10 Hz	1 Vrms		± 3 mHz			± 3.5 mHz
0.01 Vrms	300 kHz	0.1 Vrms	Q	± 60 Hz	± 180 Hz	± 300 Hz	± 450 Hz

Values for 34465A and 34470A DMMs							
Input				Error from Nominal			
Vrms	Frequency	Range	Quick Check	24 hours	90 days	1 year	2 years
0.1 Vrms	10 Hz	1 Vrms		± 3 mHz			
0.01 Vrms	300 kHz	0.1 Vrms	Q	± 60 Hz	± 150 Hz	± 210 Hz	± 270 Hz

Q: Quick performance verification test point.

AC Voltage and AC Current Verification

This procedure verifies AC voltage and current.

1. Make sure you have read [Test Considerations](#).
2. Connect the calibrator to the input terminals. For the 34461A/65A/70A, use the front panel input terminals and select the front input terminals with the **Front/Rear** switch.
3. Set the AC Volts or AC Current function and the filter as shown below.
4. Select each range in the order shown below. Provide the indicated input voltage and frequency. Compare measurement results to the test limits shown below. (Be certain to allow for appropriate source settling.)

ACV Values for 34460A DMM								
Input					Error from Nominal			
Vrms	Frequency	Range	Filter	Quick Check	24 hours	90 days	1 year	2 years
100 mV	1 kHz	100 mV	200 Hz		± 90 µV	± 110 µV	± 120 µV	± 130 µV
	50 kHz				± 170 µV	± 190 µV	± 200 µV	± 210 µV
	300 kHz			Q	± 4.5 mV			
1 V	1 kHz	1 V	200 Hz		± 900 µV	± 1.1 mV	± 1.2 mV	± 1.3 mV
	50 kHz				± 1.7 mV	± 1.9 mV	± 2 mV	± 2.1 mV
	300 kHz				± 45 mV			
0.03 V	1 kHz	10 V	200 Hz		± 2 mV	± 3 mV		
1 V	1 kHz		200 Hz		± 2.7 mV	± 3.8 mV	± 3.9 mV	± 4 mV
10 V	10 Hz		3 Hz		± 9 mV	± 11 mV	± 12 mV	± 13 mV
	100 Hz		20 Hz		± 9 mV	± 11 mV	± 12 mV	± 13 mV
	20 kHz		200 Hz		± 9 mV	± 11 mV	± 12 mV	± 13 mV
	50 kHz			Q	± 17 mV	± 19 mV	± 20 mV	± 21 mV
	100 kHz		200 Hz		± 66 mV	± 71 mV		
	300 kHz				± 450 mV			
100 V	1 kHz	100 V	200 Hz	Q	± 90 mV	± 110 mV	± 120 mV	± 130 mV
	50 kHz				± 170 mV	± 190 mV	± 200 mV	± 210 mV
70 V	300 kHz				± 3.3 V			
750 V	1 kHz	750 V	200 Hz		± 675 mV	± 825 mV	± 900 mV	± 975 mV
210 V	50 kHz				± 573 mV	± 669 mV	± 690 mV	± 711 mV
70 V	300 kHz				± 6.6 V			

Q: Quick performance verification test point.

ACV Values for 34461A DMM								
Input			Filter	Quick Check	Error from Nominal			
Vrms	Frequency	Range			24 hours	90 days	1 year	2 years
100 mV	1 kHz	100 mV	200 Hz		± 60 µV	± 80 µV	± 90 µV	± 100 µV
	50 kHz				± 140 µV	± 160 µV	± 170 µV	± 180 µV
	300 kHz			Q	± 4.5 mV			
1 V	1 kHz	1 V	200 Hz		± 600 µV	± 800 µV	± 900 µV	± 1 mV
	50 kHz				± 1.4 mV	± 1.6 mV	± 1.7 mV	± 1.8 mV
	300 kHz				± 45 mV			
0.03 V	1 kHz	10 V	200 Hz		± 2 mV	± 3 mV		
1 V	1 kHz		200 Hz		± 2.4 mV	± 3.5 mV	± 3.6 mV	± 3.7 mV
10 V	10 Hz		3 Hz		± 6 mV	± 8 mV	± 9 mV	± 10 mV
	100 Hz		20 Hz		± 6 mV	± 8 mV	± 9 mV	± 10 mV
	20 kHz		200 Hz		± 6 mV	± 8 mV	± 9 mV	± 10 mV
	50 kHz		200 Hz	Q	± 14 mV	± 16 mV	± 17 mV	± 18 mV
	100 kHz				± 63 mV	± 68 mV		
300 kHz			± 450 mV					
100 V	1 kHz	100 V	200 Hz	Q	± 60 mV	± 80 mV	± 90 mV	± 100 mV
	50 kHz				± 140 mV	± 160 mV	± 170 mV	± 180 mV
70 V	300 kHz				± 3.3 V			
750 V	1 kHz	750 V	200 Hz		± 450 mV	± 600 mV	± 675 mV	± 750 mV
210 V	50 kHz				± 510 mV	± 606 mV	± 627 mV	± 648 mV
70 V	300 kHz				± 6.6 V			

Q: Quick performance verification test point.

ACI Values for 34460A and 34461A DMMs								
Input					Error from Nominal			
Current, rms	Frequency	Range	Filter	Quick Check	24 hours	90 days	1 year	2 years
2 A	1 kHz	3 A	200 Hz		± 5.8 mA			
	5 kHz							
1 A	1 kHz	1 A	200 Hz		± 1.4 mA			
	5 kHz							
100 mA	10 Hz	100 mA	3 Hz		± 140 µA			
	1 kHz		200 Hz					
	5 kHz		200 Hz					
100 µA	1 kHz	10 mA	200 Hz		4.1 µA			
1 mA	1 kHz				5 µA			
10 mA	1 kHz				14 µA			
	5 kHz							
1 mA	1 kHz	1 mA	200 Hz		1.4 µA			
	5 kHz							
100 µA	1 kHz	100 µA	200 Hz		0.14 µA			
	5 kHz			Q				

Q: Quick performance verification test point.

ACV Values for 34465A and 34470A DMMs								
Input			Filter	Quick Check	Error from Nominal			
Vrms	Frequency	Range			24 hours	90 days	1 year	2 years
100 mV	1 kHz	100 mV	200 Hz		± 40 µV	± 60 µV	± 70 µV	± 80 µV
	50 kHz				± 80 µV	± 90 µV	± 100 µV	± 110 µV
	300 kHz			Q	± 1.1 mV			
1 V	1 kHz	1 V	200 Hz		± 400 µV	± 600 µV	± 700 µV	± 800 µV
	50 kHz				± 800 µV	± 900 µV	± 1 mV	± 1.1 mV
	300 kHz				± 11 mV			
0.03 V	1 kHz	10 V	200 Hz		± 2 mV			
1 V	1 kHz		200 Hz		± 2.2 mV	± 2.4 mV	± 2.5 mV	± 2.6 mV
10 V	10 Hz		3 Hz		± 4 mV	± 6 mV	± 7 mV	± 8 mV
	100 Hz		20 Hz					
	20 kHz		200 Hz					
	50 kHz		200 Hz	Q	± 8 mV	± 9 mV	± 10 mV	± 11 mV
	100 kHz				± 20 mV			
300 kHz			± 110 mV					
100 V	1 kHz	100 V	200 Hz	Q	± 40 mV	± 60 mV	± 70 mV	± 80 mV
	50 kHz				± 80 mV	± 90 mV	± 100 mV	± 110 mV
70 V	300 kHz				± 800 mV			
750 V	1 kHz	750 V	200 Hz		± 750 mV	± 900 mV	± 975 mV	± 1.1 V
210 V	50 kHz				± 330 mV	± 351 mV	± 372 mV	± 393 mV
70 V	300 kHz				± 1.5 V			

Q: Quick performance verification test point.

ACI Values for 34465A and 34470A DMMs								
Input			Filter	Quick Check	Error from Nominal			
Current, rms	Frequency	Range			24 hours	90 days	1 year	2 years
2 A	1 kHz	3 A	200 Hz		± 5.8 mA			
	5 kHz							
1 A	1 kHz	1 A	200 Hz		± 1.1 mA	± 1.3 mA	± 1.4 mA	
	5 kHz							
100 mA	10 Hz	100 mA	3 Hz		± 110 µA	± 130 µA	± 140 µA	
	1 kHz		200 Hz					
	5 kHz		200 Hz	Q				
100 µA	1 kHz	10 mA	200 Hz		± 4.1 µA			
1 mA	1 kHz				± 4.7 µA	± 4.9 µA	± 5 µA	
10 mA	1 kHz					± 11 µA	± 13 µA	± 14 µA
	5 kHz							

ACI Values for 34465A and 34470A DMMs								
Input					Error from Nominal			
Current, rms	Frequency	Range	Filter	Quick Check	24 hours	90 days	1 year	2 years
1 mA	1 kHz	1 mA	200 Hz	Q	± 1.1 µA	± 1.3 µA	± 1.4 µA	
	5 kHz							
100 µA	1 kHz	100 µA	200 Hz		± 0.110 µA	± 0.130 µA	± 0.140 µA	
	5 kHz							

Q: Quick performance verification test point.

High Current Verification

This procedure applies to the 34461A, 34465A, and 34470A only (not applicable to the 34460A).

This procedure verifies AC and DC current on the 10 A terminals.

1. Make sure you have read [Test Considerations](#).
2. Connect the calibrator to the front 10 A input terminals and select the Front input terminals with the **Front/Rear** switch.
3. Select each function in the order shown below. Provide the indicated input current and frequency, and for ACI, use the 200 Hz input filter. Compare measurement results to the test limits shown below. (Be certain to allow for appropriate source settling.)

Values for the 34461A, 34465A, and 34470A DMMs								
Input				Error from Nominal				
Function	Current [1]	Frequency	Range	Quick Check	24 hours	90 days	1 year	2 years
DCI	5 A	N/A	10 A		± 3.5 mA	± 7 mA		± 8.5 mA
DCI	10 A	N/A	10 A	Q	± 16 mA	± 23 mA		± 26 mA
ACI	10 A	5 kHz	10 A		± 24 mA	± 29 mA		

^[1] If you are NOT using the Fluke 5725 for calibration, reduce the current to 2 A.

Capacitance Verification (Optional Verification Test)

This optional procedure verifies capacitance accuracy.

1. Make sure you have read [Test Considerations](#).
2. Select the Capacitance measurement function.
3. Connect the capacitance calibrator to the front input terminals and select the front input terminals with the Front/Rear switch.
4. Select each range in the order shown below. Provide the indicated input.
5. Compare measurement results to the test limits shown in the table. (Be certain to allow time for source settling.)

Input		
Capacitance	Range	Error from Nominal
1 μ F	1 μ F	$\pm 0.005 \mu$ F
1 μ F	10 μ F	$\pm 0.014 \mu$ F

Calibration Adjustment Procedures

You will need a test input cable and connectors set and a low thermal input short, Keysight 34172B, to calibrate the instrument (see [Input Connections](#)). Two input shorts are recommended for the 34461A/65A/70A.

- [Calibration Process Overview](#)
- [34460A and 34461A Calibration Procedures](#)
- [34465A and 34470A Calibration Procedures](#)

Calibration Procedures

This section contains procedures for adjusting the instrument's performance (calibration).

NOTE

There is no separate calibration for Diode or Continuity, because these functions are based on the resistance measurement, which is calibrated. Also, there is no calibration for gate time because this functionality is controlled by digital logic. There is no calibration for capacitance gain and, for the 34465A and 34470A, no calibration on the 1, 10, and 100 μA DCI ranges

Use one of the following sets of procedures based on the DMM model number:

- [34460A and 34461A Calibration Procedures](#)
- [34465A and 34470A Calibration Procedures](#)

Closed-Case Electronic Calibration

The instrument uses closed-case electronic calibration; no internal mechanical adjustments are required. The instrument calculates correction factors based on reference signals that you apply and stores the correction factors in non-volatile memory. This data is not changed by cycling power, ***RST**, or **SYSTem:PRESet**.

Keysight Technologies Calibration Services

Keysight Technologies offers calibration services using automated calibration systems that enable Keysight to provide calibration at competitive prices. See [Types of Service Available](#) for information on contacting Keysight.

Calibration Adjustment Interval

The instrument should be calibrated on a regular interval determined by the accuracy requirements of your application. A 1-year interval is adequate for most applications. Accuracy specifications are warranted only if calibration is made at regular calibration intervals. Keysight Technologies never recommends calibration adjustment intervals beyond two years.

Calibration is Recommended

Whatever calibration interval you select, Keysight Technologies recommends that complete re-calibration should always be performed at the calibration interval. This ensures that the instrument will remain within specifications for the next calibration interval and provides the best long-term stability. Performance data measured during performance verification tests does not mean that the instrument will remain within these limits unless the calibration adjustments are performed. Use the calibration count to verify that all calibration adjustments have been performed.

Time Required for Calibration Adjustment

The instrument can be automatically calibrated under computer control, including complete calibration adjustment procedure and performance verification tests, in less than 30 minutes once the instrument is warmed-up (see Test Considerations).

Automating Calibration Adjustment Procedures

The calibration procedures demonstrate front panel calibration. You can automate the complete verification and calibration procedures outlined in this manual. You can program the instrument configurations specified for each test over the remote interface. You can then enter read back verification data into a test program and compare the results to the appropriate test limit values.

The instrument must be unsecured to calibrate. See [Calibration Security](#) for details.

Refer to the [CALibration Subsystem](#) for information on SCPI programming.

Input Connections

Test connections to the instrument are best accomplished using a Keysight Technologies 34172B calibration short for low-thermal offset measurements and a 34171B DMM connector configured to interface to the calibrator output. Shielded, twisted-pair, PTFE interconnect cables of minimum length are recommended between the calibrator and the multimeter to reduce settling and noise errors. HI and HI Sense should be a twisted pair. LO and LO Sense should be a twisted pair. Cable shields should be earth ground referenced. This configuration is recommended for noise reduction and settling time performance during calibration.

Test Considerations

Errors may be induced by AC signals present on the input leads during a self-test. Long test leads can also act as an antenna causing pick-up of AC signals.

For optimum performance:

- Ensure that the calibration ambient temperature (T_{cal}) is stable and between 18 °C and 28 °C. Ideally the calibration should be performed at 23 °C \pm 2 °C.
- Ensure ambient relative humidity is less than 80%.
- Allow a 90 minute warm-up period with a copper short connected.
- Connect the input cable shields to earth ground. Except where noted in the procedures, connect the calibrator LO source to earth ground at the calibrator. It is important that the LO to earth ground connection be made at only one place in the circuit to avoid ground loops.

Because the instrument is capable of making highly accurate measurements, you must take care to ensure that the calibration standards and test procedures do not introduce additional errors. Ideally, the standards used to verify and adjust the instrument should be an order of magnitude more accurate than each instrument range full scale error specification.

For 2-wire ohms measurements, remove lead resistance by doing a null measurement with the leads shorted or with a precision 4-terminal low thermal short. For offset calibration a 4-terminal low thermal short is required.

Recommended Test Equipment

The recommended test equipment for the performance verification and calibration is listed below. If the exact instrument is not available, substitute calibration standards of equivalent accuracy.

An alternate method is to use the Keysight 3458A 8½-digit Digital Multimeter to measure less accurate, yet stable, sources. The output value measured from the source can be entered into the instrument as the target calibration value.

Application	Recommended Equipment
Zero Calibration	Keysight 34172B
DC Voltage	Fluke 5720A
DC Current	Fluke 5720A
Resistance	Fluke 5720A
AC Voltage	Fluke 5720A
AC Current	Fluke 5720A
Frequency	Keysight 33500B Series Function/Arbitrary Waveform Generator
High Current	Fluke 5725A
Capacitance (Optional)	SCA-1uF Capacitance Standard

Calibration Adjustment Process

The following general procedure is recommended to complete a full calibration adjustment.

1. Read [Test Considerations](#).
2. Perform the [performance verification tests](#) to characterize the instrument (incoming data).
3. Unsecure the instrument for calibration (see [Calibration Security](#)).
4. Perform the calibration procedures (see [Calibration Procedures](#)).
5. Secure the instrument against calibration (see [Calibration Security](#)).
6. Note the security code and calibration count in the instrument's maintenance records.
7. Perform the [performance verification tests](#) to verify the calibration.

Gain Calibration Adjustment Overview

The ADC and zero calibration adjustment procedure must have been recently performed before beginning gain calibration. Gain calibrations can be made using either the front or rear input (not available on the 34460A) terminals. On the 34461A/65A/70A, make sure the **Front/Rear** switch matches the terminals in use.

CAUTION Never turn off the instrument during a gain or flatness calibration. This may cause calibration memory for the present function to be lost.

Valid Gain and Flatness Calibration Input Values

Gain calibration can be accomplished using the following input values.

Function	Range	Valid Amplitude Input Values
DC Volts	100 mV to 100 V	0.9 to 1.1 x Full Scale
	1000 V	450 to 1000 V
DC Current	100 μ A to 1 A	0.9 to 1.1 x Full Scale
	3 A	1.5 A to 2.5 A
	10 A	1.8 A to 10 A
Ohms (2W and 4W)	100 Ω to 100 M Ω	0.9 to 1.1 x Full Scale
Frequency	Auto	Input > 100 mV rms, 9.9 kHz to 110 kHz
AC Current (rms) ^[1]	100 μ A to 1 A	0.9 to 1.1 x Full Scale
	3 A	0.9 A to 2 A
	10 A	2 A to 10 A
AC Volts (rms) ^[1]	100 mV to 10 V	0.9 to 1.1 x Full Scale
	100 V	40 V to 110 V
	750 V	400 to 750 V

^[1] Valid frequencies are nominal frequencies $\pm 1\%$.

Gain and Flatness Calibration Adjustment Overview

The instrument stores new flatness correction constants each time this procedure is followed. Flatness constants adjust the DMM for AC Volts and AC current measurements across the usable input frequency band. The flatness constant is computed from the calibration value entered for the calibration command and from measurements made automatically during the calibration procedure.

Calibrations for each range and frequency should be performed in the order shown.

Flatness Calibration Considerations

The ADC and zero calibration adjustment procedure must have been recently performed before beginning gain calibration. Flatness calibrations can be made using either the front or the rear input terminals. On the 34461A/65A/70A, make sure the **Front/Rear** switch matches the terminals in use.

CAUTION Never turn off the instrument during a gain or flatness calibration. This may cause calibration memory for the present function to be lost.

Gain Calibration

The instrument calculates and stores gain corrections for each input value. The gain constant is computed from the calibration value entered for the calibration command and from measurements made automatically during the calibration procedure.

Most measurement functions and ranges have gain calibration procedures, and calibration for each function should be performed in the order shown.

Entering Calibration Values and Storing Calibration Constants

Selecting the Calibration Mode

Use the CALibration:ADC? query to begin ADC calibration. The response to this query indicates a successful calibration (0) or a failure (1). Following the ADC calibration, use the measurement commands to set the DMM measurement parameters and functions for the mode being calibrated.

Front Panel: [Utility] > Test/Admin > Calibrate > Perform Cal > Cal Value > Perform ADC Cal

Entering Calibration Values

To enter a calibration value from the remote interface use CALibration:VALue <value> followed by the CALibration? query. The response to the query indicates whether the calibration is valid.

Front Panel: [Utility] > Test/Admin > Calibrate > Perform Cal > Cal Value > (enter value) > Perform Cal Step

Storing the Calibration Constants

To store calibration values in non-volatile memory, use CALibration:STORe.

Front Panel: [Utility] > Test/Admin > Calibrate > Save Cal Values

NOTE

You must have performed a successful calibration immediately before pressing **Save Cal Values**.

Calibration Security

This section describes the instrument's calibration security system. If you forget the security code, you can [override calibration security](#).

Security Overview

A security code prevents accidental or unauthorized instrument calibration.

- When shipped from the factory, the instrument is secured, with the security code set to **AT3446XA**.
- The same security code must be used for front panel and remote operation. If you secure the instrument from the front panel, use that same code to unsecure it from the remote interface.
- This setting is non-volatile; it will not be changed by power cycling or [*RST](#) or [SYSTem:PRESet](#).
- Security code rules:
 - Unquoted string up to 12 characters
 - Must start with letter (A-Z)
 - May contain letters, numbers (0-9) and underscores
- **Front Panel:** [Utility] > Test / Admin > Security
- **SCPI:** [CALibration:SECure:STATe](#)

Calibration Message

You can store a message of up to 40 characters in calibration memory. For example, you could store the date of the last calibration, the date the next calibration is due, or the name and phone number of the person responsible for calibration.

To read the calibration message, press **Utility > Test/Admin > Calibrate** or send CALibration:STRing? from the remote interface.

To change the calibration message, unsecure the instrument and press **Utility > Test/Admin > Calibrate > Edit Cal String** or send CALibration:STRing "<string>" from the remote interface.

Calibration Count

You can query the instrument to determine how many calibrations have been performed. Because the value increments each time you store the calibration constants, a complete calibration adds many counts. The calibration count also increments whenever you save a calibration string, change the calibration password, or override the calibration security.

Your instrument was calibrated at the factory. When you receive your instrument, be sure to read the count to determine its initial value.

To read the calibration count, press **[Utility] > Test/Admin > Calibrate** on the front panel or send [CALibration:COUNT?](#) from the remote interface. You can read the calibration count regardless of whether the instrument is secured.

Aborting a Calibration in Progress

Sometimes it may be necessary to abort a calibration. You can abort a calibration at any time on any module by turning off the power or issuing a remote interface device clear message.

CAUTION

If you abort a calibration in progress when the instrument is attempting to write new calibration constants to EEPROM, you may lose all calibration constants for the function. Typically, upon re-applying power, the instrument will report error 705 Cal:Aborted. It may also generate errors 740 through 742. If this occurs, you should not use the instrument until a complete re-calibration has been performed. See the [list of calibration errors](#) for more information.

Security Code Override

The instrument security code is set to AT3446XA at the factory. If it has been changed and you no longer remember the code, you can reset the code back to its factory default value by using one of the two following procedures.

Which Procedure Should I Use?

From the instrument front panel, press **[Shift]** > **[Help]** > **About** to view the instrument firmware revision. An example display is:

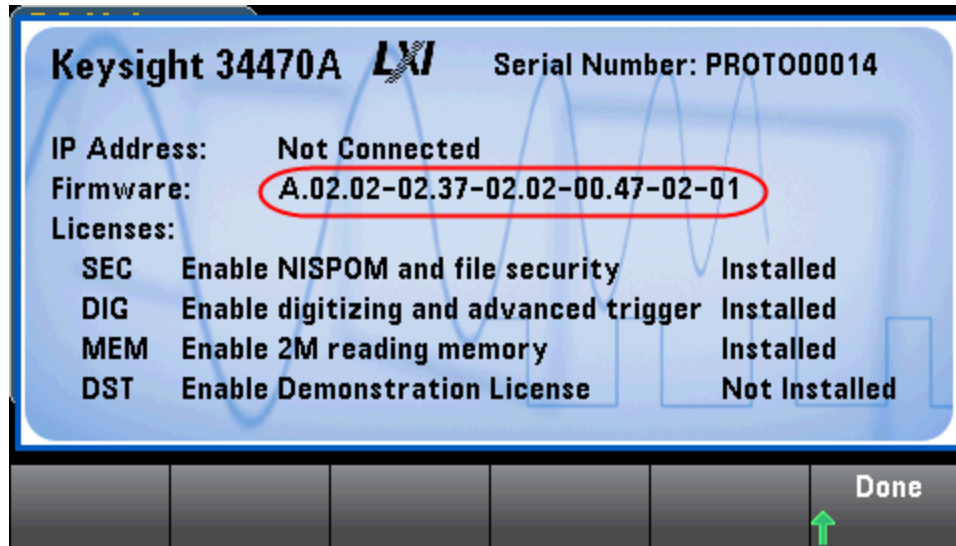

The last two digits of the firmware revision indicate the front panel PC board revision and which of the two procedures you should use. If the firmware revision ends with 02 or greater, use [Procedure A](#). If the firmware revision ends with 01, use [Procedure B](#).



If you encounter problems, contact Keysight Technologies for technical support.

In the United States: (800) 829-4444

In Europe: 31 20 547 2111

In Japan: 0120-421-345

Use www.keysight.com/find/assist to contact Keysight worldwide, or contact your Keysight Technologies representative.

Procedure A: For Firmware Revision Ending in 02, or Greater

WARNING

This procedure should be performed by qualified service personnel only. Turn off the power and remove all measurement leads and other cables, including the power cord, from the instrument before continuing.

1. Follow the [disassembly procedure](#) to disassemble the instrument.
2. Locate connector J102 on the front panel board. Short pin A1 to B1 as shown by the orange line below.

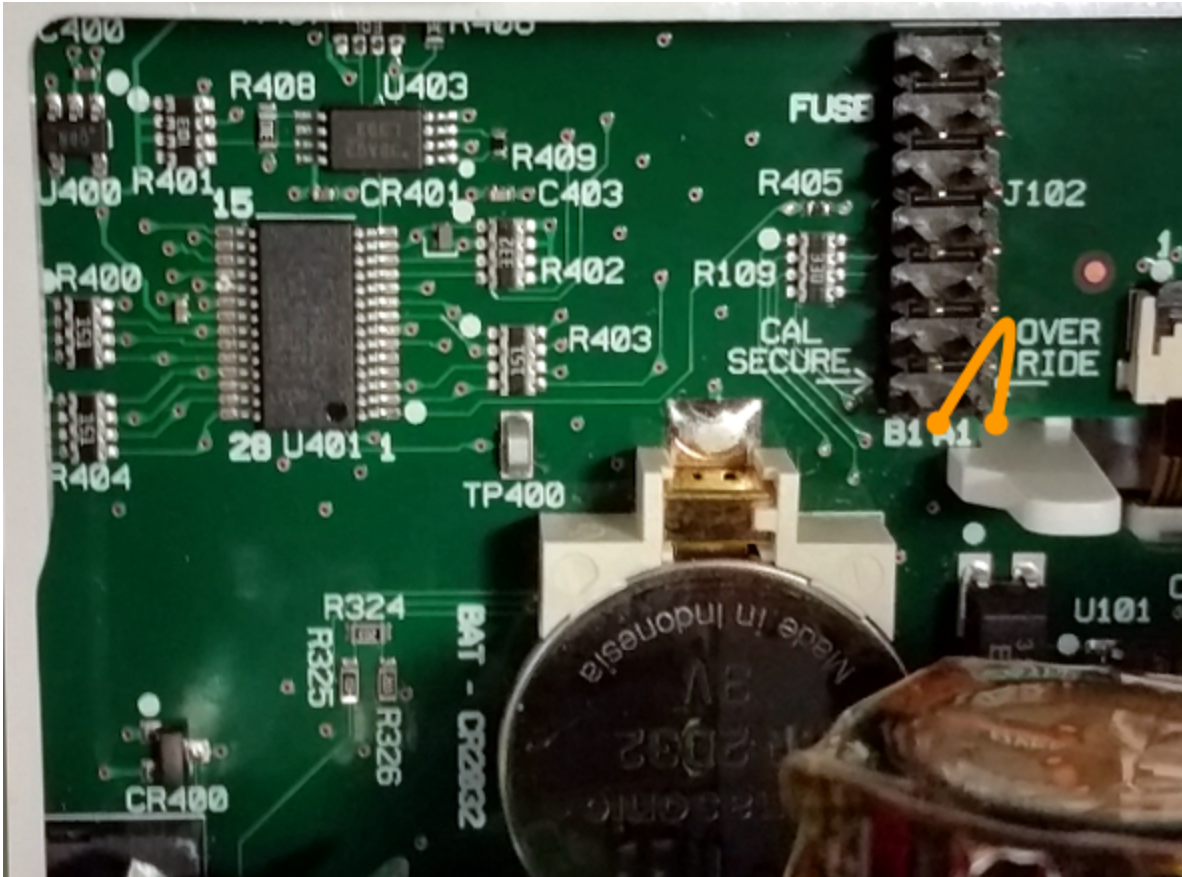

3. Reassemble the instrument, apply power and turn it on; the instrument will generate an error and beep (this is normal). Wait 30 to 40 seconds for the instrument to power up completely.
4. Reset the security code to the factory default:
 - a. Press **[Shift]** > **[Utility]** > **Test / Admin** > **Security** > **New Code**.
 - b. Enter AT3446XA as the new passcode.
 - c. Press **Done**.
 - d. Verify the new code and press **Yes** to confirm the change.

Calibration Adjustment Procedures

5. Remove power, disassemble the instrument, and remove the short. Then reassemble the instrument to complete the security code reset procedure.

Procedure B: For Firmware Revision Ending in 01**WARNING**

This procedure should be performed by qualified service personnel only. Turn off the power and remove all measurement leads and other cables, including the power cord, from the instrument before continuing.

1. Follow the [disassembly procedure](#) to disassemble the instrument.
2. Locate connector J102 on the front panel board. Short pin A1 to A6 or A7 as shown by the orange lines below. You do not need to short both pins to A1, just one of them.

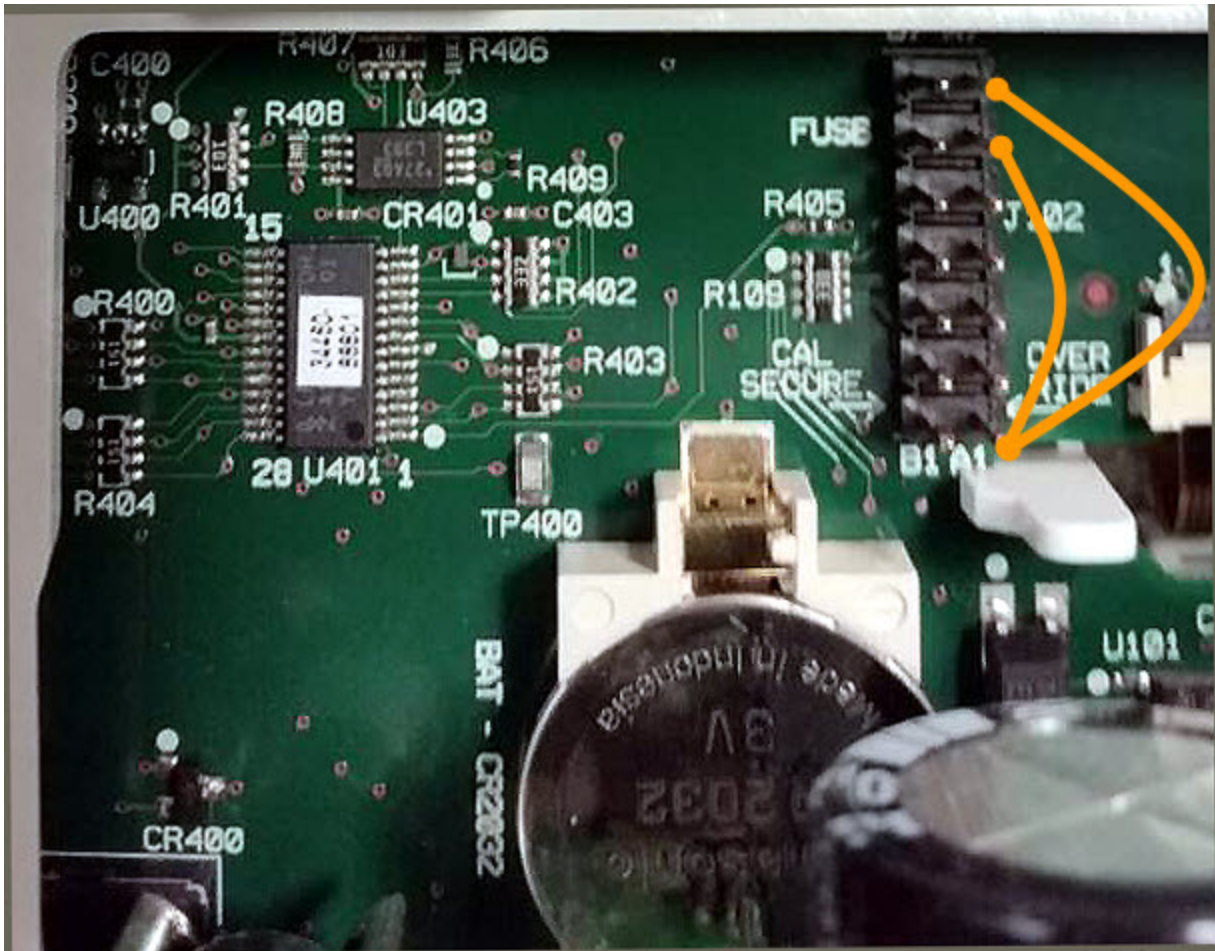

3. Reassemble the instrument, apply power and turn it on; the instrument will generate an error and beep (this is normal). Wait 30 to 40 seconds for the instrument to power up completely.

Calibration Adjustment Procedures

4. Reset the security code to the factory default:
 - a. Press **[Shift]** > **[Utility]** > **Test / Admin** > **Security** > **New Code**.
 - b. Enter AT3446XA as the new passcode.
 - c. Press **Done**.
 - d. Verify the new code and press **Yes** to confirm the change.
5. Remove power, disassemble the instrument, and remove the short. Then reassemble the instrument to complete the security code reset procedure.

34460A and 34461A Calibration Procedures

The following calibration procedures apply only to the 34460A and 34461A DMMs. Perform the calibration procedures in the order listed in this document. Use the arrow links at the bottom of every page to go to the next calibration procedure.

1. [ADC and Zero Calibration Procedure](#)
2. [AC Voltage Low Freq Gain and Flatness Cal](#)
3. [AC Voltage Gain and Flatness Calibration](#)
4. [AC Current Gain and Flatness Calibration](#)
5. [AC Zero Calibration](#)
6. [Frequency Accuracy Calibration](#)
7. [DC Voltage Gain Calibration](#)
8. [Ohms Gain Calibration](#)
9. [DC Current Gain Calibration](#)
10. [AC Current 10 A Gain Calibration](#)
11. [DC Current 10 A Gain Calibration](#)
12. [Capacitance Offset Calibration \(Optional\)](#)
13. [Finishing Calibration](#)

[First Procedure](#)

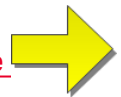

ADC and Zero Calibration

Each time you perform a zero calibration, the instrument stores a new set of offset correction constants for every measurement function and range. The instrument sequences through all required functions and ranges automatically and stores new zero offset calibration constants. All offset corrections are determined automatically. You may not correct a single range or function without re-entering ALL zero offset correction constants automatically. This feature is intended to save calibration time and improve zero calibration consistency.

CAUTION Never turn off the instrument during Zero Calibration. This may cause ALL calibration memory to be lost.

ADC and DC Zero Calibration Procedure

This calibration procedure applies to all models (34460A/61A/65A/70A).

Be sure to allow the instrument to warm up and stabilize for 90 minutes before performing the calibration.

1. Follow the steps outlined below. Review [Test Considerations](#) before beginning this test.
2. This procedure uses a low-thermal shorting block installed on the input connectors.

NOTE For the 34461A/65A/70A, two shorting blocks are recommended; one on the front panel and one on the rear panel. A single shorting block can be used with the 34460A.

3. Select the front panel input terminals. Install a shorting block on the front panel input terminals.
4. Select the ADC calibration mode ([Utility] > Test/Admin > Calibrate > Perform Cal > Perform ADC Cal).
5. The display will show a message indicating that ADC calibration is in process. It will then display the results of the ADC calibration. A Calibration Step Succeeded message indicates success; if the display shows Calibration Step Failed, check the input value, range, function, and entered calibration value and repeat the calibration step. Press **Save Cal Values**.
6. Select the DCV measurement function. Enter a calibration value of +0.
7. Press [Utility] > Test/Admin > Calibrate > Perform Cal > Perform Cal Step.
8. The Zero Calibration lasts approximately two minutes. A Calibration Step Succeeded message indicates success; if the display shows Calibration Step Failed, check the input value, range, function, and entered calibration value and repeat the calibration step.
9. Press **Save Cal Values**.
10. Select the rear input terminals. Install a shorting block rear-panel input terminals.
11. Repeat steps 4 through 9 for the rear input terminals.
12. Store the new ADC and Zero calibration constants (see Storing the Calibration Constants).

NOTE The following gain and flatness calibration procedures can be done using either the front or rear terminals (rear terminals not available on the 34460A). On the 34461A/65A/70A, make sure the **Front/Rear** switch matches the terminals in use.

[Next Procedure](#) 

AC Voltage Low Frequency Gain and Flatness Calibration

This calibration procedure applies to all models (34460A/61A/65A/70A).

Review [Test Considerations](#) and [Flatness Calibration Considerations](#) before performing any calibration.

Configuration: AC Voltage

1. Configure the range shown in the table below.
2. Apply the input signal shown in the Input column.
3. Enter the actual applied input voltage amplitude (see [Entering Calibration Values](#)). A Calibration Step Succeeded message indicates success; if the display shows Calibration Step Failed, check the input value, range, function, and entered calibration value and repeat the calibration step.
4. Repeat steps 1 through 3 for each flatness calibration point shown in the table.
5. Store the new calibration constants (see [Storing the Calibration Constants](#)).

NOTE Each voltage and frequency takes approximately 2.5 seconds to complete.

Input		Instrument
Vrms	Frequency	Range
7 V	10 Hz	10 V
7 V	40 Hz	10 V

[Next Procedure](#)

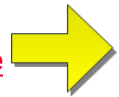

AC Voltage Gain and Flatness Calibration

This calibration procedure applies to all models (34460A/61A/65A/70A).

Review [Test Considerations](#) and [Flatness Calibration Considerations](#) before performing any calibration.

Configuration: AC Voltage

All AC calibration procedures use the 3 Hz bandwidth measurement filter.

1. Configure each function and range in the order shown in the table below.
2. Apply the input signal shown in the Input column.
3. Enter the actual applied input voltage amplitude (see [Entering Calibration Values](#)). A Calibration Step Succeeded message indicates success; if the display shows Calibration Step Failed, check the input value, range, function, and entered calibration value and repeat the calibration step.
4. Repeat steps 1 through 3 for each flatness calibration point shown in the table.
5. Store the new calibration constants (see [Storing the Calibration Constants](#)).

NOTE Each voltage and frequency takes approximately 2.5 seconds to complete.

Input		Instrument
Vrms	Frequency	Range
100 mV	5 kHz, 10 kHz, 20 kHz, 35 kHz, 50 kHz, 75 kHz, 100 kHz, 200 kHz, 300 kHz, 390 kHz, 400 kHz, 220 Hz, 1000 Hz	100 mV
1 V	5 kHz, 10 kHz, 20 kHz, 35 kHz, 50 kHz, 75 kHz, 100 kHz, 200 kHz, 300 kHz, 390 kHz, 400 kHz, 220 Hz, 1000 Hz	1 V
10 V	5 kHz, 10 kHz, 20 kHz, 35 kHz, 50 kHz, 75 kHz, 100 kHz, 200 kHz, 300 kHz, 390 kHz, 400 kHz, 220 Hz, 1000 Hz	10 V
50 V	5 kHz, 10 kHz, 20 kHz, 35 kHz, 50 kHz, 75 kHz, 100 kHz, 200 kHz, 300 kHz, 390 kHz, 400 kHz, 220 Hz, 1000 Hz	100 V
500 V	1000 Hz	750 V

[Next Procedure](#) 

AC Current Gain and Flatness Calibration

This calibration procedure applies to the 34460A and 34461A only.

Review [Test Considerations](#) and [Flatness Calibration Considerations](#) before performing any calibration.

Configuration: AC Current

All AC calibration procedures use the 3 Hz bandwidth measurement filter.

1. Select each range in the order shown in the table below.
2. Apply each input current and frequency shown in the Input columns.
3. Enter the actual applied input current as the Cal Value (see [Entering Calibration Values](#)). A Calibration Step Succeeded message indicates success; if the display shows Calibration Step Failed, check the input value, range, function, and entered calibration value and repeat the calibration step.
4. Repeat steps 1 through 3 for each frequency shown in the table.
5. Repeat steps 1 through 4 for each current range in the table.
6. Store the new calibration constants (see [Storing the Calibration Constants](#)).

NOTE Each current and frequency takes approximately 2.5 seconds to complete.

Input		Instrument
Current	Frequency	Range
1 A	5 kHz, 7.5 kHz, 9.7 kHz, 10 kHz, 220 Hz, 1 kHz	1 A
100 mA	5 kHz, 7.5 kHz, 9.7 kHz, 10 kHz, 220 Hz, 1 kHz	100 mA
10 mA	5 kHz, 7.5 kHz, 9.7 kHz, 10 kHz, 220 Hz, 1 kHz	10 mA
1 mA	1 kHz	1 mA
100 μ A	1 kHz	100 μ A

[Next Procedure](#)

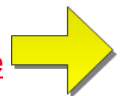

AC Zero Calibration

This calibration procedure applies to all models (34460A/61A/65A/70A).

Review [Test Considerations](#) before performing any calibration procedure.

Configuration: AC Voltage

1. Set the calibrator to 0.00 VAC.
2. Enter a calibration value of +0. (see [Entering Calibration Values](#)). A Calibration Step Succeeded message indicates success; if the display shows Calibration Step Failed, check the input value, range, function, and entered calibration value and repeat the calibration step.
3. Store the new calibration constants (see [Storing the Calibration Constants](#)).

NOTE

This calibration takes approximately 10 seconds to complete.

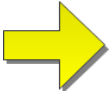
[Next Procedure](#) 

Frequency Accuracy Calibration

This calibration procedure applies to all models (34460A/61A/65A/70A).

Review [Test Considerations](#) and [Gain Calibration Considerations](#) before beginning this procedure.

Configuration: Frequency, 10 V range

NOTE The frequency accuracy of the Fluke 5720A is insufficient to calibrate the DMM. Its frequency output needs to be calibrated against a more accurate reference. The Keysight 33500B Series Function/Arbitrary Waveform Generator is recommended for this calibration procedure.

1. Configure the instrument for frequency measurements at 10 V and 10 kHz, with 1 second gate time.
2. Apply a 10 kHz sine wave between 9 and 11 Vrms.
3. Enter the actual applied input frequency (see [Entering Calibration Values](#)). A Calibration Step Succeeded message indicates success; if the display shows Calibration Step Failed, check the input value, range, function, and entered calibration value and repeat the calibration step.
4. Store the new calibration constants (see [Storing the Calibration Constants](#)).

NOTE This calibration takes approximately 1 second to complete.

[Next Procedure](#)

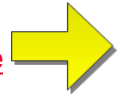

DC Voltage Gain Calibration

This calibration procedure applies to the 34460A and 34461A only.

Review [Test Considerations](#) and [Gain Calibration Considerations](#) before beginning this procedure.

Configuration: DC Voltage

1. Configure each function and range in the order shown in the table below.
2. Apply the input signal shown in the Input column.
3. Enter the actual applied input voltage amplitude (see [Entering Calibration Values](#)). A Calibration Step Succeeded message indicates success; if the display shows Calibration Step Failed, check the input value, range, function, and entered calibration value and repeat the calibration step.
4. Repeat steps 1 through 3 for each gain calibration point shown in the table.
5. Store the new calibration constants (see [Storing the Calibration Constants](#)).

NOTE Each range takes less than 4 seconds to complete.

Instrument Settings		
Input	Function	Range
10 V	DC Voltage	10 V
-10 V		10 V
0.1 V		100 mV
-0.1 V		100 mV
1 V		1 V
100 V		100 V
500 V		1000 V

[Next Procedure](#)

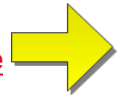

Ohms Gain Calibration

This calibration procedure applies to all models (34460A/61A/65A/70A).

Review [Test Considerations](#) and [Gain Calibration Considerations](#) before beginning this procedure.

Configuration: 4-Wire Ohms

This procedure adjusts the gain for the 2-wire and 4-wire Ohms functions, and the offset compensated Ohms function.

1. Configure each function and range in the order shown in the table below.
2. Apply the input signal shown in the Input column.
3. Enter the actual applied input resistance (see [Entering Calibration Values](#)). A Calibration Step Succeeded message indicates success; if the display shows Calibration Step Failed, check the input value, range, function, and entered calibration value and repeat the calibration step.
4. Repeat steps 1 through 3 for each gain calibration point shown in the table.
5. Store the new calibration constants (see [Storing the Calibration Constants](#)).

NOTE Each range takes less than 4 seconds to complete.

Instrument Settings		
Input	Function	Range
100 Ω	4-wire Ohms	100 Ω
1 k Ω		1 k Ω
10 k Ω		10 k Ω
100 k Ω		100 k Ω
1 M Ω		1 M Ω
10 M Ω		10 M Ω
100 M Ω	2-wire Ohms	100 M Ω

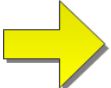
[Next Procedure](#) 

DC Current Gain Calibration

This calibration procedure applies to the 34460A and 34461A only.

Review [Test Considerations](#) and [Gain Calibration Considerations](#) before beginning this procedure.

Configuration: DC Current

1. Configure each function and range in the order shown in the table below.
2. Apply the input signal shown in the Input column.
3. Enter the actual applied input current as the Cal Value (see [Entering Calibration Values](#)). A Calibration Step Succeeded message indicates success; if the display shows Calibration Step Failed, check the input value, range, function, and entered calibration value and repeat the calibration step.
4. Repeat steps 1 through 3 for each gain calibration point shown in the table.
5. Store the new calibration constants (see [Storing the Calibration Constants](#)).

NOTE Each range takes less than 4 seconds to complete.

Instrument Settings		
Input	Function	Range
100 μ A	DC Current	100 μ A
1 mA		1 mA
10 mA		10 mA
100 mA		100 mA
1 A		1 A

[Next Procedure](#)

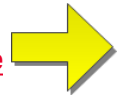

AC Current 10 A Gain Calibration

This calibration procedure applies to the 34461A, 34465A, and 34470A only (not applicable to the 34460A).

Review [Test Considerations](#) and [Flatness Calibration Considerations](#) before performing any calibration.

Configuration: AC Current

All AC calibration procedures use the 3 Hz bandwidth measurement filter.

1. Select the 10 A range.
2. Apply the 5 A input signal at 1000 Hz.
3. Enter the actual applied input current as the Cal Value (see [Entering Calibration Values](#)). A Calibration Step Succeeded message indicates success; if the display shows Calibration Step Failed, check the input value, range, function, and entered calibration value and repeat the calibration step.
4. Store the new calibration constants (see [Storing the Calibration Constants](#)).

NOTE

This calibration takes approximately 2.5 seconds to complete.

[Next Procedure](#)

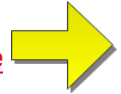

DC Current 10 A Gain Calibration

This calibration procedure applies to the 34461A, 34465A, and 34470A only (not applicable to the 34460A).

Review [Test Considerations](#) and [Flatness Calibration Considerations](#) before performing any calibration.

Configuration: DC Current

1. Configure the 10 A range and set the integration time to 100 PLC.
2. Apply the 5 A input.
3. Enter the actual applied input current as the Cal Value (see [Entering Calibration Values](#)). A Calibration Step Succeeded message indicates success; if the display shows Calibration Step Failed, check the input value, range, function, and entered calibration value and repeat the calibration step.
4. Store the new calibration constants (see [Storing the Calibration Constants](#)).

NOTE This calibration takes less than 4 seconds to complete.

[Next Procedure](#)



Capacitance Offset Calibration (Optional)

This calibration procedure applies to all models (34460A/61A/65A/70A).

This calibration is normally not required. It compensates for residual capacitance offset which is typically less than a few pF. In normal use, any residual offset will be overridden by the null function (null also corrects for cable capacitance), and the null function is required to achieve the multimeter's capacitance specification.

Configuration: Capacitance

1. Remove all connections from the instrument's front terminals.
2. Select the front terminals.
3. Enter a calibration value of +0 (see [Entering Calibration Values](#)). A Calibration Step Succeeded message indicates success; if the display shows Calibration Step Failed, check the input value, range, function, and entered calibration value and repeat the calibration step.
4. Repeat steps 1 through 3 for the instrument's rear terminals (not applicable to the 34460A).
5. Store the new calibration constants (see [Storing the Calibration Constants](#)).

[Next Procedure](#)

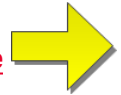

Finishing Calibration

To finish calibrating your instrument:

1. Remove all shorting blocks and connections from the instrument.
2. Reset the [calibration message](#).
3. [Secure the instrument](#) with the calibration password.
4. Record the [new calibration count](#).
5. Perform the [performance verification tests](#) to verify the calibration.

34465A and 34470A Calibration Procedures

The following calibration procedures apply only to the 34465A and 34470A DMMs. Perform the calibration procedures in the order listed in this document. Use the arrow links at the bottom of every page to go to the next calibration procedure.

1. [ADC and Zero Calibration](#)
2. [AC Voltage Low Frequency Gain and Flatness Calibration](#)
3. [AC Voltage Gain and Flatness Calibration](#)
4. [AC Current Gain and Flatness Calibration](#)
5. [AC Zero Calibration](#)
6. [Frequency Accuracy Calibration](#)
7. [DC Voltage Gain Calibration](#)
8. [Ohms Gain Calibration](#)
9. [DC Current Gain Calibration](#)
10. [AC Current 10 A Gain Calibration](#)
11. [DC Current 10 A Gain Calibration](#)
12. [DC High Voltage Gain Calibration](#)
13. [Capacitance Offset Calibration \(Optional\)](#)
14. [Finishing Calibration](#)

[First Procedure](#) 

ADC and Zero Calibration

Each time you perform a zero calibration, the instrument stores a new set of offset correction constants for every measurement function and range. The instrument sequences through all required functions and ranges automatically and stores new zero offset calibration constants. All offset corrections are determined automatically. You may not correct a single range or function without re-entering ALL zero offset correction constants automatically. This feature is intended to save calibration time and improve zero calibration consistency.

CAUTION Never turn off the instrument during Zero Calibration. This may cause ALL calibration memory to be lost.

ADC and DC Zero Calibration Procedure

This calibration procedure applies to all models (34460A/61A/65A/70A).

Be sure to allow the instrument to warm up and stabilize for 90 minutes before performing the calibration.

1. Follow the steps outlined below. Review [Test Considerations](#) before beginning this test.
2. This procedure uses a low-thermal shorting block installed on the input connectors.

NOTE For the 34461A/65A/70A, two shorting blocks are recommended; one on the front panel and one on the rear panel. A single shorting block can be used with the 34460A.

3. Select the front panel input terminals. Install a shorting block on the front panel input terminals.
4. Select the ADC calibration mode ([Utility] > Test/Admin > Calibrate > Perform Cal > Perform ADC Cal).
5. The display will show a message indicating that ADC calibration is in process. It will then display the results of the ADC calibration. A Calibration Step Succeeded message indicates success; if the display shows Calibration Step Failed, check the input value, range, function, and entered calibration value and repeat the calibration step. Press **Save Cal Values**.
6. Select the DCV measurement function. Enter a calibration value of +0.
7. Press [Utility] > Test/Admin > Calibrate > Perform Cal > Perform Cal Step.
8. The Zero Calibration lasts approximately two minutes. A Calibration Step Succeeded message indicates success; if the display shows Calibration Step Failed, check the input value, range, function, and entered calibration value and repeat the calibration step.
9. Press **Save Cal Values**.
10. Select the rear input terminals. Install a shorting block rear-panel input terminals.
11. Repeat steps 4 through 9 for the rear input terminals.
12. Store the new ADC and Zero calibration constants (see Storing the Calibration Constants).

NOTE The following gain and flatness calibration procedures can be done using either the front or rear terminals (rear terminals not available on the 34460A). On the 34461A/65A/70A, make sure the **Front/Rear** switch matches the terminals in use.

[Next Procedure](#) 

AC Voltage Low Frequency Gain and Flatness Calibration

This calibration procedure applies to all models (34460A/61A/65A/70A).

Review [Test Considerations](#) and [Flatness Calibration Considerations](#) before performing any calibration.

Configuration: AC Voltage

1. Configure the range shown in the table below.
2. Apply the input signal shown in the Input column.
3. Enter the actual applied input voltage amplitude (see [Entering Calibration Values](#)). A Calibration Step Succeeded message indicates success; if the display shows Calibration Step Failed, check the input value, range, function, and entered calibration value and repeat the calibration step.
4. Repeat steps 1 through 3 for each flatness calibration point shown in the table.
5. Store the new calibration constants (see [Storing the Calibration Constants](#)).

NOTE Each voltage and frequency takes approximately 2.5 seconds to complete.

Input		Instrument
Vrms	Frequency	Range
7 V	10 Hz	10 V
7 V	40 Hz	10 V

[Next Procedure](#)



AC Voltage Gain and Flatness Calibration

This calibration procedure applies to all models (34460A/61A/65A/70A).

Review [Test Considerations](#) and [Flatness Calibration Considerations](#) before performing any calibration.

Configuration: AC Voltage

All AC calibration procedures use the 3 Hz bandwidth measurement filter.

1. Configure each function and range in the order shown in the table below.
2. Apply the input signal shown in the Input column.
3. Enter the actual applied input voltage amplitude (see [Entering Calibration Values](#)). A Calibration Step Succeeded message indicates success; if the display shows Calibration Step Failed, check the input value, range, function, and entered calibration value and repeat the calibration step.
4. Repeat steps 1 through 3 for each flatness calibration point shown in the table.
5. Store the new calibration constants (see [Storing the Calibration Constants](#)).

NOTE Each voltage and frequency takes approximately 2.5 seconds to complete.

Input		Instrument
Vrms	Frequency	Range
100 mV	5 kHz, 10 kHz, 20 kHz, 35 kHz, 50 kHz, 75 kHz, 100 kHz, 200 kHz, 300 kHz, 390 kHz, 400 kHz, 220 Hz, 1000 Hz	100 mV
1 v	5 kHz, 10 kHz, 20 kHz, 35 kHz, 50 kHz, 75 kHz, 100 kHz, 200 kHz, 300 kHz, 390 kHz, 400 kHz, 220 Hz, 1000 Hz	1 V
10 V	5 kHz, 10 kHz, 20 kHz, 35 kHz, 50 kHz, 75 kHz, 100 kHz, 200 kHz, 300 kHz, 390 kHz, 400 kHz, 220 Hz, 1000 Hz	10 V
50 V	5 kHz, 10 kHz, 20 kHz, 35 kHz, 50 kHz, 75 kHz, 100 kHz, 200 kHz, 300 kHz, 390 kHz, 400 kHz, 220 Hz, 1000 Hz	100 V
500 V	1000 Hz	750 V

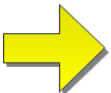
[Next Procedure](#) 

AC Current Gain and Flatness Calibration

This calibration procedure applies to the 34465A and 34470A only.

Review [Test Considerations](#) and [Flatness Calibration Considerations](#) before performing any calibration.

Configuration: AC Current

All AC calibration procedures use the 3 Hz bandwidth measurement filter.

1. Select each range in the order shown in the table below.
2. Apply each input current and frequency shown in the Input columns.
3. Enter the actual applied input current as the Cal Value (see [Entering Calibration Values](#)). A Calibration Step Succeeded message indicates success; if the display shows Calibration Step Failed, check the input value, range, function, and entered calibration value and repeat the calibration step.
4. Repeat steps 1 through 3 for each frequency shown in the table.
5. Repeat steps 1 through 4 for each current range in the table.
6. Store the new calibration constants (see [Storing the Calibration Constants](#)).

NOTE Each current and frequency takes approximately 2.5 seconds to complete.

Input		Instrument
Current	Frequency	Range
1.5 A	5 kHz, 7.5 kHz, 9.7 kHz, 10 kHz, 220 Hz, 1 kHz	3 A
1 A	5 kHz, 7.5 kHz, 9.7 kHz, 10 kHz, 220 Hz, 1 kHz	1 A
100 mA	5 kHz, 7.5 kHz, 9.7 kHz, 10 kHz, 220 Hz, 1 kHz	100 mA
10 mA	5 kHz, 7.5 kHz, 9.7 kHz, 10 kHz, 220 Hz, 1 kHz	10 mA
1 mA	5 kHz, 7.5 kHz, 9.7 kHz, 10 kHz, 220 Hz, 1 kHz	1 mA
100 μ A	5 kHz, 7.5 kHz, 9.7 kHz, 10 kHz, 220 Hz, 1 kHz	100 μ A

[Next Procedure](#)

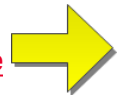

AC Zero Calibration

This calibration procedure applies to all models (34460A/61A/65A/70A).

Review [Test Considerations](#) before performing any calibration procedure.

Configuration: AC Voltage

1. Set the calibrator to 0.00 VAC.
2. Enter a calibration value of +0. (see [Entering Calibration Values](#)). A Calibration Step Succeeded message indicates success; if the display shows Calibration Step Failed, check the input value, range, function, and entered calibration value and repeat the calibration step.
3. Store the new calibration constants (see [Storing the Calibration Constants](#)).

NOTE

This calibration takes approximately 10 seconds to complete.

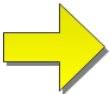
[Next Procedure](#) 

Frequency Accuracy Calibration

This calibration procedure applies to all models (34460A/61A/65A/70A).

Review [Test Considerations](#) and [Gain Calibration Considerations](#) before beginning this procedure.

Configuration: Frequency, 10 V range

NOTE The frequency accuracy of the Fluke 5720A is insufficient to calibrate the DMM. Its frequency output needs to be calibrated against a more accurate reference. The Keysight 33500B Series Function/Arbitrary Waveform Generator is recommended for this calibration procedure.

1. Configure the instrument for frequency measurements at 10 V and 10 kHz, with 1 second gate time.
2. Apply a 10 kHz sine wave between 9 and 11 Vrms.
3. Enter the actual applied input frequency (see [Entering Calibration Values](#)). A Calibration Step Succeeded message indicates success; if the display shows Calibration Step Failed, check the input value, range, function, and entered calibration value and repeat the calibration step.
4. Store the new calibration constants (see [Storing the Calibration Constants](#)).

NOTE This calibration takes approximately 1 second to complete.

[Next Procedure](#) 

DC Voltage Gain Calibration

This calibration procedure applies to the 34465A and 34470A only.

Review [Test Considerations](#) and [Gain Calibration Considerations](#) before beginning this procedure.

Configuration: DC Voltage

1. Configure each function and range in the order shown in the table below.
2. Apply the input signal shown in the Input column.
3. Enter the actual applied input voltage amplitude (see [Entering Calibration Values](#)). A Calibration Step Succeeded message indicates success; if the display shows Calibration Step Failed, check the input value, range, function, and entered calibration value and repeat the calibration step.
4. Repeat steps 1 through 3 for each gain calibration point shown in the table.
5. Store the new calibration constants (see [Storing the Calibration Constants](#)).

NOTE Each range takes less than 4 seconds to complete.

Instrument Settings		
Input	Function	Range
10 V	DCV	10 V
-10 V		10 V
0.1 V		100 mV
-0.1 V		100 mV
1 V		1 V

NOTE The 100V and 1000V ranges are adjusted later in the [DC Voltage High Voltage Gain Calibration](#).

[Next Procedure](#)

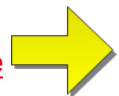

Ohms Gain Calibration

This calibration procedure applies to all models (34460A/61A/65A/70A).

Review [Test Considerations](#) and [Gain Calibration Considerations](#) before beginning this procedure.

Configuration: 4-Wire Ohms

This procedure adjusts the gain for the 2-wire and 4-wire Ohms functions, and the offset compensated Ohms function.

1. Configure each function and range in the order shown in the table below.
2. Apply the input signal shown in the Input column.
3. Enter the actual applied input resistance (see [Entering Calibration Values](#)). A Calibration Step Succeeded message indicates success; if the display shows Calibration Step Failed, check the input value, range, function, and entered calibration value and repeat the calibration step.
4. Repeat steps 1 through 3 for each gain calibration point shown in the table.
5. Store the new calibration constants (see [Storing the Calibration Constants](#)).

NOTE Each range takes less than 4 seconds to complete.

Instrument Settings		
Input	Function	Range
100 Ω	4-wire Ohms	100 Ω
1 k Ω		1 k Ω
10 k Ω		10 k Ω
100 k Ω		100 k Ω
1 M Ω		1 M Ω
10 M Ω		10 M Ω
100 M Ω	2-wire Ohms	100 M Ω

[Next Procedure](#) 

DC Current Gain Calibration

This calibration procedure applies to the 34465A and 34470A only.

Review [Test Considerations](#) and [Gain Calibration Considerations](#) before beginning this procedure.

Configuration: DC Current

1. Configure each function and range in the order shown in the table below.
2. Apply the input signal shown in the Input column.
3. Enter the actual applied input current as the Cal Value (see [Entering Calibration Values](#)). A Calibration Step Succeeded message indicates success; if the display shows Calibration Step Failed, check the input value, range, function, and entered calibration value and repeat the calibration step.
4. Repeat steps 1 through 3 for each gain calibration point shown in the table.
5. Store the new calibration constants (see [Storing the Calibration Constants](#)).

NOTE Each range takes less than 4 seconds to complete.

Instrument Settings		
Input	Function	Range
1 mA	DC Current	1 mA
10 mA		10 mA
100 mA		100 mA
1 A		1 A
2 A		3 A

[Next Procedure](#)

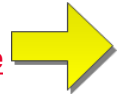

DC High Voltage Gain Calibration

This calibration procedure applies to the 34465A and 34470A only.

Review [Test Considerations](#) and [Gain Calibration Considerations](#) before beginning this procedure.

Configuration: DC Voltage

1. Configure each function and range in the order shown in the table below.
2. Apply the input signal shown in the Input column.
3. Enter the actual applied input voltage amplitude (see [Entering Calibration Values](#)). A Calibration Step Succeeded message indicates success; if the display shows Calibration Step Failed, check the input value, range, function, and entered calibration value and repeat the calibration step.
4. Repeat steps 1 through 3 for each gain calibration point shown in the table.
5. Store the new calibration constants (see [Storing the Calibration Constants](#)).

NOTE Each range takes less than 4 seconds to complete.

Instrument Settings		
Input	Function	Range
100 V	DC Voltage	100 V
500 V		1000 V

[Next Procedure](#)



AC Current 10 A Gain Calibration

This calibration procedure applies to the 34461A, 34465A, and 34470A only (not applicable to the 34460A).

Review [Test Considerations](#) and [Flatness Calibration Considerations](#) before performing any calibration.

Configuration: AC Current

All AC calibration procedures use the 3 Hz bandwidth measurement filter.

1. Select the 10 A range.
2. Apply the 5 A input signal at 1000 Hz.
3. Enter the actual applied input current as the Cal Value (see [Entering Calibration Values](#)). A Calibration Step Succeeded message indicates success; if the display shows Calibration Step Failed, check the input value, range, function, and entered calibration value and repeat the calibration step.
4. Store the new calibration constants (see [Storing the Calibration Constants](#)).

NOTE

This calibration takes approximately 2.5 seconds to complete.

[Next Procedure](#)



DC Current 10 A Gain Calibration

This calibration procedure applies to the 34461A, 34465A, and 34470A only (not applicable to the 34460A).

Review [Test Considerations](#) and [Flatness Calibration Considerations](#) before performing any calibration.

Configuration: DC Current

1. Configure the 10 A range and set the integration time to 100 PLC.
2. Apply the 5 A input.
3. Enter the actual applied input current as the Cal Value (see [Entering Calibration Values](#)). A Calibration Step Succeeded message indicates success; if the display shows Calibration Step Failed, check the input value, range, function, and entered calibration value and repeat the calibration step.
4. Store the new calibration constants (see [Storing the Calibration Constants](#)).

NOTE This calibration takes less than 4 seconds to complete.

[Next Procedure](#) 

Capacitance Offset Calibration (Optional)

This calibration procedure applies to all models (34460A/61A/65A/70A).

This calibration is normally not required. It compensates for residual capacitance offset which is typically less than a few pF. In normal use, any residual offset will be overridden by the null function (null also corrects for cable capacitance), and the null function is required to achieve the multimeter's capacitance specification.

Configuration: Capacitance

1. Remove all connections from the instrument's front terminals.
2. Select the front terminals.
3. Enter a calibration value of +0 (see [Entering Calibration Values](#)). A Calibration Step Succeeded message indicates success; if the display shows Calibration Step Failed, check the input value, range, function, and entered calibration value and repeat the calibration step.
4. Repeat steps 1 through 3 for the instrument's rear terminals (not applicable to the 34460A).
5. Store the new calibration constants (see [Storing the Calibration Constants](#)).

[Next Procedure](#)

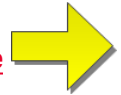

Finishing Calibration

To finish calibrating your instrument:

1. Remove all shorting blocks and connections from the instrument.
2. Reset the [calibration message](#).
3. [Secure the instrument](#) with the calibration password.
4. Record the [new calibration count](#).
5. Perform the [performance verification tests](#) to verify the calibration.

Index

*

*CAL? 269

*CLS 269

*ESE 270

*ESR? 271

*IDN? 272

*LRN? 274

*OPC 274

*OPC? 275

*OPT? 275

*PSC 276

*PSC? 276

*RST 277

*SAV 276

*SRE 277

*STB? 278

*TRG 278

*TST? 279

*WAI 279

2

2-wire measurements 349-350, 355

2-wire Resistance 253, 316, 356-358

2-Wire Resistance 68

2-wire RTD 254

2-Wire vs. 4-Wire Measurements 175

3

34460A and 34461A adjustments 541

34461A adjustments 541

34465A and 34470A Adjustments 556

34470A adjustments 556

34470A and 34465A adjustments 556

4

4-wire Resistance 253, 316, 356-358

4-Wire Resistance 68

4-wire RTD 254, 364

A

ABORt 204

About Digitizing Mode 181

AC 250, 255, 287, 292, 323-330, 376-382

AC Current 66, 316, 328-329

AC current flatness 546, 561

AC Current Measurement Errors (Burden Voltage) 193

AC current verification 517, 522

AC Voltage 62, 255, 316, 380-381

AC voltage verification 517

AC Zero Calibration 547, 562

ACALibration 396-397

ACI 66

acquiring readings 97

ACV 62

ADC 240, 542, 557
ADDRess 409
ADJust 371
adjustments 524, 530-531, 542, 555, 557, 571
Admin 150
Aliasing 180
ALL 211, 221, 233, 241, 296, 425
APERture 330, 340, 349-350, 362, 382
APERture Enabled 383
APERture ENABled 331, 362
ASCII String Parameters 201
AUTO 200, 223, 229, 248, 253, 255, 257, 285, 302-303, 319, 326, 328-329, 335, 342, 346, 354, 357, 360, 365, 374, 379, 381, 384, 388, 432
Autocal command 269
Autocalibration 141
Automatic input impedance 384
automatic trigger delays 457
Autorange 248, 253, 255, 257, 285, 357, 381
Autozero 313, 335, 360, 388
Autozero On/Off 176
AVERage 215, 233, 235
Average, moving 237-238

B

BANDwidth 323, 376

Bar Meter 123
battery 493
BEEPer 397-398
BMP 266
Boolean Parameters 201
BORDER 264
Burden Voltage 193
BUS 201, 435

C

CALCulate 215, 217-219, 221-231, 233, 235, 237-238
 AVERage Subsystem 232
 histogram 221-224
 HISTogram Subsystem 220
 LIMit Subsystem 216
 SCALe Subsystem 225
 scaling 231
 smoothing 237-238
 TCHart
 STATe 239
CALCulate Subsystem Introduction 213
calibration 507, 511, 516-517, 522, 524-525, 529-534, 542, 546, 555, 557, 561, 571
CALibration 240-245, 447
calibration adjustments 531
calibration count 534
Calibration Errors 461

CALibration Subsystem 240
Capacitance 78
CAPacitance 248, 285, 317-321
Capacitance Measurement
 Considerations 179
Capacitance Offset Calibration (Optional)
 554, 570
Capacitance Theory 178
Capacitance Verification (Optional Veri-
 fication Test) 523
Carrying Handle 42
CATalog 296, 424
CD-ROM 197
CDIRectory 297
celsius 370, 372
Characteristics 330, 349, 362, 382
Chart 126
CHECK 370
CLEar 222
CLEAr 215, 217, 235, 263
CLICK 398
CLS 200, 269
CODE 242
Command Errors 461
Command Quick Reference 436
Command Separators 199
Command Summary 246, 264, 283, 309
Commands by Subsystem 202

Common Mode Errors 194
COMMunicate 408-417, 419
CONDition 392-393
CONFigure 248-255, 257
Configure I/O 147
CONFigure Subsystem 246
CONFigure? 248
configuring remote interface 29, 34
contacting Keysight 37
Continuity 79
CONTInuity 249, 286, 316
CONTInuous 336
Continuous Mode 49
CONTRol 410
COPY 297
count 534
COUNT 222, 233, 241, 309-310, 403,
 426, 430
CSEParator 306
CURRent 250, 287, 316, 323-336
current fuse replacement 495
current verification 517
Current, DC 64

D
DATA 218, 221, 259-261, 264, 266, 306,
 308
Data Log and Digitize Mode Default Set-
 tings 50

Data Log Mode 49, 83, 184

Data Log Mode Features 184

Data Logging 83

Data Logging Local/Remote Interaction 183, 189

Data Logging, Trend Chart 129

DATA Subsystem 259

DATA2 337

DATE 399

DATE? 242, 396

DB 225

dB Scaling 105

DBM 226

dBm Scaling 105

DC 250, 257, 287, 292-293, 296, 324-335, 377, 378-379, 382-388

DC Current 64, 174, 316, 333, 335

DC Current Gain Calibration 551, 566

DC current verification 522

DC measurements 456

DC Voltage 59, 316, 384-386, 388

DC voltage measurements 59

DCI 64

DCV measurements 59

DCV tutorial 59

DEFault 199

Default Settings 246, 283, 475

DElay 311, 431-432

Delay, trigger 99

delays, trigger 457

DElete 298, 425

DESCription 425

DESired 281

Device-Specific Errors 461

Device Clear 202, 410

DHCP 410

Digitize Mode 49, 88

Digitizing 88

Digitizing Local/Remote Interaction 183, 189

Digitizing Measurements 180

Digitizing Mode 181

Digitizing, Trend Chart 129

Diode 80

DIODe 251, 288, 316

disassembly 489

Discrete Parameters 201

DISPlay 201, 262-263

Display Bar Meter 123

Display Histogram 135

Display Introduction 116

Display Number 118

DISPlay Subsystem Introduction 262

Display Trend Chart (Continuous Mode) 126

Distributor installed options 27

dmm 370, 372

DNS 411

DOMain 411

DOWNload 306

Drivers 197

E

ENABle 280, 392, 394, 408, 420

End-Or-Identify 200

ERRor 400, 426

Error Messages 461

Error Queue 461

Errors in High Resistance
Measurements 169

ESE 200, 270

ESR? 271

Estimating High-Frequency (Out-of-
Band) Error 172

EVENT 260-261, 393-394

Event Status Enable 276

Execute SAMPlE 313

Execution Error 461

Ext Trig BNC 435

EXTernal 201, 435

F

Factory installed options 27

Factory Reset 264, 277, 311-312, 314,
317-318, 330, 349, 362, 382, 399,
405, 475

Factory Settings 475

FAST 237, 336

features 48

FETCh? 205

Files, Manage 145

finishing adjustments 555, 571

firmware update 36

flatness 546, 561

flatness adjustments 530

flatness calibration 546, 561

FNAME 306

FORMat 264, 266, 306-307

FORMat Subsystem 264

Frequency 81

FREQuency 252, 289, 316, 340-347

Frequency and Period Measurement
Errors Frequency and Period Meas-
urement Errors Frequency and
Period Measurement Errors 174

frequency gain verification 516

FRESistance 253, 290, 316, 349-359

FRONt 210

Front and rear terminals 210

front panel 25

Front panel keys 52

Front panel menu reference 52

FRTD 254, 291, 368-369

FTHermistor 373

FUNction 226, 316

functions 48

fuse replacement 495

G

GAIN 227-228

gain adjustment 529-530

gain verification 511, 516

GATeway 412

GPIB 197, 409

GPIB option 498

Ground Loops, Noise 167

H

Handle 42

HCOPY 266

HCOPY Subsystem 266

Help 43

HELP 401

Help system 43

HI-Z 384

High-Voltage Self-Heating Errors 193

High-Frequency (Out-of-Band)
Error 172

High-Frequency Signal Content and True
RMS Accuracy 171

High-Speed AC Measurements 176

High-Speed DC and Resistance Meas-
urements 177

High Resistance Measurement Errors 169

Histogram 135

HISTogram 221-224

HNAME 281

hold readings 102

HOST 420

HOSTname 413

How Sample Rate/Interval is
Determined 196

HP34401A 402

I

I/O Configuration 147

LAN 425, 427

IDENTify 280, 402

IDN? 272

IEEE 488.2 Commands 200, 274

IEEE 488.2 Common Commands 267

IMMediate 201, 206, 215, 217, 235, 397,
404, 435

IMPedance 384

INFormation 307

INITiate 206

Input impedance 384

Input terminal measurement limits 19

INSTall 427

Instrument Errors 461

Instrument Preset 264, 311, 314, 399,
405, 475

integration table 456
integration time 456
INternal 432, 435
internal DMM 370
internal fuse replacement 495
Interval and Sample Rate 196
Introduction to instrument 24
Introduction to the SCPI Language 198
IPADdress 414

K

Keysight 37
Keysight IO Libraries Suite 197

L

LABel 403
LAN 410-417, 419
 configuring 281
LAN configuration 29
LAN Configuration 34
LAST 259
Leakage Current Errors 195
Learn String 274
LEVel 432
Level Triggering 181
Level Triggering Details 93, 190
LICense 424-427
LIMit 217-219, 444

Limits 112
Limits, measurement 19
Line Noise Voltages, Rejecting 166
LOAD 301-302
Loading Errors (AC volts) 192
Loading Errors (DC Voltage) 165
Local key 262
Local/Remote Interaction 183, 189
LOCK 422-423
Low-Power 356, 368-369
Low-Level Measurement Errors 194
LOWer 218, 223, 343
LPOWer 356, 369
LRN 274
LXI 280-282
LXI Subsystem 280

M

MAC 414
Magnetic Loops, Noise 166
Making High-Speed AC
 Measurements 176
Making High-Speed DC and Resistance
 Measurements 177
Manage Files 145
Master Summary 278
Math Functions 230
Math Introduction 103

Math Limits 112
Math Null 104
Math Scaling 107
Math Smoothing 110
Math Statistics 111
MAXimum 199, 233
Maximum limits 19
MDIRectory 297
MDNS 280-281
MEASure 285-293, 436
MEASure Subsystem 283
Measurement Considerations 163
Measurement Considerations, Capacitance 179
Measurement limits 19
Measurement Tutorial 162
Measurements 58
Measurements Below Full Scale 193
MEDium 237
Menu reference 52
Minimizing Power Dissipation Effects 169
MINimum 199, 233
MMEMory 296-298, 301-303, 306-308, 399, 405
MMEMory Subsystem - Data Transfer Commands 304
MMEMory Subsystem - General Purpose File Management 294

MMEMory Subsystem - STATe and PREFerence Files 299
MODE 336
Models and options 27
MOVE 298
Mx-B Scaling 230

N

NAME 422
NEGative 207, 434
NEXT 400
Noise Caused by Ground Loops 167
Noise Caused by Magnetic Loops 166
Noise Rejection 166
Nonvolatile Memory 384, 420
Notices, safety 14
NPLC 330, 332, 349, 351, 362-363, 382, 385
Null 104
NULL 317-319, 324-326, 341-342, 352-354, 364-365, 377-379
NULL Reading 176
Number 310
 pretrigger 310
Numeric Parameters 200
Nyquist Rate 180

O

OCOMPensated 355, 367

OFF
 autoranging 319
ONCE 328-329, 335, 357, 360, 374, 381,
 388
OPC 200, 274-275
OPC? 275
OPERation 392-393
OPT? 275
Options and models 27
Out-of-Band Error 172
OUTPut 207
OWNer 422

P

Parameter Settings 199
Parts, Replaceable 488
password 532
Performance Verification Tests 504
Period 81
PERiod 289, 316, 340-347
Period and Frequency Measurement
 Errors 174
PLC 330, 349, 362, 382, 385, 454
PNG 266
POINts 222, 259-260
POSitive 207, 434
power-on self-test 487
Power-On Status Clear 276

Power-on/reset 475
Power Dissipation Effects, Minimizing 169
power supplies 480
Power supply voltages 483
PREferences 301
Preferences Store and Recall 143
PRESet 311, 393, 399, 403, 405, 475
PRETrigger 310
Probe Hold 102
Probe Type Choice, Temperature 175
PROMpt 416
PSC 276, 392, 394
PTPeak 233

Q

Query Errors 461
Querying 199
QUEStionable 393-394
Questionable Data Register 276
Quick Reference 436

R

R? 208
rack 46
rack mount 46
range 454
RANGe 223, 319-320, 327-328, 343,
 345-346, 356-357, 380-381
range table 454

RATIo 257, 293, 316, 386
 RCL 276
 RDG_STORE 308
 RDIRectory 297
 READ? 209
 READing 306-307
 reading acquisition 97
 readings 97
 REAR 210
 rear panel 26
 RECall 302-303
 REFerence 225-226, 229, 368
 Rejecting Power-Line Noise Voltages 166
 RELease 422
 remote interface 29
 REMOve 261
 Removing Test Lead Resistance
 Errors 168
 repair 478, 528, 535, 544-545, 548-550,
 552-553, 559-560, 563-565, 567-
 569
 Replaceable Parts 488
 replacing fuses 495
 REQuest 423
 RESet 282
 Reset state 475
 Resistance 68
 RESistance 253, 290, 316, 351-360, 368
 Resistance Measurement
 Considerations 168
 resolution 454
 RESolution 333, 358, 362, 386
 resolution table 454, 456
 RESolved 281
 RESPonse 237
 RESTart 282
 Return Format 313
 Returns 320
 autoranging 319
 pretrigger 310
 RJUNction 371
 RLIMit 307
 ROUTe 210
 Row limit 307
 RST 200, 277, 399, 405
 RTD 254, 291, 364, 368-369, 373

S

 Safety information 12
 Safety notices 14
 Safety symbols 14
 SAMPlE 309-311, 313
 Sample Rate and Interval 196
 SAMPlE Subsystem Introduction 309
 SAV 276
 SCALe 225-231

Scaling 107, 231, 445

- function 316, 324-326, 341-342, 352-354, 364
- reference 257, 293
- units 231

Scaling, dB/dBM 105

SCPI Command Terminators 200

SCPI Parameter Types 200

SDEVIation 233

SDUMp 266

SECOndary 330, 334, 347, 366, 382, 386-387

Secondary Measurements 95

SECOndary, CAPacitance 321, 359

SECure 242-243

security 532

SECurity 403-404

security code override 500, 536

SELEct 303

Self-Heating Errors 193

self-test 487

Self-test 279

Self-Test Errors 461

SENSe 316-321, 323-336, 340-347, 349-360, 362-371, 373-374, 376-388

- {FREQuency|PERiod} Subsystem 339
- {RESistance|FRESistance} Subsystem 348

CURRent Subsystem 322

DATA2 Subsystem 337

DATA2? 337

TEMPerature Subsystem 361

VOLTage Subsystem 375

SENSe Subsystem Introduction 316

Serial Poll 278

service 478, 528, 535, 544-545, 548-550, 552-553, 559-560, 563-565, 567-569

Service Request 410

- enable 393

Settling Time Effects 192

Setup, System 152

SLOPe 207, 434

SLOW 237

SMASK 415

Smoothing 110

SMOothing 237-238

SNAME 281

SOURce 311, 432, 435

SRE 277

Standard Event Register 276

Standard Operation Register 276

STATe 219, 224, 230-231, 235, 238, 243, 280, 302-303, 317-319, 324, 341, 352, 364, 377, 398

State Store and Recall 143

Statistical functions
 maximum value 199
 minimum value 199
 Statistics 111
 STATus 392-394
 Status Byte Register 276
 STATus Subsystem 389
 STB? 278
 STORe 243, 301-302, 308
 STRing 244
 support 37
 SWITCh 336
 Symbols, safety 14
 Syntax Conventions 198
 SYSTem 397-406, 408-417, 419-420, 422-427
 LICense Subsystem 424
 LOCK Subsystem 421
 System Setup 152
 SYSTem Subsystem - General Purpose
 Commands 395
 SYSTem Subsystem - IO
 Configuration 407

T

taking readings 97
 TELNet 416-417
 TEMP? 244, 396
 TEMPerature 201, 212, 254, 291, 362-371, 373-374, 404
 Temperature (34460 and 34461A) 71
 Temperature (34465A and 34470A) 73
 Temperature Measurements 175
 Temperature Probe Type Choice 175
 TERMinals 210, 329
 TEST 211
 Test Lead Resistance Errors,
 Removing 168
 Test/Admin 150
 TEXT 201, 262-263
 The Sampling Rate 180
 Thermal EMF Errors 165
 THERmistor 369, 373
 thermocouple 370, 372-373
 thermocouple type 373
 THReshold 260-261
 TIME 405
 TIME? 244, 397
 TIMEout 344
 TIMer 313
 set 313
 TRANsducer 368-369, 373
 TRANSform 221-224
 Trend Chart (Continuous Mode) 126
 Trend Chart (Digitizing and Data Logging Modes) 129

TRG 278
TRIG 432
Trigger 309, 311, 432
TRIGger 207, 430-432, 434-435
Trigger delay 99
Trigger Delay 431
trigger delays 457
TRIGger Subsystem 429
triggering 97
Troubleshooting 483
True RMS AC Measurements 170
True RMS Accuracy and High-Frequency
Signal Content 171
TST? 279
TYPE 369

U

UNIT 200, 212, 230-231
units 371-372
Unnecessary Signal Errors 195
UPDate 417
updating firmware 36
UPLoad 308
UPPer 218, 223, 320, 327, 345, 356, 380
UPTime 405
USB flash drive 420
User installed options 27
Utility Menu 140

Utility, Store and Recall 143

V

VALid 303
VALue 245, 318-319, 325-326, 342,
353-354, 364-365, 378-379
verification 511, 516-517, 522
Verification Tests 504
VERSion 405
VIEW 263
VM Comp Output (BNC) 460
VOLTage 255, 257, 292-293, 345-346,
376-388
voltage verification 517
Voltmeter Complete 460

W

WAI 279
Wait-for-trigger 278, 311-312, 314
Web Interface 155, 197
Web UI 155
WINS 419
WMESsage 406, 417

Z

ZERO 335, 360, 374, 388
zero offset verification 507

© Keysight Technologies, Inc. 2013 - 2015

All rights reserved

Part Number: 34460-90901

Printed in Malaysia February 2015 Edition 2

