

# SKiiP 25NEB066V1



MiniSKiiP<sup>®</sup>2

1- phase bridge rectifier +  
brake chopper + 3-phase  
bridge inverter  
SKiiP 25NEB066V1

## Features

- Trench IGBTs
- Robust and soft freewheeling diodes in CAL technology
- Highly reliable spring contacts for electrical connections
- UL recognised file no. E63532

## Typical Applications\*

- Inverter up to 10 kVA
- Typical motor power 4,0 kW

## Remarks

- Case temperature limited to  $T_C = 125^\circ\text{C}$  max.
- Product reliability results are valid for  $T_j = 150^\circ\text{C}$
- SC data:  $t_p \leq 6 \mu\text{s}$ ;  $V_{CE} \leq 15 \text{ V}$ ;  $T_j = 150^\circ\text{C}$ ,  $V_{CC} = 360 \text{ V}$
- $V_{CEsat}$ ,  $V_F = \text{chip level}$

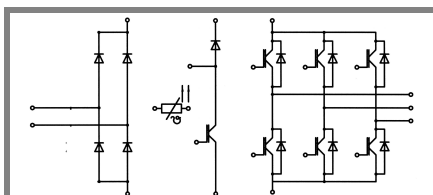

NEB

Absolute Maximum Ratings		$T_S = 25^\circ\text{C}$ , unless otherwise specified	
Symbol	Conditions	Values	Units
<b>IGBT - Inverter, Chopper</b>			
$V_{CES}$		600	V
$I_C$	$T_S = 25 (70)^\circ\text{C}$ , $T_j = 150^\circ\text{C}$	39 (27)	A
$I_C$	$T_S = 25 (70)^\circ\text{C}$ , $T_j = 175^\circ\text{C}$	43 (32)	A
$I_{CRM}$	$t_p = 1 \text{ ms}$	60	A
$V_{GES}$		$\pm 20$	V
<b>Diode - Inverter, Chopper</b>			
$I_F$	$T_S = 25 (70)^\circ\text{C}$ , $T_j = 150^\circ\text{C}$	33 (22)	A
$I_F$	$T_S = 25 (70)^\circ\text{C}$ , $T_j = 175^\circ\text{C}$	39 (29)	A
$I_{FRM}$	$t_p = 1 \text{ ms}$	60	A
<b>Diode - Rectifier</b>			
$V_{RRM}$		800	V
$I_F$	$T_S = 70^\circ\text{C}$	46	A
$I_{FSM}$	$t_p = 10 \text{ ms}$ , $\sin 180^\circ$ , $T_j = 25^\circ\text{C}$	370	A
$i^2t$	$t_p = 10 \text{ ms}$ , $\sin 180^\circ$ , $T_j = 25^\circ\text{C}$	680	$\text{A}^2\text{s}$
$I_{tRMS}$	per power terminal (20 A / spring)	40	A
$T_j$	IGBT, Diode	-40...+175	$^\circ\text{C}$
$T_{stg}$		-40...+125	$^\circ\text{C}$
$V_{isol}$	AC, 1 min.	2500	V

Characteristics		$T_S = 25^\circ\text{C}$ , unless otherwise specified			
Symbol	Conditions	min.	typ.	max.	Units
<b>IGBT - Inverter, Chopper</b>					
$V_{CE(sat)}$	$I_{Cnom} = 30 \text{ A}$ , $T_j = 25 (150)^\circ\text{C}$	1,45 (1,65)	1,85 (2,05)		V
$V_{GE(th)}$	$V_{GE} = V_{CE}$ , $I_C = 1 \text{ mA}$	5,8			V
$V_{CE(TO)}$	$T_j = 25 (150)^\circ\text{C}$	0,9 (0,85)	1 (0,9)		V
$r_{CE}$	$T_j = 25 (150)^\circ\text{C}$	18 (27)	28 (38)		$\text{m}\Omega$
$C_{ies}$	$V_{CE} = 25 \text{ V}$ , $V_{GE} = 0 \text{ V}$ , $f = 1 \text{ MHz}$	1,6			nF
$C_{oes}$	$V_{CE} = 25 \text{ V}$ , $V_{GE} = 0 \text{ V}$ , $f = 1 \text{ MHz}$	0,19			nF
$C_{res}$	$V_{CE} = 25 \text{ V}$ , $V_{GE} = 0 \text{ V}$ , $f = 1 \text{ MHz}$	0,17			nF
$R_{CC+EE'}$	spring contact-chip $T_S = 25 (150)^\circ\text{C}$				$\text{m}\Omega$
$R_{th(j-s)}$	per IGBT	1,35			K/W
$t_{d(on)}$	under following conditions	20			ns
$t_r$	$V_{CC} = 300 \text{ V}$ , $V_{GE} = -8\text{V} / 15 \text{ V}$	20			ns
$t_{d(off)}$	$I_{Cnom} = 30 \text{ A}$ , $T_j = 150^\circ\text{C}$	200			ns
$t_f$	$R_{Gon} = R_{Goff} = 12 \Omega$	45			ns
$E_{on} (E_{off})$	inductive load	0,9 (1,2)			mJ
<b>Diode - Inverter, Chopper</b>					
$V_F = V_{EC}$	$I_F = 30 \text{ A}$ , $T_j = 25 (150)^\circ\text{C}$	1,5 (1,5)	1,7 (1,7)		V
$V_{(TO)}$	$T_j = 25 (150)^\circ\text{C}$	1 (0,9)			V
$r_T$	$T_j = 25 (150)^\circ\text{C}$	16,7 (20)			$\text{m}\Omega$
$R_{th(j-s)}$	per diode	2,1			K/W
$I_{RRM}$	under following conditions	46,3			A
$Q_{rr}$	$I_{Fnom} = 30 \text{ A}$ , $V_R = 300 \text{ V}$	4			$\mu\text{C}$
$E_{rr}$	$V_{GE} = 0 \text{ V}$ , $T_j = 150^\circ\text{C}$ $di_F/dt = 1880 \text{ A}/\mu\text{s}$	1,1			mJ
<b>Diode - Rectifier</b>					
$V_F$	$I_{Fnom} = 25 \text{ A}$ , $T_j = 25^\circ\text{C}$	1,1			V
$V_{(TO)}$	$T_j = 150^\circ\text{C}$	0,8			V
$r_T$	$T_j = 150^\circ\text{C}$	13			$\text{m}\Omega$
$R_{th(j-s)}$	per diode	1,5			K/W
<b>Temperature Sensor</b>					
$R_{ts}$	3 %, $T_r = 25 (100)^\circ\text{C}$	1000(1670)			$\Omega$
<b>Mechanical Data</b>					
w		65			g
$M_s$	Mounting torque	2	2,5		Nm

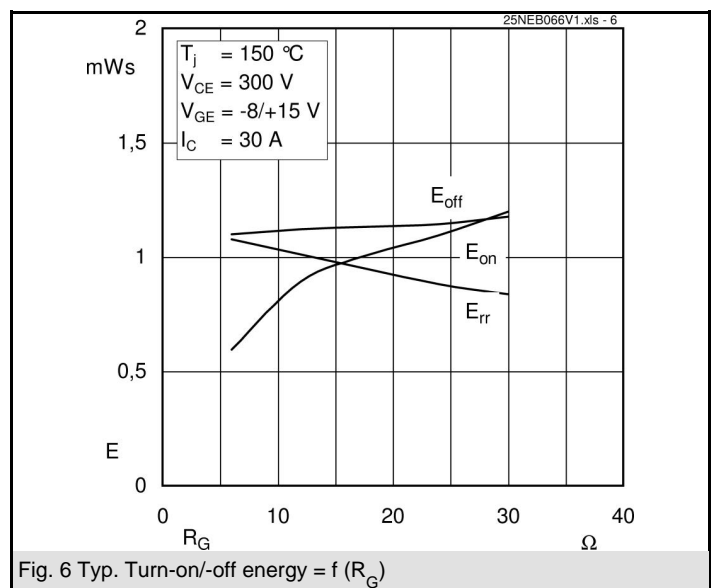
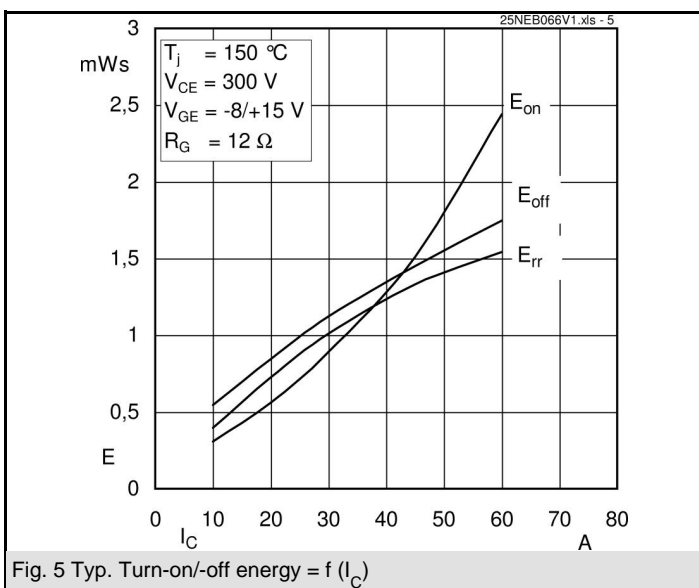
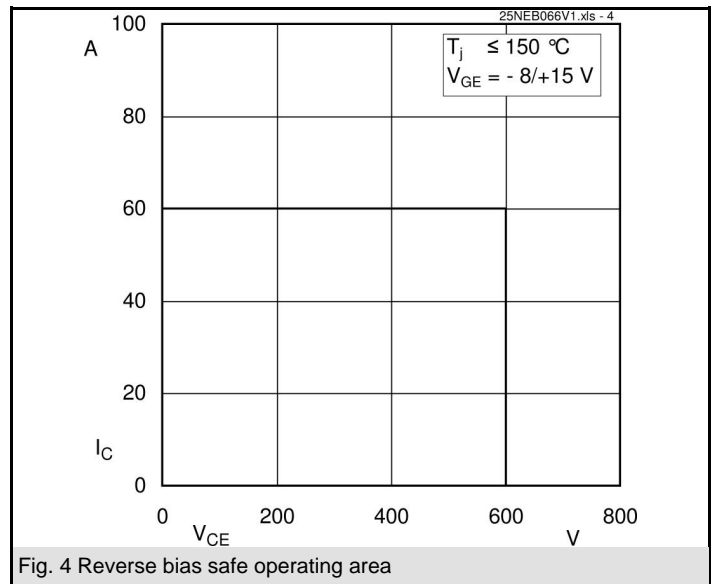
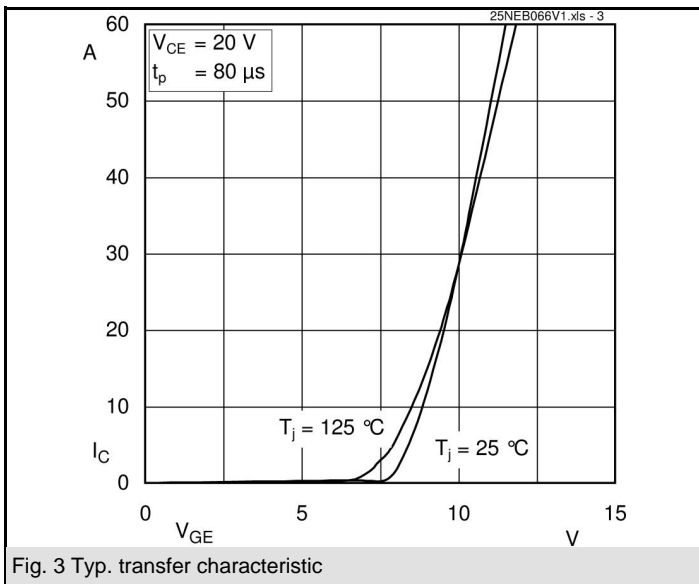
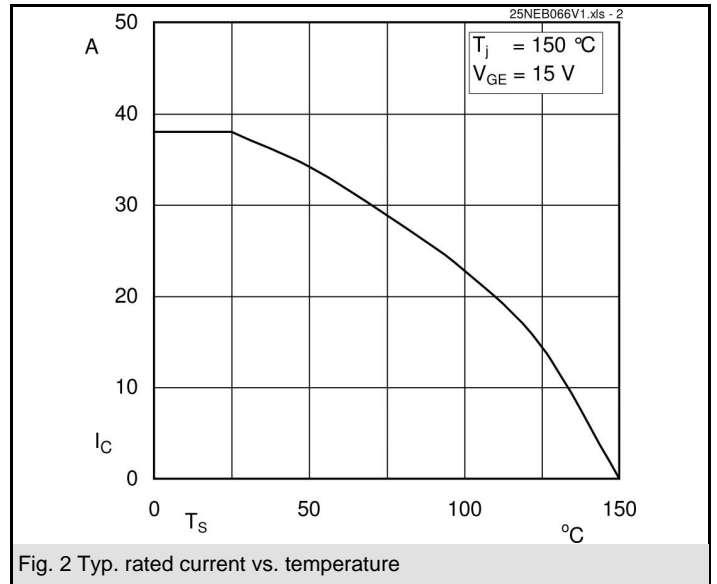
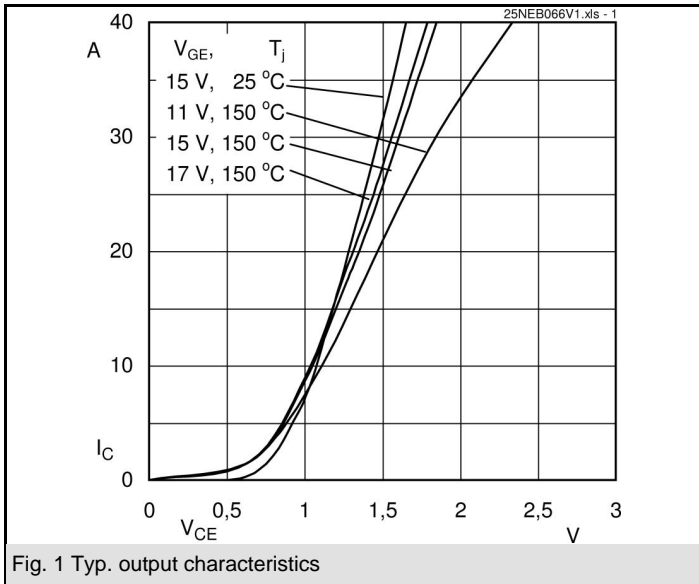

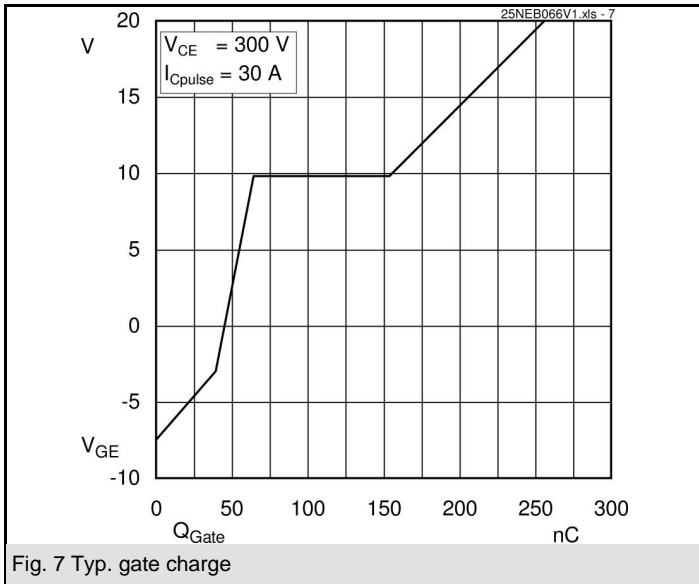

Fig. 7 Typ. gate charge

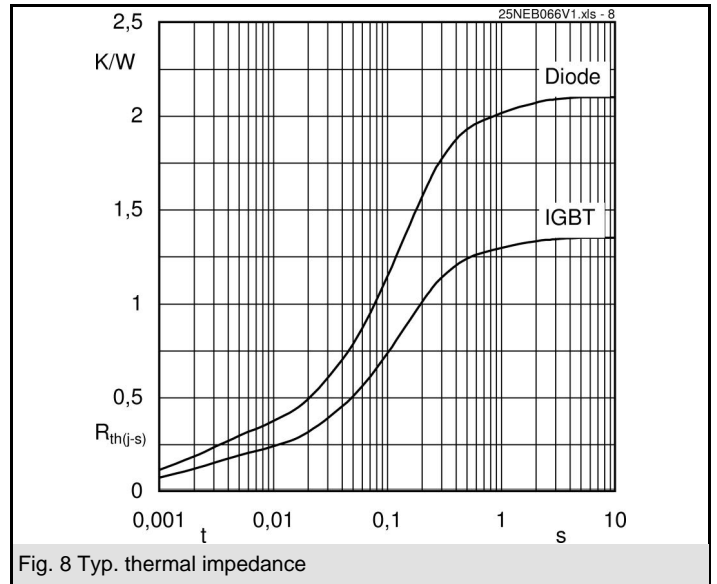

Fig. 8 Typ. thermal impedance

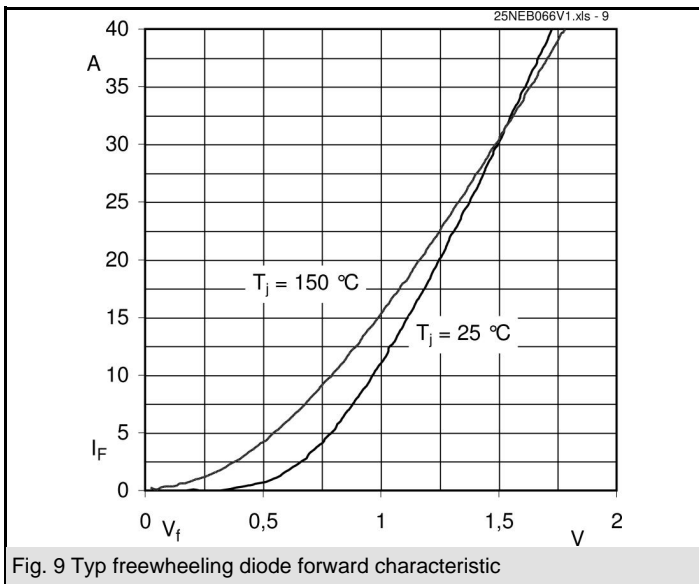

Fig. 9 Typ. freewheeling diode forward characteristic

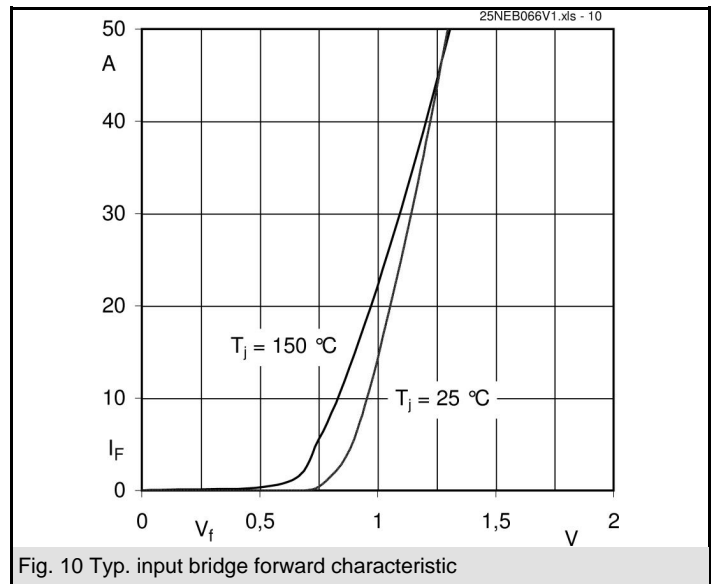
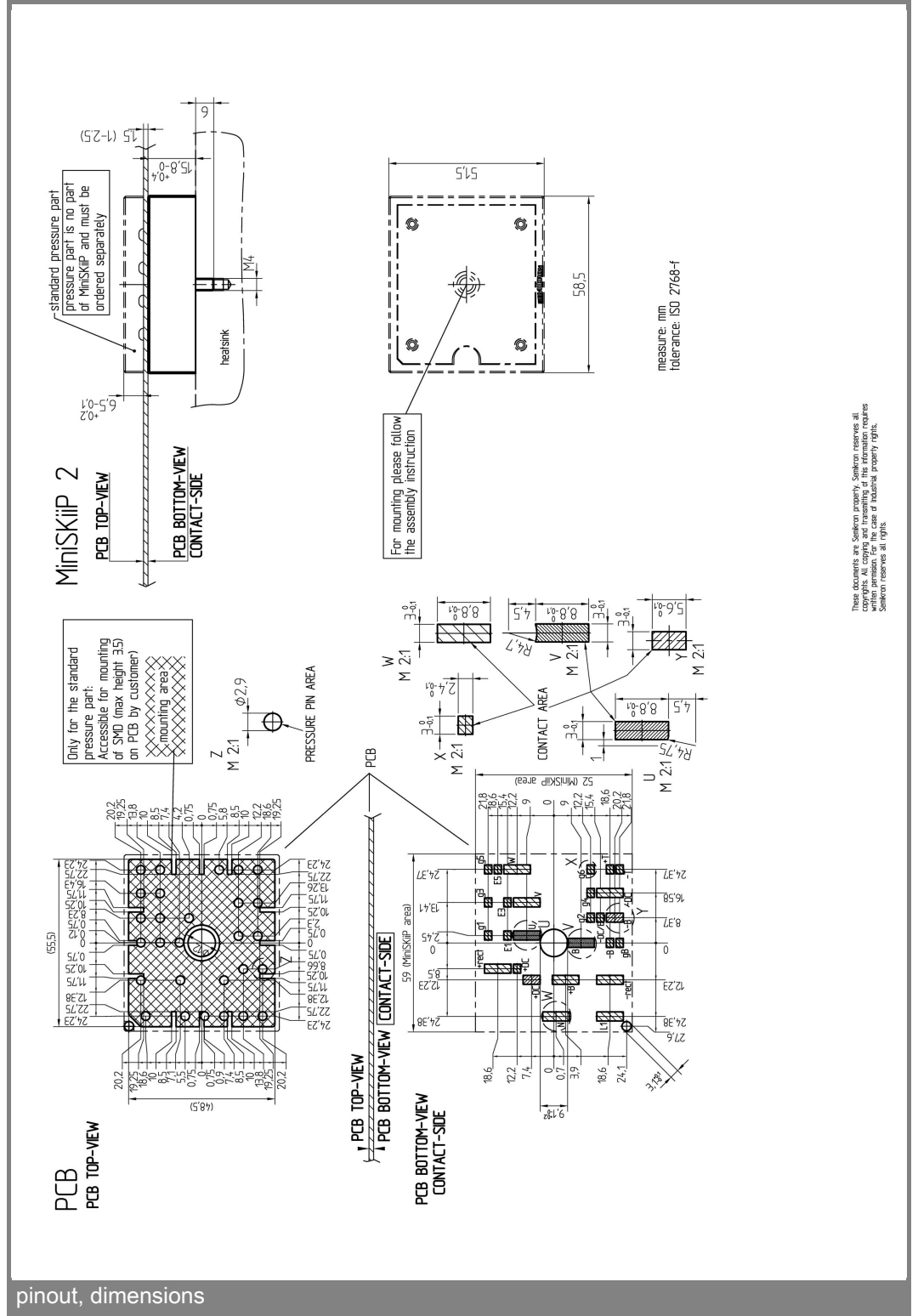
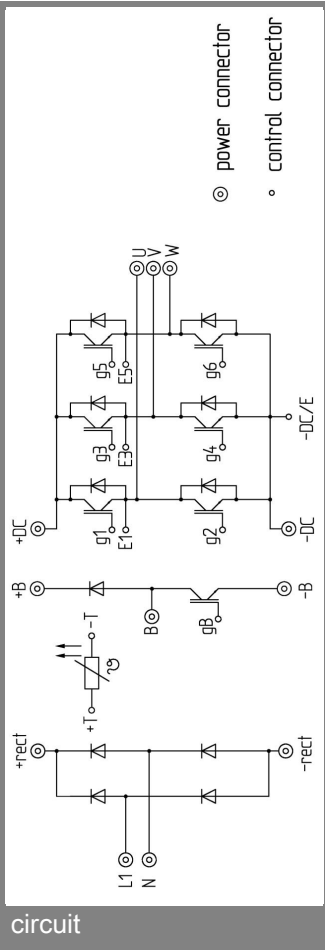

Fig. 10 Typ. input bridge forward characteristic



This is an electrostatic discharge sensitive device (ESDS), international standard IEC 60747-1, Chapter IX.

\* The specifications of our components may not be considered as an assurance of component characteristics. Components have to be tested for the respective application. Adjustments may be necessary. The use of SEMIKRON products in life support appliances and systems is subject to prior specification and written approval by SEMIKRON. We therefore strongly recommend prior consultation of our personal.